



2015

Integrated Resource Plan

Volume II - Appendices

*Let's turn the answers **on.***

March 31, 2015



Pacific Power
Rocky Mountain Power

This 2015 Integrated Resource Plan Report is based upon the best available information at the time of preparation. The IRP action plan will be implemented as described herein, but is subject to change as new information becomes available or as circumstances change. It is PacifiCorp's intention to revisit and refresh the IRP action plan no less frequently than annually. Any refreshed IRP action plan will be submitted to the State Commissions for their information.

For more information, contact:

PacifiCorp

IRP Resource Planning

825 N.E. Multnomah, Suite 600

Portland, Oregon 97232

(503) 813-5245

irp@pacificorp.com

<http://www.pacificorp.com>

This report is printed on recycled paper

Cover Photos (Top to Bottom):

Wind Turbine: Marengo II

Solar: Residential Solar Install

Transmission: Populus to Terminal Tower Construction

Demand-Side Management: Wattsmart Flower

Thermal-Gas: Lake Side I

TABLE OF CONTENTS

Table of Contents	i
Index of Tables	vi
Index of Figures.....	ix
Appendix A – Load Forecast Details.....	1
INTRODUCTION	1
<i>Summary Load Forecast</i>	<i>1</i>
LOAD FORECAST ASSUMPTIONS.....	4
<i>Regional Economy by Jurisdiction.....</i>	<i>4</i>
Utah.....	5
Oregon.....	6
Wyoming.....	7
Washington.....	7
Idaho.....	8
California	8
WEATHER	9
<i>Statistically Adjusted End-Use (SAE).....</i>	<i>10</i>
<i>Individual Customer Forecast.....</i>	<i>10</i>
<i>Actual Load Data</i>	<i>10</i>
<i>System Losses</i>	<i>12</i>
FORECAST METHODOLOGY OVERVIEW	12
<i>Class 2 Demand-side Management Resources in the Load Forecast</i>	<i>12</i>
<i>Modeling overview</i>	<i>12</i>
SALES FORECAST AT THE CUSTOMER METER.....	13
<i>Residential.....</i>	<i>14</i>
<i>Commercial</i>	<i>14</i>
<i>Industrial</i>	<i>14</i>
STATE SUMMARIES.....	15
Oregon.....	15
Washington.....	15
California	15
Utah.....	16
Idaho.....	16
Wyoming.....	17
ALTERNATIVE LOAD FORECAST SCENARIOS	17
Appendix B – IRP Regulatory Compliance.....	19
INTRODUCTION	19
GENERAL COMPLIANCE.....	19
California	20
Idaho.....	20
Oregon.....	21
Utah.....	21
Washington.....	21
Wyoming.....	22
Appendix C – Public Input Process.....	55
PARTICIPANT LIST	55
<i>Commissions and/or Commission Staff.....</i>	<i>56</i>
<i>Stakeholders and Industry Experts.....</i>	<i>56</i>

PUBLIC INPUT MEETINGS	57
<i>General Meetings</i>	57
June 5, 2014 – General Public Meeting	57
July 17-18, 2014 – General Public Meeting	58
August 7-8, 2014 – General Public Meeting.....	58
September 25-26, 2014 – General Public Meeting	58
November 14, 2014 – General Public Meeting.....	59
December 8, 2014 – Confidential Technical Workshop (Salt Lake City)	59
December 10, 2014 – Confidential Technical Workshop (Portland).....	59
January 29-30, 2015 – General Public Meeting.....	59
February 26, 2015 – General Public Meeting	59
<i>State Meetings</i>	59
June 10, 2014 – Washington State Stakeholder Meeting.....	59
June 18, 2014 – Utah State Stakeholder Meeting	59
June 19, 2014 – Wyoming State Stakeholder Meeting.....	59
June 26, 2014 – Oregon State Stakeholder Meeting.....	59
STAKEHOLDER COMMENTS	59
CONTACT INFORMATION	61
Appendix D – Demand-Side Management Resources	63
INTRODUCTION	63
DEMAND-SIDE RESOURCE POTENTIAL ASSESSMENTS FOR 2015-2034	63
DSM – ECONOMIC CLASS 2 DSM RESOURCE SELECTIONS – PREFERRED PORTFOLIO	64
DSM – STATE IMPLEMENTATION PLANS	64
<i>Background</i>	64
<i>DSM Resource Selections</i>	65
Class 1 DSM resources (dispatchable or scheduled firm capacity resources)	65
Class 2 DSM Resources (energy efficiency)	65
Class 3 DSM Resources (price responsive capacity resources).....	66
Class 4 DSM Resources (Customer Education of Efficient Energy Management).....	67
<i>Program Portfolio Offerings by State for DSM Resource Classes 1, 2, and 4</i>	67
<i>Estimated Expenditures by State and Year</i>	69
<i>State Specific Demand-Side Management Implementation Plans</i>	69
<i>2015 Demand-Side Management Communications and Outreach Plan</i>	71
Overview	71
Customer Communications Tactics (all states).....	72
Messaging	72
California	73
Oregon	74
Washington	75
Idaho	77
Utah.....	78
Wyoming	80
Communications and Outreach Budget	81
Appendix E – Smart Grid	83
INTRODUCTION	83
<i>Transmission System Efforts</i>	84
Dynamic Line Rating.....	84
Synchrophasors	84
<i>Distribution System Efforts</i>	84
Distribution Reliability Efforts: Communicating Faulted Circuit Indicators	84
<i>Customer Information and Demand-Side Management Efforts</i>	85
Advanced Metering Strategy	85
FUTURE SMART GRID	85

Appendix F – Flexible Resource Needs Assessment	87
INTRODUCTION	87
FLEXIBLE RESOURCE REQUIREMENTS FORECAST.....	87
<i>Contingency Reserve</i>	87
<i>Regulating Margin</i>	88
FLEXIBLE RESOURCE SUPPLY FORECAST.....	89
FLEXIBLE RESOURCE SUPPLY PLANNING.....	92
Appendix G – Plant Water Consumption.....	93
Appendix H – Wind Integration Study.....	97
INTRODUCTION	97
<i>Technical Review Committee</i>	98
<i>Executive Summary</i>	99
DATA	101
Historical Load Data	102
Historical Wind Generation Data.....	103
METHODOLOGY	105
<i>Method Overview</i>	105
Operating Reserves	105
Determination of Amount and Costs of Regulating Margin Requirements.....	106
<i>Regulating Margin Requirements</i>	107
Hypothetical Operational Forecasts	107
Analysis of Deviations	112
Back Casting	116
Application to Component Reserves	117
<i>Application of Regulating Margin Reserves in Operations</i>	120
<i>Determination of Wind Integration Costs</i>	120
SENSITIVITY STUDIES	123
Modeling Regulating Margin on a Monthly Basis.....	123
Separating Regulating and Following Reserves	125
ENERGY IMBALANCE MARKET (EIM).....	126
SUMMARY.....	128
EXHIBIT A - PACIFICORP 2014 WIND INTEGRATION STUDY TECHNICAL MEMO	130
<i>Background</i>	130
<i>TRC Process</i>	131
<i>Introduction</i>	132
<i>Analytical Methodology</i>	132
<i>Assumptions</i>	133
<i>Results</i>	133
<i>Discussion and Conclusions</i>	133
<i>Recommendations for Future Work</i>	134
<i>Concurrence provided by:</i>	134
Appendix I – Planning Reserve Margin Study.....	135
INTRODUCTION	135
METHODOLOGY	135
<i>Development of Resource Portfolios</i>	136
<i>Development of Reliability Metrics</i>	137
<i>Development of System Variable Costs</i>	137
<i>Calculating the Incremental Cost of Reliability</i>	138
RESULTS	138
<i>Resource Portfolios</i>	138
<i>Reliability Metrics</i>	138
<i>System Costs</i>	141

<i>Incremental Cost of Reliability</i>	142
CONCLUSION	143
Appendix J – Western Resource Adequacy Evaluation	145
INTRODUCTION	145
WESTERN ELECTRICITY COORDINATING COUNCIL RESOURCE ADEQUACY ASSESSMENT	145
PACIFIC NORTHWEST RESOURCE ADEQUACY FORUM’S ADEQUACY ASSESSMENT	149
CUSTOMER VERSUS SHAREHOLDER RISK ALLOCATION	149
Appendix K – Detail Capacity Expansion Results	151
PORTFOLIO CASE BUILD TABLES	151
Appendix L – Stochastic Production Cost Simulation Results	211
INTRODUCTION	211
Appendix M – Case Study Fact Sheets	245
CASE FACT SHEET OVERVIEW.....	245
CORE CASE FACT SHEETS	248
SENSITIVITY CASE FACT SHEETS	356
Appendix N – 2014 Wind and Solar Capacity Contribution Study	405
INTRODUCTION	405
METHODOLOGY	406
RESULTS	407
CONCLUSION	410
Appendix O – Distributed Generation Resource Assessment Study	411
INTRODUCTION	411
DISTRIBUTED GENERATION RESOURCE ASSESSMENT FOR LONG-TERM PLANNING STUDY	413
EXECUTIVE SUMMARY	419
INTRODUCTION	423
DG TECHNOLOGY DEFINITIONS	427
RESOURCE COST & PERFORMANCE ASSUMPTIONS.....	441
DG MARKET POTENTIAL AND BARRIERS.....	450
METHODOLOGY TO DEVELOP 2015 IRP DG PENETRATION FORECASTS	457
RESULTS	470
APPENDIX A. GLOSSARY	493
APPENDIX B. SUMMARY TABLE OF RESULTS.....	494
Appendix P – Anaerobic Digesters Resource Assessment Study	495
INTRODUCTION	495
ANAEROBIC DIGESTERS RESOURCE ASSESSMENT FOR PACIFICORP WASHINGTON SERVICE TERRITORY	497
SECTION 1 – EXECUTIVE SUMMARY.....	500
SECTION 2 – DIGESTER TECHNOLOGY.....	506
SECTION 3 – POWER PRODUCTION ESTIMATE	512
SECTION 4 – ENVIRONMENTAL AND REGULATORY	522
SECTION 5 – DEVELOPMENT COST	526
SECTION 6 – OPERATING COSTS.....	528
Appendix Q – Energy Storage Screening Study	531
TABLE OF CONTENTS	534
1. EXECUTIVE SUMMARY	538
2. INTRODUCTION	542
2.1 <i>Integrating Variable Energy Resources</i>	542
3. ENERGY STORAGE SYSTEMS AND TECHNOLOGY	544
3.1 <i>Pumped Storage</i>	544
3.2 <i>Batteries</i>	564

3.2 Compressed Air Energy Storage	579
3.5 Liquid Air Energy Storage	588
3.6 Supercapacitors.....	589
4. COMPARISON OF STORAGE TECHNOLOGIES	591
4.1 Technology Development	591
4.2 Applications.....	592
4.3 Space Requirements	592
4.4 Performance Characteristics	593
4.5 Project Timeline	595
4.6 Cost.....	595
5. CONCLUSIONS.....	597
References	598
Appendix R – Uncertainty Parameters Study.....	603

INDEX OF TABLES

Table A.1 – Forecasted Annual Load Growth, 2015 through 2024 (Megawatt-hours)	3
Table A.2 – Forecasted Annual Coincident Peak Load (Megawatts)	3
Table A.3 – Annual Load Growth Change: September 2014 Forecast less October 2013 Forecast (Megawatt-hours)	3
Table A.4 – Annual Coincident Peak Growth Change: September 2014 Forecast less October 2013 Forecast (Megawatts)	4
Table A.5 – Weather Normalized Jurisdictional Retail Sales 2000 through 2014	11
Table A.6 – Non-Coincident Jurisdictional Peak 2000 through 2014	11
Table A.7 – Jurisdictional Contribution to Coincident Peak 2000 through 2014	12
Table A.8 – System Annual Sales Forecast 2015 through 2024	14
Table A.9 – Forecasted Sales Growth in Oregon	15
Table A.10 – Forecasted Sales Growth in Washington	15
Table A.11 – Forecasted Retail Sales Growth in California	16
Table A.12 – Forecasted Retail Sales Growth in Utah	16
Table A.13 – Forecasted Retail Sales Growth in Idaho	17
Table A.14 – Forecasted Retail Sales Growth in Wyoming	17
Table B.1 – Integrated Resource Planning Standards and Guidelines Summary by State	23
Table B.2 – Handling of 2015 IRP Acknowledgment and Other IRP Requirements	28
Table B.3 – Oregon Public Utility Commission IRP Standard and Guidelines	36
Table B.4 – Utah Public Service Commission IRP Standard and Guidelines	45
Table B.5 – Washington Utilities and Transportation Commission IRP Standard and Guidelines (RCW 19.280.030 and WAC 480-100-238)	50
Table B.6 – Wyoming Public Service Commission IRP Standard and Guidelines (Docket 90000- 107-XO-09)	53
Table D.1 – Incremental and Cumulative Class 1 Resource Selections by State, Product and Year	65
Table D.2 – Existing Class 1 DSM resources (2015 Preferred Portfolio)	65
Table D.3 – Class 2 DSM Resources (2015 IRP Preferred Portfolio, Incremental Resources)	66
Table D.4 – Existing Program Services and Offerings by Sector and State	68
Table D.5 – Existing <i>wattsmart</i> Outreach and Communications Activities	69
Table D.6 – Preliminary DSM Program Budget, DSM Classes 1, 2 and 4 (\$000)	69
Table D.7 – DSM Implementation Items by Sector and State	70
Table F.1 – Reserve Requirements (MW)	89
Table F.2 – Flexible Resource Supply Forecast (MW)	90
Table G.1 – Plant Water Consumption with Acre-Feet Per Year	94
Table G.2 – Plant Water Consumption by State (acre-feet)	95
Table G.3 – Plant Water Consumption by Fuel Type (acre-feet)	95
Table G.4 – Plant Water Consumption for Plants Located in the Upper Colorado River Basin (acre- feet)	96
Table H.1 – 2012 WIS TRC Recommendations	98
Table H.2 – Average Annual Regulating Margin Reserves, 2011 – 2013 (MW)	100
Table H.3 – Wind Integration Cost, \$/MWh	100
Table H.4 – Historical Wind Production and Load Data Inventory	101
Table H.5 – Examples of Load Data Anomalies and their Interpolated Solutions	103
Table H.6 – Percentiles Dividing the June 2013 East Load Regulating Forecasts into 20 Bins	113
Table H.7 – Recorded Interval Load Regulating Forecasts and their Respective Deviations for June 2013 Operational Data from PACE	114
Table H.8 – Sample Reference Table for East Load and Wind Following Component Reserves (MW)	116
Table H.9 – Sample Reference Table for East Load and Wind Regulating Component Reserves	117
Table H.10 – Load Forecasts and Component Reserve Requirement Data for Hour-ending 11:00 a.m. June 1, 2013 in PACE	118

Table H.11 – Interval Wind Forecasts and Component Reserve Requirement Data for Hour-ending 11 a.m. June 1, 2013 in PACE	118
Table H.12 – Wind Integration Cost Simulations in PaR	121
Table H.13 – Wind Integration Cost Simulations in PaR, 2012 WIS	123
Table H.14 – 2014 Wind Integration Costs, \$/MWh	123
Table H.15 – Comparison of Wind Integration Costs Calculated Using Monthly and Hourly Reserve Requirements as Inputs to PaR, (\$/MWh)	124
Table H.16 – Average Natural Gas and Electricity Prices Used in the 2012 and 2014 Wind Integration Studies	124
Table H.17 – Total Load and Wind Monthly Reserves, Separating Regulating and Following Reserves (MW)	126
Table H.18 – Estimated Reduction in PacifiCorp’s Regulating Margin Due to EIM	128
Table H.19 – Wind Integration Cost with and without EIM Benefit, \$/MWh	128
Table H.20 – Regulating Margin Requirements Calculated for PacifiCorp’s System (MW)	129
Table H.21 – 2014 WIS Wind Integration Costs as Compared to 2012 WIS, \$/MWh	129
Table I.1 – Expansion Resources Additions by PRM	138
Table I.2 – Expected Reliability Metrics by PRM	139
Table I.3 – Fitted Reliability Metrics by PRM	139
Table I.4 – System Variable, Up-front Capital, and Run-rate Fixed Costs by PRM	141
Table I.5 – Incremental Cost of Reliability by PRM	142
Table J.1 – 2012 WECC Forecasted Planning Reserve Margins	148
Table K.1 – Core Case Study Reference Guide	151
Table K.2 – Sensitivity Case Study Reference Guide	152
Table K.3 – East-Side Resource Name and Description	153
Table K.4 – West-Side Resource Name and Description	155
Table K.5 – Core Case System Optimizer Results	157
Table K.6 – Sensitivity Case System Optimizer Results	158
Table K.7 – Core Cases, Detailed Capacity Expansion Portfolios	159
Table K.8 – Sensitivity Cases, Detailed Capacity Expansion Portfolios	193
Table L.1 – Stochastic Mean PVRR (\$m) by Price Scenario, Core Cases	216
Table L.2 – Stochastic Mean PVRR (\$m) by Price Scenario, Sensitivity Cases	217
Table L.3 – Stochastic Risk Results, PVRR (\$m), Core Cases, Low Price Curve	218
Table L.4 – Stochastic Risk Results, PVRR (\$m), Core Cases, Base Price Curve	219
Table L.5 – Stochastic Risk Results, PVRR (\$m), Core Cases, High Price Curve	220
Table L.6 – Stochastic Risk Results, PVRR (\$m), Core Cases, High CO ₂ Price Curve	221
Table L.7 – Stochastic Risk Results, PVRR (\$m), Sensitivity Cases, Low Price Curve	222
Table L.8 – Stochastic Risk Results, PVRR (\$m), Sensitivity Cases, Base Price Curve	222
Table L.9 – Stochastic Risk Results, PVRR (\$m), Sensitivity Cases, High Price Curve	223
Table L.10 – Stochastic Risk Adjusted PVRR (\$m) by Price Scenario, Core Cases	224
Table L.11 – Stochastic Risk Adjusted PVRR (\$m) by Price Scenario, Sensitivity Cases	225
Table L.12 – Carbon Dioxide Emissions (Thousand Tons) by Price Scenario, Core Cases	226
Table L.13 – Carbon Dioxide Emissions (Thousand Tons) by Price Scenario, Sensitivity Cases	227
Table L.14 – Average Annual Energy Not Served (2015 – 2034), Core Cases, Low Price Curve	228
Table L.15 – Average Annual Energy Not Served (2015 – 2034), Core Cases, Base Price Curve	229
Table L.16 – Average Annual Energy Not Served (2015 – 2034), Core Cases, High Price Curve	230
Table L.17 – Average Annual Energy Not Served (2015 – 2034), Core Cases, High CO ₂ Price Curve ..	231
Table L.18 – Average Annual Energy Not Served (2015 – 2034), Sensitivity Cases, Low Price Curve .	232
Table L.19 – Average Annual Energy Not Served (2015 – 2034), Sensitivity Cases, Base Price Curve	232
Table L.20 – Average Annual Energy Not Served (2015 – 2034), Sensitivity Cases, Price Curve	233
Table L.21 – Portfolio PVRR (\$m) Cost Components, Core Cases, Low Price Curve	235
Table L.22 – Portfolio PVRR (\$m) Cost Components, Core Cases, Base Price Curve	236
Table L.23 – Portfolio PVRR (\$m) Cost Components, Core Cases, High Price Curve	237
Table L.24 – Portfolio PVRR (\$m) Cost Components, Core Cases, High CO ₂ Price Curve	238

Table L.25 – Portfolio PVRR (\$m) Cost Components, Sensitivity Cases, Low Price Curve.....	239
Table L.26 – Portfolio PVRR (\$m) Cost Components, Sensitivity Cases, Base Price Curve	240
Table L.27 – Portfolio PVRR (\$m) Cost Components, Sensitivity Cases, High Price Curve	241
Table L.28 –10-year Average Incremental Customer Rate Impact (\$m), Final Screen Portfolios	242
Table L.29 – Loss of Load Probability for a Major (> 25,000 MWh) July Event, Final Screen Portfolios, Base Price Curve	242
Table L.30 – Average Loss of Load Probability during Summer Peak, Final Screen Portfolios, Base Price Curve.....	243
Table N.1 – Peak Capacity Contribution Values for Wind and Solar	405
Table N.2 – Peak Capacity Contribution Values for Wind and Solar	407

INDEX OF FIGURES

Figure A.1 – PacifiCorp System Energy Load Forecast Change.....	2
Figure A.2 – PacifiCorp System Peak Forecast Change.....	2
Figure A.3 – PacifiCorp Annual Retail Sales 2000 through 2014 and Western Region Employment.....	4
Figure A.4 – PacifiCorp Annual Residential Use per Customer 2001 through 2014.....	5
Figure A.5 – IHS Global Insight Utah Household and Employment forecasts from the October 2013 load forecast and the September 2014 load forecast.....	6
Figure A.6 – IHS Global Insight Oregon Household and Employment forecasts from the October 2013 load forecast and the September 2014 load forecast.....	6
Figure A.7 – IHS Global Insight Wyoming Household and Employment forecasts from the October 2013 load forecast and the September 2014 load forecast.....	7
Figure A.8 – IHS Global Insight Washington Household and Employment forecasts from the October 2013 load forecast and the September 2014 load forecast.....	8
Figure A.9 – IHS Global Insight Washington Household and Employment forecasts from the October 2013 load forecast and the September 2014 load forecast.....	8
Figure A.10 – IHS Global Insight California Household and Employment forecasts from the October 2013 load forecast and the September 2014 load forecast.....	9
Figure A.11 – Comparison of Utah 5, 10, and 20 Year Average Peak Producing Temperatures.....	9
Figure A.12 – Load Forecast Scenarios for 1-in-20 Weather, High, Base Case and Low.....	18
Figure F.1 – Comparison of Reserve Requirements and Resources, East Balancing Authority Area (MW).....	91
Figure F.2 – Comparison of Reserve Requirements and Resources, West Balancing Authority Area (MW).....	91
Figure H.1 – Representative Map, PacifiCorp Wind Generating Stations Used in this Study.....	104
Figure H.2 – Illustrative Load Following Forecast and Deviation.....	109
Figure H.3 – Illustrative Wind Following Forecast and Deviation.....	110
Figure H.4 – Illustrative Load Regulating Forecast and Deviation.....	111
Figure H.5 – Illustrative Wind Regulating Forecast and Deviation.....	112
Figure H.6 – Histogram of Deviations Occurring About a June 2013 PACE Load Regulating Forecast between 5,568 MW and 5,720 MW (Bin 14).....	115
Figure H.7 – Average Hourly Wind Reserves for 2013, MW.....	125
Figure H.8 – Energy Imbalance Market.....	127
Figure I.1 – Workflow for Planning Reserve Margin Study.....	136
Figure I.2 – Expected and Fitted Relationship of EUE to PRM.....	140
Figure I.3 – Expected and Fitted Relationship of LOLH to PRM.....	140
Figure I.4 – Simulated Relationship of Loss of Load Episode to PRM.....	141
Figure I.5 – Incremental Cost of Reliability by PRM.....	142
Figure J.1 – WECC Forecasted Power Supply Margins, 2007 to 2014.....	147
Figure J.2 – 2014 less 2012 WECC PSA.....	148
Figure L.1 – Stochastic Risk Profile under Regional Haze Scenarios 1 and 3, Low Price.....	212
Figure L.2 – Stochastic Risk Profile under Regional Haze Scenarios 1 and 3, Base Price.....	212
Figure L.3 – Stochastic Risk Profile under Regional Haze Scenarios 1 and 3, High Price.....	213
Figure L.4 – Stochastic Risk Profile under Regional Haze Scenario 2, Low Price.....	213
Figure L.5 – Stochastic Risk Profile under Regional Haze Scenario 2, Base Price.....	214
Figure L.6 – Stochastic Risk Profile under Regional Haze Scenario 2, High Price.....	214
Figure L.7 – Stochastic Risk Profile, High CO ₂	215
Figure N.1 – Daily LOLP.....	408
Figure N.2 – Monthly Resource Capacity Factors as Compared to LOLP.....	408
Figure N.3 – Hourly Resource Capacity Factors as Compared to LOLP for an Average Day in April.....	409
Figure N.4 – Hourly Resource Capacity Factors as Compared to LOLP for an Average Day in July.....	409
Figure N.5 – Hourly Resource Capacity Factors as Compared to LOLP for an Average Day in December.....	410

APPENDIX A – LOAD FORECAST DETAILS

Introduction

This appendix reviews the load forecast used in the modeling and analysis of the 2015 Integrated Resource Plan (“IRP”), including scenario development for case sensitivities. The load forecast used in the IRP is an estimate of the energy sales, and peak demand over a 20-year period. The 20-year horizon is important to anticipate electricity demand in order to develop timely response of resources.

In the development of its load forecast PacifiCorp employs econometric models that use historical data and inputs such as regional and national economic growth, weather, seasonality, and other customer usage and behavior changes. The forecast is divided into classes that use energy for similar purposes and at comparable retail rates. The classes are modeled separately using variables specific to their usage patterns. For residential customers, typical energy uses include space heating, water heating, lighting, cooking, refrigeration, dish washing, laundry washing, televisions and various other end use appliances. Commercial and industrial customers use energy for production and manufacturing processes, space heating, air conditioning, lighting, computers and other office equipment.

Jurisdictional peak load forecasts are developed using econometric equations that relate observed monthly peak loads, peak load producing weather and the weather-sensitive loads for all classes. The system coincident peak forecast, which is used in portfolio development, is the maximum load required on the system in any hourly period and is extracted from the hourly forecast model.

Summary Load Forecast

The Company updated its load forecast in September 2014. The average annual energy growth rate for the 10-year period (2015 through 2024) is 0.85 percent, with the average peak growth at 0.89 percent. Relative to the load forecast prepared for the 2013 IRP update, PacifiCorp’s 2024 energy forecast decreased in all jurisdictions and system energy requirements decreased approximately 3.2 percent. Likewise, peak forecasts are down, or flat across all jurisdictions as compared to the 2013 IRP Update. Figures A.1 and A.2 have comparisons of energy and peak forecasts respectively from the 2013 IRP (July 2012), 2013 IRP Update (October 2013) and the 2015 IRP (September 2014).

Figure A.1 – PacifiCorp System Energy Load Forecast Change

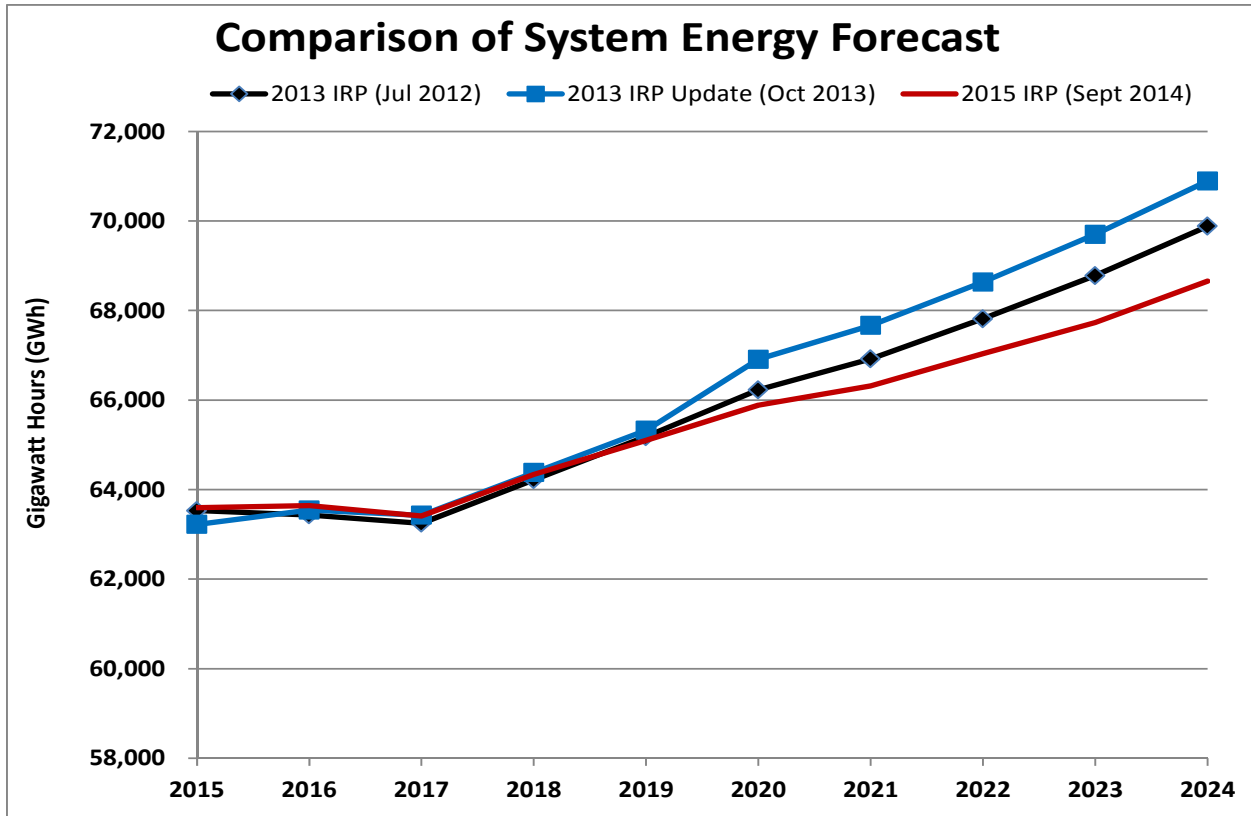
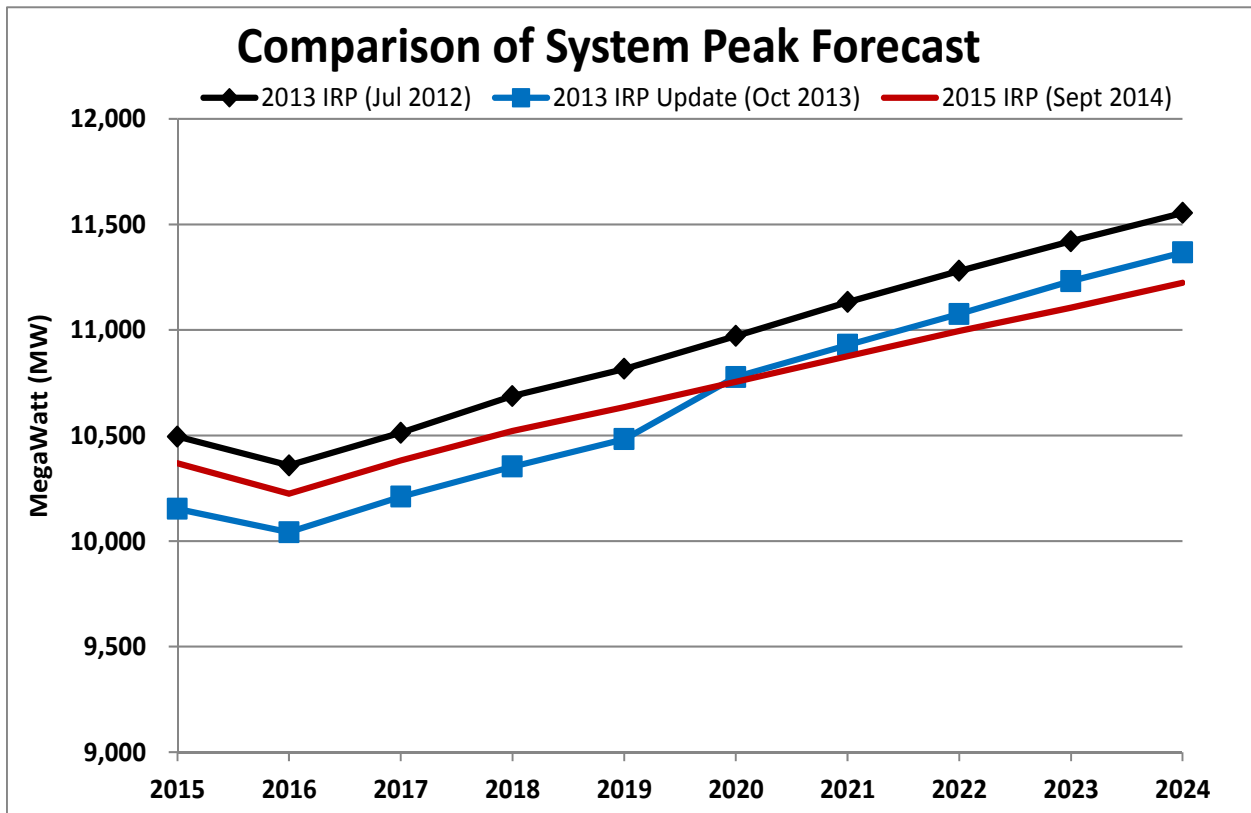

Figure A.2 – PacifiCorp System Peak Forecast Change



Tables A.1 and A.2 show the annual load and coincident peak load forecast excluding load reduction projections from new energy efficiency measures (Class 2 DSM).¹ Tables A.3 and A.4 show the forecast changes relative to the 2013 IRP update load forecast for loads and coincident system peak, respectively.

Table A.1 – Forecasted Annual Load Growth, 2015 through 2024 (Megawatt-hours)

Year	Total	OR	WA	CA	UT	WY	ID	SE-ID
2015	63,594,000	15,055,940	4,546,380	897,240	26,470,940	10,597,730	3,762,400	2,263,370
2016	63,644,160	15,197,090	4,604,260	903,780	27,119,080	10,879,850	3,787,070	1,153,030
2017	63,414,410	15,340,670	4,632,780	906,110	27,727,030	11,000,420	3,807,400	
2018	64,335,670	15,477,180	4,667,630	909,820	28,297,970	11,150,420	3,832,650	
2019	65,099,110	15,626,100	4,700,270	912,960	28,789,180	11,210,330	3,860,270	
2020	65,882,150	15,751,620	4,731,330	914,010	29,245,590	11,352,800	3,886,800	
2021	66,317,890	15,808,060	4,736,960	912,370	29,595,670	11,358,260	3,906,570	
2022	67,038,440	15,932,470	4,759,830	914,420	30,038,620	11,459,580	3,933,520	
2023	67,731,040	16,087,420	4,784,020	916,660	30,491,320	11,489,280	3,962,340	
2024	68,656,720	16,271,900	4,822,220	921,460	31,023,270	11,620,590	3,997,280	
Average Annual Growth Rate for 2013-2022								
2015-2024	0.85%	0.87%	0.66%	0.30%	1.78%	1.03%	0.68%	

Table A.2 – Forecasted Annual Coincident Peak Load (Megawatts)

Year	Total	OR	WA	CA	UT	WY	ID	SE-ID
2015	10,368	2,329	731	148	4,770	1,372	687	331
2016	10,225	2,354	737	150	4,881	1,400	702	
2017	10,381	2,383	742	151	4,985	1,415	706	
2018	10,522	2,404	750	152	5,076	1,431	710	
2019	10,635	2,426	752	152	5,153	1,439	713	
2020	10,755	2,451	758	151	5,234	1,453	708	
2021	10,876	2,472	761	152	5,313	1,456	722	
2022	10,996	2,494	765	153	5,389	1,468	727	
2023	11,105	2,517	769	154	5,462	1,472	732	
2024	11,224	2,536	773	154	5,540	1,486	735	
Average Annual Growth Rate for 2013-2022								
2015-2024	0.89%	0.95%	0.62%	0.41%	1.68%	0.89%	0.76%	

Table A.3 – Annual Load Growth Change: September 2014 Forecast less October 2013 Forecast (Megawatt-hours)

Year	Total	OR	WA	CA	UT	WY	ID	SE-ID
2015	373,230	(133,280)	28,180	1,130	441,250	17,880	18,070	-
2016	101,140	(133,390)	36,650	1,410	54,900	80,730	9,760	51,080
2017	(11,630)	(183,100)	39,860	2,210	65,380	56,920	7,100	-
2018	(43,330)	(177,400)	36,750	2,320	43,290	47,240	4,470	-
2019	(226,250)	(168,110)	31,380	1,760	(36,240)	(57,880)	2,840	-
2020	(1,027,540)	(206,720)	15,950	(1,930)	(727,930)	(103,730)	(3,180)	-
2021	(1,347,880)	(230,220)	(10)	(4,480)	(891,830)	(214,150)	(7,190)	-
2022	(1,598,130)	(243,850)	(12,730)	(6,210)	(1,064,760)	(260,230)	(10,350)	-
2023	(1,969,980)	(249,430)	(25,340)	(7,850)	(1,292,670)	(381,130)	(13,560)	-
2024	(2,234,000)	(249,400)	(38,210)	(9,300)	(1,486,080)	(433,810)	(17,200)	-

¹ Class 2 DSM load reductions are included as resources in the System Optimizer model.

Table A.4 – Annual Coincident Peak Growth Change: September 2014 Forecast less October 2013 Forecast (Megawatts)

Year	Total	OR	WA	CA	UT	WY	ID	SE-ID
2015	216	(9)	(7)	2	196	36	(4)	1
2016	183	(3)	(6)	2	151	43	(4)	
2017	172	(12)	(7)	2	157	37	(5)	
2018	170	(12)	(8)	2	161	35	(6)	
2019	152	(12)	(8)	2	155	24	(8)	
2020	(22)	(14)	(10)	1	(10)	20	(10)	
2021	(53)	(16)	(12)	1	(21)	6	(11)	
2022	(80)	(18)	(13)	1	(38)	0	(12)	
2023	(127)	(21)	(14)	1	(65)	(13)	(14)	
2024	(143)	(21)	(16)	1	(76)	(16)	(15)	

Load Forecast Assumptions

Regional Economy by Jurisdiction

The PacifiCorp electric service territory is comprised of six states and within these states the Company serves a total of 90 counties.

The level of retail sales for each state and county is correlated with economic conditions and population statistics in each state. The Company uses both economic data, such as employment, and population information, such as household data, to forecast its retail sales.

Looking at historical sales and employment data for PacifiCorp’s service territory, 2000 through 2014, in Figure A.3, it is apparent that the Company’s retail sales are correlated to economic conditions in its service territory, and most recently the 2008-2009 recession.

Figure A.3 – PacifiCorp Annual Retail Sales 2000 through 2014 and Western Region Employment

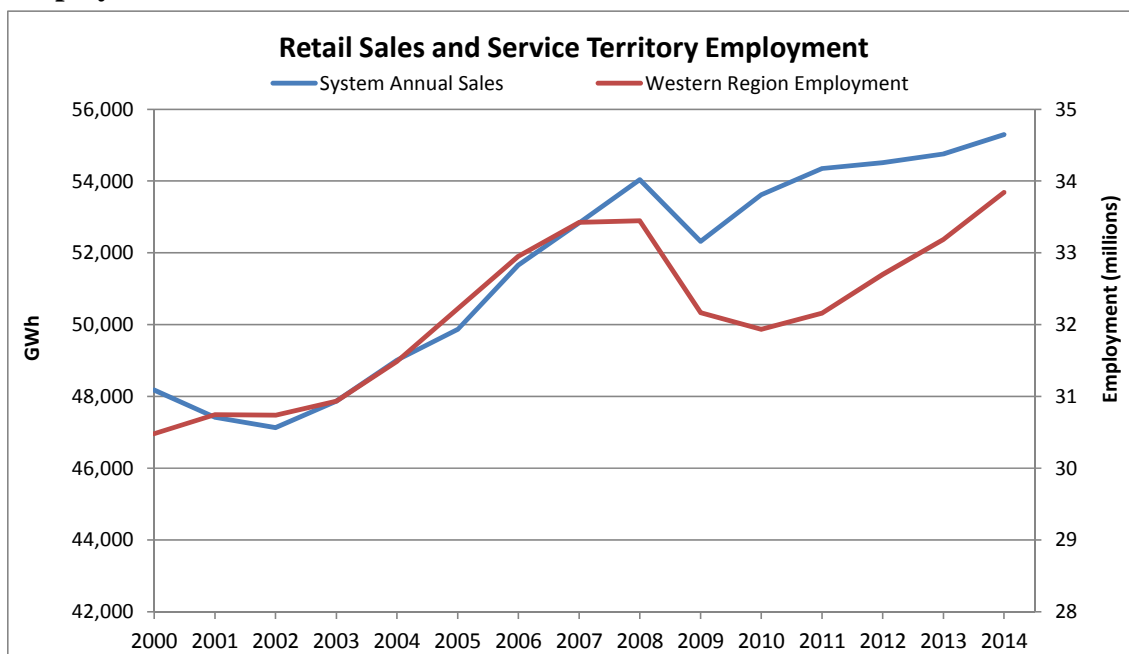

Sources: PacifiCorp and United States Department of Labor, Bureau of Labor Statistics

As discussed below, although both the economic and demographic forecast is relatively unchanged from the 2013 IRP Update, the load forecast has decreased. There are two changes which are driving the 2015 IRP load and peak forecast down. First, the relationship between the economic growth and sales has “flattened.” Second, there have been changes in expected sales to our largest customers.

Since the Great Recession that occurred in 2008-2009, the relationship between electric usage and economic growth has changed. While there is still a relationship between electric usage and the economic growth, electric usage has generally become less responsive to economic changes and has resulted in a lower usage forecast.

Residential use per customer has been decreasing since 2010. Figure A.4 shows the weather normalized average system residential use per customer.

Figure A.4 – PacifiCorp Annual Residential Use per Customer 2001 through 2014

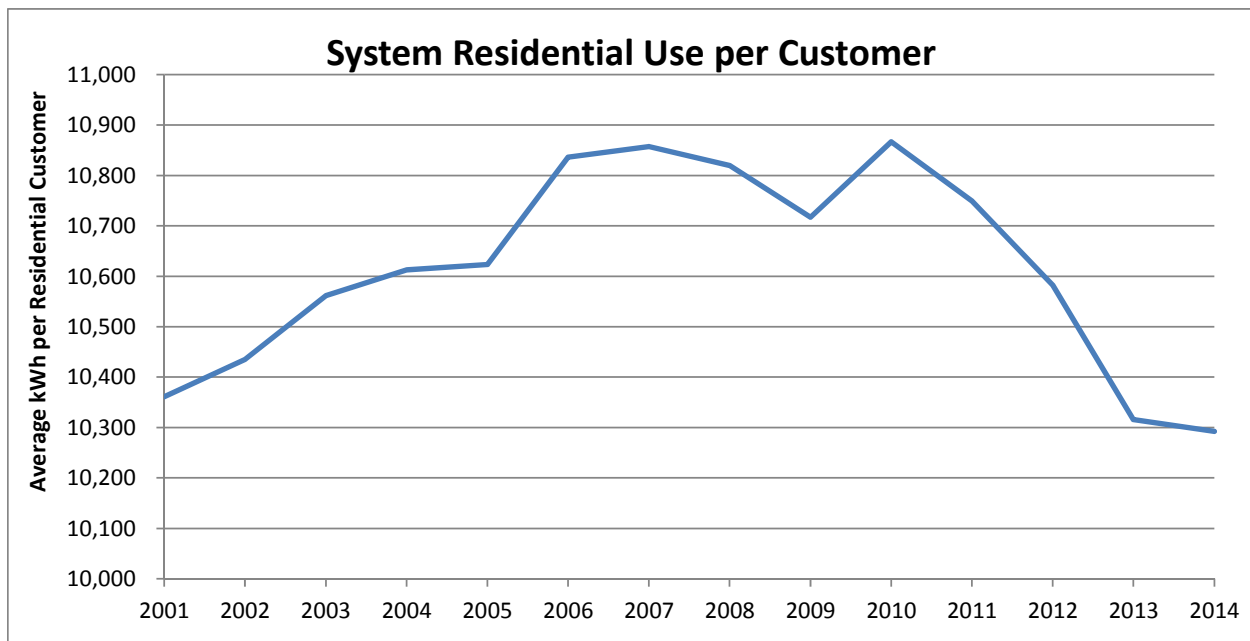

Residential use per customer across all six of PacifiCorp’s states is changing due to increased energy efficiency driven primarily by lighting efficiency standards resulting from the 2007 Federal Energy legislation. In addition, there has been a shift from single-family and manufactured housing to multi-dwelling units and a trend of replacing older electric appliances with more energy efficient appliances.

Utah

PacifiCorp serves 26 of the 29 counties in the state of Utah. Utah is expected to be one of the leading states in terms of job growth, with non-farm employment increasing 2.0 percent annually over the next 10 years. Figure A.5 shows the change in household and employment forecasts for the 2013 IRP Update relative to the 2015 IRP forecast. This figure illustrates that both the economic and demographic forecasts are very similar. Relative to the load forecast prepared for the 2013 IRP update, the Utah 2024 energy forecast decreased approximately 4.6 percent.

Figure A.5 – IHS Global Insight Utah Household and Employment forecasts from the October 2013 load forecast and the September 2014 load forecast

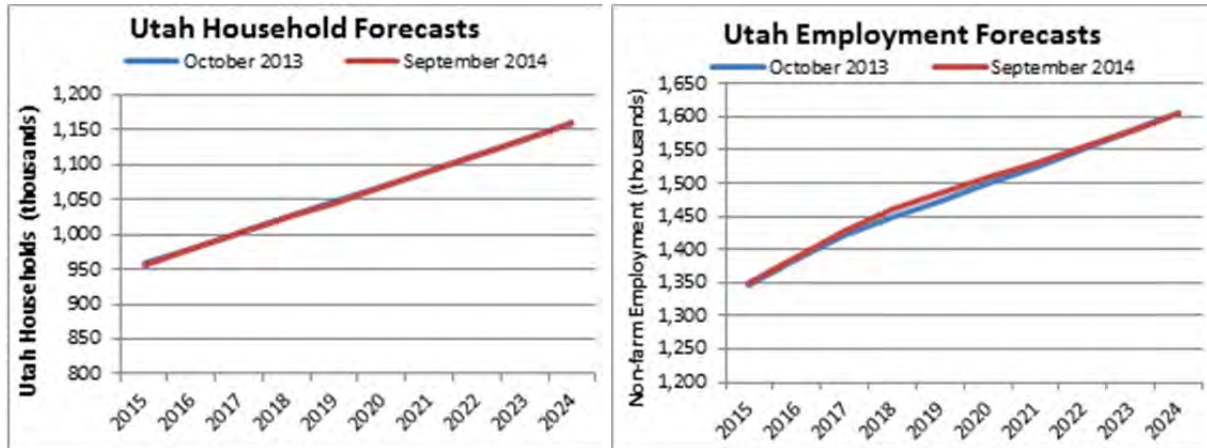

A risk to the Utah forecast is commodity prices, such as oil and natural gas, where volatility in prices and profitability can lead to swings in production and employment potentially translating to swings in the retail sales forecast.

Oregon

PacifiCorp serves 25 of the 36 counties in Oregon, but only 28 percent of ultimate electric retail sales in the state of Oregon.² In 2013 and 2014, Oregon employment growth has outpaced the national economy by approximately one percentage point.³ Figure A.6 shows the change in household and employment forecasts for the 2013 IRP Update relative to the 2015 IRP forecast. This figure illustrates that the forecast of households has decreased slightly, while the employment forecast has increased slightly. Relative to the load forecast prepared for the 2013 IRP update, the Oregon 2024 energy forecast decreased approximately 1.5 percent.

Figure A.6 – IHS Global Insight Oregon Household and Employment forecasts from the October 2013 load forecast and the September 2014 load forecast

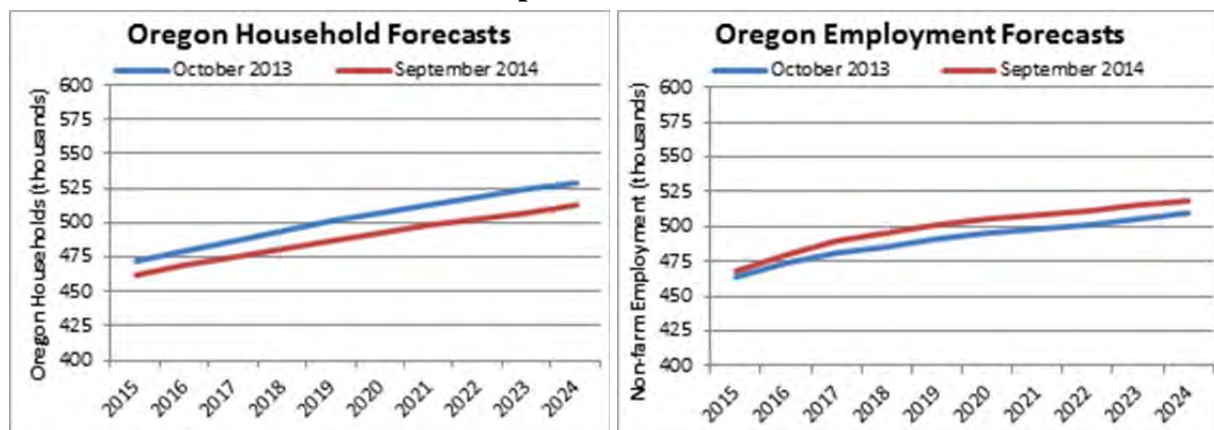

² Source: Oregon Public Utility Commission, 2013 Oregon Utility Statistics.

³ Source: Bureau of Labor Statistics.

Wyoming

The Company serves 15 of the 23 counties in Wyoming, with the largest metropolitan area served by the Company being Casper, Wyoming. Industrial sales make up approximately 74% of the Company’s Wyoming sales. Figure A.7 shows the change in household and employment forecasts for the 2013 IRP Update relative to the 2015 IRP forecast. This figure illustrates that both the forecast of households and employment forecast have increased slightly. Relative to the load forecast prepared for the 2013 IRP update, the Wyoming 2024 energy forecast decreased approximately 3.6 percent.

Figure A.7 – IHS Global Insight Wyoming Household and Employment forecasts from the October 2013 load forecast and the September 2014 load forecast

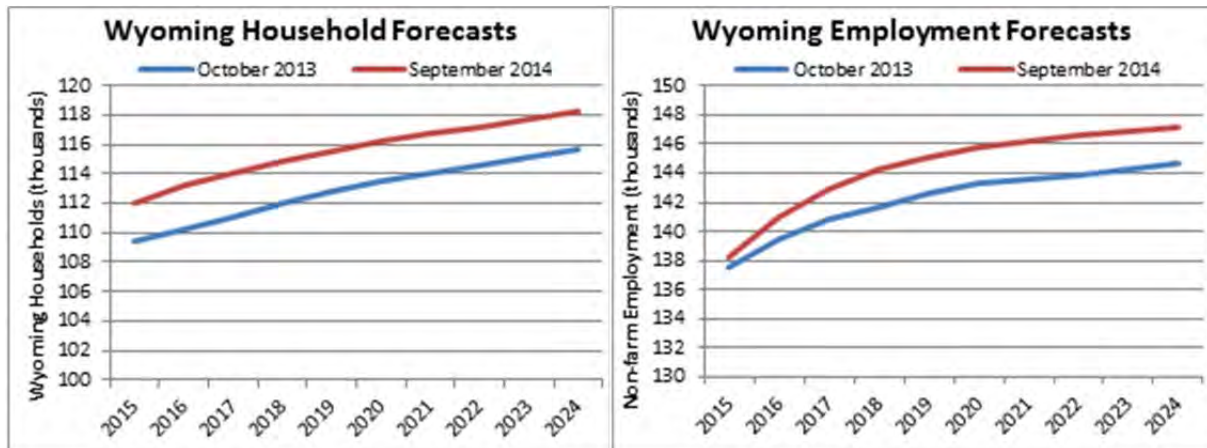

A risk to the Wyoming forecast is commodity prices, such as oil and natural gas, where volatility in prices and profitability can lead to swings in production and employment which translates to potential swings in the retail sales forecast.

Washington

PacifiCorp serves the following counties in Washington state: Benton, Columbia, Garfield, Klickitat, Walla Walla, and Yakima. Yakima is the most populated area that the Company serves in Washington State and has a large concentration of agriculture and food processing. Residential and commercial sales are roughly equal in size each making up approximately 38 percent of the Company’s Washington sales. Figure A.8 shows the change in household and employment forecasts for the 2013 IRP Update relative to the 2015 IRP forecast. This figure illustrates that both the forecast of households and employment forecast have decreased slightly. Relative to the load forecast prepared for the 2013 IRP update, the Washington 2024 energy forecast decreased approximately 0.8 percent.

Figure A.8 – IHS Global Insight Washington Household and Employment forecasts from the October 2013 load forecast and the September 2014 load forecast

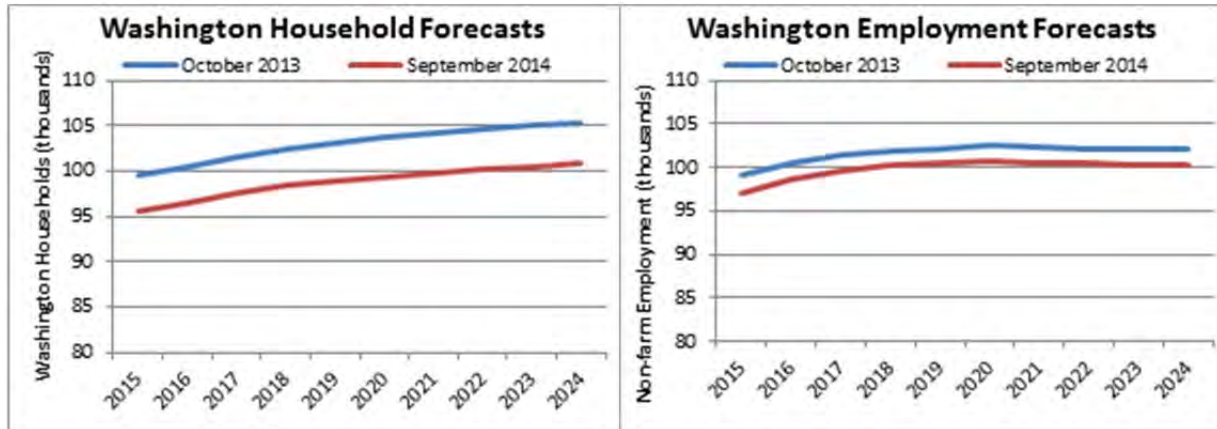

Idaho

The Company serves 14 of the 44 counties in the state of Idaho, with the majority of the Company’s service territory in rural Idaho. Idaho Falls and Pocatello are the largest cities in the area and are not served by PacifiCorp. Industrial sales make up approximately 50% of the Company’s Idaho sales. Figure A.9 shows the change in household and employment forecasts for the 2013 IRP Update relative to the 2015 IRP forecast. This figure illustrates that both the forecast of households and employment forecast have decreased slightly. Relative to the load forecast prepared for the 2013 IRP update, the Idaho 2024 energy forecast decreased approximately 0.4 percent.

Figure A.9 – IHS Global Insight Washington Household and Employment forecasts from the October 2013 load forecast and the September 2014 load forecast

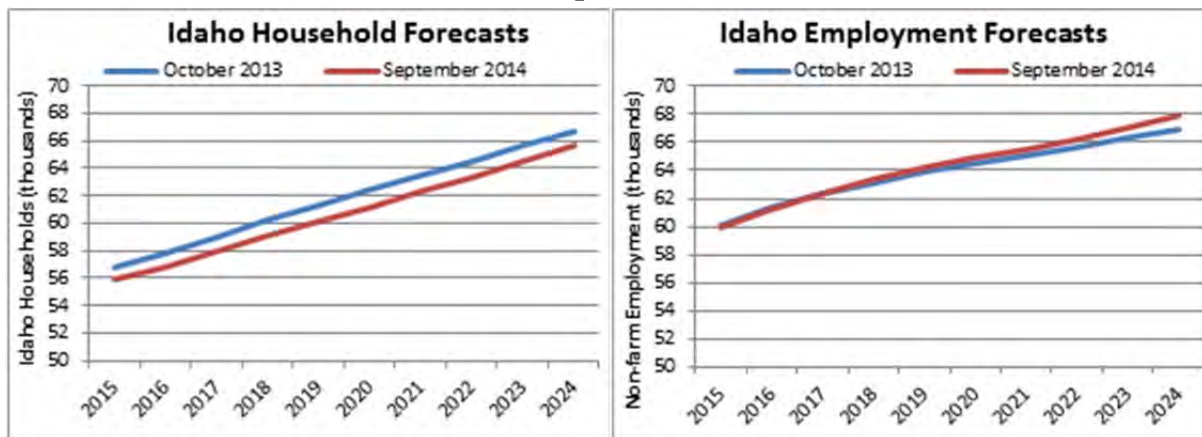

California

The four northern California counties served by PacifiCorp are largely rural: Del Norte, Modoc, Shasta and Siskiyou. Redding, the largest city in this area, is not served by PacifiCorp. Residential sales make up approximately 47 percent of the Company’s California sales. Figure A.10 shows the change in household and employment forecasts for the 2013 IRP Update relative to the 2015 IRP forecast. This figure illustrates that both the forecast of households and employment forecast have decreased slightly. Relative to the load forecast prepared for the 2013 IRP update, the California 2024 energy forecast decreased approximately 1.0 percent.

Figure A.10 – IHS Global Insight California Household and Employment forecasts from the October 2013 load forecast and the September 2014 load forecast

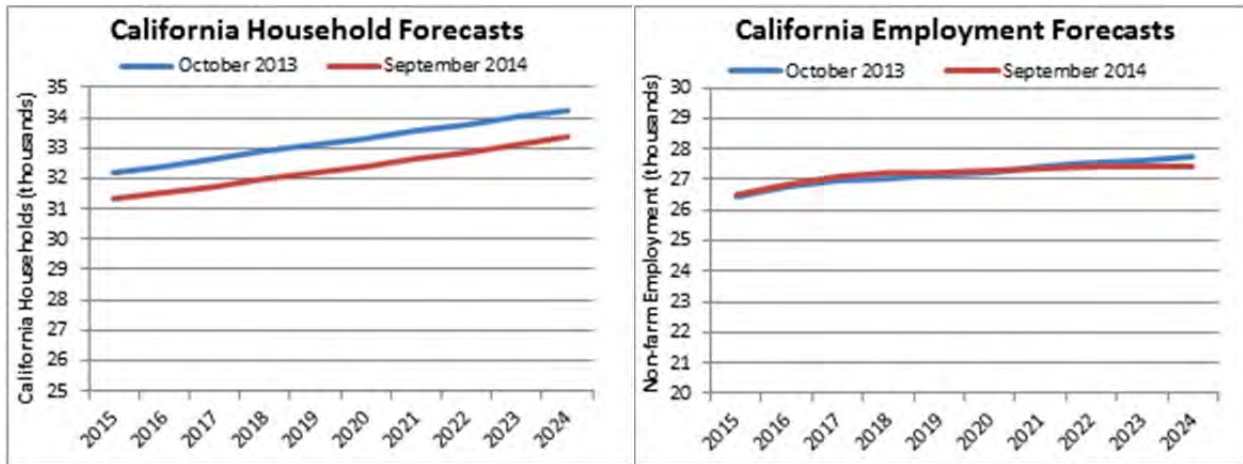

Weather

The Company’s load forecast is based on normal weather defined by the 20-year time period of 1994-2013. The Company updated its temperature spline models to the five-year time period of 2009-2013. The Company’s spline models are used to model the commercial and residential class temperature sensitivity at varying temperatures.

The Company has reviewed the appropriateness of using the average weather from a shorter time period as its “normal” peak weather. Figure A.11 indicates that peak producing weather does not change significantly when looking at a five, 10, or 20 year average.

Figure A.11 – Comparison of Utah 5, 10, and 20 Year Average Peak Producing Temperatures

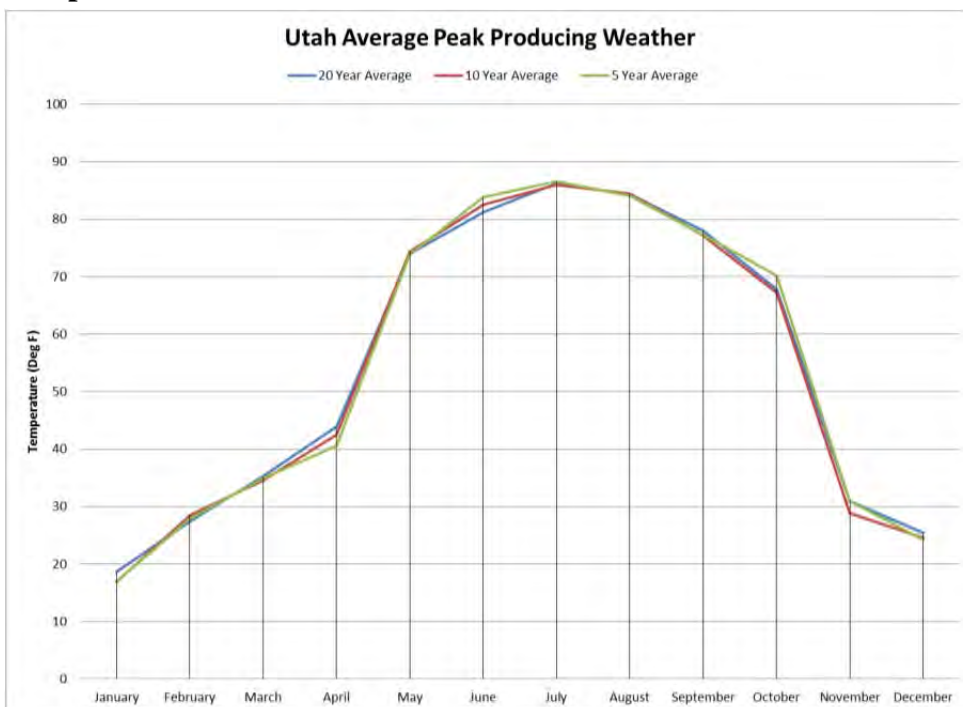

Statistically Adjusted End-Use (SAE)

The Company models sales per customer for the residential class using the SAE model, which combines the end-use modeling concepts with traditional regression analysis techniques. Major drivers of the SAE-based residential model are heating and cooling related variables, equipment shares, saturation levels and efficiency trends, and economic drivers such as household size, income and energy price. The Company uses ITRON for its load forecasting software and services, as well as SAE. To predict future changes in the efficiency of the various end uses for the residential class, an excel spreadsheet model obtained from ITRON was utilized; the model includes appliance efficiency trends based on appliance life as well as past and future efficiency standards. The model embeds all currently applicable laws and regulations regarding appliance efficiency, along with life cycle models of each appliance. The life cycle models, based on the decay and replacement rate are necessary to estimate how fast the existing stock of any given appliance turns over, i.e. newer more efficient equipment replacing older less efficient equipment. The underlying efficiency data is based on estimates of energy efficiency from the US Department of Energy's Energy Information Administration (EIA). The EIA estimates the efficiency of appliance stocks and the saturation of appliances at the national level and for individual Census Regions.

Individual Customer Forecast

The Company updated its load forecast for a select group of large industrial customers, self-generation facilities of large industrial customers, and data center forecasts within the respective jurisdictions. Customer forecasts are provided by the customer to the Company through a customer account manager (CAM).

Actual Load Data

With the exception of the industrial class, the Company uses actual load data from January 2000 through February 2014. The historical data period used to develop the industrial monthly sales is from January 2000 through February 2014 in Utah and Wyoming, January 2002 through February 2014 in Idaho, Oregon, and Washington, and January 2003 through February 2014 in California.

The following tables are the annual actual retail sales, non-coincident peak, and coincident peak by state used in calculating the 2015 IRP retail sales forecast.

Table A.5 – Weather Normalized Jurisdictional Retail Sales 2000 through 2014

System Retail Sales - Gigawatt-hours (GWh)*							
Year	California	Idaho	Oregon	Utah	Washington	Wyoming	System
2000	779	3,072	14,040	18,803	4,084	7,400	48,178
2001	778	2,956	13,505	18,478	4,020	7,684	47,421
2002	800	3,212	13,079	18,620	4,009	7,407	47,127
2003	819	3,242	13,033	19,248	4,050	7,475	47,868
2004	843	3,284	13,152	19,829	4,096	7,806	49,009
2005	836	3,245	13,326	20,214	4,205	8,042	49,868
2006	859	3,333	14,015	21,081	4,120	8,256	51,663
2007	877	3,364	14,067	21,973	4,068	8,492	52,840
2008	870	3,412	13,865	22,626	4,063	9,203	54,039
2009	832	2,949	13,173	22,082	4,025	9,262	52,323
2010	840	3,389	13,115	22,561	4,043	9,674	53,621
2011	806	3,432	12,994	23,343	4,011	9,764	54,350
2012	786	3,489	12,965	23,825	4,034	9,410	54,510
2013	776	3,546	12,989	23,834	4,047	9,561	54,754
2014	769	3,506	12,962	24,371	4,095	9,593	55,297
Average Annual Growth Rate							
2000-14	-0.09%	0.95%	-0.57%	1.87%	0.02%	1.87%	0.99%

*System retail sales do not include sales for resale

Table A.6 – Non-Coincident Jurisdictional Peak 2000 through 2014

Non-Coincident Peak - Megawatts (MW)*							
Year	California	Idaho	Oregon	Utah	Washington	Wyoming	System
2000	176	686	2,603	3,684	785	1,061	8,995
2001	162	616	2,739	3,480	755	1,124	8,876
2002	174	713	2,639	3,773	771	1,113	9,184
2003	169	722	2,451	4,004	788	1,126	9,260
2004	193	708	2,524	3,862	920	1,111	9,317
2005	189	753	2,721	4,081	844	1,224	9,811
2006	180	723	2,724	4,314	822	1,208	9,970
2007	187	789	2,856	4,571	834	1,230	10,466
2008	187	759	2,921	4,479	923	1,339	10,609
2009	193	688	3,121	4,404	917	1,383	10,705
2010	176	777	2,552	4,448	893	1,366	10,213
2011	177	770	2,686	4,596	854	1,404	10,486
2012	159	800	2,550	4,732	797	1,337	10,376
2013	182	814	2,980	5,091	886	1,398	11,351
2014	161	818	2,598	5,024	871	1,360	10,831
Average Annual Growth Rate							
2000-14	-0.64%	1.27%	-0.01%	2.24%	0.75%	1.78%	1.34%

*Non-coincident peaks do not include sales for resale

Table A.7 – Jurisdictional Contribution to Coincident Peak 2000 through 2014

Coincident Peak - Megawatts (MW)*							
Year	California	Idaho	Oregon	Utah	Washington	Wyoming	System
2000	154	523	2,347	3,684	756	979	8,443
2001	124	421	2,121	3,479	627	1,091	7,863
2002	162	689	2,138	3,721	758	1,043	8,511
2003	155	573	2,359	4,004	774	1,022	8,887
2004	120	603	2,200	3,831	740	1,094	8,588
2005	171	681	2,238	4,015	708	1,081	8,895
2006	156	561	2,684	3,972	816	1,094	9,283
2007	160	701	2,604	4,381	754	1,129	9,730
2008	171	682	2,521	4,145	728	1,208	9,456
2009	153	517	2,573	4,351	795	987	9,375
2010	144	527	2,442	4,294	757	1,208	9,373
2011	143	549	2,187	4,596	707	1,204	9,387
2012	156	782	2,163	4,731	749	1,225	9,806
2013	156	674	2,407	5,091	797	1,349	10,474
2014	150	630	2,345	5,024	819	1,294	10,263
Average Annual Growth Rate							
2000-14	-0.19%	1.34%	0.00%	2.24%	0.58%	2.01%	1.40%

*Coincident peaks do not include sales for resale

System Losses

System line losses were updated to reflect actual losses for the 5-year period ending December 31, 2013.

Forecast Methodology Overview

Class 2 Demand-side Management Resources in the Load Forecast

PacifiCorp modeled Class 2 DSM as a resource option to be selected as part of a cost-effective portfolio resource mix using the Company’s capacity expansion optimization model, System Optimizer. The load forecast used for IRP portfolio development excluded forecasted load reductions from Class 2 DSM; System Optimizer then determines the amount of Class 2 DSM—expressed as supply curves that relate incremental DSM quantities with their costs—given the other resource options and inputs included in the model. The use of Class 2 DSM supply curves, along with the economic screening provided by System Optimizer, determines the cost-effective mix of Class 2 DSM for a given scenario.

Modeling overview

The load forecast is developed by forecasting the monthly sales by customer class for each jurisdiction. The residential sales forecast is developed as a use-per-customer forecast multiplied by the forecast number of customers.

The customer forecasts are based on a combination of regression analysis and exponential smoothing techniques using historical data from January 2000 to February 2014. For the residential class, the Company forecasts the number of customers using IHS Global Insight’s forecast of each state’s number of households as the major driver.

The Company models sales per customer for the residential class using the SAE model discussed above, which combines the end-use modeling concepts with traditional regression analysis techniques.

For the commercial class, the Company forecasts sales using regression analysis techniques with non-manufacturing employment designated as the major economic driver, in addition to weather-related variables. Monthly sales for the commercial class are forecast directly from historical sales volumes, not as a product of the use per customer and number of customers. The development of the forecast of monthly commercial sales involves an additional step; to reflect the addition of a large “lumpy” change in sales such as a new data center, monthly commercial sales are increased based on input from the Company’s CAM’s. Although the scale is much smaller, the treatment of large commercial additions is similar to the methodology for large industrial customer sales, which is discussed below.

Monthly sales for irrigation and street lighting are forecast directly from historical sales volumes, not as a product of the use per customer and number of customers.

The majority of industrial sales are modeled using regression analysis with trend and economic variables. Manufacturing employment is used as the major economic driver. For a small number of the very largest industrial customers, the Company prepares individual forecasts based on input from the customer and information provided by the CAM’s.

After the Company develops the forecasts of monthly energy sales by customer class, a forecast of hourly loads is developed in two steps. First, monthly peak forecasts are developed for each state. The monthly peak model uses historical peak-producing weather for each state, and incorporates the impact of weather on peak loads through several weather variables that drive heating and cooling usage. The weather variables include the average temperature on the peak day and lagged average temperatures from up to two days before the day of the forecast. The peak forecast is based on average monthly historical peak-producing weather for the 20-year period, 1994 through 2013. Second, the Company develops hourly load forecasts for each state using hourly load models that include state-specific hourly load data, daily weather variables, the 20-year average temperatures as identified above, a typical annual weather pattern, and day-type variables such as weekends and holidays as inputs to the model. The hourly loads are adjusted to match the monthly peaks from the first step above. Hourly loads are then adjusted so the monthly sum of hourly loads equals monthly sales plus line losses.

After the hourly load forecasts are developed for each state, hourly loads are aggregated to the total system level. The system coincident peaks can then be identified, as well as the contribution of each jurisdiction to those monthly peaks.

Sales Forecast at the Customer Meter

This section provides total system and state-level forecasted retail sales summaries measured at the customer meter by customer class including load reduction projections from new energy efficiency measures from the Preferred Portfolio.

Table A.8 – System Annual Sales Forecast 2015 through 2024

System Retail Sales – Gigawatt-hours (GWh)							
Year	Residential	Commercial	Industrial	Irrigation	Lighting	Public Authority	Total
2015	15,624,212	17,342,946	20,720,928	1,389,301	143,460	274,200	55,495,047
2016	15,671,354	17,579,292	21,041,923	1,388,035	144,040	274,940	56,099,585
2017	15,626,345	17,727,257	21,082,095	1,386,409	143,650	274,200	56,239,956
2018	15,630,039	17,820,123	21,115,922	1,384,596	143,700	274,200	56,368,580
2019	15,651,098	17,843,052	21,154,829	1,382,404	143,710	274,200	56,449,292
2020	15,575,099	17,929,515	21,319,441	1,381,044	144,130	274,940	56,624,168
2021	15,479,683	17,894,201	21,288,648	1,379,452	143,720	274,200	56,459,905
2022	15,443,463	17,901,109	21,366,407	1,377,766	143,720	274,200	56,506,666
2023	15,355,476	17,915,244	21,391,383	1,375,943	143,720	274,200	56,455,966
2024	15,333,417	17,966,054	21,525,322	1,374,111	144,140	274,940	56,617,985
Average Annual Growth Rate							
2015-24	-0.2%	0.4%	0.4%	-0.1%	0.1%	0.0%	0.2%

Residential

Average annual growth of the residential class sales forecast declined from 0.6 percent in the 2013 IRP Update to -0.2 percent in the 2015 IRP.

The number of residential customers across PacifiCorp’s system is expected to grow at an annual average rate of 1.0 percent, reaching approximately 1.7 million customers in 2024, with Rocky Mountain Power states adding 1.4 percent per year and Pacific Power states adding 0.4 percent per year. New customers on PacifiCorp’s system will also contribute to declining average use of the residential class. It is expected that new single-family homes are likely to use more efficient appliances and use gas instead of electricity for both space and water heating.

Commercial

Average annual growth of the commercial class sales forecast declined from 1.1 percent annual average growth in the 2013 IRP Update to 0.4 percent expected average annual growth. The Company lowered its data center load expectations in Utah and Oregon in the 2015 IRP load forecast due to lower than expected initial loads and additional energy efficiency gains in the technology industry.

PacifiCorp total commercial customers are expected to grow at an annual average rate of 0.8 percent, reaching almost 219,000 total customers in 2024. Rocky Mountain Power is expected to add commercial customers at 1.4 percent annually, and Pacific Power is forecasted to add 0.4 percent annually.

Industrial

Average annual growth of the industrial class sales forecast declined from 1.7 percent annual average growth in the 2013 IRP Update to 0.4 percent expected annual growth.

A portion of the Company’s industrial load is in the oil and natural gas sector in Utah and Wyoming; therefore, changes in natural gas and oil prices can impact the Company’s load forecast. The Company has seen several large industrial customers cancel expected new load when gas and oil prices have fallen. The risk to the Company’s load forecast due to commodity price changes is reflected in the high and low economic growth scenarios discussed below.

State Summaries

Oregon

Table A.9 summarizes Oregon state forecasted retail sales growth by customer class.

Table A.9 – Forecasted Sales Growth in Oregon

Oregon Retail Sales – Gigawatt-hours (GWh)						
Year	Residential	Commercial	Industrial	Irrigation	Lighting	Total
2015	5,360,653	5,154,353	2,210,849	336,200	38,120	13,100,175
2016	5,368,670	5,173,475	2,152,886	336,220	38,230	13,069,482
2017	5,350,386	5,177,190	2,150,466	336,200	38,120	13,052,362
2018	5,353,337	5,169,956	2,146,991	336,200	38,120	13,044,604
2019	5,359,816	5,168,774	2,158,608	336,200	38,120	13,061,519
2020	5,332,311	5,182,723	2,174,162	336,220	38,230	13,063,647
2021	5,298,646	5,167,021	2,170,389	336,200	38,120	13,010,376
2022	5,302,350	5,168,914	2,179,082	336,200	38,120	13,024,666
2023	5,316,727	5,178,033	2,201,761	336,200	38,120	13,070,841
2024	5,351,686	5,197,730	2,221,090	336,220	38,230	13,144,955
Average Annual Growth Rate						
2015-24	-0.02%	0.09%	0.05%	0.00%	0.03%	0.04%

Washington

Table A.10 summarizes Washington state forecasted retail sales growth by customer class.

Table A.10 – Forecasted Sales Growth in Washington

Washington Retail Sales – Gigawatt-hours (GWh)						
Year	Residential	Commercial	Industrial	Irrigation	Lighting	Total
2015	1,569,627	1,493,393	799,153	146,360	9,880	4,018,413
2016	1,565,767	1,511,324	799,998	146,360	9,920	4,033,370
2017	1,550,682	1,516,347	795,591	146,360	9,880	4,018,861
2018	1,541,720	1,519,230	793,175	146,360	9,880	4,010,365
2019	1,532,980	1,516,819	789,882	146,360	9,880	3,995,921
2020	1,521,339	1,520,946	790,678	146,360	9,910	3,989,234
2021	1,504,294	1,510,434	786,721	146,360	9,880	3,957,689
2022	1,495,254	1,503,091	784,623	146,360	9,880	3,939,208
2023	1,487,377	1,494,554	782,226	146,360	9,880	3,920,397
2024	1,485,476	1,490,312	782,385	146,360	9,910	3,914,444
Average Annual Growth Rate						
2015-24	-0.61%	-0.02%	-0.24%	0.00%	0.03%	-0.29%

California

Table A.11 summarizes California state forecasted sales growth by customer class.

Table A.11 – Forecasted Retail Sales Growth in California

California Retail Sales – Gigawatt-hours (GWh)						
Year	Residential	Commercial	Industrial	Irrigation	Lighting	Total
2015	367,336	245,057	48,405	97,200	2,440	760,438
2016	363,742	247,502	47,931	97,210	2,450	758,834
2017	357,816	247,990	47,065	97,200	2,440	752,510
2018	352,992	247,459	46,246	97,200	2,440	746,338
2019	347,391	245,401	45,669	97,200	2,440	738,100
2020	341,676	244,571	45,479	97,210	2,450	731,387
2021	335,190	241,147	44,996	97,200	2,440	720,974
2022	330,807	238,115	44,644	97,200	2,440	713,207
2023	324,464	234,168	44,250	97,200	2,440	702,522
2024	318,273	229,737	44,007	97,210	2,450	691,677
Average Annual Growth Rate						
2015-24	-1.58%	-0.71%	-1.05%	0.00%	0.05%	-1.05%

Utah

Table A.12 summarizes Utah state forecasted sales growth by customer class.

Table A.12 – Forecasted Retail Sales Growth in Utah

Utah Retail Sales – Gigawatt-hours (GWh)							
Year	Residential	Commercial	Industrial	Irrigation	Lighting	Public Authority	Total
2015	6,573,550	8,458,275	8,706,305	197,050	78,630	274,200	24,288,010
2016	6,612,206	8,640,260	8,879,349	197,070	79,000	274,940	24,682,825
2017	6,613,877	8,771,098	8,863,813	197,050	78,820	274,200	24,798,858
2018	6,632,592	8,859,585	8,825,036	197,050	78,870	274,200	24,867,333
2019	6,660,939	8,882,841	8,871,333	197,050	78,880	274,200	24,965,243
2020	6,638,380	8,941,286	8,945,399	197,070	79,100	274,940	25,076,174
2021	6,613,722	8,938,827	8,968,815	197,050	78,890	274,200	25,071,504
2022	6,593,527	8,953,660	9,010,338	197,050	78,890	274,200	25,107,665
2023	6,511,571	8,970,081	9,054,936	197,050	78,890	274,200	25,086,727
2024	6,462,703	9,003,525	9,125,505	197,070	79,110	274,940	25,142,854
Average Annual Growth Rate							
2015-24	-0.19%	0.70%	0.52%	0.00%	0.07%	0.03%	0.39%

Idaho

Table A.13 summarizes Idaho state forecasted sales growth by customer class.

Table A.13 – Forecasted Retail Sales Growth in Idaho

Idaho Retail Sales – Gigawatt-hours (GWh)						
Year	Residential	Commercial	Industrial	Irrigation	Lighting	Total
2015	691,046	431,993	1,735,730	587,611	2,620	3,449,001
2016	694,712	434,035	1,739,113	586,295	2,630	3,456,785
2017	693,151	439,322	1,739,284	584,719	2,620	3,459,097
2018	693,955	445,150	1,739,788	582,906	2,620	3,464,420
2019	699,839	451,275	1,735,331	580,714	2,620	3,469,779
2020	702,725	458,506	1,734,443	579,304	2,630	3,477,608
2021	704,164	462,363	1,731,347	577,762	2,620	3,478,257
2022	709,279	467,475	1,728,793	576,076	2,620	3,484,243
2023	714,575	472,812	1,726,178	574,253	2,620	3,490,438
2024	722,386	478,436	1,724,423	572,371	2,630	3,500,246
Average Annual Growth Rate						
2015-24	0.49%	1.14%	-0.07%	-0.29%	0.04%	0.16%

Wyoming

Table A.14 summarizes Wyoming state forecasted sales growth by customer class.

Table A.14 – Forecasted Retail Sales Growth in Wyoming

Wyoming Retail Sales – Gigawatt-hours (GWh)						
Year	Residential	Commercial	Industrial	Irrigation	Lighting	Total
2015	1,061,999	1,559,876	7,220,486	24,880	11,770	9,879,011
2016	1,066,258	1,572,694	7,422,646	24,880	11,810	10,098,288
2017	1,060,434	1,575,309	7,485,875	24,880	11,770	10,158,268
2018	1,055,442	1,578,744	7,564,685	24,880	11,770	10,235,521
2019	1,050,132	1,577,942	7,554,005	24,880	11,770	10,218,729
2020	1,038,667	1,581,482	7,629,280	24,880	11,810	10,286,119
2021	1,023,668	1,574,408	7,586,380	24,880	11,770	10,221,106
2022	1,012,246	1,569,855	7,618,926	24,880	11,770	10,237,676
2023	1,000,763	1,565,596	7,582,031	24,880	11,770	10,185,041
2024	992,892	1,566,315	7,627,912	24,880	11,810	10,223,809
Average Annual Growth Rate						
2015-24	-0.74%	0.05%	0.61%	0.00%	0.04%	0.38%

Alternative Load Forecast Scenarios

The purpose of providing alternative load forecast cases is to determine the resource type and timing impacts resulting from a change in the economy or system peaks as a result of higher than normal temperatures.

The September 2014 forecast is the baseline scenario. For the high and low economic growth scenarios assumptions from IHS Global Insight were applied to the economic drivers in the Company's load forecasting models. These growth assumptions were extended for the entire forecast horizon.

Recognizing the volatility associated with the oil and gas extraction industries, PacifiCorp applied additional assumptions for the Utah and Wyoming industrial class load forecasts in the high and low scenario. Specifically, the Company focused on the increased uncertainty of the industrial load forecast as it moves further out in time. In order to capture this increased uncertainty the Company modeled 1,000 possible annual loads for each year based on the standard error of the medium scenario regression equation. The 1,000 load values are then ranked and the Company selected the 95th percentile and 5th percentile of the Utah and Wyoming industrial loads for both the low and high growth scenarios.

For the 1-in-20 year (5 percent probability) extreme weather scenario, the Company used 1-in-20 year peak weather for summer (July) months for each state. The 1-in-20 year peak weather is defined as the year for which the peak has the chance of occurring once in 20 years.

Figure A.12 shows the comparison of the above scenarios relative to the Base Case scenario.

Figure A.12 – Load Forecast Scenarios for 1-in-20 Weather, High, Base Case and Low

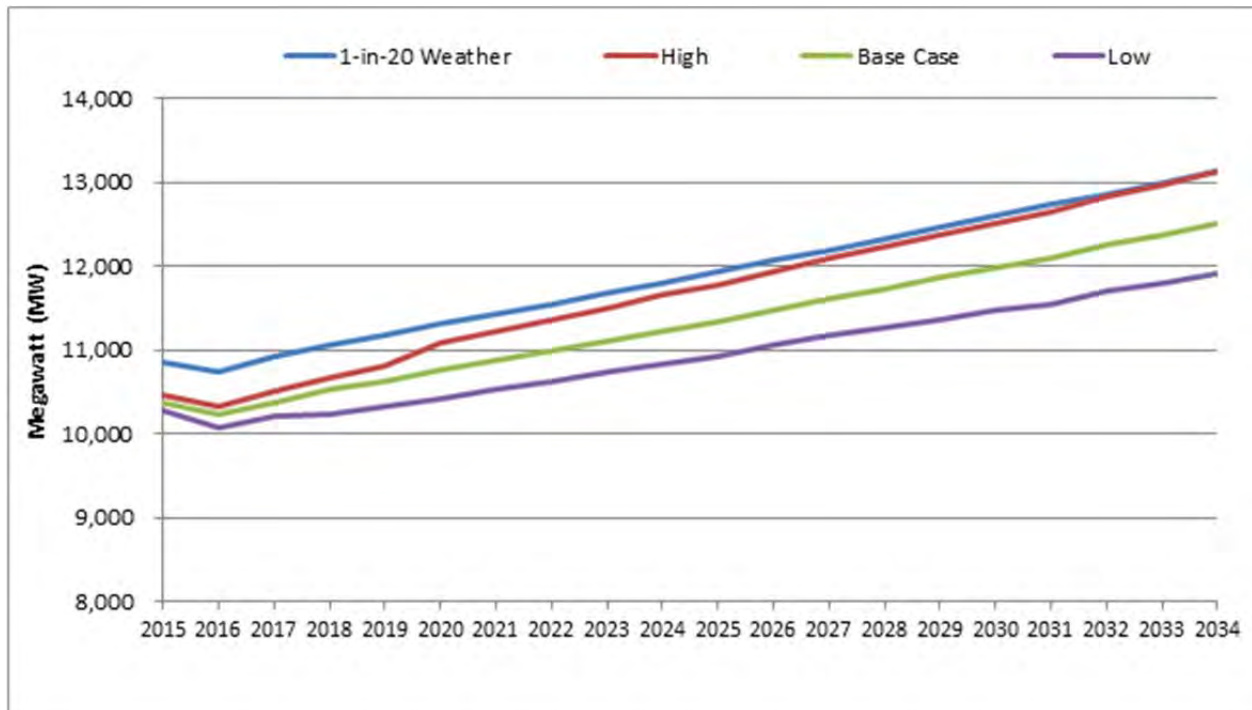

APPENDIX B – IRP REGULATORY COMPLIANCE

Introduction

This appendix describes how PacifiCorp's 2015 IRP complies with (1) the various state commission IRP standards and guidelines, (2) specific analytical requirements stemming from acknowledgment orders for the Company's last IRP (2013 IRP), and (3) state commission IRP requirements stemming from other regulatory proceedings.

Included in this appendix are the following tables:

- Table B.1 – Provides an overview and comparison of the rules in each state for which IRP submission is required.⁴
- Table B.2 – Provides a description of how PacifiCorp addressed the 2013 IRP acknowledgement requirements and other commission directives.
- Table B.3 – Provides an explanation of how this plan addresses each of the items contained in the Oregon IRP guidelines.
- Table B.4 – Provides an explanation of how this plan addresses each of the items contained in the Public Service Commission of Utah IRP Standard and Guidelines issued in June 1992.
- Table B.5 – Provides an explanation of how this plan addresses each of the items contained in the Washington Utilities and Trade Commission IRP guidelines issued in January 2006.
- Table B.6 – Provides an explanation of how this plan addresses each of the items contained in the Wyoming Public Service Commission IRP guidelines.

General Compliance

PacifiCorp prepares the IRP on a biennial basis and files the IRP with state commissions. The preparation of the IRP is done in an open public process with consultation between all interested parties, including commissioners and commission staff, customers, and other stakeholders. This open process provides parties with a substantial opportunity to contribute information and ideas in the planning process, and also serves to inform all parties on the planning issues and approach. The public input process for this IRP, described in Volume I, Chapter 2 (Introduction), as well as Volume II, Appendix C (Public Input Process) fully complies with IRP Standards and Guidelines.

The IRP provides a framework and plan for future actions to ensure PacifiCorp continues to provide reliable and least-cost electric service to its customers. The IRP evaluates, over a twenty-year planning period, the future loads of PacifiCorp customers and the resources required to meet this load.

To fill any gap between changes in loads and existing resources, while taking into consideration potential early retirement of existing coal units as an alternative to investments that achieve compliance with environmental regulations, the IRP evaluates a broad range of available resource options, as required by state commission rules. These resource alternatives include

⁴ California guidelines exempt a utility with less than 500,000 customers in the state from filing an IRP. However, PacifiCorp files its IRP and IRP supplements with the California Public Utilities Commission to address the Company plan for compliance with the California RPS requirements.

supply-side, demand-side, market, and transmission alternatives. The evaluation of the alternatives in the IRP, as detailed in Volume I, Chapters 7 (Modeling and Portfolio Evaluation Approach) and Chapter 8 (Modeling and Portfolio Selection Results) meets this requirement and includes the impact to system costs, system operations, supply and transmission reliability, and the impacts of various risks, uncertainties and externality costs that may occur. To perform the analysis and evaluation, PacifiCorp employs a suite of models that simulate the complex operation of the PacifiCorp system and its integration within the Western Interconnection. The models allow for a rigorous testing of a reasonably broad range of commercially feasible resource alternatives available to PacifiCorp on a consistent and comparable basis. The analytical process, including the risk and uncertainty analysis, fully complies with IRP Standards and Guidelines, and is described in detail in Volume I, Chapter 7 (Modeling and Portfolio Evaluation Approach).

The IRP analysis is designed to define a resource plan that is least cost, after consideration of risks and uncertainties. To test resource alternatives and identify a least-cost, risk-adjusted plan, portfolio resource options were developed and tested against each other. This testing included examination of various tradeoffs among the portfolios, such as average cost versus risk, reliability, customer rate impacts, and average annual CO₂ emissions. This portfolio analysis and the results and conclusions drawn from the analysis are described in Volume I, Chapter 8 (Modeling and Portfolio Selection Results).

Consistent with the IRP Standards and Guidelines of Oregon, Utah, and Washington, this IRP includes an action plan in Volume I, Chapter 9 (Action Plan and Resource Procurement). The action plan details near-term actions that are necessary to ensure PacifiCorp continues to provide reliable and least-cost electric service after considering risk and uncertainty. Volume I, Chapter 9 also provides a progress report on action items contained in the 2013 IRP.

The 2015 IRP and related action plan are filed with each commission with a request for prompt acknowledgment. Acknowledgment means that a commission recognizes the IRP as meeting all regulatory requirements at the time of acknowledgment. In the case where a commission acknowledges the IRP in part or not at all, PacifiCorp works with the commission to modify and re-file an IRP that meets their acknowledgment standards.

State commission acknowledgment orders or letters typically stress that an acknowledgment does not indicate approval or endorsement of IRP conclusions or analysis results. Similarly, an acknowledgment does not imply that favorable ratemaking treatment for resources proposed in the IRP will be given.

California

Subsection (i) of California Public Utilities Code, Section 454.5, states that utilities serving less than 500,000 customers in the state are exempt from filing an IRP for California. The number of PacifiCorp customers, located in the most northern parts of the state, fall below this threshold. PacifiCorp filed for and received an exemption on July 10, 2003.

Idaho

The Idaho Public Utilities Commission's Order No. 22299, issued in January 1989, specifies integrated resource planning requirements. The Order mandates that PacifiCorp submit a

Resource Management Report (RMR) on a biennial basis. The intent of the RMR is to describe the status of IRP efforts in a concise format, and cover the following areas:

Each utility's RMR should discuss any flexibilities and analyses considered during comprehensive resource planning, such as: (1) examination of load forecast uncertainties; (2) effects of known or potential changes to existing resources; (3) consideration of demand and supply side resource options; and (4) contingencies for upgrading, optioning and acquiring resources at optimum times (considering cost, availability, lead time, reliability, risk, etc.) as future events unfold.

This IRP is submitted to the Idaho PUC as the Resource Management Report for 2015, and fully addresses the above report components.

Oregon

This IRP is submitted to the Oregon Public Utility Commission (OPUC) in compliance with its planning guidelines issued in January 2007 (Order No. 07-002). The Commission's IRP guidelines consist of substantive requirements (Guideline 1), procedural requirements (Guideline 2), plan filing, review, and updates (Guideline 3), plan components (Guideline 4), transmission (Guideline 5), conservation (Guideline 6), demand response (Guideline 7), environmental costs (Guideline 8, Order No. 08-339, dated June 30, 2008), direct access loads (Guideline 9), multi-state utilities (Guideline 10), reliability (Guideline 11), distributed generation (Guideline 12), resource acquisition (Guideline 13), and flexible resource capacity (Order No. 12-013⁵).

Consistent with the earlier guidelines (Order 89-507, dated April 20, 1989), the Commission notes that acknowledgment does not guarantee favorable ratemaking treatment, only that the plan seems reasonable at the time acknowledgment is given. Table B.3 provides detail on how this plan addresses each of the requirements.

Utah

This IRP is submitted to the State of Utah Public Service Commission (PSC) in compliance with its 1992 Order on Standards and Guidelines for Integrated Resource Planning (Docket No. 90-2035-01, "Report and Order on Standards and Guidelines"). Table B.4 documents how PacifiCorp complies with each of these standards.

Washington

This IRP is submitted to the Washington Utilities and Transportation Commission (WUTC) in compliance with its rule requiring least cost planning (Washington Administrative Code 480-100-238), and the rule amendment issued on January 9, 2006 (WAC 480-100-238, Docket No. UE-030311). In addition to a least cost plan, the rule requires provision of a two-year action plan and a progress report that "relates the new plan to the previously filed plan."

The rule requires PacifiCorp to submit a work plan for informal commission review not later than 12 months prior to the due date of the plan. The work plan is to lay out the contents of the IRP, the resource assessment method, and timing and extent of public participation. PacifiCorp

⁵ Public Utility Commission of Oregon, Order No. 12-013, Docket No. 1461, January 19, 2012.

filed a work plan with the Commission on March 31, 2014 in Docket No. UE-140546. Table B.5 provides detail on how this plan addresses each of the rule requirements.

Wyoming

Wyoming Public Service Commission (WPSC) Rule 253 provides guidance on filing IRPs for any utility serving Wyoming customers. The rule, shown below, went into effect in September 2009. Table B.6 provides detail on how this plan addresses the rule requirements.

Rule 253: Integrated Resource Planning.

Any utility serving in Wyoming required to file an integrated resource plan (IRP) in any jurisdiction, shall file that IRP with the Wyoming Public Service Commission. The Commission may require any utility serving in Wyoming to prepare and file an IRP when the Commission determines it is in the public interest. Commission advisory staff shall review the IRP as directed by the Commission and report its findings to the Commission in open meeting. The review may be conducted in accordance with guidelines set from time to time as conditions warrant.

Table B.1 – Integrated Resource Planning Standards and Guidelines Summary by State

Topic	Oregon	Utah	Washington	Idaho	Wyoming
Source	<p>Order No. 07-002, <i>Investigation Into Integrated Resource Planning</i>, January 8, 2007, as amended by Order No. 07-047.</p> <p>Order No. 08-339, <i>Investigation into the Treatment of CO2 Risk in the Integrated Resource Planning Process</i>, June 30, 2008.</p> <p>Order No. 09-041, New Rule OAR 860-027-0400, implementing Guideline 3, “Plan Filing, Review, and Updates”.</p> <p>Order No. 12-013, “Investigation of Matters related to Electric Vehicle Charging”, January 19, 2012.</p>	<p>Docket 90-2035-01 <i>Standards and Guidelines for Integrated Resource Planning</i> June 18, 1992.</p>	<p>WAC 480-100-251 Least cost planning, May 19, 1987, and as amended from WAC 480-100-238 <i>Least Cost Planning Rulemaking</i>, January 9, 2006 (Docket # UE-030311)</p>	<p>Order 22299 <i>Electric Utility Conservation Standards and Practices</i> January, 1989.</p>	<p>See Wyoming section above for Wyoming Commission Rule 253.</p>
Filing Requirements	<p>Least-cost plans must be filed with the Commission.</p>	<p>An Integrated Resource Plan (IRP) is to be submitted to Commission.</p>	<p>Submit a least cost plan to the Commission. Plan to be developed with consultation of Commission staff, and with public involvement.</p>	<p>Submit “Resource Management Report” (RMR) on planning status. Also file progress reports on conservation, low-income programs, lost opportunities and capability building.</p>	<p>Any utility serving in Wyoming required to file an integrated resource plan (IRP) in any jurisdiction, shall file that IRP with the Wyoming Public Service Commission.</p>

Topic	Oregon	Utah	Washington	Idaho	Wyoming
Frequency	Plans filed biennially, within two years of its previous IRP acknowledgment order. An annual update to the most recently acknowledged IRP is required to be filed on or before the one-year anniversary of the acknowledgment order date. While informational only, utilities may request acknowledgment of proposed changes to the action plan.	File biennially.	File biennially.	RMR to be filed at least biennially. Conservation reports to be filed annually. Low income reports to be filed at least annually. Lost Opportunities reports to be filed at least annually. Capability building reports to be filed at least annually.	The Commission may require any utility serving in Wyoming to prepare and file an IRP when the Commission determines it is in the public interest.
Commission Response	Least-cost plan (LCP) <i>acknowledged</i> if found to comply with standards and guidelines. A decision made in the LCP process does not guarantee favorable rate-making treatment. The OPUC may direct the utility to revise the IRP or conduct additional analysis before an acknowledgment order is issued. Note, however, that Rate Plan legislation allows pre-approval of near-term resource investments.	IRP acknowledged if found to comply with standards and guidelines. Prudence reviews of new resource acquisitions will occur during rate making proceedings.	The plan will be considered, with other available information, when evaluating the performance of the utility in rate proceedings. WUTC sends a letter discussing the report, making suggestions and requirements and acknowledges the report.	Report does not constitute pre-approval of proposed resource acquisitions. Idaho sends a short letter stating that they accept the filing and acknowledge the report as satisfying Commission requirements.	Commission advisory staff shall review the IRP as directed by the Commission and report its findings to the Commission in open meeting.

Topic	Oregon	Utah	Washington	Idaho	Wyoming
Process	<p>The public and other utilities are allowed significant involvement in the preparation of the plan, with opportunities to contribute and receive information. Order 07-002 requires that the utility present IRP results to the OPUC at a public meeting prior to the deadline for written public comments. Commission staff and parties should complete their comments and recommendations within six months after IRP filing. Competitive secrets must be protected.</p>	<p>Planning process open to the public at all stages. IRP developed in consultation with the Commission, its staff, with ample opportunity for public input.</p>	<p>In consultation with Commission staff, develop and implement a public involvement plan. Involvement by the public in development of the plan is required. PacifiCorp is required to submit a work plan for informal commission review not later than 12 months prior to the due date of the plan. The work plan is to lay out the contents of the IRP, resource assessment method, and timing and extent of public participation.</p>	<p>Utilities to work with Commission staff when reviewing and updating RMRs. Regular public workshops should be part of process.</p>	<p>The review may be conducted in accordance with guidelines set from time to time as conditions warrant.</p> <p>The Public Service Commission of Wyoming, in its Letter Order on PacifiCorp’s 2008 IRP (Docket No. 2000-346-EA-09) adopted Commission Staff’s recommendation to expand the review process to include a technical conference, an expanded public comment period, and filing of reply comments.</p>
Focus	<p>20-year plan, with end-effects, and a short-term (two-year) action plan. The IRP process should result in the selection of that mix of options which yields, for society over the long run, the best combination of expected costs and variance of costs.</p>	<p>20-year plan, with short-term (four-year) action plan. Specific actions for the first two years and anticipated actions in the second two years to be detailed. The IRP process should result in the selection of the optimal set of resources given the expected combination of costs, risk and uncertainty.</p>	<p>20-year plan, with short-term (two-year) action plan. The plan describes mix of resources sufficient to meet current and future loads at “lowest reasonable” cost to utility and ratepayers. Resource cost, market volatility risks, demand-side resource uncertainty, resource dispatchability, ratepayer risks, policy impacts, and environmental risks, must be considered.</p>	<p>20-year plan to meet load obligations at least-cost, with equal consideration to demand side resources. Plan to address risks and uncertainties. Emphasis on clarity, understandability, resource capabilities and planning flexibility.</p>	<p>Identification of least-cost/least-risk resources and discussion of deviations from least-cost resources or resource combinations.</p>

Topic	Oregon	Utah	Washington	Idaho	Wyoming
<p>Elements</p>	<p>Basic elements include:</p> <ul style="list-style-type: none"> • All resources evaluated on a consistent and comparable basis. • Risk and uncertainty must be considered. • The primary goal must be least cost, consistent with the long-run public interest. • The plan must be consistent with Oregon and federal energy policy. • External costs must be considered, and quantified where possible. OPUC specifies environmental adders (Order No. 93-695, Docket UM 424). • Multi-state utilities should plan their generation and transmission systems on an integrated-system basis. • Construction of resource portfolios over the range of identified risks and uncertainties. • Portfolio analysis shall include fuel transportation and transmission requirements. • Plan includes 	<p>IRP will include:</p> <ul style="list-style-type: none"> • Range of forecasts of future load growth • Evaluation of all present and future resources, including demand side, supply side and market, on a consistent and comparable basis. • Analysis of the role of competitive bidding • A plan for adapting to different paths as the future unfolds. • A cost effectiveness methodology. • An evaluation of the financial, competitive, reliability and operational risks associated with resource options, and how the action plan addresses these risks. • Definition of how risks are allocated between ratepayers and shareholders 	<p>The plan shall include:</p> <ul style="list-style-type: none"> • A range of forecasts of future demand using methods that examine the effect of economic forces on the consumption of electricity and that address changes in the number, type and efficiency of electrical end-uses. • An assessment of commercially available conservation, including load management, as well as an assessment of currently employed and new policies and programs needed to obtain the conservation improvements. • Assessment of a wide range of conventional and commercially available nonconventional generating technologies • An assessment of transmission system capability and reliability. • A comparative evaluation of energy supply resources (including transmission and 	<p>Discuss analyses considered including:</p> <ul style="list-style-type: none"> • Load forecast uncertainties; • Known or potential changes to existing resources; • Equal consideration of demand and supply side resource options; • Contingencies for upgrading, optioning and acquiring resources at optimum times; • Report on existing resource stack, load forecast and additional resource menu. 	<p>Proposed Commission Staff guidelines issued on January 2009 cover:</p> <ul style="list-style-type: none"> • Sufficiency of the public comment process • Utility strategic goals and preferred portfolio • Resource need and changes in expected resource acquisitions • Environmental impacts • Market purchase evaluation • Reserve margin analysis • Demand-side management and energy efficiency

Topic	Oregon	Utah	Washington	Idaho	Wyoming
	<p>conservation potential study, demand response resources, environmental costs, and distributed generation technologies.</p> <ul style="list-style-type: none"> • Avoided cost filing required within 30 days of acknowledgment. 		<p>distribution) and improvements in conservation using “lowest reasonable cost” criteria.</p> <ul style="list-style-type: none"> • Integration of the demand forecasts and resource evaluations into a long-range (at least 10 years) plan. • All plans shall also include a progress report that relates the new plan to the previously filed plan. 		

Table B.2 – Handling of 2015 IRP Acknowledgment and Other IRP Requirements

Reference	IRP Requirement or Recommendation	How the Requirement or Recommendation is Addressed in the 2015 IRP
Idaho		
Order No. PAC-E-13-05, p. 12.	The Commission directs the Company to increase its efforts toward achieving higher levels of cost-effective DSM. In future IRP and DSM filings, the Commission directs the Company to present clear and quantifiable metrics governing its actions regarding decisions to implement or decline to implement energy efficiency programs.	PacifiCorp has targeted all cost-effective DSM as selected by System Optimizer in the 2015 IRP and provides an update on its DSM acquisition action items from the 2013 IRP in Volume I, Chapter 9. DSM selections and the associated action plan from the 2015 IRP are presented in Volume I, Chapter 8 and Volume I, Chapter 9. PacifiCorp’s 2015 IRP DSM state implementation plans are provided in Appendix D.
Oregon		
Order No. 14-252, p. 3	Beginning in the third quarter of 2014, PacifiCorp will appear before the Commission to provide quarterly updates on coal plant compliance requirements, legal proceedings, pollution control investments, and other major capital expenditures on its coal plants or transmission projects. PacifiCorp may provide a written report and need not appear if there are no significant changes between the quarterly updates.	OPUC Order No. 14-288 modified the requirements, moving the date of the first meeting from the third quarter of 2014 to the fourth quarter of 2014. The initial meeting was held on October 28, 2014. A copy of the presentation made to the OPUC is available on their website at the following location: http://www.puc.state.or.us/meetings/pmemos/2014/102814-pac/pacpresentation.pdf The first quarter 2015 meeting was held March 16, 2015.
Order No. 14-252, p. 3	In future IRPs, PacifiCorp will provide: <ul style="list-style-type: none"> • Timelines and key decision points for expected pollution control options and transmission investments; and • Tables detailing major planned expenditures with estimated costs in each year for each plant or transmission project, under different modeled scenarios. 	Volume III contains timelines that outline key decision points for pollution control options at Wyodak, Naughton Unit 3, Dave Johnston Unit 3, and Cholla Unit 4. Volume III further contains tables detailing major planned expenditures by year specific to each compliance scenario studied for Wyodak, Naughton Unit 3, Dave Johnston Unit 3, and Cholla Unit 4. Additional annual cost detail for existing coal units modeled among four different Regional Haze scenarios applied during the resource portfolio development process are included in Confidential data disks files with the 2015 IRP.
Order No. 14-252, p. 5	Rather than detail a specific coal analysis that will be required in the future, we instead direct the participants to schedule several workshops, at least one of which we will attend, to be held within the next six months to determine the parameters of coal analyses in future IRPs.	PacifiCorp held a total of four workshops dedicated solely to the modeling approach for coal plant investments. These meetings were attended by OPUC Staff and intervening parties to the 2013 IRP filed under Docket LC 57. The OPUC Commissioners attended the fourth workshop, held on August 6, 2014. Following the final workshop, Staff presented a memo at the OPUC public meeting outlining what they described as “an appropriate coal analysis framework for PacifiCorp’s 2015 Integrated Resource Plan.” The OPUC later issued Order No. 14-296 memorializing the analysis framework as presented by Staff. PacifiCorp met all requirements of this Order in its analysis summarized in Volume III. Additionally, the analysis approach was also discussed fully with all stakeholders at the September 25-26, 2014 Public Input Meeting.

Reference	IRP Requirement or Recommendation	How the Requirement or Recommendation is Addressed in the 2015 IRP
Order No. 14-252, p. 6	OPUC Commission modified Action Item 8a for Naughton Unit 3 to read as follows: Evaluate the Naughton Unit 3 investment decision in the 2015 IRP with updated analysis, including the option of shutdown versus conversion.	The required analysis is included in Volume III.
Order No. 14-252, p. 10	The modified Action Item 8d is: Continue to evaluate alternative compliance strategies that will meet Regional Haze compliance obligations, related to the US. Environmental Protection Agency's Federal Implementation Plan requirements to install SCR equipment at Cholla Unit 4. Provide an analysis of the Cholla Unit 4 compliance alternatives in a special, designated IRP Update within six months of the final order in LC 57 and well enough in advance to allow for all viable pollution control alternatives to be adequately considered and pursued.	On September 29, 2014 PacifiCorp filed a Special Update to the 2013 IRP containing the Cholla analysis as directed by the OPUC. The analysis presented in the special update is also included in the Volume III of the 2015 IRP.
Order No. 14-252, p. 10	Within three months of the order in this proceeding, PacifiCorp will schedule and hold a confidential technical workshop to review existing analysis on planned Craig and Hayden environmental investments.	A special public meeting was held on August 6, 2014 to provide the requested analysis. The meeting was confidential, limited to parties subject to the confidentiality provisions included with Docket LC 57.
Order No. 14-252, p. 13	Prior to the end of 2014, PacifiCorp will work with participants to explore options for how PacifiCorp plans to model and perform analysis in the 2015 IRP related to what is known about the requirements of §111(d) of the Clean Air Act.	PacifiCorp discussed its 111(d) modeling approach with Oregon stakeholders at the coal analysis workshops, discussed above. OPUC Commissioners attended the workshop on August 6, 2014. PacifiCorp further discussed its 111(d) modeling approach at multiple public input meetings and hosted two technical workshops (one in Portland and one in Salt Lake City) to demonstrate the use of the 111(d) Scenario Maker spreadsheet tool developed for the 2015 IRP for the sole purpose of modeling 111(d) policy and compliance uncertainties.
Order No. 14-252, p. 13	In the acknowledgement order the Commission provided the following recommendation: As part of the 2015, 2017, and 2019 IRPs, PacifiCorp will provide an updated version of the screening tool spreadsheet model that was provided to participants in the 2011 (docket LC 52) IRP Update.	PacifiCorp has provided three different versions of the screening model. These models are specific for different variations of Regional Haze scenarios analyzed in the 2015 IRP. The models are included on the confidential data disks filed with the 2015 IRP.
Order No. 14-252, p. 16	Provide twice yearly updates on the status of DSM IRP acquisition goals to the Commission in 2014 and 2015, including a summary of DSM acquisitions from large special contract customers.	PacifiCorp provided two DSM updates to the OPUC in 2014. The first update was on August 6, 2014, and the second was on December 3, 2014. A third meeting was held March 10, 2015.
Order No. 14-252, p. 16	Include in the 2014 conservation potential study information specific to PacifiCorp's service territory for all states other than Oregon that quantifies how much Class 2 DSM programs can be accelerated and how much it will cost to accelerate	The conservation potential study contains the requested information. It is available on the 2015 IRP data disk and online, with all appendices at the following location: http://www.pacificorp.com/es/dsm.html

Reference	IRP Requirement or Recommendation	How the Requirement or Recommendation is Addressed in the 2015 IRP
	acquisition.	
Order No. 14-252, p. 16	Include a PacifiCorp service area specific implementation plan as part of the 2015 IRP filing.	Appendix D contains the implementation plan as requested.
Order No. 14-252, p. 16	In future IRPs, PacifiCorp will provide yearly Class 1 and Class 2 DSM acquisition targets in both GWh and MW for each year in the planning period, by state.	See Appendix D for the breakdown by state and year for both energy and capacity selected for the preferred portfolio.
Order No. 14-252, p. 20	Order 14-252 modified Action Item 9b to read: Continue permitting Segments D, E, F, and H until PacifiCorp files its 2015 IRP, at which time a SBT analysis for these segments will be performed.	See the 2013 IRP Action Plan Status Update in Volume I, Chapter 9 which includes the following: PacifiCorp has continued to permit the Segments as discussed above. The Company is not proposing an acknowledgement Action Item for the Segments in the 2015 IRP – thus there is not an SBT analysis provided.
Utah		
Order, Docket No. 13-2035-01, p. 14.	Because EPA’s proposed and final implementation plans and challenges to those implementation plans continue to fluctuate, we encourage PacifiCorp to continue to monitor and prudently respond to the constantly changing landscape in its IRP update to be filed in 2014 (2013 IRP Update) and in the 2015 IRP.	PacifiCorp is fully engaged in state and EPA Regional Haze implementation plan activity. Background on Regional Haze is provided in Volume I, Chapter 3. Prospective Regional Haze requirements and potential compliance outcomes are considered in the 2015 IRP resource portfolio development process (Volume I, Chapter 7 and Volume I, Chapter 8). Impacts of Regional Haze outcomes are assessed in the 2015 IRP acquisition path analysis (Volume I, Chapter 9). PacifiCorp provides a detailed update on Regional Haze requirements Wyodak, Naughton Unit 3, Dave Johnston Unit 3, and Cholla Unit 4 in Volume III. Action items related to these coal units are outlined in Volume I, Chapter 9.
Order, Docket No. 13-2035-01, p. 15.	While the SBT shows some promise in demonstrating non-modeled benefits and costs, we are not persuaded it adequately identifies these benefits in the 2013 IRP... However, PacifiCorp should continue to discuss with state agencies and other interested parties how best to consider this information in the identification of a preferred portfolio prior to its use.	PacifiCorp held several workshops with interested stakeholders to discuss options for quantifying potential transmission benefits. See Volume I, Chapter 9, Action Item 9a update for more information. Going forward, PacifiCorp will develop cost and benefit support for transmission projects for which it is seeking Commission acknowledgement.
Order, Docket No. 13-2035-01, p. 15.	The Division and other parties indicate the IRP process is difficult and time-consuming...Further, we understand process improvements are being discussed informally, which we encourage.	The Company held a meeting on September 23, 2013 to discuss potential improvements in the IRP process, as well as accepting written comments from stakeholders. These comments and suggestions resulted in several changes to the 2015 IRP. Some examples include scheduling multi-day public input meetings to ensure there is adequate time to cover topics thoroughly, addition of a Feedback Form for stakeholders to provide comments throughout the public input process. Comments received through this process directly influenced assumptions and

Reference	IRP Requirement or Recommendation	How the Requirement or Recommendation is Addressed in the 2015 IRP
		<p>core case definitions adopted for the 2015 IRP. PacifiCorp is also increasing transparency by including data disks with its 2015 IRP filing, and held technical workshops on new models introduced to the 2015 IRP (the 111(d) Scenario Maker model). PacifiCorp further improved its modeling approach by including estimates of transmission integration and reinforcement costs specific to each unique resource portfolio.</p>
<p>Order, Docket No. 13-2035-01, p. 17.</p>	<p>As we have stated in the past, sensitivity analysis should be an effective tool for evaluating the effect on resource selection of various assumptions regarding solar and wind resource costs. We recognize there are differences of opinion, and some uncertainties, regarding renewable resource cost assumptions. We encourage PacifiCorp and stakeholders to develop a strategy to address this issue in the 2015 IRP. Further, the results of this effort could be utilized in PacifiCorp’s acquisition path analysis to inform decisions if the future unfolds differently than expected.</p>	<p>See Volume I, Chapter 6 for discussion related to cost assumptions related to new resources. Resource cost assumptions were reviewed and discussed with stakeholders at the August 7, 2014 public input meeting. As part of the 2015 IRP PacifiCorp requested stakeholder feedback on all topics, including renewable resource costs, which resulted in sensitivity around potential future solar costs (S-12) with assumptions provided by members of the stakeholder group. Sensitivity assumptions are discussed in Volume I, Chapter 7. Sensitivity results are provided in Volume I, Chapter 8.</p>
<p>Order, Docket No. 13-2035-01, p. 19.</p>	<p>UCE questions the annual limit of available rooftop solar resource in Utah...We support PacifiCorp’s commitment to address this issue in the 2015 IRP cycle.</p>	<p>PacifiCorp has included an updated distributed generation (DG) assessment, prepared by Navigant Consulting, in the 2015 IRP. This DG assessment is used to support DG penetration levels (inclusive of rooftop solar and other DG technologies) among base, low and high scenarios. The study is discussed in Volume I, Chapter 5, and included in Volume II, Appendix O.</p>
<p>Order, Docket No. 13-2035-01, p. 19.</p>	<p>PacifiCorp’s treatment of RECs in the 2013 IRP is questioned by several parties. First, in its replacement of 208 megawatts of wind resource in the Preferred Portfolio with unbundled RECs, PacifiCorp does not analyze the comparative risks of the two alternatives, essentially concluding that a wind resource and an unbundled REC carry the same risks for customers. Parties argue this conclusion should be tested rather than assumed. Second, parties argue the value of a REC should be included in the cost of a renewable resource as an offset. We direct PacifiCorp to further address both of these issues in the 2013 IRP Update.</p>	<p>PacifiCorp addressed this issue in the 2013 IRP Update as directed. Please see pages 45-46 of the 2013 IRP Update for discussion on the Renewable Energy Credit value.</p>
<p>Order, Docket No. 13-2035-01, p. 19-20.</p>	<p>UCE and Interwest argue PacifiCorp’s assumed capacity contribution at the time of peak demand for wind and solar resources is understated and is inconsistent with the method and values approved by the Commission in its August 16, 2013, Order on Phase II Issues in Docket No. 12-035-100 (“August Order”) on avoided costs for qualifying facilities (“QF”s)...In the 2013 IRP Update we direct PacifiCorp to perform</p>	<p>PacifiCorp’s 2013 IRP Update contained the sensitivity case as directed. These renewable sensitivities are discussed on pages 59-67 of the 2013 IRP Update, with the specific capacity sensitivity results on page 67. PacifiCorp further produced a solar and wind capacity contribution study in support of its 2015 IRP. This study is provided in Volume II, Appendix N.</p>

Reference	IRP Requirement or Recommendation	How the Requirement or Recommendation is Addressed in the 2015 IRP
	a sensitivity case with stochastic analysis using the values in the August Order for wind and solar capacity contribution.	
Order, Docket No. 13-2035-01, p. 22.	The Office recommends the Commission require PacifiCorp “to provide a contingency plan for the IRP’s heavy reliance on [front office transactions] to be used in the event that market supplies tighten and prices increase significantly...We encourage PacifiCorp to examine the Office’s recommendation in the 2015 IRP cycle. Such analysis could be included in the section of the IRP devoted to acquisition path analysis.	PacifiCorp discusses its assumed market limits in Volume I, Chapter 6. Modeling of market purchases is discussed in Volume I, Chapter 7. Core case definitions include a scenario that limits market purchases at NOB and Mona (Volume I, Chapter 7), which is used to address market limits in the acquisition path analysis (Volume I, Chapter 9). PacifiCorp provides an assessment of western resource adequacy in Volume II, Appendix J. With reduced loads, increasing DG penetration, and increased DSM acquisition, market purchases in the 2015 IRP preferred portfolio are down by 29% through 2024 relative to the 2013 IRP preferred portfolio.
Order, Docket No. 13-2035-01, p. 23.	We accept a 13 percent planning reserve as reasonable for this IRP and recommend continued analysis of this issue, both through LOLP study and tradeoff analysis.	PacifiCorp presented the results of its Planning Reserve Margin study at the September 25-26 public input meeting. The study itself is included as Volume II, Appendix I.
Order, Docket No. 13-2035-01, p. 23-24.	We direct PacifiCorp to present in the 2015 IRP an analysis of whether the available historical cooling degree day information is an appropriate predictor of future “normal” conditions and, if warranted, to identify and implement a superior predictor in that IRP.	This topic was addressed at the July 17-18, 2014 public input meeting and discussed in Appendix A. In short, the peak producing weather has not changed significantly when looking at five, ten, or twenty year averages. As such, PacifiCorp has not adjusted the historic time period for load forecasting.
Order, Docket No. 13-2035-01, p. 24.	UCE and WRA also dispute PacifiCorp’s decision to eliminate the long-run load volatility parameter from its stochastic analysis. PacifiCorp argues this parameter produces results that are not useful for comparing the costs and risks of portfolios and that it is more appropriate to study long-term load risk through load forecast scenario analysis. We direct PacifiCorp to facilitate a discussion of this issue in the 2015 IRP cycle.	Stochastic parameters were discussed at the August 7-8, 2014 public input meeting as well as the September 25-26, 2014 public input meeting. PacifiCorp continues to use short-term volatility and mean reversion parameters to model load volatility. Long-term load uncertainties are analyzed using load sensitivity analysis, described in Volume I, Chapter 7 with results presented in Volume I, Chapter 8. These sensitivities inform the 2015 IRP acquisition path analysis in Volume I, Chapter 9.
Order, Docket No. 13-2035-01, p. 24	The Division notes PacifiCorp includes historic load data in the 2013 IRP. We note the annual coincident peak load data by state in Table A.7 on page 13 of Appendix A, appears rather to provide each state’s highest monthly peak load which is coincident with the system rather than its load coincident with the time of annual system peak. PacifiCorp should correct this table and provide it in its 2013 IRP Update.	A corrected table was provided as Appendix E in the 2013 IRP Update.
Order, Docket No. 13-2035-01, p. 25.	The Division notes PacifiCorp includes in Table 9.2, “an excellent summary of actions [PacifiCorp] may undertake should the future start to turn out	See Volume I, Chapter 9, specifically Table 9.3 for the acquisition path analysis discussion.

Reference	IRP Requirement or Recommendation	How the Requirement or Recommendation is Addressed in the 2015 IRP
	significantly different than anticipated as reflected in [PacifiCorp’s] preferred portfolio.” We concur with the Division this is a very useful table and we encourage PacifiCorp to expand its use of this table in its 2013 IRP Update and 2015 IRP to address additional issues.	
Order, Docket No. 13-2035-01, p. 25.	WRA and UCE request PacifiCorp conduct a workshop on its stochastic risk modeling. We find this to be a reasonable request and suggest PacifiCorp include this topic in a separate workshop in its 2015 IRP cycle.	Stochastic modeling was a topic at several of the public input meetings: August 7-8, 2014 and September 25-26, 2014. The results of the stochastic modeling were presented at the January 29-30, 2015 public input meeting.
Order, Docket No. 13-2035-01, pp. 25-26.	The Division and other parties state PacifiCorp did not perform the third stage of the three stage process outlined in the Commission’s Report and Order on PacifiCorp’s 2008 IRP in Docket No. 09-2035-01 (“2008 Order”)...We agree that, although not a required Guideline, the third stage identifies an optimal portfolio that is robust across different uncertain futures and we encourage PacifiCorp to utilize the third stage in the 2015 IRP.	PacifiCorp included a deterministic risk analysis (the “third stage” as referenced in the Commission Report and Order). The methodology is discussed in Volume I, Chapter 7. Results, used to inform selection of the preferred portfolio, are provided in Volume I, Chapter 8.
Order, Docket No. 13-2035-01, pp. 26-27.	We encourage PacifiCorp to work with stakeholders in the 2015 IRP cycle to ensure cases of interest to stakeholders, including sensitivity cases, are fully evaluated against cost, risk and performance measures.	For the 2015 IRP PacifiCorp developed a feedback form to capture, among other things, cases of interest to stakeholders. Two core cases of specific interest to stakeholders included those associates with EPA’s 111(d) rule implemented as a mass cap, cases with CO ₂ price assumptions incremental to 111(d) requirements, and a case with limited FOT availability. Sensitivity cases were also influenced by stakeholder comments, including sensitivities related to solar resource costs, high CO ₂ price assumptions, and 111(d) compliance. Sensitivity cases were also analyzed in PaR.
Order, Docket No. 13-2035-01, p. 28.	We note PacifiCorp provided a link to access the 2013 DSM Potentials Study in the 2013 IRP but did not file it as required. We direct PacifiCorp to file the 2013 DSM Potentials Study in this docket within 45 days.	The study was filed on January 16, 2014 in Docket No. 13-2035-01 as required. The updated conservation potential study is saved to data disks filed with the 2015 IRP.
Order, Docket No. 13-2035-01, p. 30.	We note PacifiCorp did not present the Business Plan as a sensitivity case in the 2013 IRP. We remind PacifiCorp to provide this sensitivity in the 2013 IRP Update and all future IRPs.	The 2013 IRP Update contained a sensitivity on the Business Plan. See pages 56-58 specifically for the analysis. Utah Commission Staff suggested this requirement be met by discussing the business plan in the context of the acquisition path analysis. PacifiCorp notes in its acquisition path analysis that resource changes in resource procurement strategies driven by changes in the planning environment are captured in the IRP and future business plan cycles. PacifiCorp further explains differences between its fall 2014 ten-year business plan resource portfolio and the 2015 IRP preferred portfolio in Volume I, Chapter 9.

Reference	IRP Requirement or Recommendation	How the Requirement or Recommendation is Addressed in the 2015 IRP
Washington		
UE-120416, p. 2.	PacifiCorp should continue purchasing RECs through requests for proposals at regular intervals to ensure that the REC-based compliance strategy remains the lowest-cost option.	The Company has issued RFPs to meet Washington requirements in both 2013 and 2014. Bids were selected with compelling price and/or structure criteria. See also Volume I, Chapter 9 for further discussion. The 2015 IRP action plan calls for further REC RFPs to meet projected Washington RPS requirements.
UE-120416, p. 3.	Depending on how the new regulations for existing coal plants are implemented and how much authority and flexibility is afforded to state air quality and economic regulators, these regulations will likely place a price on carbon, either directly or indirectly. Therefore, we request that the Company's modeling account for the possible range of carbon prices consistent with regulations developed under Section 111(d) of the Clean Air Act, 42 U.S.C. Sec. 7411, for existing plants.	The 2015 IRP includes extensive modeling to address 111(d) policy and compliance uncertainties. PacifiCorp's 111(d) modeling approach and case definitions are described in Volume I, Chapter 7. Results are presented in Volume I, Chapter 8. Summaries of each case, including representation of 111(d) compliance by state is included in case fact sheets provided in Volume II, Appendix M. PacifiCorp further included core cases and sensitivity cases that impose CO ₂ prices that are incremental to assumed 111(d) requirements.
UE-120416, pp. 3-4.	The Company's original approach using a wide range of future natural gas price assumptions was instructive. However, a more detailed analysis that focuses on the gaps between the various projections that the Company used and identifies the price level at which it would become cost-effective to switch an existing coal plant to natural gas is required to better inform the Company's decision-making process. Given these developments, the Commission concludes that PacifiCorp should update its coal analysis as part of its 2013 IRP Update.	PacifiCorp provided a breakeven analysis as requested in Confidential Appendix F of the 2013 IRP Update.
UE-120416, p. 4.	The Commission appreciates the IRP's in-depth attention to transmission planning. The System Operational and Reliability Benefits Tool (SBT) that the Company has developed to analyze potential new transmission investments has the potential to more accurately portray the economics of transmission projects... The Company should continue to engage stakeholders in the refinement of this evolving and potentially important transmission planning tool.	PacifiCorp solicited stakeholder participation in an SBT workgroup in June, 2013. There were a total of four workshops held to discuss refinement of the tools. PacifiCorp will develop cost and benefit support for transmission projects for which it is seeking Commission acknowledgement. See Action Item 9A in Table 9.2 – 2013 IRP Action Plan Status Update for further discussion.
UE-120416, p. 5.	Therefore we believe it is both impractical and unrealistic to use a zero cost of carbon in the base case, or business-as-usual case, in the next IRP cycle. PacifiCorp's next IRP must include a non-zero cost of carbon in its base case.	PacifiCorp has not assumed a zero cost of carbon base case for many IRP cycles. For the 2015 IRP, PacifiCorp's base case incorporates EPA's proposed 111(d) rule (see Volume I, Chapter 7). PacifiCorp further includes scenarios that impose a CO ₂ price incremental to 111(d) requirements.
UE-120416, p. 5.	The Company's 2015 IRP should also examine ways in which PacifiCorp can contribute to Washington's goal of reducing carbon emissions to 1990 levels	See Volume I, Chapter 8 for an assessment of portfolios that meet Washington's goal of reducing carbon emissions to 1990 levels by 2020.

Reference	IRP Requirement or Recommendation	How the Requirement or Recommendation is Addressed in the 2015 IRP
	by 2020 and evaluate the rate impacts of any such measure.	
UE-120416, pp. 5-6.	In its 2011 IRP Acknowledgment letter, the Commission requested that the Company model its West and East control areas separately in the 2013 IRP. The Company must model the two areas separately in the next IRP as a prerequisite for acknowledgment.	PacifiCorp included sensitivity case S-10 that meets this requirement. See Volume I, Chapter 7 for a description of the sensitivity case and Volume I, Chapter 8 for presentation of the results.
UE-120416, p. 6.	The Commission requests that the Company update its energy storage analysis and use more current data as an input to the 2015 IRP.	PacifiCorp completed an update to the Energy Storage Screening Study as discussed in Volume I, Chapter 6. A copy of the study is included on the data disks filed with the 2015 IRP.
UE-120416, p. 6.	Regarding anaerobic digesters, the Commission believes that PacifiCorp's modeling in the IRP process did not address adequately the Commission's 2011 request for the Company to analyze the potential for this technology in its Washington service territory...We expect a rigorous analysis of the potential for this form of generation in the next IRP cycle.	In 2014, PacifiCorp commissioned Harris Group Incorporated to perform an extensive assessment on power generation potential from anaerobic digestion. See Volume I, Chapter 6 for discussion of the results and the full study is included on the data disks filed with the 2015 IRP. Additionally, a public presentation on the report findings was prepared and made at the 2015 Integrated Resource Plan Public Input Meeting 4 on September 25, 2014.
UE-120416, p. 7.	Additionally, the Commission expects that PacifiCorp's 2015 IRP will contain a more robust analysis of smart grid technologies and potential opportunities for the Company recognizing that, like electric storage, this technology is dynamic and potentially becoming more cost-effective over time.	See Appendix E for discussion of smart grid.
Wyoming		
<p>The Wyoming Public Service Commission provided the following comment in its Letter Order (Docket No. 20000-424-EA-13, record No. 13425, dated September 4, 2013) on PacifiCorp's 2011 IRP:</p> <p><i>Pursuant to open meeting action taken on August 29, 2013, Rocky Mountain Power's 2013 Integrated Resource Plan is hereby placed in the Commission's files. No further action will be taken and this matter is closed.</i></p>		

Table B.3 – Oregon Public Utility Commission IRP Standard and Guidelines

No.	Requirement	How the Guideline is Addressed in the 2015 IRP
Guideline 1. Substantive Requirements		
1.a.1	All resources must be evaluated on a consistent and comparable basis: All known resources for meeting the utility’s load should be considered, including supply-side options which focus on the generation, purchase and transmission of power – or gas purchases, transportation, and storage – and demand-side options which focus on conservation and demand response.	PacifiCorp considered a wide range of resources including renewables, DSM, energy storage, power purchases, thermal resources, and transmission. Volume I, Chapter 4 (Transmission Planning), Chapter 6 (Resource Options), and Chapter 7 (Modeling and Portfolio Evaluation Approach) document how PacifiCorp developed these resources and modeled them in its portfolio analysis. All these resources were established as resource options in the Company’s capacity expansion optimization model, System Optimizer, and selected by the model based on load requirements, relative economics, resource size, availability dates, and other factors.
1.a.2	All resources must be evaluated on a consistent and comparable basis: Utilities should compare different resource fuel types, technologies, lead times, in-service dates, durations and locations in portfolio risk modeling.	All portfolios developed with System Optimizer were subjected to Monte Carlo production cost simulation. These portfolios contained a variety of resource types with different fuel types (coal, gas, biomass, nuclear fuel, and “no fuel” renewables), lead-times, in-service dates, operational lives, and locations. See Volume I, Chapter 7 (Modeling and Portfolio Evaluation Approach), Chapter 8 (Modeling and Portfolio Selection Results), and Volume II, Appendix K (Detail Capacity Expansion Results) and Appendix L (Stochastic Production Cost Simulation Results).
1.a.3	All resources must be evaluated on a consistent and comparable basis: Consistent assumptions and methods should be used for evaluation of all resources.	PacifiCorp fully complies with this requirement. The Company developed generic supply-side resource attributes based on a consistent characterization methodology. For demand-side resources, the company used supply curves supported by an updated conservation potential assessment (CPA), specific to PacifiCorp’s service territory. The CPA was based on a consistently applied methodology for determining technical, market, and achievable DSM potentials. All portfolio resources were evaluated using the same sets of price and load forecast inputs. These inputs are documented in Volume I, Chapter 5 (Resource Needs Assessment), Chapter 6 (Resource Alternatives), and Chapter 7 (Modeling and Portfolio Evaluation Approach) as well as Volume II, Appendix D (Demand-Side Management and Supplemental Resources).
1.a.4	All resources must be evaluated on a consistent and comparable basis: The after-tax marginal weighted-average cost of capital (WACC) should be used to discount all future resource costs.	PacifiCorp applied its after-tax WACC of 6.66% to discount all cost and revenue streams.

No.	Requirement	How the Guideline is Addressed in the 2015 IRP
1.b.1	Risk and uncertainty must be considered: At a minimum, utilities should address the following sources of risk and uncertainty: 1. Electric utilities: load requirements, hydroelectric generation, plant forced outages, fuel prices, electricity prices, and costs to comply with any regulation of greenhouse gas emissions.	PacifiCorp performs stochastic risk modeling of load, price, hydro generation, and thermal outage variables in PaR. Price scenarios are also used in PaR to perform cost and risk analysis among resource portfolios. Load scenarios are further tested in sensitivity analysis. CO ₂ policy risk and uncertainty is analyzed via scenario analysis. The 2015 IRP includes extensive analysis of 111(d) policy and compliance uncertainties and includes cases where CO ₂ prices are applied incremental to assumed compliance requirements stemming from EPA’s draft 111(d) rule. See Volume I, Chapter 7 (Modeling and Portfolio Evaluation Approach).
1.b.2	Risk and uncertainty must be considered: Utilities should identify in their plans any additional sources of risk and uncertainty.	Resource risk mitigation is discussed in Volume I, Chapter 9 (Action Plan and Resource Procurement).
1.c	The primary goal must be the selection of a portfolio of resources with the best combination of expected costs and associated risks and uncertainties for the utility and its customers (“best cost/risk portfolio”).	PacifiCorp evaluated cost/risk tradeoffs for each of the portfolios considered. See Volume I, Chapter 8 (Modeling and Portfolio Selection Results), Volume I, Chapter 9 (Action Plan), and Volume II, Appendix K (Detailed Capacity Expansion Results) and Volume II, Appendix L (Stochastic Production Cost Simulation Results) for the Company’s portfolio cost/risk analysis and determination of the preferred portfolio.
1.c.1	The planning horizon for analyzing resource choices should be at least 20 years and account for end effects. Utilities should consider all costs with a reasonable likelihood of being included in rates over the long term, which extends beyond the planning horizon and the life of the resource.	PacifiCorp used a 20-year study period (2015-2034) for portfolio modeling, and a real levelized revenue requirement methodology for treatment of end effects.
1.c.2	Utilities should use present value of revenue requirement (PVRR) as the key cost metric. The plan should include analysis of current and estimated future costs for all long-lived resources such as power plants, gas storage facilities, and pipelines, as well as all short-lived resources such as gas supply and short-term power purchases.	Volume I, Chapter 7 (Modeling and Portfolio Evaluation Approach) provides a description of the PVRR methodology. Resource cost assumptions and resource life assumptions are outlined in Chapter 6 (Resource Options).
1.c.3.1	To address risk, the plan should include, at a minimum: 1. Two measures of PVRR risk: one that measures the variability of costs and one that measures the severity of bad outcomes.	PacifiCorp uses the standard deviation of stochastic production costs as the measure of cost variability. See Volume II Appendix L (Stochastic Production Cost Simulation Results). For the severity of bad outcomes, the Company calculates several measures, including stochastic upper-tail mean PVRR (mean of highest three Monte Carlo iterations) and the 95 th percentile stochastic production cost PVRR. See Volume I, Chapter 7 (Modeling and Portfolio Evaluation Approach), as well as Volume II Appendix L (Stochastic Production Cost Simulation Results).

No.	Requirement	How the Guideline is Addressed in the 2015 IRP
1.c.3.2	To address risk, the plan should include, at a minimum: 2. Discussion of the proposed use and impact on costs and risks of physical and financial hedging.	A discussion on hedging is provided in Volume I, Chapter 9 (Action Plan and Resource Procurement).
1.c.4	The utility should explain in its plan how its resource choices appropriately balance cost and risk.	Volume I, Chapter 8 (Modeling and Portfolio Selection Results) summarizes the results of PacifiCorp’s cost/risk tradeoff analysis, and describes what criteria the Company used to determine the best cost/risk portfolios and the preferred portfolio.
1.d	The plan must be consistent with the long-run public interest as expressed in Oregon and federal energy policies.	PacifiCorp considered both current and potential state and federal energy/pollutant emission policies in portfolio modeling. Volume I, Chapter 7 (Modeling and Portfolio Evaluation Approach) describes the decision process used to derive portfolios, which includes consideration of state and federal resource policies and regulations that are summarized in Volume I, Chapter 3 (The Planning Environment). Volume I, Chapter 8 (Modeling and Portfolio Selection Results) provides the results. Volume I, Chapter 9 (Action Plan) presents an acquisition path analysis that describes resource strategies based on trigger events.
Guideline 2. Procedural Requirements		
2.a	The public, which includes other utilities, should be allowed significant involvement in the preparation of the IRP. Involvement includes opportunities to contribute information and ideas, as well as to receive information. Parties must have an opportunity to make relevant inquiries of the utility formulating the plan. Disputes about whether information requests are relevant or unreasonably burdensome, or whether a utility is being properly responsive, may be submitted to the Commission for resolution.	PacifiCorp fully complies with this requirement. Volume I, Chapter 2 (Introduction) provides an overview of the public process, all public meetings held for the 2015 IRP, which are documented in Volume II, Appendix C (Public Input Process). PacifiCorp also made use of a Feedback Form for stakeholders to provide comments and offer suggestions.
2.b	While confidential information must be protected, the utility should make public, in its plan, any non-confidential information that is relevant to its resource evaluation and action plan. Confidential information may be protected through use of a protective order, through aggregation or shielding of data, or through any other mechanism approved by the Commission.	2015 IRP Volumes I and II provide non-confidential information the Company used for portfolio evaluation, as well as other data requested by stakeholders. PacifiCorp also provided stakeholders with non-confidential information to support public meeting discussions via email. Volume III of the 2015 IRP is confidential and is protected through the use of a protective order. Data disks will be available with public data. Additionally, data disks with confidential data are protected through use of a protective order.

No.	Requirement	How the Guideline is Addressed in the 2015 IRP
2.c	The utility must provide a draft IRP for public review and comment prior to filing a final plan with the Commission.	<p>PacifiCorp distributed draft IRP materials for external review throughout the process prior to each of the public input meetings and solicited/and received feedback at various times when developing the 2015 IRP. The materials shared with stakeholders at these meetings, outlined in Volume I Chapter 2 (Introduction), is consistent with materials presented in Volumes I, II, and III of the 2015 IRP report.</p> <p>PacifiCorp requested and responded to comments from stakeholders in developing core case and sensitivity definitions. The Company considered comments received via the Feedback form in developing its final plan.</p>
Guideline 3: Plan Filing, Review, and Updates		
3.a	A utility must file an IRP within two years of its previous IRP acknowledgment order. If the utility does not intend to take any significant resource action for at least two years after its next IRP is due, the utility may request an extension of its filing date from the Commission.	The 2015 IRP complies with this requirement.
3.b	The utility must present the results of its filed plan to the Commission at a public meeting prior to the deadline for written public comment.	This activity will be conducted subsequent to filing this IRP.
3.c	Commission staff and parties should complete their comments and recommendations within six months of IRP filing.	This activity will be conducted subsequent to filing this IRP.
3.d	The Commission will consider comments and recommendations on a utility’s plan at a public meeting before issuing an order on acknowledgment. The Commission may provide the utility an opportunity to revise the IRP before issuing an acknowledgment order.	This activity will be conducted subsequent to filing this IRP.
3.e	The Commission may provide direction to a utility regarding any additional analyses or actions that the utility should undertake in its next IRP.	Not applicable.
3.f	(a) Each energy utility must submit an annual update on its most recently acknowledged IRP. The update is due on or before the acknowledgment order anniversary date. Once a utility anticipates a significant deviation from its acknowledged IRP, it must file an update with the Commission, unless the utility is within six months of filing its next IRP. The utility must summarize the update at a Commission public meeting. The utility may request acknowledgment of changes in proposed actions identified in an update.	This activity will be conducted subsequent to filing this IRP.
3.g	Unless the utility requests acknowledgment of	This activity will be conducted subsequent to filing

No.	Requirement	How the Guideline is Addressed in the 2015 IRP
	<p>changes in proposed actions, the annual update is an informational filing that:</p> <ul style="list-style-type: none"> • Describes what actions the utility has taken to implement the plan; • Provides an assessment of what has changed since the acknowledgment order that affects the action plan to select best portfolio of resources, including changes in such factors as load, expiration of resource contracts, supply-side and demand-side resource acquisitions, resource costs, and transmission availability; and • Justifies any deviations from the acknowledged action plan. 	this IRP.
Guideline 4. Plan Components: At a minimum, the plan must include the following elements		
4.a	An explanation of how the utility met each of the substantive and procedural requirements.	The purpose of this table is to comply with this guideline.
4.b	Analysis of high and low load growth scenarios in addition to stochastic load risk analysis with an explanation of major assumptions.	PacifiCorp developed low, high, and extreme peak temperature (one-in-twenty probability) load growth forecasts for scenario analysis using the System Optimizer model. Stochastic variability of loads was also captured in the risk analysis. See Volume I, Chapters 5 (Resource Needs Assessment) and Volume I, Chapter 7 (Modeling and Portfolio Evaluation Approach), and Volume II, Appendix A (Load Forecast) for load forecast information.
4.c	For electric utilities, a determination of the levels of peaking capacity and energy capability expected for each year of the plan, given existing resources; identification of capacity and energy needed to bridge the gap between expected loads and resources; modeling of all existing transmission rights, as well as future transmission additions associated with the resource portfolios tested.	See Volume I, Chapter 5 (Resource Need Assessment) for details on annual capacity and energy balances. Existing transmission rights are reflected in the IRP model topologies. Future transmission additions used in analyzing portfolios are summarized in Volume I, Chapter 4 (Transmission) and Volume I, Chapter 7 (Modeling and Portfolio Evaluation Approach). Results of sensitivity analysis with future transmission projects are summarized in Volume I, Chapter 8.
4.d	For gas utilities only	Not applicable
4.e	Identification and estimated costs of all supply-side and demand side resource options, taking into account anticipated advances in technology	Volume I, Chapter 6 (Resource Options) identifies the resources included in this IRP, and provides their detailed cost and performance attributes. Additional information on energy efficiency resource characteristics is available in Volume II, Appendix D (Demand-Side Management and Supplemental Resources).
4.f	Analysis of measures the utility intends to take to provide reliable service, including cost-risk tradeoffs	In addition to incorporating a 13% planning reserve margin for all portfolios evaluated, as supported by an updated planning reserve margin study (Volume II, Appendix I), the Company used several measures to evaluate relative portfolio supply reliability. These measures (Energy Not Served and Loss of Load Probability), which are described in Volume I, Chapter 7 (Modeling and Portfolio Evaluation Approach).
4.g	Identification of key assumptions about the future (e.g., fuel prices and environmental	Volume I, Chapter 7 (Modeling and Portfolio Evaluation Approach) describes the key assumptions

No.	Requirement	How the Guideline is Addressed in the 2015 IRP
	compliance costs) and alternative scenarios considered	and alternative scenarios used in this IRP. Volume II, Appendix M (Case Study Fact Sheets) includes summaries of assumptions used for each case definition analyzed in the 2015 IRP.
4.h	Construction of a representative set of resource portfolios to test various operating characteristics, resource types, fuels and sources, technologies, lead times, in-service dates, durations and general locations – system-wide or delivered to a specific portion of the system	This Plan documents the development and results of portfolios designed to determine resource selection under a variety of input assumptions in Volume I, Chapter 7 (Modeling and Portfolio Evaluation Approach) and Volume I, Chapter 8 (Modeling and Portfolio Selection Results).
4.i	Evaluation of the performance of the candidate portfolios over the range of identified risks and uncertainties	Volume I, Chapter 8 (Modeling and Portfolio Selection Results) presents the stochastic portfolio modeling results, and describes portfolio attributes that explain relative differences in cost and risk performance.
4.j	Results of testing and rank ordering of the portfolios by cost and risk metric, and interpretation of those results.	Volume I, Chapter 8 (Modeling and Portfolio Selection Results) provides tables and charts with performance measure results, including rank ordering.
4.k	Analysis of the uncertainties associated with each portfolio evaluated.	See responses to 1.b.1 and 1.b.2 above.
4.l	Selection of a portfolio that represents the best combination of cost and risk for the utility and its customers.	See 1.c above.
4.m	Identification and explanation of any inconsistencies of the selected portfolio with any state and federal energy policies that may affect a utility’s plan and any barriers to implementation.	This IRP is designed to avoid inconsistencies with state and federal energy policies therefore none are currently identified. Risks to resource procurement activities are addressed in Chapter 9 (Action Plan and Resource Procurement).
4.n	An action plan with resource activities the utility intends to undertake over the next two to four years to acquire the identified resources, regardless of whether the activity was acknowledged in a previous IRP, with the key attributes of each resource specified as in portfolio testing.	Volume I, Chapter 9 (Action Plan and Resource Procurement) presents the 2015 IRP action plan identifying resource actions required over the next two to four years.
Guideline 5: Transmission		
5	Portfolio analysis should include costs to the utility for the fuel transportation and electric transmission required for each resource being considered. In addition, utilities should consider fuel transportation and electric transmission facilities as resource options, taking into account their value for making additional purchases and sales, accessing less costly resources in remote locations, acquiring alternative fuel supplies, and improving reliability.	Costs for fuel transportation and transmission are factored into each resource portfolio evaluated for the 2015 IRP. Fuel transport costs are reflected in the fixed costs and/or variable fuel costs for each resource option, as applicable (Volume I, Chapter 6). Transmission costs include integration and reinforcement costs, specific to each resource portfolio (Volume I, Chapter 6 and Chapter 7). PacifiCorp further evaluated two sensitivities on Energy Gateway transmission project configurations on a consistent and comparable basis with respect to other resources. Where new resources would require additional transmission facilities the associated costs were factored into the analysis.

No.	Requirement	How the Guideline is Addressed in the 2015 IRP
Guideline 6: Conservation		
6.a	Each utility should ensure that a conservation potential study is conducted periodically for its entire service territory.	A multi-state conservation potential assessment was updated and used to support the 2015 IRP.
6.b	To the extent that a utility controls the level of funding for conservation programs in its service territory, the utility should include in its action plan all best cost/risk portfolio conservation resources for meeting projected resource needs, specifying annual savings targets.	PacifiCorp’s energy efficiency supply curves incorporate Oregon resource potential. Oregon potential estimates were provided by the Energy Trust of Oregon. See the demand-side resource section in Volume I, Chapter 6 (Resource Alternatives), the results in Volume I, Chapter 8 (Modeling and Portfolio Selection Results), the targeted amounts in Volume I, Chapter 9 (Action Plan and Resource Procurement). State implementation plans are included in Volume II, Appendix D.
6.c	To the extent that an outside party administers conservation programs in a utility’s service territory at a level of funding that is beyond the utility’s control, the utility should: <ol style="list-style-type: none"> 1. Determine the amount of conservation resources in the best cost/risk portfolio without regard to any limits on funding of conservation programs; and 2. Identify the preferred portfolio and action plan consistent with the outside party’s projection of conservation acquisition. 	See the response for 6.b above.
Guideline 7: Demand Response		
7	Plans should evaluate demand response resources, including voluntary rate programs, on par with other options for meeting energy, capacity, and transmission needs (for electric utilities) or gas supply and transportation needs (for natural gas utilities).	PacifiCorp evaluated demand response resources (Class 1 and 3 DSM) on a consistent basis with other resources.
Guideline 8: Environmental Costs		
8.a	Base case and other compliance scenarios: The utility should construct a base-case scenario to reflect what it considers to be the most likely regulatory compliance future for carbon dioxide (CO ₂), nitrogen oxides, sulfur oxides, and mercury emissions. The utility should develop several compliance scenarios ranging from the present CO ₂ regulatory level to the upper reaches of credible proposals by governing entities. Each compliance scenario should include a time profile of CO ₂ compliance requirements. The utility should identify whether the basis of those requirements, or “costs,” would be CO ₂ taxes, a ban on certain types of resources, or CO ₂ caps (with or without flexibility mechanisms such as allowance or credit trading as a safety valve). The analysis should recognize significant and important upstream emissions that would likely have a significant impact on resource decisions. Each	See Volume I, Chapter 7 (Modeling and Portfolio Evaluation Approach). PacifiCorp’s base scenario assumes implantation of EPA’s proposed 111(d) rule as an emission rate standard allowing flexible allocation of existing renewable resources among states to achieve compliance. Additional 111(d) policy scenarios and compliance strategies are also studied. Further, PacifiCorp studies CO ₂ policy scenarios with CO ₂ prices incremental to compliance requirements assumed in EPA’s draft 111(d) rule.

No.	Requirement	How the Guideline is Addressed in the 2015 IRP
	compliance scenario should maintain logical consistency, to the extent practicable, between the CO ₂ regulatory requirements and other key inputs.	
8.b	Testing alternative portfolios against the compliance scenarios: The utility should estimate, under each of the compliance scenarios, the present value revenue requirement (PVRR) costs and risk measures, over at least 20 years, for a set of reasonable alternative portfolios from which the preferred portfolio is selected. The utility should incorporate end-effect considerations in the analyses to allow for comparisons of portfolios containing resources with economic or physical lives that extend beyond the planning period. The utility should also modify projected lifetimes as necessary to be consistent with the compliance scenario under analysis. In addition, the utility should include, if material, sensitivity analyses on a range of reasonably possible regulatory futures for nitrogen oxides, sulfur oxides, and mercury to further inform the preferred portfolio selection.	Volume II, Appendix L (Stochastic Production Costs Simulation Results) provides the Stochastic mean PVRR versus upper tail mean less stochastic mean PVRR scatter plot diagrams that for portfolios developed with a range of compliance scenarios as summarized in 8.a above. The Company considers end-effects in its use of real levelized revenue requirement analysis, as summarized in Volume I, Chapter 7 (Modeling and Portfolio Evaluation Approach) and uses a 20-year planning horizon. A range of potential Regional Haze scenarios, reflecting hypothetical inter-temporal and fleet trade-off compliance outcomes. Detailed analysis of Regional Haze compliance alternatives for Wyodak, Naughton Unit 3, Dave Johnston Unit 3, and Cholla Unit 4 is included in Volume III. All studies in the 2015 IRP reflect assumed costs for compliance with known and prospective regulations (MATs, CCR, ELG, and cooling water intake structures), as applicable.
8.c	Trigger point analysis: The utility should identify at least one CO ₂ compliance “turning point” scenario, which, if anticipated now, would lead to, or “trigger” the selection of a portfolio of resources that is substantially different from the preferred portfolio. The utility should develop a substitute portfolio appropriate for this trigger-point scenario and compare the substitute portfolio’s expected cost and risk performance to that of the preferred portfolio – under the base case and each of the above CO ₂ compliance scenarios. The utility should provide its assessment of whether a CO ₂ regulatory future that is equally or more stringent than the identified trigger point will be mandated.	See Volume I, Chapter 8 (Modeling and Portfolio Selection Results), which includes a Trigger Point Analysis, summarizing portfolios developed with CO ₂ policy assumptions that are substantially different from the preferred portfolio.
8.d	Oregon compliance portfolio: If none of the above portfolios is consistent with Oregon energy policies (including state goals for reducing greenhouse gas emissions) as those policies are applied to the utility, the utility should construct the best cost/risk portfolio that achieves that consistency, present its cost and risk parameters, and compare it to those the preferred and alternative portfolios.	Two portfolios yield system emissions aligned with state goals for reducing greenhouse gas emissions. These cases are summarized in Volume I, Chapter 8 (Modeling and Portfolio Selection Results).
Guideline 9: Direct Access Loads		
9	An electric utility’s load-resource balance should exclude customer loads that are effectively committed to service by an	PacifiCorp continues to plan for load for direct access customers.

No.	Requirement	How the Guideline is Addressed in the 2015 IRP
	alternative electricity supplier.	
Guideline 10: Multi-state Utilities		
10	Multi-state utilities should plan their generation and transmission systems, or gas supply and delivery, on an integrated system basis that achieves a best cost/risk portfolio for all their retail customers.	The 2015 IRP conforms to the multi-state planning approach as stated in Volume I, Chapter 2 under the section “The Role of PacifiCorp’s Integrated Resource Planning”.
Guideline 11: Reliability		
11	Electric utilities should analyze reliability within the risk modeling of the actual portfolios being considered. Loss of load probability, expected planning reserve margin, and expected and worst-case unserved energy should be determined by year for top-performing portfolios. Natural gas utilities should analyze, on an integrated basis, gas supply, transportation, and storage, along with demand-side resources, to reliably meet peak, swing, and base-load system requirements. Electric and natural gas utility plans should demonstrate that the utility’s chosen portfolio achieves its stated reliability, cost and risk objectives.	See the response to 1.c.3.1 above. Volume I, Chapter 8 (Modeling and Portfolio Selection Results) walks through the role of reliability, cost, and risk measures in determining the preferred portfolio. Scatter plots of portfolio cost versus risk at for different price curve assumptions were used to inform the cost/risk tradeoff analysis. Stochastic and risk analysis results for specific portfolios are also included in Volume II Appendix L (Stochastic Production Costs Simulation Results).
Guideline 12: Distributed Generation		
12	Electric utilities should evaluate distributed generation technologies on par with other supply-side resources and should consider, and quantify where possible, the additional benefits of distributed generation.	PacifiCorp contracted with Navigant to provide estimates of expected distributed generation penetration. The study was incorporated in the analysis as a reduction to load. Sensitivities looked at both high and low penetration rates for distributed generation. The study is included in Volume II, Appendix O.
Guideline 13: Resource Acquisition		
13.a	An electric utility should, in its IRP: 1. Identify its proposed acquisition strategy for each resource in its action plan. 2. Assess the advantages and disadvantages of owning a resource instead of purchasing power from another party. 3. Identify any Benchmark Resources it plans to consider in competitive bidding.	Volume I, Chapter 9 (Action Plan and Resource Procurement) outlines the procurement approaches for resources identified in the preferred portfolio. A discussion of the advantages and disadvantages of owning a resource instead of purchasing it is included in Volume I, Chapter 9 (Action Plan and Resource Procurement). There are no Benchmark Resources in Chapter 9 (Action Plan and Resource Procurement).
13.b	For gas utilities only	Not applicable
Flexible Capacity Resources		
1	Forecast the Demand for Flexible Capacity: The electric utilities shall forecast the balancing reserves needed at different time intervals (e.g. ramping needed within 5 minutes) to respond to variation in load and intermittent renewable generation over the 20-year planning period.	See Volume II, Appendix F (Flexible Resource Needs Assessment).
2	Forecast the Supply of Flexible Capacity: The electric utilities shall forecast the balancing	See Volume II, Appendix F (Flexible Resource Needs Assessment).

No.	Requirement	How the Guideline is Addressed in the 2015 IRP
	reserves available at different time intervals (e.g. ramping available within 5 minutes) from existing generating resources over the 20-year planning period.	
3	Evaluate Flexible Resources on a Consistent and Comparable Basis: In planning to fill any gap between the demand and supply of flexible capacity, the electric utilities shall evaluate all resource options, including the use of EVs, on a consistent and comparable basis.	See Volume II, Appendix F (Flexible Resource Needs Assessment).

Table B.4 – Utah Public Service Commission IRP Standard and Guidelines

No.	Requirement	How the Standards and Guidelines are Addressed in the 2015 IRP
Procedural Issues		
1	The Commission has the legal authority to promulgate Standards and Guidelines for integrated resource planning.	Not addressed; this is a Public Service Commission of Utah responsibility.
2	Information Exchange is the most reasonable method for developing and implementing integrated resource planning in Utah.	Information exchange has been conducted throughout the IRP public input process.
3	Prudence reviews of new resource acquisitions will occur during ratemaking proceedings.	Not an IRP requirement as the Commission acknowledges that prudence reviews will occur during ratemaking proceedings, outside of the IRP process.
4	PacifiCorp's integrated resource planning process will be open to the public at all stages. The Commission, its staff, the Division, the Committee, appropriate Utah state agencies, and other interested parties can participate. The Commission will pursue a more active-directive role if deemed necessary, after formal review of the planning process.	PacifiCorp's public process is described in Volume I, Chapter 2 (Introduction). A record of public meetings is provided in Volume II, Appendix C (Public Input Process).
5	Consideration of environmental externalities and attendant costs must be included in the integrated resource planning analysis.	PacifiCorp used a scenario analysis approach, including scenarios addressing EPA's proposed 111(d) rule and additional scenarios that apply CO ₂ costs incremental to requirements in EPA's proposed 111(d) rule. See Volume I, Chapter 7 (Modeling and Portfolio Evaluation Approach) for a description of the methodology employed, including how CO ₂ policy uncertainty is factored into the portfolio development process.
6	The integrated resource plan must evaluate supply-side and demand-side resources on a consistent and comparable basis.	Supply, transmission, and demand-side resources were evaluated on a comparable basis using PacifiCorp's capacity expansion optimization model. Also see the response to number 4.b.ii below.
7	Avoided cost should be determined in a manner consistent with the Company's Integrated Resource Plan.	Consistent with the Utah rules, PacifiCorp determination of avoided costs in Utah is handled in a manner consistent with the IRP, updated with the most current information available.

No.	Requirement	How the Standards and Guidelines are Addressed in the 2015 IRP
8	The planning standards and guidelines must meet the needs of the Utah service area, but since coordination with other jurisdictions is important, must not ignore the rules governing the planning process already in place in other jurisdictions.	This IRP was developed in consultation with parties from all state jurisdictions, and meets all formal state IRP guidelines.
9	The Company's Strategic Business Plan must be directly related to its Integrated Resource Plan.	Volume I, Chapter 9 (Action Plan) describes the linkage between the 2015 IRP preferred portfolio, the 2013 IRP Update portfolio, and the fall 2014 ten-year business plan portfolio. The 2015 IRP preferred portfolio will serve as the starting point for the fall 2015 ten-year business plan resource assumptions, updated with more current information, as applicable.
Standards and Guidelines		
1	Definition: Integrated resource planning is a utility planning process which evaluates all known resources on a consistent and comparable basis, in order to meet current and future customer electric energy services needs at the lowest total cost to the utility and its customers, and in a manner consistent with the long-run public interest. The process should result in the selection of the optimal set of resources given the expected combination of costs, risk and uncertainty.	Volume I, Chapter 7 (Modeling and Portfolio Evaluation Approach) outlines the portfolio performance evaluation and preferred portfolio selection process, while Volume I, Chapter 8 (Modeling and Portfolio Selection Results) chronicles the modeling and preferred portfolio selection process. This IRP also addresses concerns expressed by Utah stakeholders and the Utah commission concerning comprehensiveness of resources considered, consistency in applying input assumptions for portfolio modeling, and explanation of PacifiCorp's decision process for selecting top-performing portfolios and the preferred portfolio.
2	The Company will submit its Integrated Resource Plan biennially.	The company submitted its last IRP on April 30, 2013, and filed this IRP on March 31, 2015 meeting the requirement.
3	IRP will be developed in consultation with the Commission, its staff, the Division of Public Utilities, the Committee of Consumer Services, appropriate Utah state agencies and interested parties. PacifiCorp will provide ample opportunity for public input and information exchange during the development of its Plan.	PacifiCorp's public process is described in Volume I, Chapter 2 (Introduction). A record of public meetings is provided in Volume II, Appendix C (Public Input Process).
4.a	PacifiCorp's integrated resource plans will include: a range of estimates or forecasts of load growth, including both capacity (kW) and energy (kWh) requirements.	PacifiCorp implemented a load forecast range for both capacity expansion optimization scenarios as well as for stochastic variability, covering both capacity and energy. Details concerning the load forecasts used in the 2015 IRP are provided in Volume I, Chapter 5 (Resource Needs Assessment) and Volume II, Appendix A (Load Forecast Details).
4.a.i	The forecasts will be made by jurisdiction and by general class and will differentiate energy and capacity requirements. The Company will include in its forecasts all on-system loads and those off-system loads which they have a contractual obligation to fulfill. Non-firm off-system sales are uncertain and should not be explicitly incorporated into the load forecast that the utility then plans to meet. However, the Plan must have some analysis of the off-system sales market to assess the impacts such markets will have on risks	Load forecasts are differentiated by jurisdiction and differentiate energy and capacity requirements. See Volume I, Chapter 5 (Resource Needs Assessment) and Volume II, Appendix A (Load Forecast Details). Non-firm off-system sales are not incorporated into the load forecast. Off-system sales markets are included in IRP modeling and are used for system balancing purposes.

No.	Requirement	How the Standards and Guidelines are Addressed in the 2015 IRP
	associated with different acquisition strategies.	
4.a.ii	Analyses of how various economic and demographic factors, including the prices of electricity and alternative energy sources, will affect the consumption of electric energy services, and how changes in the number, type and efficiency of end-uses will affect future loads.	Volume II, Appendix A (Load Forecast Details) documents how demographic and price factors are used in PacifiCorp’s load forecasting methodology.
4.b	An evaluation of all present and future resources, including future market opportunities (both demand-side and supply-side), on a consistent and comparable basis.	Resources were evaluated on a consistent and comparable basis using the System Optimizer model and Planning and Risk production cost model using both supply side and demand side alternatives. See explanation in Volume I, Chapter 7 (Modeling and Portfolio Evaluation Approach) and the results in Volume I, Chapter 8 (Modeling and Portfolio Selection Results). Resource options are summarized in Volume I, Chapter 6 (Resource Options).
4.b.i	An assessment of all technically feasible and cost-effective improvements in the efficient use of electricity, including load management and conservation.	PacifiCorp included supply curves for Class 1 DSM (dispatchable/schedulable load control) and Class 2 DSM (energy efficiency measures) in its capacity expansion model. Details are provided in Volume I, Chapter 6 (Resource Options). A sensitivity study of demand-response programs (Class 3 DSM) is described in Volume I, Chapter 7 (Modeling and Portfolio Evaluation Approach) with results reported in in Volume I, Chapter 8 (Modeling and Portfolio Selection Results).
4.b.ii	An assessment of all technically feasible generating technologies including: renewable resources, cogeneration, power purchases from other sources, and the construction of thermal resources.	PacifiCorp considered a wide range of resources including renewables, market purchases, thermal resources, energy storage, and Energy Gateway transmission configurations. Volume I, Chapters 6 (Resource Options) and 7 (Modeling and Portfolio Evaluation Approach) contain assumptions and describe the process under which PacifiCorp developed and assessed these technologies and resources.
4.b.iii	The resource assessments should include: life expectancy of the resources, the recognition of whether the resource is replacing/adding capacity or energy, dispatchability, lead-time requirements, flexibility, efficiency of the resource and opportunities for customer participation.	PacifiCorp captures and models these resources attributes in its IRP models. Resources are defined as providing capacity, energy, or both. The DSM supply curves used for portfolio modeling explicitly incorporate estimated rates of program and event participation. The distributed generation study produces penetration levels, modeled as a reduction to load, that considers rates of participation. Replacement capacity is considered in the case of assumed coal unit retirements as evaluated in this IRP. Dispatchability is accounted for in both IRP models; however, PaR model provides a more detailed representation of unit dispatch considering unit commitment and operating reserves not captured in System Optimizer.
4.c	An analysis of the role of competitive bidding for demand-side and supply-side resource	A description of the role of competitive bidding and other procurement methods is provided in Volume I,

No.	Requirement	How the Standards and Guidelines are Addressed in the 2015 IRP
	acquisitions	Chapter 9 (Action Plan and Resource Procurement).
4.d	A 20-year planning horizon.	This IRP uses a 20-year study horizon (2015-2034)
4.e	An action plan outlining the specific resource decisions intended to implement the integrated resource plan in a manner consistent with the Company's strategic business plan. The action plan will span a four-year horizon and will describe specific actions to be taken in the first two years and outline actions anticipated in the last two years. The action plan will include a status report of the specific actions contained in the previous action plan.	<p>The IRP action plan is provided in Volume I, Chapter 9 (Action Plan and Resource Procurement). A status report of the actions outlined in the previous action plan (2013 IRP update) is provided in Volume I, Chapter 9 (Action Plan and Resource Procurement).</p> <p>In Volume I, Chapter 9 (Action Plan and Resource Procurement) Table 9.1 identifies actions anticipated in the next two years and in the next four years.</p>
4.f	A plan of different resource acquisition paths for different economic circumstances with a decision mechanism to select among and modify these paths as the future unfolds.	Volume I, Chapter 9 (Action Plan and Resource Procurement) includes an acquisition path analysis that presents broad resource strategies based on trigger events such as changes in load growth, changes in environmental policies, and changes in market conditions.
4.g	An evaluation of the cost-effectiveness of the resource options from the perspectives of the utility and the different classes of ratepayers. In addition, a description of how social concerns might affect cost effectiveness estimates of resource options.	<p>PacifiCorp provides resource-specific utility and total resource cost information in Volume I, Chapter 6 (Resource Options).</p> <p>The IRP document addresses the impact of social concerns on resource cost-effectiveness in the following ways:</p> <ul style="list-style-type: none"> ● Portfolios were evaluated using a range of CO₂ compliance methods, most included emissions rate targets, but there was examination of additional CO₂ price adders. ● A discussion of environmental policy status and impacts on utility resource planning is provided in Volume I, Chapter 3 (The Planning Environment). ● State and proposed federal public policy preferences for clean energy are considered for development of the preferred portfolio, which is documented in Volume I, Chapter 8 (Modeling and Portfolio Selection Results). ● Volume II, Appendix G (Plant Water Consumption) of reports historical water consumption for PacifiCorp's thermal plants.
4.h	An evaluation of the financial, competitive, reliability, and operational risks associated with various resource options and how the action plan addresses these risks in the context of both the Business Plan and the 20-year Integrated Resource Plan. The Company will identify who should bear such risk, the ratepayer or the stockholder.	<p>The handling of resource risks is discussed in Volume I, Chapter 9 (Action Plan and Resource Procurement), and covers managing environmental risk for existing plants, risk management and hedging and treatment of customer and investment risk.</p> <p>Resource capital cost uncertainty and technological risk is addressed in Volume I, Chapter 6 (Resource Options).</p> <p>For reliability risks, the stochastic simulation model incorporates stochastic volatility of forced outages for new thermal plants and hydro availability. These</p>

No.	Requirement	How the Standards and Guidelines are Addressed in the 2015 IRP
		<p>risks are factored into the comparative evaluation of portfolios and the selection of the preferred portfolio upon which the action plan is based.</p> <p>Identification of the classes of risk and how these risks are allocated to ratepayers and investors is discussed in Volume I, Chapter 9 (Action Plan and Resource Procurement).</p>
4.i	Considerations permitting flexibility in the planning process so that the Company can take advantage of opportunities and can prevent the premature foreclosure of options.	Flexibility in the planning and procurement processes is highlighted in Volume I, Chapter 9 (Action Plan and Resource Procurement). Permitting activities related to Energy Gateway are described in Volume I, Chapter 4 (Transmission).
4.j	An analysis of tradeoffs; for example, between such conditions of service as reliability and dispatchability and the acquisition of lowest cost resources.	PacifiCorp examined the trade-off between portfolio cost and risk, taking into consideration a broad range of resource alternatives defined with varying levels of dispatchability. This trade-off analysis is documented in Volume I, Chapter 8 (Modeling and Portfolio Selection Results), and highlighted through the use of scatter-plot graphs showing the relationship between stochastic mean and upper-tail mean stochastic PVRR.
4.k	A range, rather than attempts at precise quantification, of estimated external costs which may be intangible, in order to show how explicit consideration of them might affect selection of resource options. The Company will attempt to quantify the magnitude of the externalities, for example, in terms of the amount of emissions released and dollar estimates of the costs of such externalities.	PacifiCorp incorporated environmental externality costs for CO ₂ and costs for complying with current and proposed U.S. EPA regulatory requirements. For CO ₂ externality costs, the company used scenarios with various compliance requirements to capture a reasonable range of cost impacts. These modeling assumptions are described in Volume I, Chapter 7 (Modeling and Portfolio Evaluation Approach). Results are documented in Volume I, Chapter 8 (Modeling and Portfolio Selection Results).
4.l	A narrative describing how current rate design is consistent with the Company's integrated resource planning goals and how changes in rate design might facilitate integrated resource planning objectives.	See Volume I, Chapter 3 (The Planning Environment). The role of Class 3 DSM (price response programs) at PacifiCorp and how these resources are modeled in the IRP are described in Volume I, Chapter 6 (Resource Options).
5	PacifiCorp will submit its IRP for public comment, review and acknowledgment.	<p>PacifiCorp distributed draft IRP materials for external review throughout the process prior to each of the public input meetings and solicited/and received feedback while developing the 2015 IRP. The materials shared with stakeholders at these meetings, outlined in Volume I Chapter 2 (Introduction), is consistent with materials presented in Volumes I, II, and III of the 2015 IRP report.</p> <p>PacifiCorp requested and responded to comments from stakeholders in developing core case and sensitivity definitions. The Company considered comments received via the Feedback Form in developing its final plan.</p>
6	The public, state agencies and other interested parties will have the opportunity to make formal	Not addressed; this is a post-filing activity.

No.	Requirement	How the Standards and Guidelines are Addressed in the 2015 IRP
	comment to the Commission on the adequacy of the Plan. The Commission will review the Plan for adherence to the principles stated herein, and will judge the merit and applicability of the public comment. If the Plan needs further work the Commission will return it to the Company with comments and suggestions for change. This process should lead more quickly to the Commission's acknowledgment of an acceptable Integrated Resource Plan. The Company will give an oral presentation of its report to the Commission and all interested public parties. Formal hearings on the acknowledgment of the Integrated Resource Plan might be appropriate but are not required.	
7	Acknowledgment of an acceptable Plan will not guarantee favorable ratemaking treatment of future resource acquisitions.	Not addressed; this is not a PacifiCorp activity.
8	The Integrated Resource Plan will be used in rate cases to evaluate the performance of the utility and to review avoided cost calculations.	Not addressed; this refers to a post-filing activity.

Table B.5 – Washington Utilities and Transportation Commission IRP Standard and Guidelines (RCW 19.280.030 and WAC 480-100-238)

No.	Requirement	How the Standards and Guidelines are Addressed in the 2015 IRP
Requirements prior to IRP Filing		
(4)	Work plan filed no later than 12 months before next IRP due date.	PacifiCorp filed the IRP work plan on March 31, 2014 in Docket No. UE-140546, given an anticipated IRP filing date of March 31, 2015.
(4)	Work plan outlines content of IRP.	See pages 1-2 of the Work Plan document for a summary of IRP contents.
(4)	Work plan outlines method for assessing potential resources. (See LRC analysis below)	See pages 3-5 of the Work Plan document for a summary of resource analysis.
(5)	Work plan outlines timing and extent of public participation.	See pages 5-6 of the Work Plan. Figure 2, page 6, document for the IRP schedule.
(4)	Integrated resource plan submitted within two years of previous plan.	The Commission issued an Order on December 11, 2008, under Docket no. UE-070117, granting the Company permission to file its IRP on March 31 of each odd numbered year. PacifiCorp filed the 2015 IRP on March 31, 2015 within two years of the 2013 IRP filed on April 30, 2013.
(5)	Commission issues notice of public hearing after company files plan for review.	This activity is conducted subsequent to filing this IRP.
(5)	Commission holds public hearing.	This activity is conducted subsequent to filing this IRP.
Requirements specific to IRP filing		
(2)(a)	Plan describes the mix of energy supply resources.	Volume I, Chapter 5 (Resource Need Assessment) describes the mix of existing resources, while Volume I, Chapter 8 (Modeling and Portfolio Selection Results) describes the 2015 IRP preferred portfolio.
(2)(a)	Plan describes conservation supply.	See Volume I, Chapter 6 (Resource Options) for a description of how conservation supplies are represented and modeled, and

No.	Requirement	How the Standards and Guidelines are Addressed in the 2015 IRP
		Volume I, Chapter 8 (Modeling and Portfolio Selection Results) for conservation supply in the preferred portfolio. Additional information on energy efficiency resource characteristics is available in Appendix D.
(2)(a)	Plan addresses supply in terms of current and future needs at the lowest reasonable cost to the utility and its ratepayers.	The 2015 IRP preferred portfolio was based on a resource needs assessment that accounted for forecasted load growth, expiration of existing power purchase contracts, resources under construction, contract, as well as a capacity planning reserve margin. Details on PacifiCorp’s findings of resource need are described in Volume I, Chapter 5 (Resource Needs and Assessment).
(2)(b)	Plan uses lowest reasonable cost (LRC) analysis to select the mix of resources.	PacifiCorp uses portfolio performance measures based on the Present Value of Revenue Requirements (PVRR) methodology. See the section on portfolio performance measures in Volume I, Chapter 7 (Modeling and Portfolio Evaluation Approach) and Volume I Chapter 8 (Modeling and Portfolio Selection Results).
(2)(b)	LRC analysis considers resource costs.	Volume I, Chapter 6 (Resource Options), provides detailed information on costs and other attributes for all resources analyzed for the IRP.
(2)(b)	LRC analysis considers market-volatility risks.	PacifiCorp employs Monte Carlo production cost simulation with a stochastic model to characterize market price and gas price volatility. Volume I, Chapter 7 (Modeling and Portfolio Evaluation Approach) provides a summary of the modeling approach.
(2)(b)	LRC analysis considers demand side resource uncertainties.	PacifiCorp captured demand-side resource uncertainties through the development of numerous portfolios based on different sets of input assumptions.
(2)(b)	LRC analysis considers resource dispatchability.	PacifiCorp uses two IRP models that simulate the dispatch of existing and future resources based on such attributes as heat rate, availability, fuel cost, and variable O&M cost. The chronological production cost simulation model also incorporates unit commitment logic for handling start-up, shutdown, ramp rates, minimum up/down times, and run up rates, and reserve holding characteristics of individual generators.
(2)(b)	LRC analysis considers resource effect on system operation.	PacifiCorp’s IRP models simulate the operation of its entire system, reflecting dispatch/unit commitment, forced/unforced outages, access to markets, and system reliability and transmission constraints.
(2)(b)	LRC analysis considers risks imposed on ratepayers.	<p>PacifiCorp explicitly models risk associated with uncertain CO₂ regulatory regimes, wholesale electricity and natural gas price escalation and volatility, load growth uncertainty, resource reliability, renewable portfolio standard requirement uncertainty, plant construction cost escalation, and resource affordability. These risks and uncertainties are handled through stochastic modeling and scenarios depicting alternative futures.</p> <p>In addition to risk modeling, the IRP discusses a number of resource risk topics not addressed in the IRP system simulation models. For example, Volume I, Chapter 9 (Action Plan and Resource Procurement) covers the following topics: (1) managing carbon risk for existing plants, (2) assessment of owning vs. purchasing power, (3) purpose of hedging, (4) procurement delays and (5) treatment of customer and investor risks. Volume I, Chapter 4 (Transmission) covers similar risks associated with transmission system expansion.</p>
(2)(b)	LRC analysis considers public policies regarding resource preference adopted by Washington state or federal government.	In Volume I, Chapter 7 (Modeling and Portfolio Evaluation) the IRP modeling incorporates resource expansion constraints tied to renewable portfolio standards (RPS) currently in place for Washington. PacifiCorp also evaluated various CO ₂ regulatory

No.	Requirement	How the Standards and Guidelines are Addressed in the 2015 IRP
		schemes, and future Regional Haze compliance requirements. The I-937 conservation requirements are also explicitly accounted for in developing Washington conservation resource costs.
(2)(b)	LRC analysis considers cost of risks associated with environmental effects including emissions of carbon dioxide.	See (2)(b) above. PacifiCorp includes in Volume I, Chapter 8 (Modeling and Portfolio Selection Results) portfolios that meet Washington’s goal of reducing emissions to 1990 levels by 2020.
(2)(c)	Plan defines conservation as any reduction in electric power consumption that results from increases in the efficiency of energy use, production, or distribution.	A description of how PacifiCorp classifies and defines energy conservation is provided in Volume I, Chapter 6 (Resource Options).
(3)(a)	Plan includes a range of forecasts of future demand.	PacifiCorp implemented a load forecast range. Details concerning the load forecasts used in the 2015 IRP (high, low, and extreme peak temperature) are provided in Volume I, Chapters 5 (Resource Needs Assessment) and Volume II, Appendix A (Load Forecast Details).
(3)(a)	Plan develops forecasts using methods that examine the effect of economic forces on the consumption of electricity.	PacifiCorp’s load forecast methodology employs econometric forecasting techniques that include such economic variables as household income, employment, and population. See Volume II, Appendix A (Load Forecast Details) for a description of the load forecasting methodology.
(3)(a)	Plan develops forecasts using methods that address changes in the number, type and efficiency of electrical end-uses.	Residential sector load forecasts use a statistically-adjusted end-use model that accounts for equipment saturation rates and efficiency. See Volume II, Appendix A (Load Forecast Details), for a description of the residential sector load forecasting methodology.
(3)(b)	Plan includes an assessment of commercially available conservation, including load management.	PacifiCorp updated its conservation potential assessment (CPA) in support of the 2015 IRP, which served as the basis for developing DSM resource supply curves for resource portfolio modeling. The supply curves account for technical and achievable (market) potential, while the IRP capacity expansion model identifies a cost-effective mix of DSM resources based on these limits and other model inputs. The DSM potentials study is included on the data disk, and available on PacifiCorp’s IRP website.
(3)(b)	Plan includes an assessment of currently employed and new policies and programs needed to obtain the conservation improvements.	A description of the current status of DSM programs and on-going activities to implement current and new programs is provided in Volume I, Chapter 5 (Resource Needs Assessment).
(3)(c)	Plan includes an assessment of a wide range of conventional and commercially available nonconventional generating technologies.	PacifiCorp considered a wide range of resources including renewables, market purchases, thermal resources, energy storage, and transmission. Volume I, Chapters 6 (Resource Options and Chapter 7 (Modeling and Portfolio Evaluation Approach) document how PacifiCorp developed and assessed these technologies.
(3)(d)	Plan includes an assessment of transmission system capability and reliability; to the extent such information can be provided consistent with applicable laws.	PacifiCorp modeled transmission system capability to serve its load obligations, factoring in updates to the representation of major load and generation centers, regional transmission congestion impacts, import/export availability, external market dynamics, and significant transmission expansion plans explained in Volume I, Chapter 4 (Transmission) and Chapter 7 (Modeling and Portfolio Evaluation Approach). System reliability given transmission capability was analyzed using stochastic production cost simulation and measures of insufficient energy and capacity for a load area (Energy Not Served and Unmet Capacity, respectively).

No.	Requirement	How the Standards and Guidelines are Addressed in the 2015 IRP
(3)(e)	Plan includes a comparative evaluation of energy supply resources (including transmission and distribution) and improvements in conservation using LRC.	PacifiCorp’s capacity expansion optimization model (System Optimizer) is designed to compare alternative resources for the least-cost resource mix. System Optimizer was used to develop numerous resource portfolios for comparative evaluation on the basis of cost, risk, reliability, and other performance attributes. Potential energy savings associated with conservation voltage reduction are discussed in Volume I, Chapter 5 (Resource Needs Assessment).
(3)(f)	Plan includes integration of the demand forecasts and resource evaluations into a long range integrated resource plan describing the mix of resources that is designated to meet current and project future needs at the lowest reasonable cost to the utility and its ratepayers.	PacifiCorp integrates demand forecasts, resources, and system operations in the context of a system modeling framework described in Volume I, Chapter 7 (Modeling and Portfolio Evaluation Approach). The portfolio evaluation covers a 20-year period (2015-2034). PacifiCorp developed its preferred portfolio of resources judged to be least-cost after considering load requirements, risk, uncertainty, supply adequacy/reliability, and government resource policies in accordance with this rule.
(3)(g)	Plan includes a two-year action plan that implements the long range plan.	See Table 9.1 in Volume I, Chapter 9 (Action Plan and Resource Procurement), for PacifiCorp’s 2015 IRP action plan.
(3)(h)	Plan includes a progress report on the implementation of the previously filed plan.	See Table 9.2 for a status report on action plan implementation in Volume I, Chapter 9 (Action Plan and Resource Procurement).
Requirements from RCW 19.280.030 not discussed above		
(1)(e)	An assessment of methods, commercially available technologies, or facilities for integrating renewable resources, and addressing overgeneration events, if applicable to the utility’s resource portfolio;	Volume I, Chapter 6 for discussion of options available for selection in the 2015 IRP. Also see Volume II, Appendix H for PacifiCorp’s Wind Integration Study,
(1)(f)	The integration of the demand forecasts and resource evaluations into a long-range assessment describing the mix of supply side generating resources and conservation and efficiency resources that will meet current and projected needs, including mitigating overgeneration events, at the lowest reasonable cost and risk to the utility and its ratepayers; and	See Volume II, Appendix A for a discussion of the load forecasts, Supply-side and demand-side are discussed in Volume I, Chapter 6. DSM resources are discussed in Volume II, Appendix D. Volume I, Chapters 8 (Modeling and Portfolio Selection Results) describes how preferred portfolio resources meet capacity and energy needs. Appendix F summarizes a flexible resource needs assessment based on the preferred portfolio.

Table B.6 – Wyoming Public Service Commission IRP Standard and Guidelines (Docket 90000-107-XO-09)

No.	Requirement	How the Guideline is Addressed in the 2015 IRP
A	The public comment process employed as part of the formulation of the utility’s IRP, including a description, timing and weight given to the public process;	PacifiCorp’s public process is described in Volume I, Chapter 2 (Introduction) and in Volume II, Appendix C (Public Input Process).
B	The utility’s strategic goals and resource planning goals and preferred resource portfolio;	Volume I, Chapter 8 (Modeling and Portfolio Selection Results) documents the preferred resource portfolio and rationale for selection. Volume I, Chapter 9 (Action Plan and Resource Procurement) constitutes the IRP action plan and the descriptions of resource strategies and risk management.
C	The utility’s illustration of resource need over the near-term and long-	See Volume I, Chapter 5 (Resource Needs Assessment).

No.	Requirement	How the Guideline is Addressed in the 2015 IRP
	term planning horizons;	
D	A study detailing the types of resources considered;	Volume, I Chapter 6 (Resource Options), presents the resource options used for resource portfolio modeling for this IRP.
F	Changes in expected resource acquisitions and load growth from that presented in the utility's previous IRP;	A comparison of resource changes relative to the 2013 IRP Update is presented in Volume I, Chapter 9 (Action Plan and Resource Procurement). A chart comparing the peak load forecasts for the 2013 IRP, 2013 IRP Update, and 2015 IRP is included in Volume II, Appendix A (Load Forecast Details).
G	The environmental impacts considered;	Portfolio comparisons for CO ₂ and a broad range of environmental impacts are considered. See Volume I, Chapter 7 (Modeling and Portfolio Evaluation Approach) and Chapter 8 (Modeling and Portfolio Selection Results) as well as Volume II, Appendix L (Stochastic and Production Cost Simulation Results).
H	Market purchases evaluation;	Modeling of firm market purchases (front office transactions) and spot market balancing transactions is included in this IRP. See also Volume II Appendix J for the Western Resource Adequacy Evaluation.
I	Reserve Margin analysis; and	PacifiCorp's planning reserve margin study, which documents selection of a capacity planning reserve margin is in Volume I, Appendix I (Planning Reserve Margin Study).
J	Demand-side management and conservation options;	See Volume I, Chapter 6 (Resource Options) for a detailed discussion on DSM and conservation resource options. Additional information on energy efficiency resource characteristics is available in Appendix D.

APPENDIX C – PUBLIC INPUT PROCESS

A critical element of this Integrated Resource Plan (IRP) is the public input process. PacifiCorp has pursued an open and collaborative approach involving the Commissions, customers and other stakeholders in PacifiCorp's IRP prior to making resource planning decisions. Since these decisions can have significant economic and environmental consequences, conducting the IRP with transparency and full participation from interested and affected parties is essential.

Stakeholders have been involved in the IRP from the beginning. In fact, public input was solicited starting immediately following the conclusion of the 2013 IRP. A meeting was held on September 23, 2013 to discuss potential improvements to the IRP process; written comments were requested as well. Comments from participants helped shape 2015 IRP process improvements. Some examples of process improvements include the scheduling of multiple-day public input meetings to ensure sufficient time to cover agenda items in depth, use of a feedback form, providing opportunities for stakeholders to submit written comments at any point during the public input process, and the inclusion of data disks submitted with this filing.

The public input meetings (PIM) held beginning in June 2014 were the cornerstone of the direct public input process. There were a total of seven PIMs, with four lasting two days, the remainder being single days. Meetings were held jointly in both Salt Lake City, Utah and Portland, Oregon via video conference. Attendees off-site were able to conference in via phone.

The IRP public process also included state-specific stakeholder dialogue sessions held in June 2014. The goal of these sessions was to capture key IRP issues of most concern to each state and to discuss how a state's concerns might be addressed from a system planning perspective. PacifiCorp also wanted to ensure that stakeholders understood IRP planning principles. These meetings continued to enhance interaction with stakeholders in the planning cycle, and provided a forum to directly address stakeholder concerns regarding equitable representation of state interests during general public meetings.

PacifiCorp solicited agenda item recommendations from the state stakeholders in advance of the state meetings. There was additional open time to ensure that participants had adequate opportunity to discuss any topic of interest. Some follow-up activities arising from the sessions were addressed in subsequent public meetings.

PacifiCorp's comment website housed the Feedback form discussed earlier. This standardized form allowed stakeholders opportunities to provide comments, questions, and suggestions.

Comments are posted on the following link:

(<http://www.pacificorp.com/es/irp/irpcomments.html>).

Participant List

PacifiCorp's 2015 IRP public process was robust, involving input from many parties throughout. Organizations actively participated in the development of material, modeling process, and public meetings. Participants included commissioners, commission staff, stakeholders, and industry experts. The following organizations were represented and actively involved in this collaborative effort:

Commissions and/or Commission Staff

Idaho Public Utilities Commission
Oregon Public Utilities Commission
Public Service Commission of Utah
Washington Utilities and Transportation Commission
Wyoming Public Service Commission

Stakeholders and Industry Experts

ABB Enterprise Software Inc. (formerly known as Ventyx Inc.)
Apex Clean Energy
Applied Energy Group
Avista Utilities
Black & Veatch
Blue Castle Holdings, Inc.
Citizen's Utility Board of Oregon
EDF-Renewable Energy
Energy Trust of Oregon
E-Quant Consulting
First Wind
GE Energy
Harris Group Inc.
HDR Engineering
Health Environment Alliance of Utah
Horizon Wind Energy
Idaho Conservation League
Idaho Power Company
Individual Customers
Industrial Customers of Northwest Utilities
Interwest Energy Alliance
Kennecott Utah Copper
Magnum Energy
Mitsubishi
Monsanto Company
Mormon Environmental Stewardship Alliance
National Parks Conservation Association
National Renewable Energy Laboratory
Navigant Consulting, Inc.
Northwest Power and Conservation Council
Northern Laramie Range Alliance
Northwest Pipeline GP
NW Energy Coalition
Oregon Department of Energy
Oregon Department of Environmental Quality
Erin O'Neill (Independent Consultant)
Portland General Electric
Powder River Basin Resource Council
Renewable Energy Coalition

Renewables Northwest
Sargent & Lundy
Sierra Club
Siemens
SolarCity
Southwest Energy Efficiency Project
Sugar House Community Council
Synapse Energy Economics
University of Utah
For Utah Association of Energy Users
Utah Associated Municipal Power Systems
Utah Clean Energy
Utah Division of Public Utilities
Utah Industrial Energy Consumers
Utah Municipal Power Agency
Utah Office of Consumer Services
Utah Office of Energy Development
Utah Physicians for a Healthy Environment
Wartsila
Western Clean Energy Campaign
Western Electricity Coordination Council
Western Resource Advocates
West Wind Wires
Wyoming Industrial Energy Consumers
Wyoming Office Of Consumer Advocate

PacifiCorp extends its gratitude for the time and energy these participants have given to the IRP. Their participation has contributed significantly to the quality of this plan, and their continued participation will help PacifiCorp as it strives to improve its planning efforts going forward.

Public Input Meetings

As mentioned above, PacifiCorp hosted seven public input meetings, as well as five state meetings during the public process. The Company also held confidential workshops in Portland and Salt Lake City to review the Company's 111(d) Scenario Maker spreadsheet-based modeling tool developed to analyze EPA's proposed rule under §111(d) of the Clean Air Act.⁶ During the 2015 IRP public process, presentations and discussions covered various issues regarding model input assumptions, risks, modeling techniques, and analytical results. Below are the agendas from the public input meetings and the technical workshops; the presentations, and materials may be found on the data disks provided.

General Meetings

June 5, 2014 – General Public Meeting

- Introductions
- 2015 IRP Schedule

⁶ Also known as the Clean Power Plan, as proposed by the Environmental Protection Agency, June 2, 2014.

- Process Improvements
- 2013 IRP Update Highlights
- 2013 IRP Requirements
- Action Plan status updates

July 17-18, 2014 – General Public Meeting

Day 1

- Introductions
- Environmental Policy
- Renewable Portfolio Standards
- Transmission
- Portfolio Development

Day 2

- Sensitivities and Risk Analysis Process
- DSM Potential Study
- Load Forecast

August 7-8, 2014 – General Public Meeting

Day 1

- Introductions
- Supply-Side Resources
 - Includes Energy Storage Study
- Needs Assessment
- Distributed Generation Study
- Plant Efficiency Study

Day 2

- Portfolio Development
- Wind Integration
- Planning Reserve Margin
- Wind & Solar Capacity Contribution Discussion on Volume 3

September 25-26, 2014 – General Public Meeting

Day 1

- Introductions
- Stochastic Modeling & Portfolio Selection Process
- Portfolio Development Cases
- Smart Grid Update
- Conservation Voltage Reduction

Day 2

- Anaerobic Digester Study
- Modeling for Confidential Volume III
- Planning Reserve Margin Results
- Resource Capacity Contribution Results
- Wind Integration Cost Results

November 14, 2014 – General Public Meeting

- Introductions
- Energy Imbalance Market (EIM) Update
- Price Curve Scenarios
- Portfolio Development Draft Results
- Portfolio Development Draft Results

December 8, 2014 – Confidential Technical Workshop (Salt Lake City)

- 111(d) Scenario Maker

December 10, 2014 – Confidential Technical Workshop (Portland)

- 111(d) Scenario Maker

January 29-30, 2015 – General Public Meeting

- Confidential Coal Analysis
- Preferred Portfolio Overview
- PaR Modeling Update
- Preferred Portfolio Selection
- Sensitivity Studies

February 26, 2015 – General Public Meeting

- 2015 IRP Draft Action Plan
- High CO₂ PaR Results
- Sensitivity Studies
- Wrap-up Discussion

State Meetings

June 10, 2014 – Washington State Stakeholder Meeting

June 17, 2014 – Idaho State Stakeholder Meeting

June 18, 2014 – Utah State Stakeholder Meeting

June 19, 2014 – Wyoming State Stakeholder Meeting

June 26, 2014 – Oregon State Stakeholder Meeting

Stakeholder Comments

For the 2015 IRP, PacifiCorp introduced a feedback form which offered stakeholders a direct opportunity to provide comments, questions, and suggestions outside the PIMs. PacifiCorp recognizes the importance of stakeholder feedback to the IRP public input process. A blank form, as well as those submitted by stakeholders, is housed on the PacifiCorp website at IRP comments webpage at: <http://www.pacificorp.com/es/irp/irpcomments.html>

The form itself allowed the Company to easily review and summarize issues by topic as well as identify specific recommendations that were provided. Information collected was used to inform assumptions and modeling efforts in the 2015 IRP. Comment forms were received from the following stakeholders:

- Blue Castle Holdings
- Citizens' Utility Board of Oregon
- Clean Energy Scenario Stakeholders
- HEAL Utah
- Idaho Conservation League
- Industrial Customers of Northwest Utilities
- Interwest Energy Alliance
- Individual Customer
- Mormon Environmental Stewardship Alliance
- Northern Laramie Range Alliance (NLRA)
- NW Energy Coalition
- Oregon Department of Energy (ODOE)
- Oregon Public Utility Commission
- Powder River Basin Resource Council
- Renewable Energy Coalition
- Renewable Northwest
- Sierra Club
- Southwest Energy Efficiency Project (SWEEP)
- Utah Association of Energy Users
- Utah Clean Energy
- Utah Clean Energy with WRA and SWEEP
- Utah Division of Public Utilities
- Utah Office of Consumer Services
- Washington Department of Commerce
- Washington Utilities and Transportation Commission
- Western Clean Energy Campaign
- Western Resource Advocates (WRA)

Some topics of note addressed in the forms include:

- Application of EPA's proposed 111(d) rule
- Resource cost and performance assumptions (solar/wind/nuclear)
- Demand side management
- Allocation of RPS costs
- Modeling questions
- Anaerobic digester study
- Load forecast
- Renewable capacity values
- Transmission
- EPA BART timing for Utah
- Wholesale power availability
- Additional CO₂ costs
- Specific sensitivity case recommendations

Contact Information

PacifiCorp's IRP internet website contains many of the documents and presentations that support recent Integrated Resource Plans. To access these materials, please visit the Company's IRP website at <http://www.pacificorp.com/es/irp.html>.

PacifiCorp requests that any informal request be sent in writing to the following address or email address below.

PacifiCorp
IRP Resource Planning Department
825 N.E. Multnomah, Suite 600
Portland, Oregon 97232

Electronic Email Address:
IRP@PacifiCorp.com

Phone Number:
(503) 813-5245

APPENDIX D – DEMAND-SIDE MANAGEMENT RESOURCES

Introduction

Appendix D reviews the studies and reports used to support the demand-side management (DSM) resource information used in the modeling and analysis of the 2015 Integrated Resource Plan (IRP). In addition, it provides information on the economic DSM selections in the 2015 IRP's Preferred Portfolio, a summary of existing DSM program services and offerings, the preliminary budgets to acquire the resources and the State specific implementation actions, including communications and outreach activity, the Company intends to pursue in the acquisition of those resources.

Demand-Side Resource Potential Assessments for 2015-2034

Since 1989, PacifiCorp has developed biennial IRPs to identify an optimal mix of resources that balance considerations of cost, risk, uncertainty, supply reliability/deliverability, and long-run public policy goals. The optimization process accounts for capital, energy, and ongoing operation costs as well as the risk profiles of various resource alternatives, including: traditional generation and market purchases, renewable generation, and DSM resources such as energy efficiency, and demand response or capacity-focused resources. Since the 2008 IRP, DSM resources have competed directly against supply-side options, allowing the IRP model to guide decisions regarding resource mixes, based on cost and risk.

This study, conducted by Applied Energy Group (AEG), primarily seeks to develop reliable estimates of the magnitude, timing, and costs of DSM resources likely available to PacifiCorp over a 20-year planning horizon, beginning in 2015. The study focuses on resources realistically achievable during the planning horizon, given normal market dynamics that may hinder resource acquisition. Study results were incorporated into PacifiCorp's 2015 IRP and will be used to inform subsequent DSM planning and program design efforts. This study serves as an update of similar studies completed in 2007, 2011 and 2013.

For resource planning purposes, PacifiCorp classifies DSM resources into four classifications, differentiated by two primary characteristics: reliability and customer choice. These resources classifications can be defined as: Class 1 DSM (firm, capacity focused), Class 2 DSM (energy efficiency), Class 3 DSM (non-firm, capacity focused), and Class 4 DSM (educational).

From a system-planning perspective, Class 1 DSM resources can be considered the most reliable, as they can be dispatched by the utility. In contrast, behavioral changes, resulting from voluntary educational programs included in Class 4 DSM, tend to be the least reliable. With respect to customer choice, Class 1 DSM and Class 2 DSM resources should be considered involuntary in that, once equipment and systems have been put in place, savings can be expected to flow. Class 3 and Class 4 DSM activities involve greater customer choice and control. This assessment estimates potential from Class 1, 2, and 3 DSM.

This study excludes an assessment of Oregon’s Class 2 DSM resource potential, as this work has been captured in an assessment commissioned by the Energy Trust, which provides energy-efficiency potential in Oregon to PacifiCorp for resource planning purposes.

PacifiCorp’s Demand-Side Resource Potential Assessment for 2015-2034, completed by AEG, can be found at:

<http://www.pacificorp.com/es/dsm.html>

Energy Trust of Oregon’s Energy Efficiency Resource Assessment Report, completed by Navigant Consulting, can be found at:

<http://energytrust.org/About/policy-and-reports/Reports.aspx>

DSM – Economic Class 2 DSM Resource Selections – Preferred Portfolio

The following table shows the economic selections by state and year of the Class 2 DSM resources in the 2015 IRP preferred portfolio, C05a-3Q.

Energy Efficiency Energy (MWh) Selected by State and Year										
State	2015	2016	2017	2018	2019	2020	2021	2022	2023	2024
CA	6,390	7,500	8,580	9,670	10,500	6,430	6,800	7,100	7,460	7,140
OR	191,240	168,400	154,140	140,780	124,750	116,150	105,880	104,610	99,210	97,320
WA	37,880	41,200	44,600	44,260	48,610	38,230	40,240	41,910	44,270	43,740
UT	264,360	303,040	333,400	351,640	381,660	329,310	345,410	368,050	371,170	381,920
ID	13,570	15,800	17,570	19,170	20,920	15,910	16,750	17,680	18,550	19,200
WY	37,770	48,180	57,590	68,550	79,170	71,430	75,910	82,380	86,220	89,830
Total System	551,210	584,120	615,880	634,070	665,610	577,460	590,990	621,730	626,880	639,150

Energy Efficiency Energy (MWh) Selected by State and Year										
State	2025	2026	2027	2028	2029	2030	2031	2032	2033	2034
CA	6,010	6,260	6,400	6,380	6,300	5,800	5,760	5,550	5,580	5,350
OR	87,980	90,980	89,180	89,080	86,480	87,560	84,080	86,820	82,200	81,260
WA	36,040	35,530	35,130	35,810	34,900	31,190	30,960	30,500	30,400	29,560
UT	309,050	308,630	313,970	312,190	300,950	280,910	277,410	274,700	271,590	268,920
ID	18,050	18,110	17,980	17,850	17,290	15,830	16,220	15,840	15,940	14,920
WY	72,180	75,080	77,150	84,910	84,410	85,120	89,910	92,620	93,560	96,090
Total System	529,310	534,590	539,810	546,220	530,330	506,410	504,340	506,030	499,270	496,100

For the 20-year assumed nameplate capacity contributions (MW impacts) by state and year associated with the Class 2 DSM resource selections above see Table 8.7 – PacifiCorp’s 2015 IRP Preferred Portfolio, in Volume I of the 2015 IRP.

DSM – State Implementation Plans

Background

The Public Utility Commission of Oregon acknowledged PacifiCorp’s 2013 Integrated Resource Plan with exceptions and revisions in Order No. 14-252, entered on July 8, 2014. Appendix A – Adopted Recommendations of the Order states the Company must “Include a PacifiCorp service area specific implementation plan as part of the 2015 IRP filing.” The Order further states that “At twice yearly updates to the Commission, [the Company must] provide a summary of savings potential, gaps and how PacifiCorp specific implementation plan and programs are achieving the identified potential.” This document serves to comply with the implementation plan requirement

by providing DSM state acquisition selections, preliminary budgets, program overviews, and major actions planned for calendar years 2015-2018.

DSM Resource Selections

Class 1 DSM resources (dispatchable or scheduled firm capacity resources)

As a result of the Company's resource position and favorable cost resource cost alternatives, no incremental additions to the Company's Class 1 DSM resources were selected within the 2015-2018 implementation plan window. Incremental Class 1 DSM selections begin in 2022 with the selection of 5 megawatts (MW) of Oregon irrigation load control. In total, 41.7 MWs of incremental Class 1 DSM resources were selected over the 20 year planning horizon. Selections by State, Product, and Year are provided in Table D.1 for informational purposes only.

Table D.1 – Incremental and Cumulative Class 1 Resource Selections by State, Product and Year

State/Product by Year	2022	2023	2026	2029	2033	Total/Products (MW)
Oregon Irrigation Load Control	5					5
Oregon Curtailment Agreements		10.6	10.6	10.6		31.8
Utah Res. Load Control Cooling					4.9	4.9
Cumulative Total by Year (MW)	5	15.6	26.2	36.8	41.7	41.7

In preparation for the 2022 west-side capacity requirement, near-term Class 1 DSM efforts will focus on a Company proposal of an Oregon and California irrigation load control program pilot (Klamath Basin) in order to 1) test the effectiveness of the Company's Idaho and Utah program design in smaller markets, and 2) given the differences in grower operations in the west to better understand west-side irrigation customers capabilities and challenges in participating in load management programs. The load control pilot will complement the Company's Oregon and proposed California time-of-use pilots and provide growers a second alternative to manage their peak usage and save money. The Company will also seek further refinements to its existing Class 1 DSM products in Utah and Idaho, seeking to identify additional operational improvements and integration of dispatch strategies in order to maximize resource value and effectiveness. Table D.2 provides a summary of the Company's *existing* Class 1 DSM resources relied upon in the development of the 2015 Integrated Resource Plan's load resource balance position.

Table D.2 – Existing Class 1 DSM resources (2015 Preferred Portfolio)

State/Product by Year	2015	2016	2017	2018
Idaho				
<i>Irrigation DLC</i>	170	170	170	170
Utah				
<i>Residential DLC</i>	115	115	115	115
<i>Irrigation DLC</i>	20	20	20	20
Idaho and Utah				
<i>Special Contract Load⁷</i>	149	175	175	175
Total (MW)	454	480	480	480

Class 2 DSM Resources (energy efficiency)

The acquisition of Class 2 DSM resources continues to be the largest demand-side resource in the 2015 IRP, contributing 2,385 gigawatt hours (GWh) of cost-effective energy savings by

⁷ The projected increase in Special Contract Load under management in 2016 is result of expected agreement renegotiation, not due to 2015 IRP model selections. The resources are classified as "existing" rather than "new" for purposes of resource planning.

2018; maximum demand reduction of 565 MW⁸. By 2018, Class 2 DSM selections in the 2015 IRP Preferred Portfolio exceed those in the 2013 IRP by 37 percent. Initial analysis indicates changing market assumptions and measure costs coupled with increased resource opportunities in lighting, space conditioning, water heating, appliances and industrial process end-uses (both capital and non-capital) are responsible for the majority of the increase in economic resource selections⁹. Table D.3 provides the selection of Class 2 DSM resources by State and Year for years 2015-2018 contained in the 2015 IRP Preferred Portfolio¹⁰.

Table D.3 – Class 2 DSM Resources (2015 IRP Preferred Portfolio, Incremental Resources)

State/Year	2015	2016	2017	2018	Total (MWh)	Total (MW)
California	6,390	7,500	8,580	9,670	32,140	7
Idaho	13,570	15,800	17,570	19,170	66,110	17
Oregon	191,240	168,400	154,140	140,780	654,560	151
Utah	264,360	303,040	333,400	351,640	1,252,440	317
Washington	37,880	41,200	44,600	44,260	167,940	37
Wyoming	37,770	48,180	57,590	68,550	212,090	36
Total (MWh)	551,210	584,120	615,881	634,070	2,385,280	565

Class 3 DSM Resources (price responsive capacity resources)

The Company has numerous Class 3 DSM offerings currently in place encouraging customers to do their part in helping reduce loads during peak use periods. They include metered time-of-day and time-of-use pricing plans (in all states, availability varies by customer class), residential seasonal inverted block rates (Idaho, Utah and Wyoming), residential year-round inverted block rates (California, Oregon and Washington) and the Energy Exchange program (all states). Residential customers not voluntarily opting for a time-of-use rate are currently subject to mandatory seasonal or year-round inverted block rate plans, depending on the state.

Savings realized through customer response to these programs is captured in the Company's historical load information used to inform customer load requirements in the IRP, and as a result is recognized when developing the Company's Preferred Portfolio. Although not a selectable planning resource like Class 1 and 2 DSM resources, Class 3 DSM resources are relied upon to provide important pricing signals as to the time variant cost of electricity and managing peak loads.

In 2014 the Company launched a two year irrigation time-of-use pilot in Oregon. First year results were limited. Following grower meetings and surveys in late 2014 the Company expects 2015 participation and impact results to be more indicative of how growers might respond to a well-designed price product as an alternative to a Class 1 DSM irrigation direct load control program. As noted in the Class 1 DSM section above, the Company plans to propose an irrigation direct load control pilot beginning in 2016 and will compare the results of both approaches for the purpose of developing the most cost efficient and effective strategy to manage these seasonal loads.

⁸ Class 2 DSM capacity reduction represents maximum nameplate rating contribution of the resources selected, not coincident peak reduction.

⁹ For a more thorough comparison of the increase in Class 2 DSM opportunities between the 2013 DSM resource assessment and the 2015 resource assessment see PacifiCorp Demand-Side Resource Potential Assessment For 2015-2034, Volume 2: Class 2 DSM Analysis, Chapter 8 – Comparison With Previous DSM Potential Assessment on the Company's website at [Demand-Side Management Resource Potential Assessment](#)

¹⁰ State specific acquisition forecasts to be filed in states where such requirements exist and may vary from the IRP selection amounts due state specific planning and forecasting requirements/timelines as well as existing program performance results.

Class 4 DSM Resources (Customer Education of Efficient Energy Management)

Educating customers regarding energy efficiency and load management opportunities is an important component of the Company's long-term resource acquisition plan. A variety of channels are used to educate customers including television, radio, newspapers, bill inserts and messages, newsletters, school education programs, and personal contact. The impacts from these messages are captured in customer usage and usage patterns which are taken into consideration in the development of customer load forecasts.

The Company manages a comprehensive DSM communications and outreach plan encouraging customers to use energy wisely by providing low cost or no cost energy savings tips as well as directing customers to Company programs available to help them with efficiency improvements at their homes and businesses.

See the Demand-Side Management Communications & Outreach Plan later in this document for more information on these efforts and details on the Company's 2015 state specific campaigns.

Program Portfolio Offerings by State for DSM Resource Classes 1, 2, and 4

Currently there are two Class 1 DSM programs running within PacifiCorp's six-state service area; Utah's "Cool Keeper" residential and small commercial air conditioner load control program and the irrigation load control program in Utah and Idaho. The two programs contribute approximately 305 MW of load reduction capability, helping the Company better manage demand during peak periods¹¹.

In addition to the Class 1 products, the Company offers ten distinct Class 2 DSM programs or initiatives, most of which are offered in multiple states; size of opportunity and need dependent. In all, the combination of Class 2 DSM programs across PacifiCorp's six states totals twenty-seven¹² with program services in some states combined within programs (i.e. the refrigerator and freezer recycling service in California is part of the Home Energy Savings program and therefore is not counted as a standalone effort). Table D.4 provides a representative overview of the breadth of program services and offerings available by Sector and State. Table D.5 provides a brief overview of DSM related *watt*smart Outreach and Communication activities (Class 4 DSM activities) by state. Energy efficiency services listed in Oregon, except for low income weatherization services, are provided in collaboration with the Energy Trust of Oregon¹³.

¹¹ Actual reductions may vary by event (temperature and month and time dependent), cited load reduction represents the sum of the highest event performance available across the three states for the two programs and account for line losses (are "at generator" values). In addition to these two programs, the Company has additional interruptible load under contract with select Utah and Idaho special contract customers, see Table 5.12 in the 2015 IRP for additional detail.

¹² PacifiCorp collaborates with the Energy Trust of Oregon and the Northwest Energy Efficiency Alliance (in Washington) in delivering two of the ten programs/initiatives. .

¹³ Funds for Low-income weatherization services are forwarded to Oregon Housing and Community Services.

Table D.4 – Existing Program Services and Offerings by Sector and State

Program Services & Offerings by Sector and State	California	Oregon	Washington	Idaho	Utah	Wyoming
<i>Residential Sector</i>						
Refrigerator And Freezer Recycling Program	√	√	√	√	√	√
Lighting Incentives	√	√	√	√	√	√
New Appliance Incentives	√	√	√	√	√	√
Heating And Cooling Incentives	√	√	√	√	√	√
Weatherization Incentives - Windows, Insulation, Duct Sealing, etc.	√	√	√	√	√	√
New Homes	√	√	√		√	√
Low-Income Weatherization	√	√	√	√	√	√
Air Conditioner Direct Load Control					√	
Home Energy Reports		√	√	√	√	√
School Curriculum		√	√		√	
Energy Saving Kits	√	√	√	√	√	√
Financing Options With On-Bill Payments		√				
Trade Ally Outreach	√	√	√	√	√	√
<i>Non-Residential Sector</i>						
Incentives	√	√	√	√	√	√
Energy Engineering Services	√	√	√	√	√	√
Billing Credit Incentive (offset to DSM charge)		√			√	√
Energy Management		√	√	√	√	√
Load Control (<i>Cool Keeper</i>)					√	
Load Control (<i>Irrigation Load Control</i>)				√	√	
Energy Profiler Online	√	√	√	√	√	√
Business Solutions Toolkit	√	√	√	√	√	√
Trade Ally Outreach	√	√	√	√	√	√
Small Business Lighting		√	√	√	√	√
Small to Mid-Sized Business Facilitation	√	√	√	√	√	√
DSM Project Managers Partner With Customer Account Managers	√	√	√	√	√	√

Table D.5 – Existing *wattsmart* Outreach and Communications Activities

wattsmart Outreach & Communications (incremental to program specific advertising)	California	Oregon	Washington	Idaho	Utah	Wyoming
Advertising		√	√	√	√	√
Sponsorships		√			√	
Social Media	√	√	√	√	√	√
Contests (video)					√	
Public Relations (Habitat for Humanity, other)		√	√		√	√
Business Advocacy (awards at customer meetings, sponsorships, chamber partnership, university partnership)		√		√	√	√
wattsmart Workshops		√				
Rockin wattsmart Assemblies					√	

Estimated Expenditures by State and Year¹⁴

Table D.6 provides a preliminary DSM budget by state. The budget represents the expected funding needed to maintain existing initiatives and increase acquisitions necessary to achieve the DSM resources selected in the 2015 IRP; Classes 1, 2 and 4, through 2018.

Table D.6 – Preliminary DSM Program Budget, DSM Classes 1, 2 and 4 (\$000)

State/Year	2015	2016	2017	2018	Total
California	\$2,387	\$2,560	\$2,969	\$3,706	\$11,622
Idaho	\$4,156	\$3,982	\$4,572	\$5,558	\$18,268
Oregon¹⁵	\$42,047	\$37,951	\$35,605	\$33,332	\$148,935
Utah	\$59,893	\$64,960	\$63,625	\$74,045	\$262,523
Washington	\$11,280	\$11,713	\$10,965	\$9,338	\$43,296
Wyoming	\$6,734	\$9,247	\$10,546	\$12,789	\$39,316
Non-Situs Costs¹⁶	\$6,360	\$6,360	\$6,360	\$6,360	25,440
Total¹⁷	\$132,857	\$136,773	\$134,642	\$145,128	\$545,718

State Specific Demand-Side Management Implementation Plans

The Company intends to complement its existing program services and outreach and communications activities in order to facilitate the acquisition of the demand-side resources selected in the 2015 IRP. For information on energy efficiency activities planned in the company's Oregon service area, see the Energy Trust of Oregon's 2015 Annual Budget and 2015-2016 Action Plan.¹⁸ Table D.7 provides a breakdown of the company's implementation items identified to be addressed over the 2015 and 2016 calendar years by sector and state.

¹⁴ Expenditures are estimates based on assumed acquisition costs, including program administration, customer incentives, communications and outreach, and evaluation, measurement and verification expenses. More detailed budgets will be developed as part of the Company's business planning/10-year plan budget work that will occur in the fall of 2015 (October 2015).

¹⁵ Includes the combined SB1149 and SB838 funding forecasts.

¹⁶ Costs associated with the delivery of the Idaho irrigation load control program.

¹⁷ Expenditures exclude costs for Special Contract curtailment resources, which are compensated as a component of their contracted retail rates, and the costs (if approved) of the Oregon and California irrigation load control pilot program.

¹⁸ Plan can be accessed on the Energy Trust of Oregon website at <http://energytrust.org/About/policy-and-reports/Plans.aspx>

Table D.7 – DSM Implementation Items by Sector and State

Sector and State	California	Oregon	Washington	Idaho	Utah	Wyoming
<i>Residential Sector</i>						
Appliance recycling – competitively bid contract for appliance recycling for 2016	√		√	√	√	√
Home energy reports – expand program to residential customers	√					
Home energy reports – implement targeted campaign strategies			√	√	√	√
New construction – revise offering to increase builder participation					√	
New construction – add incentives targeting residential new construction				√		
Home energy savings program – competitively bid contract for 2016	√		√	√	√	√
Multi-family – develop and implement improvements in delivery to the multi-family sector	√		√	√	√	√
Manufactured homes – develop and implement improvements in delivery to the manufactured homes sector	√		√	√	√	√
Low income – add LED replacement bulbs to program	√					
Low income – increase refrigerator replacements in program				√		
Community-based initiatives – support communities participating in 2-year Georgetown University Energy Prize		√	√		√	
<i>Non-Residential Sector</i>						
Lighting – expand commercial LED lighting channels	√		√	√	√	√
Commercial buildings – add system functionality for whole-building benchmarking	√		√	√	√	√
Small to mid-sized business programs – competitively bid contract for mid-2016	√		√	√	√	√
Behavioral pilot – evaluate a small to mid-sized business behavioral pilot program					√	
Targeted business sectors – improve delivery of current programs to the oil and gas sector					√	√
Incentive payments – expand bill credit incentive option (offset to DSM charge)				√		
Energy management – improve delivery capabilities and customer awareness	√		√	√	√	√
Waste heat to power and regenerative technologies – incorporate efficiency measures into business program			√		√	
Irrigation Direct Load Control Pilot	√	√				

2015 Demand-Side Management Communications and Outreach Plan

Overview

The Demand Side Management Communications and Outreach Plan (DCOP) is a comprehensive plan, encompassing all communications to customers and the communities served by Pacific Power and Rocky Mountain Power.

The DCOP incorporates the wattsmart outreach and communications plans for Idaho, Oregon (838), Utah, Washington and Wyoming; See ya later, refrigerator communications; wattsmart Business plans for Idaho, Utah, Washington and Wyoming; Energy FinAnswer and FinAnswer Express plans in California; load control marketing in Utah and Idaho; and demand-side management program marketing activities for all states.

Rocky Mountain Power and Pacific Power working with regulators and interested stakeholders, have implemented comprehensive portfolios of energy efficiency and peak reduction programs in California, Idaho, Oregon, Utah, Washington and Wyoming. Through these portfolios, the Company provides residential, commercial, industrial and agricultural customers with incentives and tools that enable them to employ energy-savings in their home or business. Programs within the portfolio also allow the Company to better manage customer loads during peak usage periods.

Starting with Utah in 2009, the Commission approved the Company’s proposal to implement a communications and outreach plan intended to increase participation in these programs and to grow customer appreciation and understanding of the benefits associated with the efficient use of energy. This document provides detailed information on proposed campaign activities in 2015.

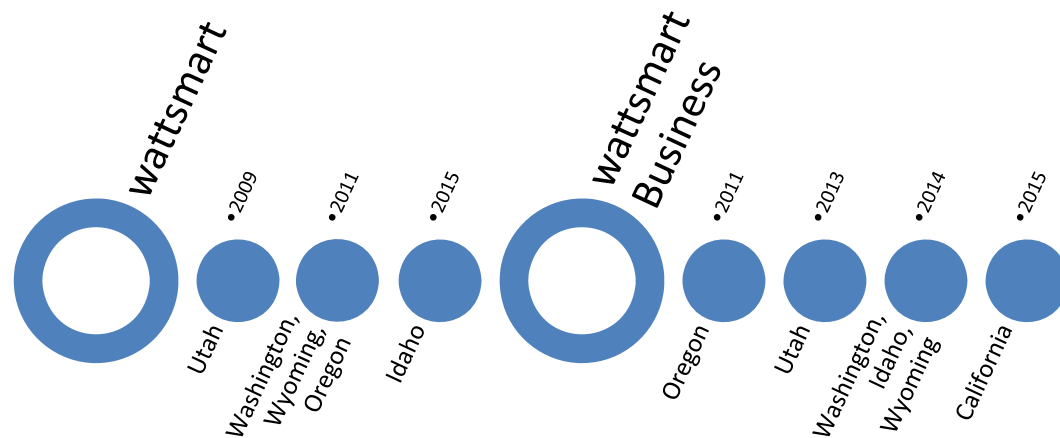

wattsmart is an overarching energy efficiency campaign with the overall goal to engage customers in reducing their energy usage through behavioral changes, and pointing them to the programs and information to help them do it. Rocky Mountain Power/Pacific Power wants to help you save energy and money” is the key message, and the Company utilizes earned media, customer communications advertising and program specific marketing to communicate the value of energy efficiency, provide information regarding low-cost, no-cost energy efficiency measures, and to educate customers on the availability of programs, services and incentives.

The overall paid media plan objective is to effectively reach our customers through a multi-media mix that extends both reach and frequency. Beyond paid media; the Company also uses statement communications, email, website, social media and news coverage. Tapping into all resources with consistent messaging has been the approach and will continue to be refined.

Working with our third-party program marketers, the Company has provided a “*wattsmart* approved” graphic to help customers identify the programs which will help them save energy and money.

In each state the media mix varies depending upon approved budget, reach, readership and ratings. The larger states, where there is greater budget allocation, benefit from utilization of more advertising channels and greater reach and frequency.

Customer Communications Tactics (all states)

Website

- rockymountainpower.net/wattsmart (*wattsmart.com*)
- [pacificpower.net/watt smart](http://pacificpower.net/wattsmart) (*bewattsmart.com*)
- URLs link directly to the energy efficiency landing page. Once there, customers can self-select their state for specific programs and incentives.
- Home page messages promote seasonal *wattsmart*/energy efficiency each month.

Social Media

- Twitter feed promotes energy efficiency tips and *wattsmart* programs multiple times per week.
- Facebook posts watt smart messages three to five times per week.

Newsletters

- **Voices** residential newsletter is sent via bill insert (and email to online bill pay customers) six times a year; each issue includes energy efficiency tips and incentive program information
- **wattsup** insert is a seasonal change insert dedicated to energy efficiency, distributed to customers in May and October.
- **Energy Connections, Energy Update, Energy Insights**, segmented newsletters to businesses and communities leaders, contain articles on commercial and industrial energy efficiency as well as represented case studies on a monthly and quarterly basis.

Messaging

Key messages for wattsmart

- Using energy wisely at home and in your business saves you money.
- Rocky Mountain Power is your energy partner
 - We want to help you keep your costs down.
 - We offer *wattsmart* programs and cash incentives to help you save money and energy in your home or business.

Energy efficiency message focus (all states)

- Earn cash incentives for HVAC equipment, appliances and weatherization upgrades

- Get special pricing on high-efficiency LED and CFL bulbs
- Turn off lights and unplug electronics when not in use
- Recycle your old energy-wasting refrigerator or freezer and earn cash back

Specific message focus for winter peak states (Idaho, Oregon, Washington, Wyoming)

- Keeping the thermostat set to 68 degrees in the winter
- Weatherization upgrades can help you save

Specific message focus for summer peak and cooling in Utah

- Peak use management
- Reducing energy consumption associated with summer cooling;
- Summer tiered pricing
- Evaporative cooling
- Keeping the thermostat set to 78 degrees in the summer
- Enroll in Cool Keeper to help manage the demand for electricity in the summer

Key messages for wattsmart Business

- We can help you save energy and money, which improves your business's bottom line. We offer proven programs and incentives for energy-efficient lighting, heating and cooling systems, motors, compressed air, farm and dairy equipment and more, to help businesses save energy and money.
- Reducing energy costs improves your company's profitability.
- **wattsmart** Business incentives make it simple for your business to save energy and money.
- Using less energy will not only save your business money, it can enhance worker comfort and improve productivity.
- Cash incentives are available for energy-efficient LED lighting for indoor and outdoor applications.
- Energy efficiency is just one way to demonstrate your commitment to sustainable business practices.

California

Residential customer programs

- Home Energy Savings & **wattsmart** Starter Kits
 - Includes Refrigerator/Freezer Recycling (See ya later, refrigerator)
- Low-income Weatherization Services

Business customer programs

- Energy FinAnswer
- FinAnswer Express

The Home Energy Savings program communicates to customers, retailers and trade allies through a variety of channels, including bill inserts, brochures, in-store/point-of-purchase collateral, social media and website.

To help customers start on the path to home energy savings, customers can order free or low-cost *wattsmart* Starter Kits. Kits are promoted through direct mail, Facebook advertising, bill inserts and emails.

In 2015, the Home Energy Savings program will focus on cooling, heating and lighting measures during key seasonal selling windows. Some of the key measures of focus for California will include LED lighting, ductless heat pumps, duct sealing, duct insulation and air sealing.

Driving customers to online incentive information and applications will continue to be a focus this year.

In addition, the Home Energy Savings program will work to maximize opportunities through a well-trained trade ally network.

For the *See ya later, refrigerator* program, the Company will reach customers through print and radio ads, Facebook, bill inserts and newsletters.

The Company will continue its partnership with two local non-profit agencies that install energy efficiency measures in the home of limited income households through the Low-income weatherization program. The service is provided at no-cost to participants.

Business customer program

In 2015, the Company expects to combine the existing *Energy FinAnswer* and *FinAnswer Express* programs into a single program called *wattsmart Business* to make customer participation easier and more streamlined.

The business program will be promoted through a light schedule of radio and print advertising, plus direct mail to irrigation customers. Customer success stories will be featured in print ads and newsletter articles. Customer outreach will be coordinated with trade ally partners.

Oregon

The Company incorporate SB838 spending at seasonally optimal periods to promote “being *wattsmart*” and directing customers to the programs and incentives offered by Energy Trust of Oregon.

Personal Energy Reports continue to be mailed to 11,000 residential customers, and this effort may be expanded in the near future. These reports provide usage comparisons and energy-saving tips.

Business customers will be invited to attend informative events to learn about incentives for lighting and other upgrades available through Energy Trust of Oregon. The Company will develop a brochure and print advertising to showcase Oregon business customer success stories for distribution at events. Irrigation customers will also be targeted with direct mail outreach.

In 2015, the Company will support Bend and Corvallis as the communities compete for the Georgetown University Energy Prize.

Communication Tactic - Oregon	Timing/status
Television, Radio, Newspaper, Outdoor	<ul style="list-style-type: none"> • Starting in March the Company will run TV, radio, print and outdoor. • Focus of the campaign will be saving energy with a strong push to lighting, energy saver kits and Home Energy Review. • The Company will continue to utilize the <i>wattsmart</i>, Oregon campaign developed in 2014. • The Company will utilize Eco Posters in certain markets.
Business print	Starting in January the Company will run in Cascade Business Book of lists as well as the Cascade Business News and Bend Chamber Business Journal
Trail Blazers sponsorship	<p>PacifiCorp developed a business teamwork spot which will run this season in addition to the residential teamwork spot.</p> <ul style="list-style-type: none"> • Two (2) 30 second commercials in Trail Blazers Courtside, airing weekly on the Trail Blazer's Radio Network (56 commercials) • Title sponsorship of Trail Blazers Courtside, airing weekly on the Trail Blazer's Network (28 shows) • One (1) billboard in Trail Blazers Courtside, airing weekly on the Trail Blazers Radio Network (28 shows) • Ninety (90) 30 second commercials in the pre-game show on the Trail Blazers Radio Network during the regular season • Ninety two (92) 30 second radio commercials in play-by-play on the Trail Blazers Radio Network during the regular season • Ninety (90) 30 second radio commercials in the post-game show on the Trail Blazers Radio Network during the regular season
Include <i>banner ads on local sites, blogs, behavioral ad targeting, and pay-per-click ad placements.</i>	Digital ads will be an important part of the media mix.
PR – Capitalize on existing assets and tools to deploy news media outreach and consumer engagement efforts that are aligned with marketing (corporate) objectives.	

Washington

Residential customer programs

- Home Energy Savings & *wattsmart* Starter Kits
- Refrigerator/Freezer Recycling (See ya later, refrigerator)
- See ya later, refrigerator
- Low-income Weatherization Services
- Home Energy Reports
- Be *wattsmart*, Begin at home school curriculum

Business customer programs

- **wattsmart® Business**

The *Home Energy Savings* program communicates to customers, retailers and trade allies through a variety of channels, including bill inserts, brochures, in-store/point-of-purchase collateral, social media and website.

To help customers start on the path to home energy savings, customers can order free or low-cost **wattsmart** Starter Kits. Kits are promoted through direct mail, Facebook advertising, bill inserts and emails.

In 2015, the Home Energy Savings program will focus on cooling, heating and lighting measures during key seasonal selling windows. Some of the key measures of focus for Washington will include LED lighting, ductless heat pumps, duct sealing, duct insulation and air sealing.

Driving customers to online incentive information and applications will continue to be a focus this year.

In addition, the Home Energy Savings program will work to maximize opportunities through a well-trained trade ally network.

See ya later, refrigerator recycling TV and digital advertising will run in the spring and summer to encourage participation. The Company will also reach customers through bill inserts, newsletters and social media.

The Company will continue its partnership with three local non-profit agencies that install energy efficiency measures in the home of limited income households through our Low-income weatherization program. The service is provided at no-cost to participants.

Home Energy Reports are mailed to approximately 52,000 residential customers with usage comparisons and energy-saving tips. Customer with valid emails are sent an electronic version of their report and directed to go online where they can view more information about their energy usage and other residential programs and services.

The **wattsmart** Business program will be promoted through radio, print and digital with the addition of LinkedIn ads in 2015. Customer success stories will be featured in print ads and newsletter articles. Direct mail and email will target vertical markets and outreach will be coordinated with trade ally partners to reinforce messaging in direct mail with industry specific incentives and targeted events.

In 2015, the Company will support Walla Walla as the community competes for the Georgetown University Energy Prize.

Communication Tactic - Washington	Timing/status
Television: A selection of ads will be rotated, both 30-second and 15-second TV spots, with an average of 100 TV placements each week that the campaign is on the air.	Utilize creative developed in 2014.

Communication Tactic - Washington	Timing/status
KAPP (ABC), KIMA (CBS), KNDO (NBC), KUNV (UNIV) and Charter (Cable).	
Radio: An average of 100 radio spots per week. Radio stations on which campaign spots will air include KARY-FM (Oldies), KATS-FM (Classic Rock), KDBL-FM (Country), KFFM-FM (Contemporary Hits), KHHK-FM (Rhythmic CHR) KRSE-FM (Modern), KXDD-FM (Country), KZTA-FW (Mexican Regional).	Utilize creative developed in 2014.
Newspaper Dayton Chronicle, The East Washingtonian, La Voz Hispanic News, The Waitsburg Times, Walla Walla Union Bulletin and Yakima Herald-Republic.	Utilize creative developed in 2014.
Digital	Include <i>banner ads on local sites, blogs, behavioral ad targeting, and pay-per-click ad placements and digital search for business customers</i> . Utilize creative developed in 2014.
PR: Capitalize on existing assets and tools to deploy news media outreach and consumer engagement efforts that are aligned with marketing (corporate) objectives.	

Idaho

Residential programs

- Home Energy Savings & *wattsmart* Starter Kits
- Refrigerator/Freezer Recycling (See ya later, refrigerator)
- Low-income Weatherization Services
- Home Energy Reports

Business programs

- *wattsmart* Business
- Irrigation Load Control

The *Home Energy Savings* program communicates to customers, retailers and trade allies through a variety of channels, including bill inserts, brochures, in-store/point-of-purchase collateral, social media and website.

To help customers start on the path to home energy savings, customers can order free or low-cost *wattsmart* Starter Kits. Kits are promoted through direct mail, Facebook advertising, bill inserts and emails.

In 2015, the Home Energy Savings program will focus on cooling, heating and lighting measures during key seasonal selling windows. Some of the key measures of focus for Idaho will include LED lighting, ductless heat pumps, and duct sealing, duct insulation and air sealing.

Driving customers to online incentive information and applications will continue to be a focus this year.

In addition, the Home Energy Savings program will work to maximize opportunities through a well-trained trade ally network.

See ya later, refrigerator recycling digital advertising will run in the spring and summer to encourage participation. The Company will also reach customers through bill inserts, newsletters and social media.

The Company will continue its partnership with two local non-profit agencies that install energy efficiency measures in the home of limited income households through the Low-income weatherization program. The service is provided at no-cost to participants.

Home Energy Reports are mailed to approximately 17,250 residential customers with usage comparisons and energy-saving tips. Customer with valid emails are sent an electronic version of their report and directed to go online where they can view more information about their energy usage and other residential programs and services.

The *wattsmart* Business program will be promoted through radio and print. Customer success stories will be featured in print ads and newsletter articles. Direct mail and email will target vertical markets and outreach will be coordinated with trade ally partners to reinforce messaging in direct mail with industry specific incentives and targeted events.

Communication Tactic - Idaho	Timing/status
Television - Idaho Falls: A selection of ads will be rotated, both 30-second and 15-second TV spots.	New TV spots in 2015
Radio - Idaho Falls	New spots in 2015
Newspapers: <ul style="list-style-type: none"> • Jefferson Star/Shelley Pioneer • Idaho State Journal • Idaho Falls Post Register • News-Examiner • Preston Citizen • Rexburg Standard Journal 	New print ads in 2015 to support the broadcast campaign and business programs.
PR – Capitalize on existing assets and tools to deploy news media outreach and consumer engagement efforts that are aligned with marketing (corporate) objectives.	
Digital Display and Google Search – Idaho Falls	Include <i>banner ads on local sites, blogs, behavioral ad targeting, and pay-per-click ad placements.</i>
Home Energy Reports	Direct mail and email to targeted customers throughout the year

Utah

Residential customer programs

- Home Energy Savings & *wattsmart* Starter Kits
- Refrigerator/Freezer Recycling (See ya later, refrigerator)
- Low-income Weatherization Services
- Air Conditioner Load Control (Cool Keeper)

- Home Energy Reports
- Be *wattsmart*, Begin at home school curriculum

Business customer program

- *wattsmart*® Business
- Small Business Air Conditioner Load Control (Cool Keeper)
- Irrigation Load Control

wattsmart advertising remains strong and will introduce new creative (“*wattsmart*, Utah”) which will be featured in TV spots, radio commercials, print, transit and digital mediums, incorporated into the school curriculum program and featured at local events, be part of the University of Utah sponsorship, and will include a digital game and video contest.

High-level plans for *wattsmart* programs:

- See ya later, refrigerator recycling TV and digital advertising will run throughout the spring and summer to encourage participation.
- The Company will continue its partnerships with local non-profit agencies that install energy efficiency measures in the home of limited income households through the Low-income weatherization program. The service is provided at no-cost to participants.
- *wattsmart* incentives and *wattsmart* Starter Kits (new for 2015) will be promoted primarily through bill inserts, newsletters, email, website features, social media, in-store/point-of-purchase collateral and the spring and fall home show events. New applications will allow customers to apply for more incentives online.
- In 2015, the Home Energy Savings program will focus on cooling, heating and lighting measures during key seasonal selling windows. Some of the key measures of focus for Utah will include LED lighting, electronically commutated motors, ductless heat pumps, and duct sealing, duct insulation and air sealing.
- Rocky Mountain Power will again participate in the Spring Home & Garden Festival with a booth offering customers free *wattsmart* Starter Kits as well as other activities to draw interest and engagement.
- Cool Keeper air conditioning load control will be promoted through door-to-door canvassing, call center education during new customer account setup, bill inserts and on-report messaging to participating home energy report customers.
- Home Energy Reports continue to be mailed to approximately 290,000 residential customers with usage comparisons and energy-saving tips.
- *wattsmart* Business will be promoted through traditional advertising as well as LinkedIn and digital search and the business advocacy outreach efforts. Customer success stories will be featured in print ads and newsletter articles. Direct mail and email will target vertical markets and outreach will be coordinated with trade ally partners to reinforce messaging in direct mail with industry specific incentives and targeted events.

In 2015, the Company will support Park City/Summit County and Kearns as the communities compete for the Georgetown University Energy Prize.

Communication Tactic - Utah	Timing/status
Television	Develop new creative in 2015
Radio	Develop new creative in 2015

Communication Tactic - Utah	Timing/status
Newspapers	Develop new creative in 2015
Outdoor/transit	Develop new creative in 2015
Sponsorships	SL Real, University of Utah Football, Basketball and Women's Gymnastics, KUED Children's Programming, Ragnar Relay
Mobile game	Develop a custom <i>wattsmart</i> energy efficiency mobile game promoted via banner ads and social media
Act <i>wattsmart</i> video contest	Launch in March 2015, Contest runs through mid-May. Winner announced Mid-June
Education component	<i>wattsmart</i> Begin at Home runs through 2014/15 school year and RFP for 2015/16 school year; Rockin <i>wattsmart</i> assemblies
PR – Capitalize on existing assets and tools to deploy news media outreach and consumer engagement efforts that are aligned with marketing (corporate) objectives.	

Wyoming

Residential programs

- Home Energy Savings & *wattsmart* Starter Kits
- Refrigerator/Freezer Recycling (See ya later, refrigerator)
- Low-income Weatherization Services
- Home Energy Reports

Business programs

- *wattsmart*® Business

“*wattsmart*, Wyoming” and *wattsmart* Business campaigns will play early advertising roles in 2015.

The Home Energy Savings program communicates to customers, retailers and trade allies through a variety of channels, including bill inserts, brochures, in-store/point-of-purchase collateral, social media and website.

In 2015, the Home Energy Savings program will focus on cooling, heating and lighting measures during key seasonal selling windows. Some of the key measures of focus for Wyoming will include LED lighting, ECMs, ductless heat pumps, duct sealing, duct insulation, air sealing and *wattsmart* Starter Kits (new for 2015).

Driving customers to online incentive information and applications will continue to be a focus this year.

In addition, the Home Energy Savings program will work to maximize opportunities through a well-trained trade ally network.

See ya later, refrigerator recycling TV and digital advertising will run in the spring and summer to encourage participation. The Company will also reach customers through bill inserts, newsletters and social media.

The Company will continue its partnerships with local non-profit agencies that install energy efficiency measures in the home of limited income households through the Low-income weatherization program. The service is provided at no-cost to participants.

Home Energy Reports are mailed to approximately 18,000 residential customers with usage comparisons and energy-saving tips. Customers with valid emails are sent an electronic version of their report and directed to go online where they can view more information about their energy usage and other residential programs and services.

The *wattsmart* Business program will be promoted through radio, print and digital with the addition of LinkedIn ads in 2015. Customer success stories will be featured in print ads and newsletter articles. Direct mail and email will target vertical markets and outreach will be coordinated with trade ally partners to reinforce messaging in direct mail with industry specific incentives and targeted events.

Communication Tactic - Wyoming	Timing/status
Television: A selection of ads will be rotated, both 30-second and 15-second TV spots.	Utilize creative developed in 2014.
Radio	Utilize creative developed in 2014.
Newspapers: Cody Enterprise, Powell Tribune, Casper Star-Tribune, Riverton Ranger, Laramie Boomerang, Rock Springs Rocket-Miner, Green River Star, Kemmerer Gazette, Rawlins Daily Times Other papers to consider: Uinta Daily Herald in Evanston, Douglas Budget/Glenrock Independent and the Casper Journal.	Utilize creative developed in 2014.
Outdoor	Poster coverage—Utilize creative developed in 2014.
PR – Capitalize on existing assets and tools to deploy news media outreach and consumer engagement efforts that are aligned with marketing (corporate) objectives.	
Digital	Include <i>banner ads on local sites, blogs, behavioral ad targeting, and pay-per-click ad placements.</i> Utilize creative developed in 2014.

Communications and Outreach Budget

The 2015 *wattsmart* outreach and communications budget is \$2,650,000¹⁹ and is included in the forecasted dollars in Table D.6 – Preliminary DSM Program Budget, DSM Classes 1, 2 and 4 provided earlier in Appendix D.

¹⁹ The Company is working on expanding current the current *wattsmart* DSM outreach and communications funding in some states and implementing funding in California effective 2016. This plan and funding complements other company efficiency messaging as well as program specific advertising whose costs are captured within the specific program's budget.

In addition to the above communications and outreach, the Company supports networks of trade allies (contractors, distributors, manufacturer representatives, etc.) who can bring the business customer program offering to their clients and encourage them to upgrade to higher efficiency equipment. Similarly, the Company implements other customer direct outreach efforts including “eblast” email communications, targeted town events, one-on-one customer calls/visits and more.

APPENDIX E – SMART GRID

Introduction

The Smart Grid is the application of advanced communications and controls to the electric power system, including generation, transmission, distribution, and the customer premise. As a result, a wide array of applications can be defined under the smart grid umbrella. Smart Grid technologies include dynamic line rating, phasor measurement units (synchrophasors), energy storage, power line sensors, distribution automation, integrated volt/var optimization, advanced metering infrastructure, automated demand response, and smart renewable and/or distributed generation controls (e.g., smart inverters).

For PacifiCorp the smart grid definition started with a review of relevant technologies for transmission, substation and distribution systems, as well as smart metering and home area networks, which enable consumer response to price fluctuations and load curtailment requests. For the interoperation of these technologies the most critical infrastructure decision to be made during smart grid design is the communications network. This network must be high speed, secure and highly reliable, and must be scalable to support PacifiCorp's entire service territory. The network must accommodate both normal and emergency operation of the electrical system and must be available at all times, especially during the first critical moments of a large-scale disturbance to the system.

PacifiCorp regularly evaluates the applicability of smart grid technologies to the power system. Applications that show a positive net benefit for PacifiCorp's customers are implemented where they are needed. Technologies that PacifiCorp has tested or implemented include dynamic line rating, synchrophasors, and communicating faulted circuit indicators. Technologies studied, but not considered in the smart-grid financial analysis, include fully redundant "self-healing" distribution systems, distributed energy systems (including electric vehicles) and direct load control programs.

It is PacifiCorp's goal to leverage smart grid technologies in a way that aligns with the Integrated Resource Plan (IRP) goals to achieve a portfolio that is chosen based on least-cost/least-risk metrics. This will result in an optimized electrical grid when and where it is economically feasible, operationally beneficial, and in the best interest of customers. Through a comprehensive review and analysis of smart grid report published each year, PacifiCorp is able to ascertain the value proposition of emerging technologies and, at the appropriate time, recommend them for demonstration or integration. Included for reference on the data disk accompanying the 2015 IRP are the most recent reports filed in the states of Oregon, Utah, Washington, and Wyoming. The overall goal is to work in synchronicity with state commissions, with goals of improving reliability, increasing energy efficiency, enhancing customer service, and integrating renewable resources. These goals will be met by utilizing strategies that employ analyzing the total cost of ownership, performing well researched cost-benefit analyses, and focusing on customer outreach.

In order to mitigate the costs and risks to the Company and its customers it is essential that technology leaders be identified and that system interoperability and security issues be verified and resolved with national standards. PacifiCorp will continue to monitor technological advances and utility developments throughout the nation as more advanced metering and other smart grid

related projects are built. This will allow for improved estimates of both costs and benefits. With large-scale deployments progressing throughout the country, it is expected that the smart grid market leaders will become evident within the next few years. Demonstration projects will reveal the sustainability of large-scale rollouts and give utilities a better idea of which areas of the smart grid are best suited for implementation on their systems.

Transmission System Efforts

Dynamic Line Rating

Dynamic line rating is the application of sensors to transmission lines, which indicate the real-time current-carrying capacity of the lines. Transmission lines are generally rated by an assumption of worst-case condition of the season (e.g., hottest summer day or coldest winter day). Dynamic line rating allows an increased capacity during times when this assumption does not hold true.

Two dynamic line rating projects were implemented in 2014. One project, Miners-Platte, is operational. The other project, West-of-Populus, requires further data collection and analysis. West-of-Populus is planned to be operational in 2015.

Dynamic line rating is considered for all future transmission needs as a means for increasing capacity vis-à-vis traditional construction methods. Dynamic line rating is only applicable for thermal constraints and provides capacity only during site-dependent time periods, which may or may not align with the expected transmission need. Dynamic line rating is but one tool within the transmission planner's toolbox to be considered when applicable.

Synchrophasors

Transmission synchrophasors, also called phasor measurement units, can lead to a more reliable network by comparing phase angles of certain network elements with a base element measurement. The phasor measurement unit can also be used to increase reliability by synchrophasor-assisted protection due to line condition data being relayed faster through the communication network. Phasor measurement unit implementation and further development may enable transmission operators to integrate variable resources and energy storage more effectively into their balancing areas and minimize service disruptions.

PacifiCorp participated in the Western Electricity Coordinating Council (WECC) Western Interconnection Synchrophasor Project (WISP). The Company, and many other utilities installed phasor measurement units throughout the WECC, and that are currently collection data. The project will support WECC and Peak Reliability, which was formed through a division of WECC, to maintain the stability of the power system. PacifiCorp installed a total of eight phasor measurement units at eight substations. WECC and Peak Reliability are continuing to develop data access for utility participants. The system of synchrophasors will support the prevention of system blackouts, as well as provide historical data for the analysis of any future power system failure. The data may prove useful for utility operations in the future.

Distribution System Efforts

Distribution Reliability Efforts: Communicating Faulted Circuit Indicators

Traditional non-communicating faulted circuit indicators are used to visually indicate fault current paths on the distribution system, while communicating faulted circuit indicators wirelessly by sending a signal to the utility. Communicating faulted circuit indicators have the

potential to improve reliability indices, such as customer average interruption duration index (CAIDI), by reducing the amount of time associated with initial fault reporting and determining fault location.

Project Summary

PacifiCorp has installed 48 communicating faulted circuit indicators in early 2014. Future actions include integration with PacifiCorp's outage management system, validation, and cost/benefit analysis; these actions are anticipated to be complete in spring of 2015. The communicating faulted circuit indicators were installed on five circuits in eastern Utah in March 2014. These circuits had poor reliability, were in difficult-to-access rural areas, and had limited supervisory control and data acquisition (SCADA).

Sensor alerts and loading data are currently being hosted through a vendor-hosted web portal accessed by area engineers and dispatchers. A project to integrate communicating faulted circuit indicators sensor data with the Company's outage management system is in progress. Integration of the communicating faulted circuit indicators and outage management system is expected to provide operation personnel with an enhanced view of system status and accelerate the use of the data from new equipment. Validation of sensor performance is on-going; a cost-benefit analysis should be complete by spring of 2015. Given positive results this technology will be considered for similar circuits elsewhere.

Customer Information and Demand-Side Management Efforts

Advanced Metering Strategy

PacifiCorp has been evaluating the applicability of smart meters to its Oregon service area. PacifiCorp expended considerable effort during 2014 further developing and refining its strategy aimed at implementing an advanced metering system (AMS) in the state of Oregon. Potential benefits as well as costs were researched, evaluated, and refined, producing multiple business case models. PacifiCorp's objectives were threefold; identify a solution and strategy that would deliver solid projected benefits to our customers, deliver financial results that make economic sense, and minimize impact on consumer rates.

PacifiCorp made significant headway during 2014 in expanding its understanding of the implications for implementing an advanced metering system in the state of Oregon. The costs were further refined through the request for proposal process and enabled PacifiCorp to clarify the economics and better understand the full impact that a system of this nature will have on customers. The results of the proposals and associated economic analyses were encouraging and further work with vendors is scheduled in the upcoming months. A final decision on the project is expected in late 2015.

Future Smart Grid

PacifiCorp is continuing to evaluate smart grid technologies that may benefit customers as well as validating those that are being piloted. PacifiCorp regularly develops and updates a business case to examine the quantifiable costs and benefits of a smart grid system and each individual component. While the net present value of implementing a comprehensive smart grid system throughout PacifiCorp is negative at this time, PacifiCorp has implemented specific projects and programs that have positive benefits for customers, and explored pilot projects in other areas of interest.

APPENDIX F – FLEXIBLE RESOURCE NEEDS ASSESSMENT

Introduction

In its Order No. 12013 issued on January 19, 2012 in Docket No. UM 1461 on “Investigation of matters related to Electric Vehicle Charging,” the Oregon Public Utility Commission (OPUC) adopted the OPUC staff’s proposed IRP guideline:

1. **Forecast the Demand for Flexible Capacity:** The electric utilities shall forecast the balancing reserves needed at different time intervals (e.g. ramping needed within 5 minutes) to respond to variation in load and intermittent renewable generation over the 20-year planning period;
2. **Forecast the Supply of Flexible Capacity:** The electric utilities shall forecast the balancing reserves available at different time intervals (e.g. ramping available within 5 minutes) from existing generating resources over the 20-year planning period; and
3. **Evaluate Flexible Resources on a Consistent and Comparable Basis:** In planning to fill any gap between the demand and supply of flexible capacity, the electric utilities shall evaluate all resource options including the use of electric vehicles (EVs), on a consistent and comparable basis.

In this appendix, the Company first identifies its flexible resource needs for the IRP study period of 2015 through 2034, and the calculation method used to estimate those requirements. The Company then identifies its supply of flexible capacity from its generation resources, in accordance with the Western Electricity Coordinating Council (WECC) operating reserves guidelines, demonstrating that PacifiCorp has sufficient flexible resources to meet its requirements.

Flexible Resource Requirements Forecast

PacifiCorp’s flexible resource needs are the same as its operating reserves requirements over the planning horizon for maintaining reliability and compliance with the North American Electric Reliability Corporation (NERC) regional reliability standards. NERC regional reliability standard BAL-002-WECC-2 requires each Balancing Authority Area to carry sufficient operating reserve at all times.²⁰ Operating reserve consists of contingency reserve and regulating margin. Each type of operating reserve is further defined below.

Contingency Reserve

Contingency reserve is capacity that the Company holds in reserve to respond to unforeseen events on the power system, such as an unexpected outage of a generator or a transmission line. Contingency reserve may not be applied to manage other system fluctuations such as changes in load or wind generation output.

²⁰ <http://www.nerc.com/files/BAL-002-WECC-2.pdf>

Regulating Margin

Regulating margin is the additional capacity the Company holds in reserve to ensure it has adequate reserve levels at all times to meet the NERC Control Performance Criteria in BAL-001-2²¹. In this IRP, the Company further segregates regulating margin into two components: ramp reserve and regulation reserve, which are discussed in more details in Volume II, Appendix H, PacifiCorp’s 2014 Wind Integration Study (WIS). They are summarized here, as follows:

Ramp Reserve: Both load and wind change from minute-to-minute, hour-to-hour, continuously at all times. This variability requires ready capacity to follow changes in load and wind continuously, through short deviations, at all times. Treating this variability as though it is perfectly known (as though the operator would know exactly what the net balancing area load would be a minute from now, 10-minutes from now, and an hour from now) and allowing just enough generation flexibility on hand to manage it defines the ramp reserve requirement of the system.

Regulation Reserve: Changes in load or wind generation which are not considered contingency events, but require resources be set aside to meet the needs created when load or wind generation change unexpectedly. The Company has defined two types of regulation reserve: those covering short term variations (moment to moment using automatic generation control) in system load and wind (“regulating reserve”), and those covering uncertainty across an hour when forecast changes unexpectedly (“following reserves”).

Since contingency reserve and regulating margin are separate and distinct components, PacifiCorp estimates the forward requirements for each separately. The contingency reserve requirements are derived from a stochastic simulation study which captures the changes in the hourly interchange and generation dispatch of the preferred portfolio. These simulations were run using the Planning and Risk (PaR) model. The regulating margin requirements are part of the inputs to the PaR model, and are calculated by applying the methods developed in the WIS. For this study and given the similar response time requirements of the two regulating margin components, they are grouped together with spinning reserves for modeling in this IRP. The reserve requirements for PacifiCorp’s two balancing authority areas are shown in Table F.1.

²¹ NERC Standard BAL-001-2: <http://www.nerc.com/files/BAL-001-2.pdf>.

Table F.1 – Reserve Requirements (MW)

Year	East Requirement		West Requirement	
	Spin	Non-Spin	Spin	Non-Spin
2015	624	209	250	90
2016	626	204	253	91
2017	631	208	254	92
2018	634	211	255	93
2019	634	213	255	94
2020	636	216	256	95
2021	637	217	258	96
2022	640	220	246	97
2023	639	222	247	97
2024	639	223	244	98
2025	632	224	245	99
2026	635	226	246	100
2027	638	230	247	100
2028	642	235	247	101
2029	640	233	243	101
2030	634	234	242	102
2031	621	236	243	103
2032	623	242	244	103
2033	604	241	244	104
2034	613	250	244	105

Flexible Resource Supply Forecast

Requirements by NERC and the WECC dictate the types of resources that can be used to serve the reserve requirements. For contingency reserves, at least one half of the requirements are spinning reserves, while the remainder are non-spinning reserves:

- Spinning reserves can only be served by resources currently online and synchronized to the transmission grid;
- Non-spinning reserves may be served by fast-start resources that are capable of being online and synchronized to the transmission grid within ten minutes. Interruptible load can only serve non-spinning reserves. Non-spinning reserves may be served by resources that are capable of providing spinning reserves.

Regulation reserves are added to the spinning half of the contingency reserve requirements, which are referred to as spinning reserves in the subsequent discussions.

The resources that PacifiCorp employs to serve its reserve requirements include owned hydro resources that have storage, owned thermal resources, and purchased power contracts that provide the Company with reserve capabilities.

Hydro resources are generally deployed first to meet the spinning reserve requirements because of their flexibility and their ability to respond quickly. The amount of reserves that these

resources can provide depends upon the difference between their expected capacities and their generation level at the time. The hydro resources that PacifiCorp may use to cover reserve requirements in the PacifiCorp West balancing authority area include its facilities on the Lewis River and the Klamath River as well as contracted generation from the Mid-Columbia projects. In the PacifiCorp East balancing authority area, the Company may use facilities on the Bear River to provide spinning reserves.

Thermal resources are also used to meet the spinning reserve requirements when they are online. The amount of reserves provided by these resources is determined by their ability to ramp up within a 10-minute interval. For natural gas-fired thermal resources, the amount of reserves can be close to the differences between their nameplate capacities and their minimum generation levels. In the current IRP, PacifiCorp’s reserves are served not only from existing coal- and gas-fired resources that the Company operates, but also from new gas-fired resources selected in the preferred portfolio.

Table F.2 lists the annual capacity of resources that are capable of serving reserves in PacifiCorp’s East and West balancing authority areas. All the resources included in the calculation are capable of providing all types of reserves. The non-spinning reserve resources under third party contracts are excluded in the calculations. The changes in the flexible resource supply reflect retirement of existing resources, addition of new preferred portfolio resources, variation in hydro capability due to forecasted streamflow conditions, and expiration of contracts from the Mid-Columbia projects that are reflected in the preferred portfolio.

Table F.2 – Flexible Resource Supply Forecast (MW)

Year	East Supply	West Supply
2015	1,100	794
2016	1,100	770
2017	1,096	746
2018	1,096	752
2019	1,096	774
2020	1,097	774
2021	1,097	745
2022	1,097	745
2023	1,097	745
2024	1,097	745
2025	1,097	745
2026	1,097	745
2027	1,097	745
2028	1,242	745
2029	1,242	745
2030	1,438	745
2031	1,438	745
2032	1,438	745
2033	1,503	745
2034	1,773	745

Figure F.1 and Figure F.2 graphically display the balances of reserve requirements and capability of spinning reserve resources in PacifiCorp’s East and West balancing authority areas

respectively. The graphs demonstrate that PacifiCorp’s system has sufficient resources to serve its reserve requirements throughout the IRP planning period.

Figure F.1 – Comparison of Reserve Requirements and Resources, East Balancing Authority Area (MW)

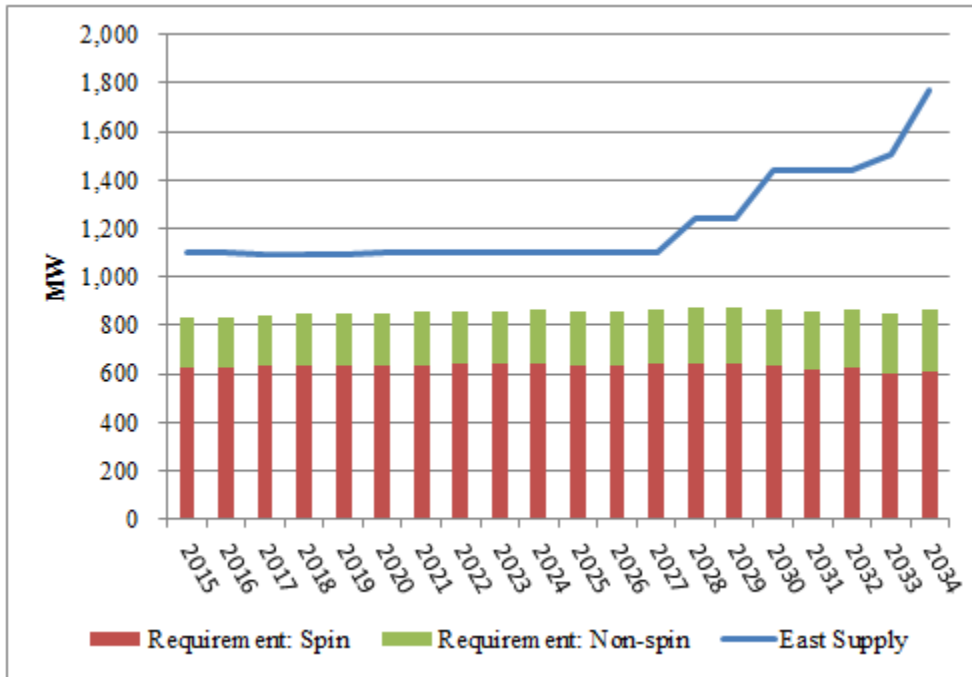
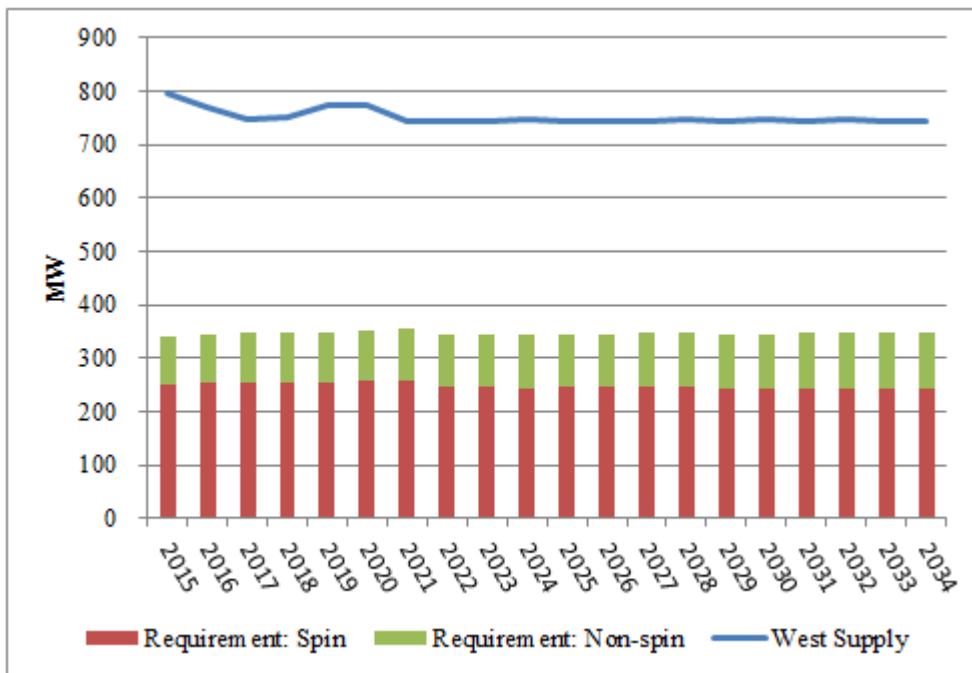

Figure F.2 – Comparison of Reserve Requirements and Resources, West Balancing Authority Area (MW)



Flexible Resource Supply Planning

In actual operations, PacifiCorp has been able to serve its reserve requirements and has not experienced any incidences where it was short of reserves. PacifiCorp manages its resources to meet its reserve obligation in the same manner as meeting its load obligation – through long term planning, market transactions, utilization of the transmission capability between the two balancing authority areas, and operational activities that are performed on an economic basis.

PacifiCorp and the California Independent System Operator Corporation implemented the energy imbalance market (EIM) on November 1, 2014. This implementation is expected to provide a more optimized economic dispatch of PacifiCorp's resources and may eventually reduce regulating margin requirements.

As indicated in the OPUC order, electric vehicle technologies may be able to meet flexible resource needs at some point in the future. However, the electric vehicle technology and market have not developed sufficiently to provide data for the current study. Since this analysis shows no gap between forecasted demand and supply of flexible resources over the IRP planning horizon, this IRP does not include whether electric vehicles could be used to meet future flexible resource needs.

APPENDIX G – PLANT WATER CONSUMPTION

The information provide in this appendix is for PacifiCorp owned plants. Total water consumption and generation includes all owners for jointly-owned facilities

Table G.1 – Plant Water Consumption with Acre-Feet Per Year

Plant Name	Zero Discharge	Cooling Media	Acre-Feet Per Year					MWhs Per Year					
			2010	2011	2012	2013	Average	2010	2011	2012	2013	Gals/MWH	GPM/MW
Carbon		Utah	2,193	2,458	2,307	1940	2,241	1,296,004	1,332,218	1,287,240	1,197,765	582	9.7
Chehalis		Washington	24	43	55	86	52	1,296,741	664,323	849,938	1,674,194	15	0.2
Currant Creek	Yes	Utah	82	78	90	84	87	2,536,660	2,397,142	2,132,523	2,359,924	12	0.2
Dave Johnston		Wyoming	6,604	7,233	7,721	8941	7,538	4,704,694	5,059,927	4,906,422	5,295,081	481	8.0
Gadsby		Utah	893	864	1,059	610	755	359,404	194,389	214,739	339,592	672	11.2
Hunter	Yes	Utah	18,941	16,961	18,266	17001	18,308	8,785,827	8,719,300	9,118,876	9,546,313	641	10.7
Huntington	Yes	Utah	9,549	9,069	10,423	10643	10,332	6,107,379	5,961,371	6,744,160	6,768,625	512	8.5
Jim Bridger	Yes	Wyoming	20,757	22,282	23,977	25059	24,126	14,828,906	12,771,611	13,625,135	14,817,041	545	9.1
Lake Side		Utah	1,533	1,154	1,693	1361	1,475	2,537,046	1,781,198	2,890,938	2,508,960	196	3.3
Naughton		Wyoming	13,354	14,157	8,745	9622	11,286	5,339,385	5,102,251	5,056,959	5,533,895	714	11.9
Wyodak	Yes	Wyoming	396	367	322	319	369	2,565,341	1,831,459	2,526,307	2,518,120	48	0.8
TOTAL			74,326	74,664	74,658	75,666	78,143	50,357,387	45,815,189	49,353,237	52,559,510	411	6.8

**Gadsby includes a mix of both rankine steam units and peaking gas turbines

Plants Owned and Operated by PacifiCorp

Total water consumption and generation includes all owners for jointly-owned facilities

1 acre-foot of water is equivalent to: 325,851 Gallons or
 43,560 Cubic Feet

Table G.2 – Plant Water Consumption by State (acre-feet)

UTAH PLANTS						
Plant Name	2008	2009	2010	2011	2012	2013
Carbon	2,199	2,349	2,193	2,458	2,307	1,940
Currant Creek	82	108	82	78	90	84
Gadsby	426	680	893	864	1,059	610
Hunter	19,380	19,300	18,941	16,961	18,266	17,001
Huntington	11,385	10,922	9,549	9,069	10,423	10,643
Lake Side	1,821	1,287	1,533	1,154	1,693	1,361
TOTAL	35,293	34,646	33,191	30,583	33,838	31,639

Percent of total water consumption = 43.4%

WYOMING PLANTS						
Plant Name	2008	2009	2010	2011	2012	2013
Dave Johnston	7,746	6,983	6,604	7,233	7,721	8,941
Jim Bridger	27,322	25,361	20,757	22,282	23,977	25,059
Naughton	10,992	10,846	13,354	14,157	8,745	9,622
Wyodak	446	365	396	367	322	319
TOTAL	46506	43555	41111	44039	40765	43941

Percent of total water consumption = 56.6%

Table G.3 – Plant Water Consumption by Fuel Type (acre-feet)

COAL FIRED PLANTS							Generation Capacity	Ac-ft/MW
Plant Name	2008	2009	2010	2011	2012	2013		
Carbon	2,199	2,349	2,193	2,458	2,307	1,940	172	13.0
Dave Johnston	7,746	6,983	6,604	7,233	7,721	8,941	762	9.9
Hunter	19,380	19,300	18,941	16,961	18,266	17,001	1,341	13.6
Huntington	11,385	10,922	9,549	9,069	10,423	10,643	903	11.4
Jim Bridger	27,322	25,361	20,757	22,282	23,977	25,059	2,118	11.4
Naughton	10,992	10,846	13,354	14,157	8,745	9,622	700	16.1
Wyodak	446	365	396	367	322	319	335	1.1
TOTAL	79,470	76,126	71,794	72,526	71,761	73,525	Average	10.9

Percent of total water consumption = 97.0%

NATURAL GAS FIRED PLANTS							Generation Capacity	Ac-ft/MW
Plant Name	2008	2009	2010	2011	2012	2013		
Currant Creek	82	108	82	78	90	84	537	0.2
Gadsby	426	680	893	864	1,059	610	351	2.2
Lake Side	1,821	1,287	1,533	1,154	1,693	1,361	544	2.7
TOTAL	2,329	2,075	2,508	2,096	2,842	2,055	Average	1.7

Percent of total water consumption = 3.0%

Table G.4 – Plant Water Consumption for Plants Located in the Upper Colorado River Basin (acre-feet)

Plant Name	2008	2009	2010	2011	2012	2013
Hunter	19,380	19,300	18,941	16,961	18,266	17,001
Huntington	11,385	10,922	9,549	9,069	10,423	10,643
Carbon	2,199	2,349	2,193	2,458	2,307	1,940
Naughton	10,992	10,846	13,354	14,157	8,745	9,622
Jim Bridger	27,322	25,361	20,757	22,282	23,977	25,059
TOTAL	71,278	68,778	64,794	64,927	63,718	64,265

Percent of total water consumption = 86.6%

APPENDIX H – WIND INTEGRATION STUDY

Introduction

This wind integration study (WIS) estimates the operating reserves required to both maintain PacifiCorp's system reliability and comply with North American Electric Reliability Corporation (NERC) reliability standards. The Company must provide sufficient operating reserves to meet NERC's balancing authority area control error limit (BAL-001-2) at all times, incremental to contingency reserves, which the Company maintains to comply with NERC standard BAL-002-WECC-2.^{22,23} Apart from disturbance events that are addressed through contingency reserves, these incremental operating reserves are necessary to maintain area control error²⁴ (ACE), due to sources outside direct operator control including intra-hour changes in load demand and wind generation, within required parameters. The WIS estimates the operating reserve volume required to manage load and wind generation variation in PacifiCorp's Balancing Authority Areas (BAAs) and estimates the incremental cost of these operating reserves.

The operating reserves contemplated within this WIS represent regulating margin, which is comprised of ramp reserve, extracted directly from operational data, and regulation reserve, which is estimated based on operational data. The WIS calculates regulating margin demand over two common operational timeframes: 10-minute intervals, called regulating; and one-hour-intervals, called following. The regulating margin requirements are calculated from operational data recorded during PacifiCorp's operations from January 2012 through December 2013 (Study Term). The regulating margin requirements for load variation, and separately for load variation combined with wind variation, are then applied in the Planning and Risk (PaR) production cost model to determine the cost of the additional reserve requirements. These costs are attributed to the integration of wind generation resources in the 2015 Integrated Resource Plan (IRP).

Estimated regulating margin reserve volumes in this study were calculated using the same methodology applied in the Company's 2012 WIS²⁵, with data updated for the current Study Term. The regulating margin reserve volumes in this study account for estimated benefits from PacifiCorp's participation in the energy imbalance market (EIM) with the California Independent System Operator (CAISO). The Company expects that with its participation in the EIM future wind integration study updates will benefit as PacifiCorp gains access to additional and more specific operating data.

²² NERC Standard BAL-001-2: <http://www.nerc.com/files/BAL-001-2.pdf>

²³ NERC Standard BAL-002-WECC-2 (<http://www.nerc.com/files/BAL-002-WECC-2.pdf>), which became effective October 1, 2014, replaced NERC Standard BAL-STD-002, which was in effect at the time of this study.

²⁴ "Area Control Error" is defined in the NERC glossary here: http://www.nerc.com/pa/stand/glossary_of_terms/glossary_of_terms.pdf

²⁵ 2012 WIS report is provided as Appendix H in Volume II of the Company's 2013 IRP report: http://www.pacificorp.com/content/dam/pacificorp/doc/Energy_Sources/Integrated_Resource_Plan/2013IRP/PacifiCorp-2013IRP_Vol2-Appendices_4-30-13.pdf

Technical Review Committee

As was done for its 2012 WIS, the Company engaged a Technical Review Committee (TRC) to review the study results from the 2014 WIS. The Company thanks each of the TRC members, identified below, for their participation and professional feedback. The members of the TRC are:

- **Andrea Coon** - Director, Western Renewable Energy Generation Information System (WREGIS) for the Western Electricity Coordinating Council (WECC)
- **Matt Hunsaker** - Manager, Renewable Integration for the Western Electricity Coordinating Council (WECC)
- **Michael Milligan** - Lead research for the Transmission and Grid Integration Team at the National Renewable Energy Laboratory (NREL)
- **J. Charles Smith** - Executive Director, Utility Variable-Generation Integration Group (UVIG)
- **Robert Zavadil** - Executive Vice President of Power Systems Consulting, EnerNex

In its technical review of the Company’s 2012 WIS, the TRC made recommendations for consideration in future WIS updates.²⁶ The following table summarizes TRC recommendations from the 2012 WIS and how these recommendations were addressed in the 2014 WIS.

Table H.1 – 2012 WIS TRC Recommendations

2012 WIS TRC Recommendations	2014 WIS Response to TRC Recommendations
Reserve requirements should be modeled on an hourly basis in the production cost model, rather than on a monthly average basis.	The Company modeled reserves on an hourly basis in PaR. A sensitivity was performed to model reserves on monthly basis as in the 2012 WIS.
Either the 99.7% exceedance level should be studied parametrically in future work, or a better method to link the exceedance level, which drives the reserve requirements in the WIS, to actual reliability requirements should be developed.	In discussing this recommendation with the TRC, it was clarified that the intent was a request to better explain how the exceedance level ties to operations. PacifiCorp has included discussion in this 2014 WIS on its selection of a 99.7% exceedance level when calculating regulation reserve needs, and further clarifies that the WIS results informs the amount of regulation reserves planned for operations.
Future work should treat the categories “regulating,” “following,” and “ramping” differently by using the capabilities already in PaR and comparing these results to those using of the root-sum-of-squares (RSS) formula.	A sensitivity study was performed demonstrating the impact of separating the reserves into different categories.
Given the vast amount of data used, a simpler and more transparent analysis could be performed using a flexible statistics package rather than spreadsheets.	PacifiCorp appreciates the TRC comment; however, PacifiCorp continued to rely on spreadsheet-based calculations when calculating regulation reserves for its 2014 WIS. This allows stakeholders, who may not have access to specific statistics packages, to review work papers underlying PacifiCorp’s 2014 WIS.

²⁶ TRC’s full report is provided at:

http://www.pacificorp.com/content/dam/pacificorp/doc/Energy_Sources/Integrated_Resource_Plan/Wind_Integration/2012WIS/PacifiCorp_2012WIS_TRC-Technical-Memo_5-10-13.pdf

2012 WIS TRC Recommendations	2014 WIS Response to TRC Recommendations
Because changes in forecasted natural gas and electricity prices were a major reason behind the large change in integration costs from the 2010 WIS, sensitivity studies around natural gas and power prices, and around carbon tax assumptions, would be interesting and provide some useful results.	Changes in wind integration costs continue to align with movements in forward market prices for both natural gas and electricity. PacifiCorp describes how market prices have changed in relation to wind integration costs as updated in the 2014 WIS. With the U.S. Environmental Protection Agency’s draft rule under §111(d) of the Clean Air Act, CO ₂ tax assumptions are no longer assumed in PacifiCorp’s official forward price curves.
Although the study of separate east and west BAAs is useful, the WIS should be expanded to consider the benefits of PacifiCorp’s system as a whole, as some reserves are transferrable between the BAAs. It would be reasonable to conclude that EIM would decrease reserve requirements and integration costs.	PacifiCorp has incorporated estimated regulation reserve benefits associated with its participation in EIM in the 2014 WIS. With its involvement in EIM, future wind studies will benefit as PacifiCorp gains access to better operating data.

Executive Summary

The 2014 WIS estimates the regulating margin requirement from historical load and wind generation production data using the same methodology that was developed in the 2012 WIS. The regulating margin is required to manage variations to area control error due to load and wind variations within PacifiCorp’s BAAs. The WIS estimates the regulating margin requirement based on load combined with wind variation and separately estimates the regulating margin requirement based solely on load variation. The difference between these two calculations, with and without the estimated regulating margin required to manage wind variability and uncertainty, provides the amount of incremental regulating margin required to maintain system reliability due to the presence of wind generation in PacifiCorp’s BAAs. The resulting regulating margin requirement was evaluated deterministically in the PaR model, a production cost model used in the Company’s Integrated Resource Plan (IRP) to simulate dispatch of PacifiCorp’s system. The incremental cost of the regulating margin required to manage wind resource variability and uncertainty is reported on a dollar per megawatt-hour (\$/MWh) of wind generation basis.²⁷

When compared to the result in the 2012 WIS, which relied upon 2011 data, the 2014 WIS uses 2013 data and shows that total regulating margin increased by approximately 27 megawatts (MW) in 2012 and 47 MW in 2013. These increases in the total reserve requirement reflect different levels of volatility in actual load and wind generation. This volatility in turn impacts the operational forecasts and the deviations between the actual and operational forecast reserve requirements, which ultimately drives the amount of regulating margin needed. Table H.2 depicts the combined PacifiCorp BAA annual average regulating margin calculated in the 2014 WIS, and separates the regulating margin due to load from the regulating margin due to wind. The total regulating margin increased from 579 MW in the 2012 WIS to 626 MW in the 2014 WIS.

²⁷ The PaR model can be run with stochastic variables in Monte Carlo simulation mode or in deterministic mode whereby variables such as natural gas and power prices do not reflect random draws from probability distributions. For purposes of the WIS, the intention is not to evaluate stochastic portfolio risk, but to estimate production cost impacts of incremental operating reserves required to manage wind generation on the system based on current projections of future market prices for power and natural gas.

Table H.2 – Average Annual Regulating Margin Reserves, 2011 – 2013 (MW)

Year	Type	West BAA	East BAA	Combined
2011 (2012 WIS)	Load-Only Regulating Margin	147	247	394
	Incremental Wind Regulating Margin	54	131	185
	Total Regulating Margin	202	378	579
	Wind Capacity	589	1,536	2,126
2012	Load-Only Regulating Margin	141	259	400
	Incremental Wind Regulating Margin	77	129	206
	Total Regulating Margin	217	388	606
	Wind Capacity	785	1,759	2,543
2013 (2014 WIS)	Load-Only Regulating Margin	166	275	441
	Incremental Wind Regulating Margin	55	130	186
	Total Regulating Margin	222	405	626
	Wind Capacity	785	1,759	2,543

Table H.3 lists the cost to integrate wind generation in PacifiCorp’s BAAs. The cost to integrate wind includes the cost of the incremental regulating margin reserves to manage intra-hour variances (as outlined above) and the cost associated with day-ahead forecast variances, the latter of which affects how dispatchable resources are committed to operate, and subsequently, affect daily system balancing. Each of these component costs were calculated using the PaR model. A series of PaR simulations were completed to isolate each wind integration cost component by using a “with and without” approach. For instance, PaR was first used to calculate system costs solely with the regulating margin requirement due to load variations, and then again with the increased regulating margin requirements due to load combined with wind generation. The change in system costs between the two PaR simulations results in the wind integration cost.

Table H.3 – Wind Integration Cost, \$/MWh

	2012 WIS (2012\$)	2014 WIS (2015\$)
Intra-hour Reserve	\$2.19	\$2.35
Inter-hour/System Balancing	\$0.36	\$0.71
Total Wind Integration	\$2.55	\$3.06

The 2014 WIS results are applied in the 2015 IRP portfolio development process as part of the costs of wind generation resources. In the portfolio development process using the System Optimizer (SO) model, the wind integration cost on a dollar per megawatt-hour basis is included as a cost to the variable operation and maintenance cost of each wind resource. Once candidate resource portfolios are developed using the SO model, the PaR model is used to evaluate the risk profiles of the portfolios in meeting load obligations, including incremental operating reserve needs. Therefore, when performing IRP risk analysis using PaR, specific operating reserve requirements consistent with this wind study are used.

Data

The calculation of regulating margin reserve requirement was based on actual historical load and wind production data over the Study Term from January 2012 through December 2013. Table H.4 outlines the load and wind generation 10-minute interval data used during the Study Term.

Table H.4 – Historical Wind Production and Load Data Inventory

	Wind Nameplate Capacity (MW)	Beginning of Data	End of Data	BAA
Wind Plants within PacifiCorp BAAs				
Chevron Wind	16.5	1/1/2012	12/31/2013	East
Combine Hills	41.0	1/1/2012	12/31/2013	West
Dunlap 1 Wind	111.0	1/1/2012	12/31/2013	East
Five Pine and North Point	119.7	12/1/2012	12/31/2013	East
Foot Creek Generation	85.1	1/1/2012	12/31/2013	East
Glenrock III Wind	39.0	1/1/2012	12/31/2013	East
Glenrock Wind	99.0	1/1/2012	12/31/2013	East
Goodnoe Hills Wind	94.0	1/1/2012	12/31/2013	West
High Plains Wind	99.0	1/1/2012	12/31/2013	East
Leaning Juniper 1	100.5	1/1/2012	12/31/2013	West
Marengo I	140.4	1/1/2012	12/31/2013	West
Marengo II	70.2	1/1/2012	12/31/2013	West
McFadden Ridge Wind	28.5	1/1/2012	12/31/2013	East
Mountain Wind 1 QF	60.9	1/1/2012	12/31/2013	East
Mountain Wind 2 QF	79.8	1/1/2012	12/31/2013	East
Power County North and Power County South	45.0	1/1/2012	12/31/2013	East
Oregon Wind Farm QF	64.6	1/1/2012	12/31/2013	West
Rock River I	49.0	1/1/2012	12/31/2013	East
Rolling Hills Wind	99.0	1/1/2012	12/31/2013	East
Seven Mile Wind	99.0	1/1/2012	12/31/2013	East
Seven Mile II Wind	19.5	1/1/2012	12/31/2013	East
Spanish Fork Wind 2 QF	18.9	1/1/2012	12/31/2013	East
Stateline Contracted Generation	175.0	1/1/2012	12/31/2013	West
Three Buttes Wind	99.0	1/1/2012	12/31/2013	East
Top of the World Wind	200.2	1/1/2012	12/31/2013	East
Wolverine Creek	64.5	1/1/2012	12/31/2013	East
Long Hollow Wind		1/1/2012	12/31/2013	East
Campbell Wind		1/1/2012	12/31/2013	West
Horse Butte		6/19/2012	12/31/2013	East
Jolly Hills 1		1/1/2012	12/31/2013	East
Jolly Hills 2		1/1/2012	12/31/2013	East
Load Data				
PACW Load	n/a	1/1/2012	12/31/2013	West
PACE Load	n/a	1/1/2012	12/31/2013	East

Historical Load Data

Historical load data for the PacifiCorp east (PACE) and PacifiCorp west (PACW) BAAs were collected for the Study Term from the PacifiCorp PI system.²⁸ The raw load data were reviewed for anomalies prior to further use. Data anomalies can include:

- Incorrect or reversal of sign (recorded data switching from positive to negative);
- Significant and unexplainable changes in load from one 10-minute interval to the next;
- Excessive load values.

After reviewing 210,528 10-minute load data points in the 2014 WIS, 1,011 10-minute data points, roughly 0.5% of the data, were identified as irregular. Since reserve demand is created by unexpected changes from one time interval to the next, the corrections made to those data points were intended to mitigate the impacts of irregular data on the calculation of the reserve requirements and costs in this study.

Of the 1,011 load data points requiring adjustment, 984 exhibited unduly long periods of unchanged or “stuck” values. The data points were compared to the values from the Company’s official hourly data. If the six 10-minute PI values over a given hour averaged to a different value than the official hourly record, they were replaced with six 10-minute instances of the hourly value. For example, if PACW’s measured load was 3,000 MW for three days, while the Company’s official hourly record showed different hourly values for the same period, the six 10-minute “stuck” data points for an hour were replaced with six instances of the value from the official record for the hour. Though the granularity of the 10-minute readings was lost, the hour-to-hour load variability over the three days in this example would be captured by this method. In total, the load data requiring replacement for stuck values represented only 0.47% of the load data used in the current study.

The remaining 27 of data points requiring adjustment were due to questionable load values, three of which were significantly higher than the load values in the adjacent time intervals, and 24 of which were significantly lower. While not necessarily higher or lower by an egregious amount in each instance, these specific irregular data collectively averaged a difference of several hundred megawatts from their replacement values. Table H.5 depicts a sample of the values that varied significantly, as compared to the data points immediately prior to and after those 10-minute intervals. The replacement values, calculated by interpolating the prior value and the successive 10-minute period to form a straight line, are also shown in the table.

²⁸ The PI system collects load and generation data and is supplied to PacifiCorp by OSISoft. The Company Web site is http://www.osisoft.com/software-support/what-is-pi/what_is_PI_.aspx.

Table H.5 – Examples of Load Data Anomalies and their Interpolated Solutions

Time	Original Load Value (MW)	Final Load Value (MW)	Method to Calculate Final Load Value
1/5/2012 12:20	5,805	5,805	n/a
1/5/2012 12:30	5,211	5,793	12:20 + 1/5 of (13:10 minus 12:20)
1/5/2012 12:40	5,074	5,781	12:20 + 2/5 of (13:10 minus 12:20)
1/5/2012 12:50	5,063	5,769	12:20 + 3/5 of (13:10 minus 12:20)
1/5/2012 13:00	5,465	5,756	12:20 + 4/5 of (13:10 minus 12:20)
1/5/2012 13:10	5,744	5,744	n/a
5/6/2013 8:50	5,651	5,651	n/a
5/6/2013 9:00	4,583	5,694	Average of 8:50 and 9:10
5/6/2013 9:10	5,737	5,737	n/a

Historical Wind Generation Data

Over the Study Term, 10-minute interval wind generation data were available for the wind projects as summarized in Table H.4. The wind output data were collected from the PI system.

In 2011 the installed wind capacity in the PacifiCorp system was 589 MW in the west BAA and 1,536 MW in the east BAA. For 2012 and 2013, these capacities increased to 785 MW and 1,759 MW in the west and east BAAs, respectively. The increases were the result of 195 MW of existing wind projects transferring from Bonneville Power Administration (BPA) to PacifiCorp's west BAA, and 222 MW of new third party wind projects coming on-line during 2012 in the east BAA.

Figure H.1 shows PacifiCorp owned and contracted wind generation plants located in PacifiCorp's east and west BAAs. The third-party wind plants located within PacifiCorp's BAAs which the Company does not purchase generation from or own are not depicted in this figure.

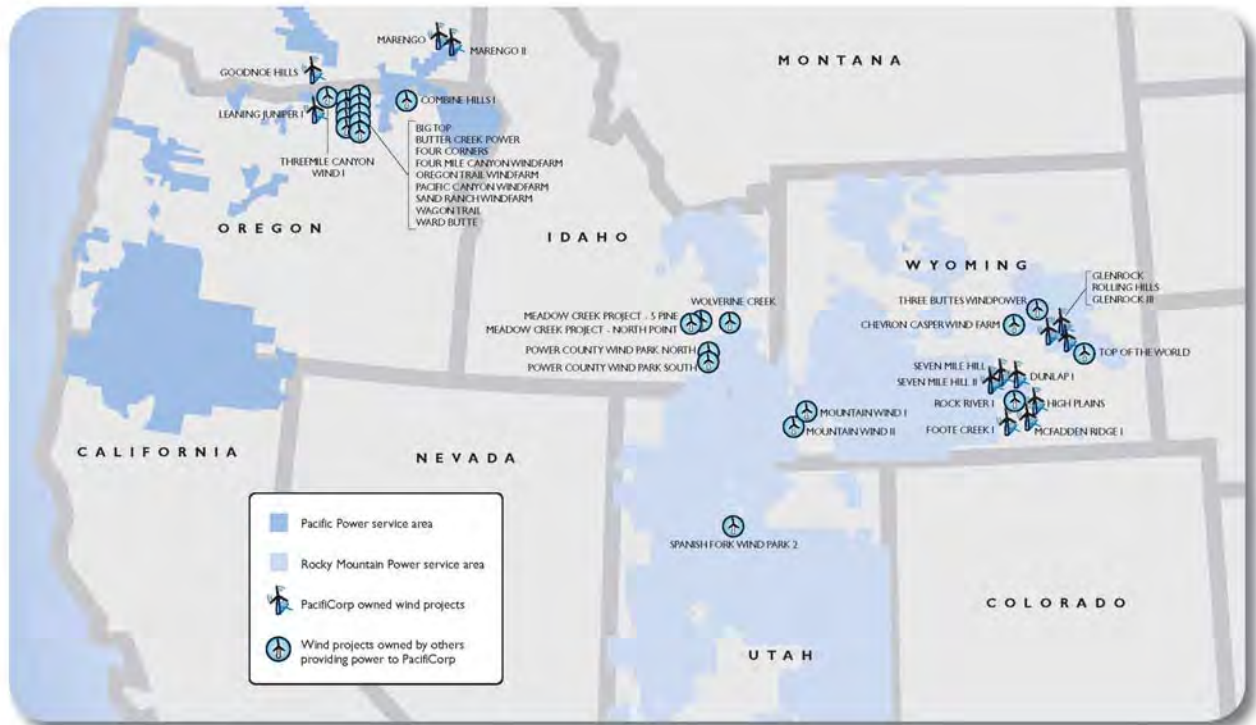
Figure H.1 – Representative Map, PacifiCorp Wind Generating Stations Used in this Study

The wind data collected from the PI system is grouped into a series of sampling points, or nodes, which represent generation from one or more wind plants. In consideration of occasional irregularities in the system collecting the data, the raw wind data was reviewed for reasonableness considering the following criteria:

- Incorrect or reversal of sign (recorded data switching from positive to negative);
- Output greater than expected wind generation capacity being collected at a given node;
- Wind generation appearing constant over a period of days or weeks at a given node.

Some of the PI system data exhibited large negative generation output readings in excess of the amount that could be attributed to station service. These meter readings often reflected positive generation and a reversed polarity on the meter rather than negative generation. In total, only 38 of 3,822,048 10-minute PI readings, representing 0.001% of the wind data used in this WIS, required substituting a positive value for a negative generation value.

Some of the PI system data exhibited large positive generation output readings in excess of plant capacity. In these instances, the erroneous data were replaced with a linear interpolation between the value immediately before the start of the excessively large data point and the value immediately after the end of the excessively large data point. In total, only 49 10-minute PI readings, representing 0.002% of the wind data used in this WIS, required substituting a linear interpolation for an excessively large generation value.

Similar to the load data, the PI system wind data also exhibited patterns of unduly long periods of unchanged or “stuck” values for a given node. To address these anomalies, the 10-minute PI values were compared to the values from the Company’s official hourly data, and if the six 10-minute PI values over a given hour averaged to a different value than the official hourly record,

they were replaced with six 10-minute instances of the hourly value. For example, if a node's measured wind generation output was 50 MW for three weeks, while the official record showed different hourly values for the same time period, the six 10-minute "stuck" data points for an hour were replaced with six instances of the value from the official record for the hour. Though the granularity of the 10-minute readings was lost, the hour-to-hour wind variability over the three weeks in this example would be captured by this method. In total, the wind generation data requiring replacement for stuck values represented only 0.2% of the wind data used in the WIS.

Methodology

Method Overview

This section presents the approach used to establish regulating margin reserve requirements and the method for calculating the associated wind integration costs. 10-minute interval load and wind data were used to estimate the amount of regulating margin reserves, both up and down, in order to manage variation in load and wind generation within PacifiCorp's BAAs.

Operating Reserves

NERC regional reliability standard BAL-002-WECC-2 requires each BAA to carry sufficient operating reserve at all times.²⁹ Operating reserve consists of contingency reserve and regulating margin. These reserve requirements necessitate committing generation resources that are sufficient to meet not only system load but also reserve requirements. Each of these types of operating reserve is further defined below.

Contingency reserve is capacity that the Company holds in reserve that can be used to respond to contingency events on the power system, such as an unexpected outage of a generator or a transmission line. Contingency reserve may not be applied to manage other system fluctuations such as changes in load or wind generation output. Therefore, this study focuses on the operating reserve component to manage load and wind generation variations which is incremental to contingency reserve, which is referred to as regulating margin.

Regulating margin is the additional capacity that the Company holds in reserve to ensure it has adequate reserve at all times to meet the NERC Control Performance Criteria in BAL-001-2, which requires a BAA to carry regulating reserves incremental to contingency reserves to maintain reliability.³⁰ However, these additional regulating reserves are not defined by a simple formula, but rather are the amount of reserves required by each BAA to meet the control performance standards. NERC standard BAL-001-2, called the Balancing Authority Area Control Error Limit (BAAL), allows a greater ACE during periods when the ACE is helping frequency. However, the Company cannot plan on knowing when the ACE will help or exacerbate frequency so the L_{10} is used for the bandwidth in both directions of the ACE.^{31,32} Thus the Company determines, based on the unique level of wind and load variation in its

²⁹ NERC Standard BAL-002-WECC-2: <http://www.nerc.com/files/BAL-002-WECC-2.pdf>

³⁰ NERC Standard BAL-001-2: <http://www.nerc.com/files/BAL-001-2.pdf>

³¹ The L_{10} represents a bandwidth of acceptable deviation prescribed by WECC between the net scheduled interchange and the net actual electrical interchange on the Company's BAAs. Subtracting the L_{10} credits customers with the natural buffering effect it entails.

³² The L_{10} of PacifiCorp's balancing authority areas are 33.41MW for the West and 47.88 MW for the East. For more information, please refer to:

<http://www.wecc.biz/committees/StandingCommittees/OC/OPS/PWG/Shared%20Documents/Annual%20Frequency%20Bias%20Settings/2012%20CPS2%20Bounds%20Report%20Final.pdf>

system, and the prevailing operating conditions, the unique level of incremental operating reserve it must carry. This reserve, or regulating margin, must respond to follow load and wind changes throughout the delivery hour. For this WIS, the Company further segregates regulating margin into two components: ramp reserve and regulation reserve.

Ramp Reserve: Both load and wind change from minute-to-minute, hour-to-hour, continuously at all times. This variability requires ready capacity to follow changes in load and wind continuously, through short deviations, at all times. Treating this variability as though it is perfectly known (as though the operator would know exactly what the net balancing area load would be a minute from now, 10-minutes from now, and an hour from now) and allowing just enough generation flexibility on hand to manage it defines the ramp reserve requirement of the system.

Regulation Reserve: Changes in load or wind generation which are not considered contingency events, but require resources be set aside to meet the needs created when load or wind generation change unexpectedly. The Company has defined two types of regulation reserve – regulating and following reserves. Regulating reserve are those covering short term variations (moment to moment using automatic generation control) in system load and wind. Following reserves cover uncertainty across an hour when forecast changes unexpectedly.

To summarize, regulating margin represents operating reserves the Company holds over and above the mandated contingency reserve requirement to maintain moment-to-moment system balance between load and generation. The regulating margin is the sum of two parts: ramp reserve and regulation reserve. The ramp reserve represents an amount of flexibility required to follow the change in actual net system load (load minus wind generation output) from hour to hour. The regulation reserve represents flexibility maintained to manage intra-hour and hourly forecast errors about the net system load, and consists of four components: load and wind following and load and wind regulating.

Determination of Amount and Costs of Regulating Margin Requirements

Regulating margin requirements are calculated for each of the Company's BAAs from production data via a five step process, each described in more detail later in this section. The five steps include:

1. Calculation of the ramp reserve from the historical data (with and without wind generation).
2. Creation of hypothetical forecasts of following and regulating needs from historical load and wind production data.
3. Recording differences, or deviations, between actual wind generation and load values in each 10-minute interval of the study term and the expected generation and load.
4. Group these deviations into bins that can be analyzed for the reserve requirement per forecast value of wind and load, respectively, such that a specified percentage (or tolerance level) of these deviations would be covered by some level of operating reserves.
5. The reserve requirements noted for the various wind and load forecast values are then applied back to the operational data enabling an average reserve requirement to be calculated for any chosen time interval within the Study Term.

Once the amount of regulating margin is estimated, the cost of holding the specified reserves on PacifiCorp's system is estimated using the PaR model. In addition to using PaR for evaluating

operating reserve cost, the PaR model is also used to estimate the costs associated with daily system balancing activities. These system balancing costs result from the unpredictable nature of load and wind generation on a day-ahead basis and can be characterized as system costs borne from committing generation resources against a forecast of load and wind generation and then dispatching generation resources under actual load and wind conditions as they occur in real time.

Regulating Margin Requirements

Consistent with the methodology developed in the Company's 2012 WIS, and the discussion above, regulating margin requirements were derived from actual data on a 10-minute interval basis for both wind generation and load. The ramp reserve represents the minimal amount of flexible system capacity required to follow net load requirements without any error or deviation and with perfect foresight for following changes in load and wind generation from hour to hour. These amounts are as follows:

- If system is ramping down: $[(\text{Net Area Load Hour } H - \text{Net Area Load Hour } (H+1))/2]$
- If system is ramping up: $[(\text{Net Area Load Hour } (H+1) - \text{Net Area Load Hour } H)/2]$

That is, the ramp reserve is half the absolute value of the difference between the net balancing area load at the top of one hour minus the net balancing load at the top of the prior hour.

The ramp reserve for load and wind is calculated using the net load (load minus wind generation output) at the top of each hour. The ramp reserve required for wind is the difference between that for load and that for load and wind.

As ramp reserves represent the system flexibility required to follow the system's requirements without any uncertainty or error, the regulation reserve is necessary to cover uncertainty ever-present in power system operations. Very short-term fluctuations in weather, load patterns, wind generation output and other system conditions cause short term forecasts to change at all times. Therefore, system operators rely on regulation reserve to allow for the unpredictable changes between the time the schedule is made for the next hour and the arrival of the next hour, or the ability to follow net load. Also, these very same sources of instability are present throughout each hour, requiring flexibility to regulate the generation output to the myriad of ups and downs of customer demand, fluctuations in wind generation, and other system disturbances. To assess the regulation reserve requirements for PacifiCorp's BAAs, the Company compared operational data to hypothetical forecasts as described below.

Hypothetical Operational Forecasts

Regulation reserve consists of two components: (1) regulating, which is developed using the 10-minute interval data, and (2) following, which is calculated using the same data but estimated on an hourly basis. Load data and wind generation data were applied to estimate reserve requirements for each month in the Study Term. The regulating calculation compares observed 10-minute interval load and wind generation to a 10-minute interval forecast, and following compares observed hourly averages to an average hourly forecast. Therefore, the regulation reserve requirements are composed of four component requirements, which, in turn, depend on differences between actual and expected needs. The four component requirements include: load following, wind following, load regulating, and wind regulating. The determination of these

reserve requirements began with the development of the expected following and regulating needs (hypothetical forecasts) of the four components, each discussed in turn below.

Hypothetical Load Following Operational Forecast

PacifiCorp maintains system balance by optimizing its operations to an hour-ahead load forecast every hour with changes in generation and market activity. This planning interval represents hourly changes in generation that are assessed roughly 20 minutes into each hour to meet a bottom-of-the-hour (i.e., 30 minutes after the hour) scheduling deadline. Taking into account the conditions of the present and the expected load and wind generation, PacifiCorp must schedule generation to meet demand with an expectation of how much higher or lower load may be. These activities are carried out by the group referred to as the real-time desk.

PacifiCorp's real-time desk updates the load forecast for the upcoming hour 40 minutes prior to the start of that hour. This forecast is created by comparing the load in the current hour to the load of a prior similar-load-shaped day. The hour-to-hour change in load from the similar day and hours (the load difference or “delta”) is applied to the load for the current hour, and the sum is used as the forecast for the upcoming hour. For example, on a given Sunday, the PacifiCorp real-time desk operator may forecast hour-to-hour changes in load by referencing the hour-to-hour changes from the prior Sunday, which would be a similar-load-shaped day. If at 11:20 am, the hour-to-hour load change between 11:00 a.m. and 12:00 p.m. of the prior Sunday was five percent, the operator will use a five percent change from the current hour to be the upcoming hour's load following forecast.

For the calculation in this WIS, the hour-ahead load forecast used for calculating load following was modeled using the approximation described above with a shaping factor calculated using the day from one week prior, and applying a prior Sunday to shape any NERC holiday schedules. The differences observed between the actual hourly load and the load following forecasts comprised the load following deviations.

Figure H.2 shows an illustrative example of a load following deviation in August 2013 using operational data from PACE. In this illustration, the delta between hours 11:00 a.m. and 12:00 p.m. from the prior week is applied to the actual load at 11:00 a.m. on the “current day” to produce the hypothetical forecast of the load for the 12:00 p.m. (“upcoming”) hour. That is, using the actual load at 11:00 a.m. (beginning of the purple line), the load forecast for the 12:00 p.m. hour is calculated by following the dashed red line that is parallel to the green line from the prior week. The forecasted load for the upcoming hour is the point on the blue line at 12:00 p.m. Since the actual load for the 12:00 p.m. hour (the point on the purple line at 12:00 p.m.) is higher than the forecast, the deviation (indicated by the black arrow) is calculated as the difference between the forecasted and the actual load for 12:00 p.m. This deviation is used to calculate the load following component reserve requirement for 12:00 p.m.

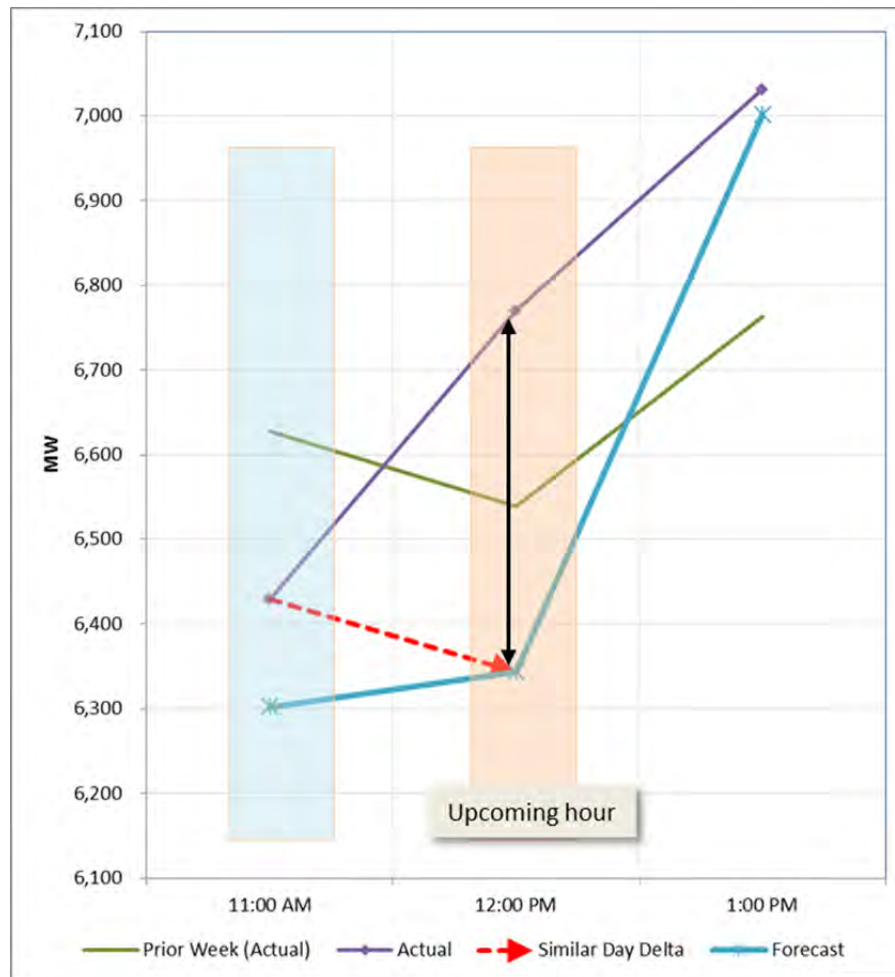
Figure H.2 – Illustrative Load Following Forecast and Deviation

Hypothetical Wind Following Operational Forecast

The short term hourly operational wind forecast is based on the concept of persistence – using the instantaneous sample of the wind generation output at 20 minutes into the current hour as the forecast for the upcoming hour, and balancing the system to that forecast.

For the calculation in this WIS, the hour-ahead wind generation forecast for the “upcoming” hour used the 20th minute output from the “current” hour. For example, if the wind generation is producing 300 MW at 9:20 p.m. in PACE, then it is assumed that 300 MW will be generated between 10:00 p.m. and 11:00 p.m., that same day. The difference between the hourly average of the six 10-minute wind generation readings and the wind generation forecast comprised the wind following deviation for that hour.

Figure H.3 shows an illustrative example of a wind following deviation in July 2013 using operational data from PACE. In this illustration, the wind generation output at 9:20 p.m. (within the “current” hour) is the hour-ahead forecast of the wind generation for the 10:00 p.m. hour (the “upcoming” hour). That is, following persistence scheduling, the wind following need for the 10:00 p.m. hour is calculated by following the dashed red line starting from the actual wind generation on the purple line at 9:20 p.m. for the entire 10:00 p.m. hour (blue line). Since the average of the actual wind generation during the 10:00 p.m. hour (dotted green line) is higher than the wind following forecast, the deviation (indicated by the black arrow) is calculated as the

difference between the wind following forecast and the actual wind generation for the 10:00 p.m. hour. This deviation is used to calculate the wind following component reserve requirement for 10:00 p.m.

Figure H.3 – Illustrative Wind Following Forecast and Deviation

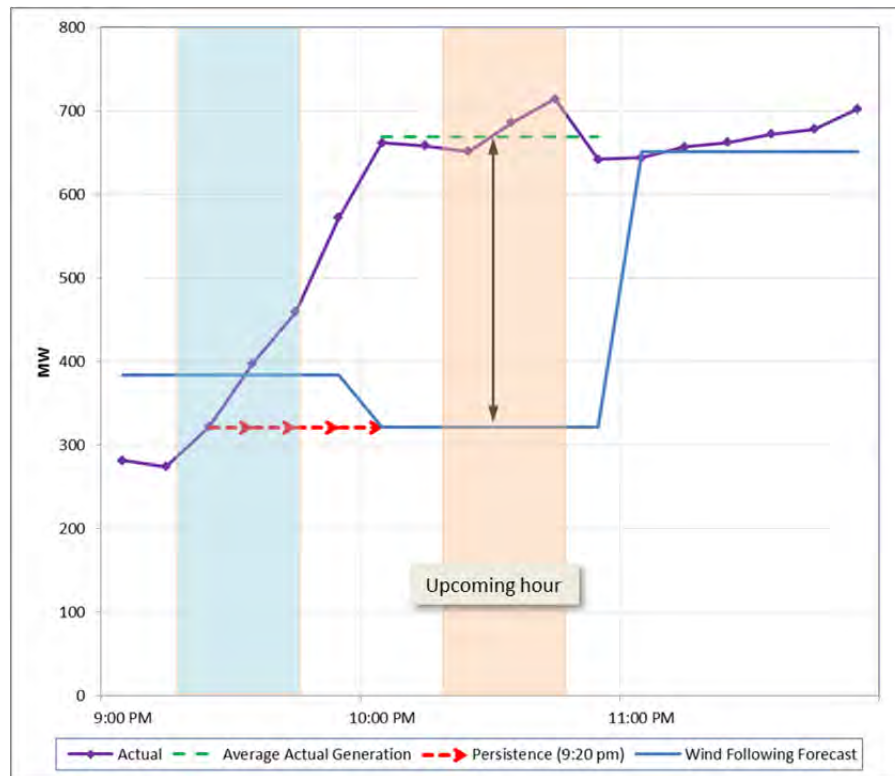

Hypothetical Load Regulating Operational Forecast

Separate from the variations in the hourly scheduled loads, the 10-minute load variability and uncertainty was analyzed by comparing the 10-minute actual load values to a line of intended schedule, represented by a line interpolated between the actual load at the top of the “current” hour and the hour-ahead forecasted load (the load following hypothetical forecast) at the bottom of the “upcoming” hour. The method approximates the real time operations process for each hour where, at the top of a given hour, the actual load is known, and a forecast for the next hour has been made.

For the calculation in this WIS, a line joining the two points represented a ramp up or down expected within the given hour. The actual 10-minute load values were compared to the portion of this straight line from the “current” hour to produce a series of load regulating deviations at each 10-minute interval within the “current” hour.

Figure H.4 shows an illustrative example of a load regulating deviation in November 2013 using operational data in PACW. In this illustration, the line of intended schedule is drawn from the actual load at 7:00 a.m. to the hour-ahead load forecast at 8:30 a.m. The portion of this line within the 7:00 a.m. hour becomes the load regulating forecast for that hour. That is, using the forecasted load for the 8:00 a.m. hour that was calculated for the load following hypothetical forecast, the line of intended schedule is calculated by following the dashed red line from the actual load at 7:00 a.m. (beginning of the purple line) to the point in the hour-ahead forecast

(green line) at 8:30 a.m. The six 10-minute deviations within the 7:00 a.m. hour (one of which is indicated by the black arrow) are the differences between the actual 10-minute load readings (purple line) and the line of intended schedule. These deviations are used to calculate the load regulating component reserve requirement for the six 10-minute intervals within the 7:00 a.m. hour.

Figure H.4 – Illustrative Load Regulating Forecast and Deviation

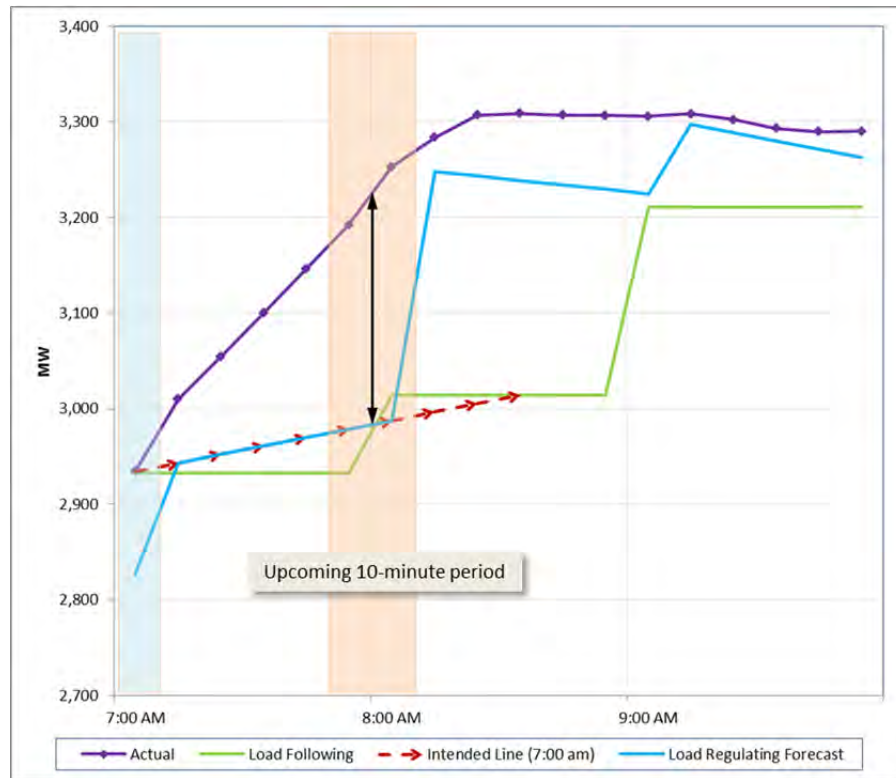

Hypothetical Wind Regulating Operational Forecast

Similarly, the 10-minute wind generation variability and uncertainty was analyzed by comparing the 10-minute actual wind generation values to a line of intended schedule, represented by a line interpolated between the actual wind generation at the top of the “current” hour and the hour-ahead forecasted wind generation (the wind following hypothetical forecast) at the bottom of the “upcoming” hour.

For the calculation in this WIS, a line joining the two points represented a ramp up or down expected within the given hour. The actual 10-minute wind generation values were compared to the portion of this straight line from the “current” hour to produce a series of wind regulating deviations at each 10-minute interval within the “current” hour.

Figure H.5 shows an illustrative example of a wind regulating deviation in July 2013 using operational data in PACE. In this illustration, the line of intended schedule is drawn from the actual wind generation at 2:00 p.m. to the hour-ahead wind forecast at 3:30 p.m. The portion of this line within the 2:00 p.m. hour becomes the wind regulating forecast for that hour. That is, using the forecasted wind generation for the 3:00 p.m. hour that was calculated for the wind following hypothetical forecast, the line of intended schedule is calculated by following the dashed red line from the actual wind generation at 2:00 p.m. (beginning of the purple line) to the point in the hour-ahead forecast (green line) at 3:30 p.m. The six 10-minute deviations within the

2:00 p.m. hour (one of which is indicated by the black arrow) are the differences between the actual 10-minute wind generation readings (purple line) and the line of intended schedule (red line). These deviations are used to calculate the wind regulating component reserve requirement for the six 10-minute intervals within the 2:00 p.m. hour.

Figure H.5 – Illustrative Wind Regulating Forecast and Deviation

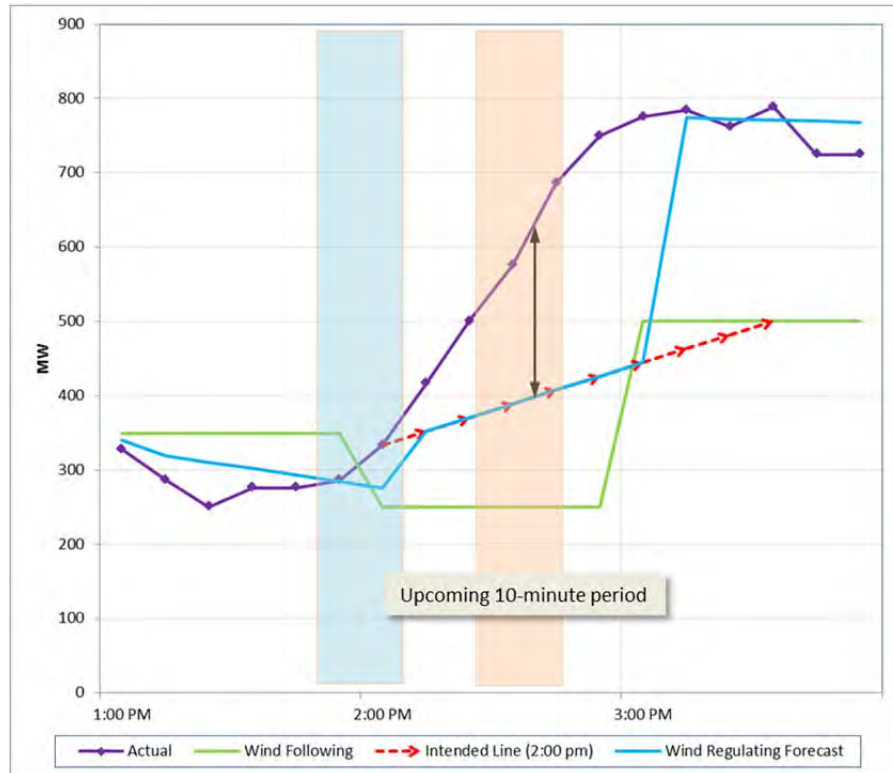

Analysis of Deviations

The deviations are calculated for each 10-minute interval in the Study Term and for each of the four components of regulation reserves (load following, wind following, load regulating, wind regulating). Across any given hourly time interval, the six 10-minute intervals within each hour have a common following deviation, but different regulating deviations. For example, considering load deviations only, if the load forecast for a given hour was 150 MW below the actual load realized in that hour, then a load following deviation of -150 MW would be recorded for all six of the 10-minute periods within that hour. However, as the load regulating forecast and the actual load recorded in each 10-minute interval vary, the deviations for load regulating vary. The same holds true for wind following and wind regulating deviations, in that the following deviation is recorded as equal for the hour, and the regulating deviation varies each 10-minute interval.

Since the recorded deviations represent the amount of unpredictable variation on the electrical system, the key question becomes how much regulation reserve to hold in order to cover the deviations, thereby maintaining system reliability. The deviations are analyzed by separating the deviations into bins by their characteristic forecasts for each month in the Study Term. The bins are defined by every 5th percentile of recorded forecasts, creating 20 bins for the deviations in each month for each component hypothetical operational forecast. In other words, each month of the Study Term has 20 bins of load following deviations, 20 bins of load regulating deviations, and the same for wind following and wind regulating.

As an example, Table H.6 depicts the calculation of percentiles (every five percent) among the load regulating forecasts for June 2013 using PACE operational data. For the month, the load ranged from 4,521 MW to 8,587 MW. A load regulating forecast for a load at 4,892 MW represents the fifth percentile of the forecasts for that month. Any forecast below that value will be in Bin 20, along with the respective deviations recorded for those time intervals. Any forecast values between 4,892 MW and 5,005 MW will place the deviation for that particular forecast in Bin 19.

Table H.6 – Percentiles Dividing the June 2013 East Load Regulating Forecasts into 20 Bins

Bin Number	Percentile	Load Forecast
	MAX	8,587
1	0.95	7,869
2	0.90	7,475
3	0.85	7,220
4	0.80	6,984
5	0.75	6,807
6	0.70	6,621
7	0.65	6,482
8	0.60	6,383
9	0.55	6,285
10	0.50	6,158
11	0.45	6,023
12	0.40	5,850
13	0.35	5,720
14	0.30	5,568
15	0.25	5,404
16	0.20	5,275
17	0.15	5,134
18	0.10	5,005
19	0.05	4,892
20	MIN	4,521

Table H.7 depicts an example of how the data are assigned into bins based on the level of forecasted load, following the definition of the bins in Table H.6.

Table H.7 – Recorded Interval Load Regulating Forecasts and their Respective Deviations for June 2013 Operational Data from PACE

Date / Time	Load Regulation Forecast	Load Regulation Deviation	Bin Assignment
06/01/2013 6:00	4,755	88	20
06/01/2013 6:10	4,706	-67	20
06/01/2013 6:20	4,746	-13	20
06/01/2013 6:30	4,786	-36	20
06/01/2013 6:40	4,826	-26	20
06/01/2013 6:50	4,866	-46	20
06/01/2013 7:00	4,905	-46	19
06/01/2013 7:10	4,984	4	19
06/01/2013 7:20	5,016	-8	18
06/01/2013 7:30	5,048	-10	18
06/01/2013 7:40	5,081	16	18
06/01/2013 7:50	5,113	31	18
06/01/2013 8:00	5,145	12	17
06/01/2013 8:10	5,158	16	17
06/01/2013 8:20	5,182	-22	17
06/01/2013 8:30	5,207	-6	17
06/01/2013 8:40	5,231	4	17
06/01/2013 8:50	5,256	18	17
06/01/2013 9:00	5,280	10	16
06/01/2013 9:10	5,278	-30	16
06/01/2013 9:20	5,287	11	16
06/01/2013 9:30	5,295	2	16
06/01/2013 9:40	5,303	25	16
06/01/2013 9:50	5,311	-4	16

The binned approach prevents over-assignment of reserves in different system states, owing to certain characteristics of load and wind generation. For example, when the balancing area load is near the lowest value for any particular day, it is highly unlikely the load deviation will require substantial down reserves to maintain balance because load will typically drop only so far. Similarly, when the load is near the peak of the load values in a month, it is likely to go only a little higher, but could drop substantially at any time. Similarly for wind, when wind generation output is at the peak value for a system, there will not be a deviation taking the wind value above that peak. In other words, the directional nature of reserve requirements can change greatly by the state of the load or wind output. At high load or wind generation states, there is not likely to be a significant need for reserves covering a surprise increase in those values. Similarly, at the lowest states, there is not likely to be a need for the direction of reserves covering a significant shortfall in load or wind generation.

Figure H.6 shows a distribution of deviations gathered in Bin 14 for forecast load levels between 5,569 MW and 5,720 MW in June 2013. All of the deviations fall between -170 MW and +370 MW. Such deviations would need to be met by resources on the system in order to maintain the balance of load and resources. That is, when actual load is 170 MW lower than expected, there needs to be additional resources that are capable of being dispatched down, and when actual load is 370 MW higher than expected, there needs to be additional resources that are capable of being dispatched up to cover the increases in load.

Figure H.6 – Histogram of Deviations Occurring About a June 2013 PACE Load Regulating Forecast between 5,568 MW and 5,720 MW (Bin 14)

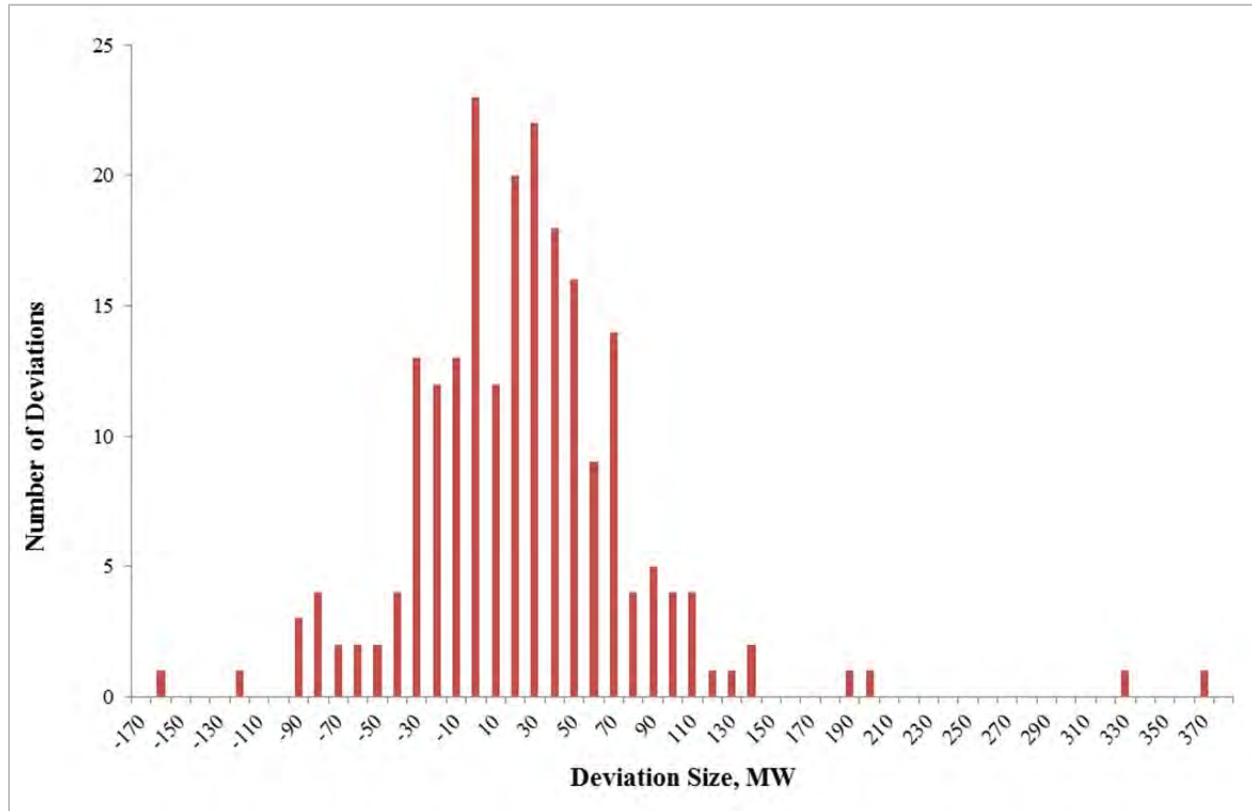

Up and down deviations must be met by operating reserves. To determine the amount of reserves required for load or wind generation levels in a bin, a tolerance level is applied to exclude deviation outliers. The bin tolerance level represents a percentage of component deviations intended to be covered by the associated component reserve. In the absence of an industry standard which articulates an acceptable level of tolerance, the Company must choose a guideline that provides both cost-effective and adequate reserves. These two criteria work against each other, whereby assigning an overly-stringent tolerance level will lead to unreasonably high wind integration costs, while an overly-lax tolerance level incurs penalties for violating compliance standards. Two relevant standards, CPS1 and BAAL, address the reliability of control area frequency and error. The compliance standard for CPS1 (rolling 12-month average of area frequency) is 100%, while the minimum compliance standard for BAAL is a 30-minute response. Working within these bounds and considering the requirement to maintain adequate, cost-effective reserves, the Company plans to a three-standard deviation (99.7 percent) tolerance in the calculation of component reserves, which are subsequently used to inform the need for regulating margin reserves in operations. In doing so, the Company strikes a balance between planning for as much deviation as allowable while managing costs, uncertainty, adequacy and reliability. Despite exclusion of extreme deviations with the use of the 99.7 percent tolerance, the Company's system operators are expected to meet reserve requirements without exception.

The binned approach is applied on a monthly basis, and results in the four component forecast values (load following, wind following, load regulating, wind regulating) for each 10-minute interval of the Study Period. The component forecasts and reserve requirements are then applied

back to the operational data to develop summary level information for regulation reserve requirements, using the back casting procedure described below.

Back Casting

Given the development of component reserve requirements that are dependent upon a given system state, reserve requirements were assigned to each 10-minute interval in the Study Term according to their respective hypothetical operational forecasts to simulate the component reserves values as they would have happened in real-time operations. Doing so results in a total reserve requirement for each interval informed by the data.

To perform the back casts, component reserve requirements calculated from the bin analysis described above are first turned into reference tables. Table H.8 shows a sample (June 2013, PACE) reference table for load and wind following reserves at varying levels of forecasted load and wind generation, and Table H.9 shows a sample (June 2013, PACE) reference table for load and wind regulating reserves at varying forecast levels.

Table H.8 – Sample Reference Table for East Load and Wind Following Component Reserves (MW)

Bin	Up Reserve (MW)	Load Forecast (MW)	Down Reserve (MW)	Up Reserve (MW)	Wind Forecast (MW)	Down Reserve (MW)
	266	10000	283	358	5000	157
1	266	7841	283	358	1061	157
2	250	7528	192	348	940	213
3	200	7220	285	512	839	205
4	315	7005	294	298	755	290
5	262	6804	334	356	698	207
6	150	6626	321	198	627	231
7	280	6506	260	239	571	375
8	191	6381	212	332	502	308
9	147	6265	135	238	438	284
10	273	6168	99	195	395	374
11	237	6017	168	163	355	172
12	199	5859	338	166	302	241
13	279	5719	295	115	262	264
14	124	5574	151	114	226	203
15	87	5406	195	101	197	287
16	144	5264	171	84	163	326
17	179	5125	98	90	122	225
18	102	4991	86	44	78	242
19	87	4870	73	35	47	288
20	290	4505	63	41	-7	81
	290	0	63	41	-7	81

Table H.9 – Sample Reference Table for East Load and Wind Regulating Component Reserves

Bin	Up Reserve (MW)	Load Forecast (MW)	Down Reserve (MW)	Up Reserve (MW)	Wind Forecast (MW)	Down Reserve (MW)
	177	10000	261	373	10000	173
1	177	7869	261	373	1070	173
2	254	7475	183	459	935	228
3	161	7220	189	297	827	203
4	255	6984	222	277	762	306
5	271	6807	271	393	695	277
6	327	6621	253	233	628	219
7	232	6482	213	305	562	372
8	182	6383	164	279	508	225
9	179	6285	143	177	440	233
10	210	6158	158	172	394	406
11	258	6023	260	131	351	145
12	225	5850	448	134	305	168
13	237	5720	431	144	264	224
14	149	5568	353	112	229	158
15	163	5404	231	85	196	279
16	153	5275	104	74	162	494
17	96	5134	125	76	116	240
18	69	5005	111	44	82	94
19	51	4892	97	38	46	154
20	179	4521	87	21	-7	112
	179	0	87	21	-7	112

Each of the relationships recorded in the table is then applied to hypothetical operational forecasts. Building on the reference tables above, the hypothetical operational forecasts described in the previously sections were used to calculate a reserve requirement for each interval of historical operational data. This is clarified in the example outlined below.

Application to Component Reserves

For each time interval in the Study Term, component forecasts developed from the hypothetical forecasts are used, in conjunction with Table H.8 and Table H.9, to derive a recommended reserve requirement informed by the load and wind generation conditions. This process can be explained with an example using the tables shown above and hypothetical operational forecasts from June 2013 operational data for PACE. Table H.10 illustrates the outcome of the process for the load following and regulating components.

Table H.10 – Load Forecasts and Component Reserve Requirement Data for Hour-ending 11:00 a.m. June 1, 2013 in PACE

East								
Time	Actual Load (10-min Avg) MW	Actual Load (Hourly Avg) MW	Following Forecast Load MW	Load Following Up Reserves Specified by Tolerance Level MW	Load Following Down Reserves Specified by Tolerance Level MW	Regulating Load Forecast MW	Load Regulating Up Reserves Specified by Tolerance Level MW	Load Regulating Down Reserves Specified by Tolerance Level MW
06/01/2013 10:00	5,337	5,395	5,344	144	171	5,319	153	104
06/01/2013 10:10	5,383	5,395	5,344	144	171	5,350	153	104
06/01/2013 10:20	5,386	5,395	5,344	144	171	5,363	153	104
06/01/2013 10:30	5,403	5,395	5,344	144	171	5,375	153	104
06/01/2013 10:40	5,433	5,395	5,344	144	171	5,388	153	104
06/01/2013 10:50	5,428	5,395	5,344	144	171	5,401	153	104

The load following forecast for this particular hour (hour ending 11:00 a.m.) is 5,344 MW, which designates reserve requirements from Bin 16 as depicted (with shading for emphasis) in Table H.8. Because the 5,344 MW load following forecast falls between 5,264 MW and 5,406 MW, the value from the higher bin, 144 MW, as opposed to 87 MW, is assigned for this period. Note the same following forecast is applied to each interval in the hour for the purpose of developing reserve requirements. The first 10 minutes of the hour exhibits a load regulating forecast of 5,319 MW, which designates reserve requirements from Table H.9, Bin 16. Note that the load regulating forecast changes every 10 minutes, and as a result, the load regulating component reserve requirement can change very ten minutes as well-although, this is not observed in the sample data shown above. A similar process is followed for wind reserves using Table H.11.

Table H.11 – Interval Wind Forecasts and Component Reserve Requirement Data for Hour-ending 11 a.m. June 1, 2013 in PACE

East								
Time	Actual Wind (10-min Avg)	Actual Wind (Hourly Avg)	Following Forecast Wind:	Wind Follow Up Reserves Specified by Tolerance Level	Wind Follow Down Reserves Specified by Tolerance Level	East Wind Regulating Forecast:	Wind Regulating Up Reserves Specified by Tolerance Level:	Wind Regulating Down Reserves Specified by Tolerance Level:
06/01/2013 10:00	190	217	207	101	287	219	85	279
06/01/2013 10:10	208	217	207	101	287	193	74	494
06/01/2013 10:20	212	217	207	101	287	195	74	494
06/01/2013 10:30	231	217	207	101	287	198	85	279
06/01/2013 10:40	234	217	207	101	287	200	85	279
06/01/2013 10:50	226	217	207	101	287	203	85	279

The wind following forecast for this particular hour (hour ending 11:00 a.m.) is 207 MW, which designates reserve requirements from Bin 15 under wind forecasts as depicted in Table H.8. Note the following forecast is applied to each interval in the hour for developing reserve requirements. Meanwhile, the regulating forecast changes every 10 minutes. The first 10 minutes of the hour

exhibits a wind regulating forecast of 219 MW, which designates reserve requirements from Bin 15 as depicted in Table H.9. Similar to load, the wind regulating forecast changes every 10 minutes, and as a result, the wind regulating component reserve requirement may do so as well. In this particular case, the second interval's forecast (193 MW) shifts the wind regulating component reserve requirement from Bin 15 into Bin 16, per Table H.9, and the component reserve requirement changes accordingly.

The assignment of component reserves using component hypothetical operational forecasts as described above is replicated for each 10-minute interval for the entire Study Term. The load following reserves, wind following reserves, load regulating reserves, and wind regulating reserves are then combined into following reserves and regulating reserves. Given that the four component reserves are to cover different deviations between actual and forecast values, they are not additive. In addition, as discussed in the Company's 2012 WIS report, the deviations of load and wind are not correlated.³³ Therefore, for each time interval, the wind and load reserve requirements are combined using the root-sum-of-squares (RSS) calculation in each direction (up and down). The combined results are then adjusted as the appropriate system L_{10} is subtracted and the ramp added to obtain the final result:

$$\sqrt{\text{Load Regulating}_i^2 + \text{Wind Regulating}_i^2 + \text{Load Following}_i^2 + \text{Wind Following}_i^2} - L_{10} + \text{Ramp},$$

where i represents a 10-minute time interval. Assuming the ramp reserve for the east at 10:00 a.m. is 50 MW, and drawing from the first 10-minute interval in the example in Table H.10 and Table H.11.

Load Regulating _{i} = 153 MW

Wind Regulating _{i} = 85 MW

Load Following _{i} = 144 MW

Wind Following _{i} = 101 MW

East System L_{10} = 48 MW

East Ramp _{i} = 50 MW,

The regulating margin for 10:00 a.m. is determined as:

$$\sqrt{153^2 + 85^2 + 144^2 + 101^2} - 48 + 50 = 251 \text{ MW}$$

In this manner, the component reserve requirements are used to calculate an overall reserve requirement for each 10-minute interval of the Study Term. A similar calculation is also made for the regulating margin pertaining only to the variability and uncertainty of load, while assuming zero reserves for the wind components. The incremental reserves assigned to wind generation are calculated as the difference between the total regulating margin requirement and the load-only regulating margin requirement.

³³ The discussion starts on page 111 of Appendix H in Volume II of the Company's 2012 IRP report: http://www.pacificorp.com/content/dam/pacificorp/doc/Energy_Sources/Integrated_Resource_Plan/2013IRP/PacificCorp-2013IRP_Vol2-Appendices_4-30-13.pdf

Application of Regulating Margin Reserves in Operations

The methodology for estimating regulating margin requirements described above subsequently informs the projected regulating margin needs in operations. PacifiCorp applies the data from the reserve tables, as depicted in Table H.8 and Table H.9, to derive regulating margin requirements within its energy trading system, which is used to manage PacifiCorp’s electricity and natural gas physical positions. As such, the regulating margin requirements derived as part of this wind integration study are used when PacifiCorp schedules system resources to cost effectively and reliably meet customer loads. In operations, scheduling system resources to meet regulating margin requirements ensures that PacifiCorp can meet the BAAL reliability standard. This standard is tied to real-time system frequency, and as this frequency fluctuates, real-time operators use regulating margin reserves to maintain or correct frequency deviations within the allowable 30-minute period, 100% of the time.

Determination of Wind Integration Costs

Wind integration costs reflect production costs associated with additional reserve requirements to integrate wind in order to maintain reliability of the system, and additional costs incurred with daily system balancing that is influenced by the unpredictable nature of wind generation on a day-ahead basis. To characterize how wind generation affects regulating margin costs and system balancing costs, PacifiCorp utilizes the Planning and Risk (PaR) model and applies the regulating margin requirements calculated by the method detailed in the section above.

The PaR model simulates production costs of a system by committing and dispatching resources to meet system load. For this study, PacifiCorp developed seven different PaR simulations. These simulations isolate wind integration costs associated with regulating margin reserves and system balancing practice. The former reflects wind integration costs that arise from short-term variability (within the hour and hour ahead) in wind generation and the latter reflects integration costs that arise from errors in forecasting wind generation on a day-ahead basis. The seven PaR simulations used in the WIS are summarized in Table H.12.

Table H.12 – Wind Integration Cost Simulations in PaR

PaR Model Simulation	Forward Term	Load	Wind Profile	Incremental Reserve	Day-ahead Forecast Error	Comments
Regulating Margin Reserve Cost Runs						
1	2015	2015 Load Forecast	Expected Profile	Load	None	
2	2015	2015 Load Forecast	Expected Profile	Load and Wind	None	
<i>Regulating Margin Cost = System Cost from PaR Simulation 2 less System Cost from PaR Simulation 1</i>						
System Balancing Cost Runs						
3	2015	2013 Day-ahead Forecast	2013 Day-ahead Forecast	Yes	None	Commit units based on day-ahead load forecast, and day-ahead wind forecast
4	2015	2013 Actual	2013 Actual	Yes	For Load and Wind	Apply commitment from Simulation 3
5	2015	2013 Actual	2013 Day-ahead Forecast	Yes	None	Commit units based on actual Load, and day-ahead wind forecast
6	2015	2013 Actual	2013 Actual	Yes	For Wind	Apply commitment from Simulation 5
7	2015	2013 Actual	2013 Actual	Yes	None	Commit units based on actual Load, and actual wind forecast
Load System Balancing Cost = System Cost from PaR Simulation 4, which uses the unit commitment from Simulation 3 based on day-ahead forecast load (and day-ahead wind) less System Cost from PaR Simulation 6, which uses the unit commitment from Simulation 5 based on actual load (and day-ahead wind)						
Wind System Balancing Cost = System Cost from PaR Simulation 6, which uses the unit commitment from Simulation 5 based on day-ahead wind (and actual load) less System Cost from PaR Simulation 7, which commits units based on actual wind (and actual load)						

The first two simulations are used to determine operating reserve wind integration costs in forward planning timeframes. The approach uses “P50”, or expected, wind generation profiles and forecasted loads that are applicable to 2015.³⁴ Simulation 1 includes only the load regulating margin reserves. Simulation 2 includes regulating margin reserves for both load and wind, while keeping other inputs unchanged. The difference in production costs between the two simulations determines the cost of additional reserves to integrate wind, or the intra-hour wind integration cost. The remaining five simulations support the calculation of system balancing costs related to committing resources based on day-ahead forecasted wind generation and load. These simulations were run assuming operation in the 2015 calendar year, applying 2013 load and wind data. This calculation method combines the benefits of using actual system data with current forward price curves pertinent to calculating the costs for wind integration service on a forward basis, as well as the current resource portfolio.³⁵ PacifiCorp resources used in the simulations are based upon the 2013 IRP Update resource portfolio.³⁶

Determining system balancing costs requires a comparison between production costs with day-ahead information as inputs and production costs with actual information as inputs. 2013 was the most recent year with the availability of these two types of data. Day-ahead wind generation forecasts for all owned and contracted wind resources were collected from the Company’s wind forecast service provider, DNV GL.³⁷ For 2012 and 2013, DNV GL provided data sets for the historical day-ahead wind forecasts. The day-ahead load forecast was provided by the

³⁴ P50 signifies the probability exceedance level for the annual wind production forecast; at P50 generation is expected to exceed the assumed generation levels half the time and to fall below the assumed generation levels half the time.

³⁵ The Study uses the December 31, 2013 official forward price curve (OFPC).

³⁶ The 2013 Integrated Resource Update report, filed with the state utility commissions on March 31, 2014 is available for download from PacifiCorp’s IRP Web page using the following hyperlink:

<http://www.pacificorp.com/es/irp.html>

³⁷ This is the same service provider as used by the Company previously, Garrad Hassan. Garrad Hassan is now part of DNV GL.

Company's load forecasting department. There are five PaR simulations to estimate daily system balancing wind integration costs, labeled as Simulations 3 through 7. In this phase of the analysis, PacifiCorp generation assets were committed consistent with a day-ahead forecast of wind and load, but dispatched against actual wind and load. To simulate this operational behavior, the five additional PaR simulations included the incremental reserves from Simulation 2 and the unit commitment states associated with simulating the portfolio with the day-ahead forecasts.

Load system balancing costs capture the difference between committing resources based on a day-ahead load forecast and committing resources based on actual load, while keeping inputs for wind generation unchanged. Similarly, wind system balancing costs capture the difference between committing resources based on day-ahead wind generation forecasts and committing resources based on actual wind generation, while keeping inputs for load unchanged. Simulation 3 determines the resource commitment for load system balancing and Simulation 5 determines the resource commitment for wind system balancing. The difference in production costs between Simulations 4 and 6 is the load system balancing cost due to committing resources using imperfect foresight on load. The difference in production cost between Simulations 6 and 7 is the wind system balancing cost due to committing resources using imperfect foresight on wind generation.

Table H.12 above is a revision from what was presented in the 2012 WIS. The revision was made to remove the impact of volume changes between day-ahead forecasts and actuals on production costs. Table H.13 lists the simulations performed in the 2012 WIS, which shows that wind system balancing costs were determined based on the change in production costs between Simulation 5 and Simulation 4. The wind system balancing costs are captured by committing resources based on a day-ahead forecast of wind generation, while operating the resources based on actual wind generation. However, between Simulation 4 and Simulation 5, the volume of wind generation is different. As a result, the production cost of Simulation 5 is impacted by changes in wind generation. Using the approach adopted in the 2014 WIS as discussed above isolates system balancing integration costs to changes unit commitment.

Table H.13 – Wind Integration Cost Simulations in PaR, 2012 WIS

PaR Model Simulation	Forward Term	Load	Wind Profile	Incremental Reserve	Day-ahead Forecast Error
Regulating Margin Reserve Cost Runs					
1	2015	2015 Load Forecast	Expected Profile	No	None
2	2015	2015 Load Forecast	Expected Profile	Yes	None
<i>Regulating Margin Cost = System Cost from PaR Simulation 2 less System Cost from PaR Simulation 1</i>					
System Balancing Cost Runs					
3	2015	2013 Day-ahead Forecast	2013 Day-ahead Forecast	Yes	None
4	2015	2013 Actual	2013 Day-ahead Forecast	Yes	For Load
5	2015	2013 Actual	2013 Actual	Yes	For Load and Wind
Load System Balancing Cost = System Cost from PaR simulation 4 (which uses the unit commitment from Simulation 3) less system cost from PaR simulation 3					
Wind System Balancing Cost = System Cost from PaR simulation 5 (which uses the unit commitment from Simulation 4) less system cost from PaR simulation 4					

Also different from the 2012 WIS, the regulating margin reserves are input to the PaR model on an hourly basis, after being reduced for the estimated benefits of participating in the EIM, as discussed in more detail below. Table H.14 shows the intra-hour and inter-hour wind integration costs from the 2014 WIS.

Table H.14 – 2014 Wind Integration Costs, \$/MWh

	2014 WIS (2015\$)
Intra-hour Reserve	\$2.35
Inter-hour/System Balancing	\$0.71
Total Wind Integration	\$3.06

In the 2015 IRP process, the System Optimizer (SO) model uses the 2014 WIS results to develop a cost for wind generation services. Once candidate resource portfolios are developed using the SO model, the PaR model is used to evaluate the risk profiles of the portfolios in meeting load obligations, including incremental operating reserve needs. Therefore, when performing IRP risk analysis using PaR, specific operating reserve requirements consistent with this wind study are used.

Sensitivity Studies

The Company performed several sensitivity scenarios to address recommendations from the TRC in its review of PacifiCorp's 2012 WIS. Each is discussed in turn below.

Modeling Regulating Margin on a Monthly Basis

As shown in Table H.10 and Table H.11, the component reserves and the total reserves are determined on a 10-minute interval basis. In the 2012 WIS, PacifiCorp calculated reserve requirements on a monthly basis by averaging the data for all 10-minute intervals in a month and

applying these monthly reserve requirements in PaR as a constant requirement in all hours during a month. The TRC recommended that the reserve requirements could be modeled on an hourly basis to reflect the timing differences of reserves. In calculating wind integration costs for the 2014 WIS, the PacifiCorp modeled hourly reserve requirements as recommended by the TRC. Table H.15 compares wind integration costs from the 2012 WIS with wind integration costs from the 2014 WIS calculated using both monthly and hourly reserve requirements as inputs to the PaR model.

Table H.15 – Comparison of Wind Integration Costs Calculated Using Monthly and Hourly Reserve Requirements as Inputs to PaR, (\$/MWh)

	2012 WIS Monthly Reserves (2012\$)	2014 WIS Hourly Reserves (2015\$)	2014 WIS Monthly Reserves (2015\$)
Intra-hour Reserve	\$2.19	\$2.35	\$1.66
Inter-hour/System Balancing	\$0.36	\$0.71	\$0.74
Total Wind Integration	\$2.55	\$3.06	\$2.40

Compared to the 2012 WIS intra-hour reserve cost, the 2014 WIS intra-hour reserve cost is lower when reserves are modeled on a monthly basis in PaR. This is primarily due to the addition of the Lake Side 2 combined-cycle plant, which can be used to cost effectively meet regulating margin requirements. Without Lake Side 2, the intra-hour reserve costs for the 2014 WIS Monthly Reserve sensitivity would increase from \$1.66/MWh to \$2.65/MWh. As compared to the 2012 WIS, which reported wind integration costs using monthly reserve data, the increase in cost is primarily due to increases in the market price for electricity and natural gas. Table H.16 compares the natural gas and electricity price assumptions used in the 2012 WIS to those used in the 2014 WIS.

Table H.16 – Average Natural Gas and Electricity Prices Used in the 2012 and 2014 Wind Integration Studies

Study	Palo Verde High Load Hour Power (\$/MWh)	Palo Verde Low Load Hour Power (\$/MWh)	Opal Natural Gas (\$/MMBtu)
2012 WIS	\$37.05	\$25.74	\$3.43
2014 WIS	\$39.13	\$29.31	\$3.88

When modeling reserves on an hourly basis in PaR, the intra-hour reserve cost is higher than when modeling reserves on a monthly basis. This is due to more reserves being shifted from relatively lower-priced hours to relatively higher-priced hours. Figure H.7 shows the average profiles of wind regulating margin reserves from 2013.

Figure H.7 – Average Hourly Wind Reserves for 2013, MW

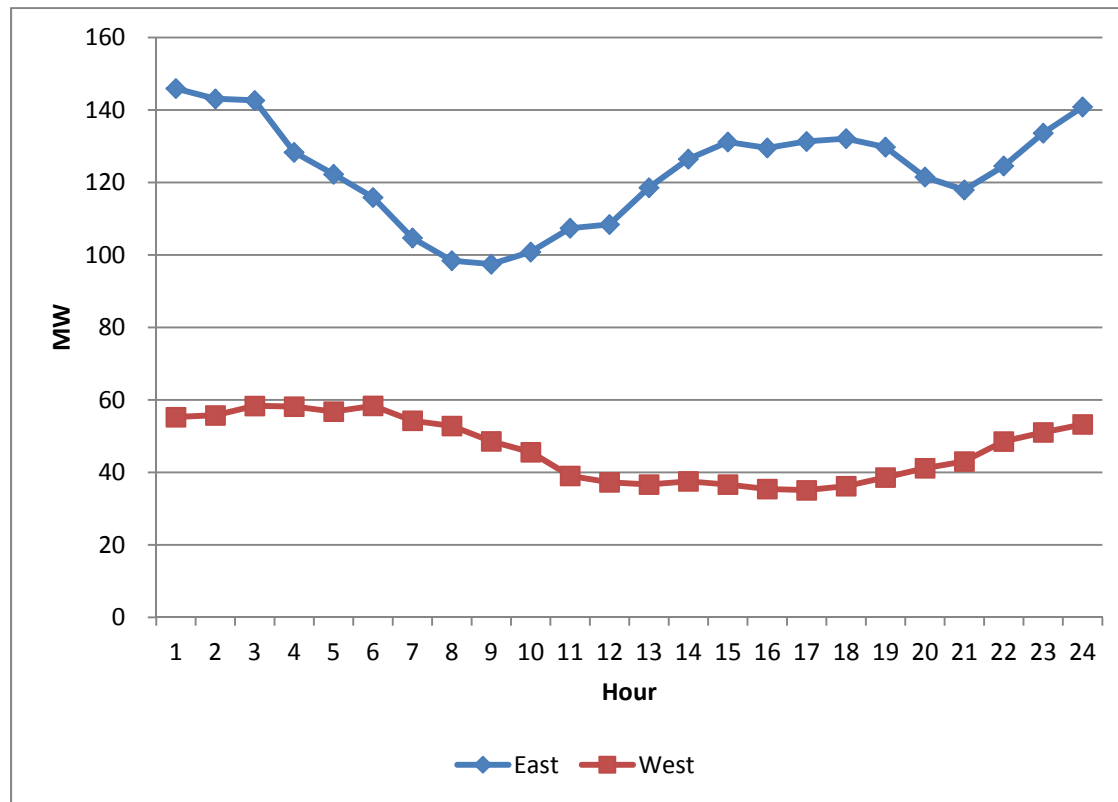

Separating Regulating and Following Reserves

In its review of the 2012 WIS, the TRC recommended treating categories of reserves differently by separating the component reserves of regulating, following and ramping. That is, instead of modeling regulating margin as:

$$\sqrt{Load\ Regulating_i^2 + Wind\ Regulating_i^2 + Load\ Following_i^2 + Wind\ Following_i^2} - L_{10} + Ramp,$$

The TRC recommendation requires calculating regulating reserves and following reserves using two separate calculations:

$$Regulating\ Reserves = \sqrt{Load\ Regulating_i^2 + Wind\ Regulating_i^2} - L_{10},\ and$$

$$Following\ Reserves = \sqrt{Load\ Following_i^2 + Wind\ Following_i^2} + Ramp.$$

Because regulating reserves are more restrictive than following reserves (fewer units can be used to meet regulating reserve requirements), the L₁₀ adjustment is applied to the regulating reserve calculation. Ramp reserves can be met with similar types of resources as following reserves, and therefore, are combined with following reserves.

The impact of separating the component reserves as outlined above is to increase the total reserve requirement required on PacifiCorp’s system. Table H.17 shows the total reserve requirement when the separately calculated regulating and following reserves are summed as compared to the total reserves combined using one RSS equation. The total reserve requirement,

when calculated separately, is over 30% higher than the reserve requirement calculated from a single RSS equation. This is a significant increase in the amount of regulation reserves that is inconsistent with how the Company's resources are operated and dispatched. As a result, PacifiCorp did not evaluate this sensitivity in PaR.

Table H.17 – Total Load and Wind Monthly Reserves, Separating Regulating and Following Reserves (MW)

	Combined		Regulating		Following		Total	
	West	East	West	East	West	East	West	East
Jan	238	400	107	196	211	354	318	550
Feb	212	363	100	182	187	318	287	500
Mar	219	357	97	179	202	313	299	492
Apr	240	422	123	224	208	362	331	586
May	192	400	84	205	180	348	264	553
Jun	183	462	70	240	179	393	249	633
Jul	219	427	88	180	206	391	294	572
Aug	220	428	90	188	206	388	296	576
Sep	210	392	100	171	188	361	287	533
Oct	153	335	75	159	131	301	206	461
Nov	301	438	165	228	249	375	414	603
Dec	274	433	122	216	251	375	373	592

Energy Imbalance Market (EIM)

EIM is an energy balancing market that optimizes generator dispatch between PacifiCorp and the CAISO every five minutes via the existing real-time dispatch market functionality. PacifiCorp and the CAISO began a phased implementation of the EIM on October 1, 2014, when EIM was activated to allow the systems that will operate the market to interact under realistic conditions, allowing PacifiCorp to submit load schedules and bid resources into the EIM and allowing the CAISO to use its automated system to generate dispatch signals for resources on PacifiCorp's control areas. The EIM is expected to be fully operational November 1, 2014.

Once EIM becomes fully operational, PacifiCorp must provide sufficient flexible reserve capacity to ensure it is not leaning on other participating balancing authorities in the EIM for reserves. The intent of the EIM is that each participant in the market has sufficient capacity to meet its needs absent the EIM, net of a CAISO calculated reserves diversity benefit. In this manner, PacifiCorp must hold the same amount of regulating reserve under the EIM as it did prior to the EIM, but for a calculated diversity benefit.³⁸ Figure H.8 illustrates this process.

³⁸ Under the EIM, base schedules are due 75 minutes prior to the hour of delivery. The base schedules can be adjusted at 55 minutes and 40 minutes prior to the delivery hour in response to CAISO sufficiency tests. This is consistent with pre-EIM scheduling practices, in which schedules are set 40 minutes prior to the delivery hour.

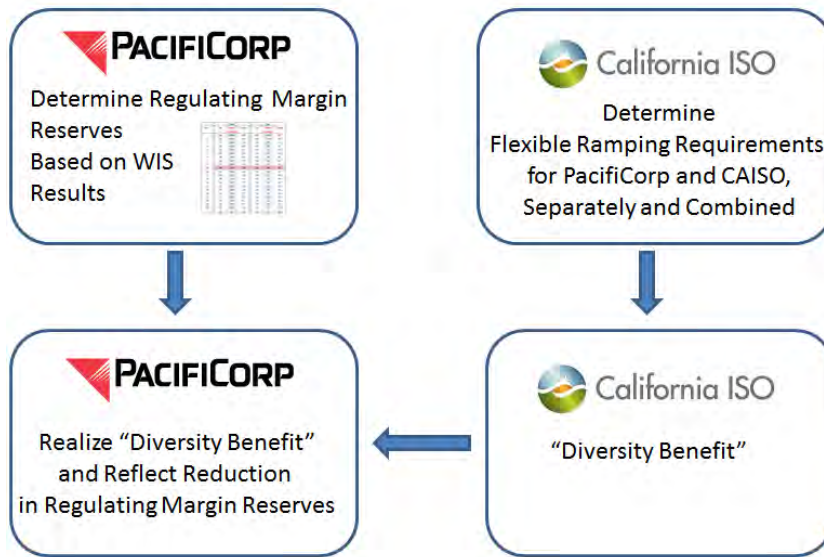
Figure H.8 – Energy Imbalance Market

The CAISO will calculate the diversity benefit by first calculating the reserve requirement for each individual EIM participant and then by comparing the sum of those requirements to the reserve requirement for the entire EIM area. The latter amount is expected to be less than the sum due to the portfolio diversification effect of load and variable energy resource (wind and solar) variations. The CAISO will then allocate the diversity benefit among all the EIM participants. Finally, PacifiCorp will reduce its regulating reserve requirement by its allocation of diversity benefit.

In its 2013 report, Energy and Environmental Economics (E3) estimated the following benefits of the EIM system implementation:³⁹

- PacifiCorp could see a 19 to 103 MW reduction in regulating reserves, depending on the level of bi-directional transmission intertie made available to EIM;
- Interregional dispatch savings: Five-minute dispatch efficiency will reduce “transactional friction” (e.g., transmission charges) and alleviate structural impediments currently preventing trade between the two systems;
- Intraregional dispatch savings: PacifiCorp generators will dispatch more efficiently through the CAISO’s automated system (nodal dispatch software), including benefits from more efficient transmission utilization;
- Reduced flexibility reserves by aggregating the two systems’ load, wind, and solar variability and forecast errors;
- Reduced renewable energy curtailment by allowing BAAs to export or reduce imports of renewable generation when it would otherwise need to be curtailed.

Based on the E3 study, the relationship between the benefit in reducing regulating reserve requirements and the transfer capability of the intertie is shown in Table H.18.

³⁹ <http://www.aiso.com/Documents/PacifiCorp-ISOEnergyImbalanceMarketBenefits.pdf>

Table H.18 – Estimated Reduction in PacifiCorp’s Regulating Margin Due to EIM

Transfer Capability (MW)	Reduction in Flexible Reserves (MW)
100	19
400	78
800	103

Given that the transfer capacity in this WIS is assumed to be approximately 330 MW, through owned and contracted rights, the reduction in regulating reserve is assumed to be approximately 65 MW. This benefit is applied to reduce the regulating margin on PacifiCorp’s west BAA because the current connection between PacifiCorp and CAISO is limited to the west only. Table H.19 summarizes the impact of estimated EIM regulating reserve benefits assuming monthly application of reserves in PaR to be comparable to how the 2012 WIS wind integration costs were calculated. The sensitivity shows that EIM regulating reserve benefits reduce wind integration costs by approximately \$0.21/MWh.

Table H.19 – Wind Integration Cost with and without EIM Benefit, \$/MWh

	2012 WIS (2012\$)	2014 WIS With EIM Benefits (2015\$)	2014 WIS Without EIM Benefits (2015\$)
Intra-hour Reserve Cost	\$2.19	\$1.66	\$1.87
Inter-hour/System Balancing Cost	\$0.36	\$0.74	\$0.74
Total Wind Integration Cost	\$2.55	\$2.40	\$2.61

Summary

The 2014 WIS determines the additional reserve requirement, which is incremental to the mandated contingency reserve requirement, needed to maintain moment-to-moment system balancing between load and generation while integrating wind resources into PacifiCorp’s system. The 2014 WIS also estimates the cost of holding these incremental reserves on its system.

PacifiCorp implemented the same methodology developed in the 2012 WIS for calculating regulating reserves for its 2014 WIS, and implemented recommendations from the TRC to implement hourly reserve inputs when determining wind integration costs using PaR. Also consistent with TRC recommendations, PacifiCorp further incorporated regulation reserve benefits associated with EIM in its wind integration costs. Table H.20 compares the results of the 2014 WIS total reserves to those calculated in the 2012 WIS.

Table H.20 – Regulating Margin Requirements Calculated for PacifiCorp’s System (MW)

Year	Reserve Component	West BAA	East BAA	Ramp	Combined
2011 (2012 WIS)	Load-Only Regulating Reserves	99	176	119	394
	Incremental Wind Reserves	50	126	9	185
	Total Reserves	149	302	128	579
2012	Load-Only Regulating Reserves	95	186	119	400
	Incremental Wind Reserves	71	123	11	206
	Total Reserves	166	309	130	606
2013 (2013 WIS)	Load-Only Regulating Reserves	119	203	119	441
	Incremental Wind Reserves	51	123	12	186
	Total Reserves	169	326	131	626

The anticipated implementation of EIM with the CAISO is expected to reduce PacifiCorp’s reserve requirements due to the diversification of resource portfolios between the two entities. PacifiCorp estimated the benefit of EIM regulating reserve benefits based on a study from E3. The assumed benefits reduce regulating reserves in PacifiCorp’s west BAA by approximately 65 MW from the regulating reserves shown in the table above, which lowers wind integration costs by approximately \$0.21/MWh.

Two categories of wind integration costs are estimated using the Planning and Risk (PaR) model: one for meeting intra-hour reserve requirements, and one for inter-hour system balancing. Table H.21 compares 2014 wind integration costs, inclusive of estimated EIM benefits, to those published in the 2012 WIS.

Table H.21 – 2014 WIS Wind Integration Costs as Compared to 2012 WIS, \$/MWh

	2012 WIS (2012\$)	2014 WIS (2015\$)
Intra-hour Reserve	\$2.19	\$2.35
Inter-hour/System Balancing	\$0.36	\$0.71
Total Wind Integration	\$2.55	\$3.06

The 2014 WIS results are applied to the 2015 IRP portfolio development process as a cost for wind generation resources. Once candidate resource portfolios are developed using the SO model, the PaR model is used to evaluate portfolio risks. After resource portfolios are developed using the SO model, the PaR model is used to evaluate the risk profiles of the portfolios in meeting load obligations, including incremental operating reserve needs. Therefore, when performing IRP risk analysis using PaR, specific operating reserve requirements consistent with the 2014 WIS are used.

Date: December 22, 2014
To: PacifiCorp
From: 2014 Wind Integration Study Technical Review Committee (TRC)
Subject: PacifiCorp 2014 Wind Integration Study Technical Memo

Background

The purpose of the PacifiCorp 2012 wind integration study as identified by PacifiCorp in the Introduction to the 2015 IRP, Appendix H – Draft Wind Integration Study, is to estimate the operating reserves required to both maintain PacifiCorp’s system reliability and comply with North American Electric Reliability Corporation (NERC) reliability standards. PacifiCorp must provide sufficient operating reserves to meet NERC’s balancing authority area control error limit (BAL-001-2) at all times, incremental to contingency reserves, which PacifiCorp maintains to comply with NERC standard BAL-002-WECC-2.^{1,2} Apart from disturbance events that are addressed through contingency reserves, these incremental operating reserves are necessary to maintain area control error³ (ACE), due to sources outside direct operator control including intra-hour changes in load demand and wind generation, within required parameters. The wind integration study estimates the operating reserve volume required to manage load and wind generation variation in PacifiCorp’s Balancing Authority Areas (BAAs) and estimates the incremental cost of these operating reserves.

PacifiCorp currently serves 1.8 million customers across 136,000 square miles in six western states.

According to a company fact sheet available at

http://www.pacificorp.com/content/dam/pacificorp/doc/About_Us/Company_Overview/PC-FactSheet-Final_Web.pdf, PacifiCorp’s generating plants have a net capacity of 10,595 MW, including about 1,900

¹ NERC Standard BAL-001-2: <http://www.nerc.com/files/BAL-001-2.pdf>

² NERC Standard BAL-002-WECC-2 (<http://www.nerc.com/files/BAL-002-WECC-2.pdf>), which became effective October 1, 2014, replaced NERC Standard BAL-STD-002, [which was](#) in effect at the time of this study.

³ “Area Control Error” is defined in the NERC glossary here: http://www.nerc.com/pa/stand/glossary_of_terms/glossary_of_terms.pdf

MW of owned and contracted wind capacity, which provides approximately 8% of PacifiCorp's annual energy. PacifiCorp operates two BAAs in WECC, referenced as PACE (PacifiCorp East) and PACW (PacifiCorp West). The BAAs are interconnected by a limited amount of transmission, and the two BAAs are operated independently at the present time, so wind generation in each BAA is balanced independently.⁴ PacifiCorp has experienced continued wind growth in each BAA, and has been requested to update its wind integration study as part of its IRP. The total amount of wind capacity in PacifiCorp's BAAs, which was included in the 2014 wind integration study, was 2,544 MW.

TRC Process

The Utility Variable-Generation Integration Group (UVIG) has encouraged the formation of a Technical Review Committee (TRC) to offer constructive input and feedback on wind integration studies conducted by industry partners for over 10 years. The TRC is generally formed from a group of people who have some knowledge and expertise in these types of studies, can bring insights gained in previous work, have an interest in seeing the studies conducted using the best available data and methods, and who will stay actively engaged throughout the process. Over time, the UVIG has developed a set of principles which is used to guide the work of the TRC. A modified version of these principles was used in the conduct of this study, and the same version was used for the conduct of the TRC process for the 2012 wind integration study. A copy is included as an attachment to this memo. The composition of the TRC for the 2014 PacifiCorp study was as follows:

- Andrea Coon - Director, Western Renewable Energy Generation Information System (WREGIS) for the Western Electricity Coordinating Council (WECC)
- Matt Hunsaker - Manager, Operations for the Western Electricity Coordinating Council (WECC)
- Michael Milligan – Principal Researcher for the Transmission and Grid Integration Team at the National Renewable Energy Laboratory (NREL)
- J. Charles Smith - Executive Director, Utility Variable-Generation Integration Group (UVIG)
- Robert Zavadil - Executive Vice President of Power Systems Consulting, EnerNex

The TRC was provided with a study presentation in July of 2014, and met by teleconference on 2 occasions during the course of the study, which was completed in November 2014. PacifiCorp provided presentations on the status and results of the work on the teleconferences, with periodic updates

⁴ PacifiCorp and the CAISO began operating an energy imbalance market (EIM) on Oct. 1, 2014, which will likely make wind integration somewhat easier. With the EIM, there would seem to be more impetus for this policy to be reviewed and potentially revised going forward. The TRC recommends that this topic be explored in future work.

during the course of the study, and engaged with the TRC in a robust discussion throughout the work. The teleconferences were followed up with further clarifications and responses to requests for additional information. While the conclusions appear justified by the results of the study, the TRC review should not be interpreted as a substitute for the usual PUC review process.

Introduction

The Company should be acknowledged for the diligent efforts it made in implementing the recommendations by the TRC from the 2012 wind integration study in the 2014 study, as summarized in Table H.1. For example, the company modeled the reserve requirements on an hourly basis in the production cost model, rather than on a monthly average basis; the regulating margin reserve volumes accounted for estimated benefits from PacifiCorp's participation in the energy imbalance market (EIM) with the California Independent System Operator (CAISO); and a discussion on the selection of a 99.7% exceedance level when calculating regulation reserve needs was provided, including a description of how the WIS results inform the amount of regulation reserves planned for operations. Sensitivity studies were performed, including the modeling of the regulating reserves on a monthly basis, and demonstrating the impact of separating the reserves into different categories. The 2014 wind integration study report thoroughly documents the company's analysis.

As pointed out in the report, there is a small but meaningful difference in the integration costs between the 2012 study and the 2014 study. The 2012 value of \$2.55/MWh of wind generation, using monthly reserves in PaR, is slightly less than the 2014 value of \$3.06/MWh, using hourly reserves in the Planning and Risk (PaR) production cost model, with the major difference attributed to the modest increase in the cost of electricity and natural gas. When modeling reserves on an hourly basis in PaR, the intra-hour reserve cost is higher than when modeling reserves on a monthly basis. This is due to more reserves being shifted from relatively lower-priced hours to relatively higher-priced hours.

Analytical Methodology

- The first paragraph on p. 24 of the revised Appendix H, entitled "Application of Regulating Margin Reserves in Operations" is a critical aspect of this study, albeit a little late to the interactions between Pacificorp and the TRC. In effect, it means that the results of this study are and have been applied in operations, which is very unique in the universe of wind integration analysis since nearly all other studies are forward looking and utilize synthesized data and other assumptions. While this paragraph sufficiently addresses the points raised by the TRC in the late summer of 2014, it should receive more prominence in the report. A comparison of the interaction between the 2012 study methodology and PacifiCorp operations with the 2014 study methodology and Pacificorp operations should be included at the front of the document.

Assumptions

- The assumptions generally seem reasonable. PAC does a good job of laying out the process they use for the modeling and analysis. They have also provided discussion of the previous suggestions (from the 2012) study made by the TRC.
- The report addresses the issue of the 99.7% coverage of variability, and says that the operators are expected to have sufficient reserves to cover all variability all of the time. It would be interesting to contrast the company's policy of ensuring 100% reserve compliance with actual system performance. In the November TRC call there was some helpful discussion on this issue. One item discussed was that using 99.7% provides some margin of error in case a lower value, such as 95%, is used in the study but insufficient if the actual variability of wind/load were to increase. It would be nice to see this discussion reflected in the report, which would provide some additional justification for the 99.7 percentile. The reason this point is raised is to magnify the point that PAC makes in the report; that there is a tradeoff between economics and reliability. Holding the system to an extremely high effective CPS performance will be somewhat costly, and it is not clear what impact this is having on wind integration costs.
- The use of actual historical wind production data is excellent, and something that many studies are unable to do. This means that the PAC study is somewhat unique and PAC is to be commended for doing this work. At the same time, the report provides some illumination on the difficulties in using actual data, because data recovery rates can compromise the time series. PAC has done a good job in analyzing and correcting these inevitable data gaps, and this should not have a significant impact on the study results.

Results

- Table H.15 documents a comparison of the monthly versus hourly reserve modeling, and shows that a constant monthly reserve is less costly than reserves modeled on an hourly basis. The explanation provided is useful, but may leave out some factors such as non-linearity in reserve supply curve. In addition, the shifting of reserves from lower price hours to higher price hours only seems to apply to the East area, as the West area exhibits the opposite characteristic.

Discussion and Conclusions

- Table H.17 shows that the total reserves increase with consideration of regulation and following separately. It should be noted that while the arithmetic sum of the reserves does increase, it would not necessarily lead to higher costs as some of the following reserve could be obtained from non-spinning and quick-start resources which cost little to have on standby for such purpose.
- Based on the information provided by PacifiCorp, the methodology used in the wind integration study appears to be reasonable. Based on the draft study report, the findings and conclusions

appear sound. The findings appear to be useful to inform the Integrated Resource Planning process.

Recommendations for Future Work

Wind Integration modeling presented is unique in how it is integrated with the operating process at PacifiCorp. There are some sensitivity studies which could be done to shed additional light on the results and provide some useful insights:

- Future work should explore balancing area cooperation between PACE and PACW under the EIM framework.
- Regulating margin implies reserve capacity available on very short notice (ten minute or less). The ramping and following reserve categories do not all require fast response. Future sensitivity studies could be done to compare the results from PaR to use of the RSS formula.
- It might be useful to perform some additional sensitivities on natural gas price. For example, integration costs would be expected to increase with gas prices, yet at higher gas prices PAC would be getting a larger benefit from wind energy.
- A sensitivity analysis with carbon tax assumptions could also provide some useful insight and results.

Concurrence provided by:

Andrea Coon – Director of WREGIS, WECC

Matt Hunsaker - Manager, Operations, WECC

Michael Milligan - Principal Researcher, Transmission and Grid Integration Team, NREL

J. Charles Smith - Executive Director, UVIG

Robert Zavadil - Executive Vice President, EnerNex

APPENDIX I – PLANNING RESERVE MARGIN STUDY

Introduction

The planning reserve margin (PRM), measured as a percentage of coincident system peak load, is a parameter used in resource planning to ensure there are adequate resources to meet forecasted load over time. PacifiCorp selects a PRM for use in its resource planning by studying the relationship between cost and reliability among ten different PRM levels, accounting for variability and uncertainty in load and generation resources.⁴⁰ Costs include capital and run-rate fixed costs for new resources required to achieve ten different PRM levels, ranging from 11 percent to 20 percent, along with system production costs (fuel and non-fuel variable operating costs, contract costs, and market purchases). In analyzing reliability, PacifiCorp performed a stochastic loss of load study using the Planning and Risk (PaR) production cost simulation model to calculate the following reliability metrics for each PRM level:

- Expected Unserved Energy (EUE): Measured in gigawatt-hours (GWh), EUE reports the expected (mean) amount of load that exceeds available resources over the course of a given year. EUE measures the magnitude of reliability events, but does not measure frequency or duration.
- Loss of Load Hours (LOLH): LOLH is a count of the expected (mean) number of hours in which load exceeds available resources over the course of a given year. A LOLH of 2.4 hours per year equates to one day in 10 years, a common reliability target in the industry. LOLH measures the duration of reliability events, but does not measure frequency or magnitude.
- Loss of Load Events (LOLE): LOLE is a count of the expected (mean) number of reliability events over the course of a given year. A LOLE of 0.1 events per year equates to one event in 10 years, a common reliability target in the industry. LOLE measures the frequency of reliability events, but does not measure magnitude or duration.

PacifiCorp's loss of load study results reflect its participation in the Northwest Power Pool (NWPP) reserve sharing agreement. This agreement allows a participant to receive energy from other participants within the first hour of a contingency event, defined as an event when there is an unexpected failure or outage of a system component, such as a generator, transmission line, circuit breaker, switch, or other electrical element. PacifiCorp's participation in the NWPP reserve sharing agreement improves reliability at a given PRM level. Upon evaluating the relationship between cost and reliability in its PRM study, PacifiCorp will continue to use a 13 percent target PRM in its resource planning.

Methodology

Figure I.1 shows the workflow used in PacifiCorp's PRM study. The four basic modeling steps in the workflow include: (1) using the System Optimizer (SO) model, produce resource portfolios among eleven different PRM levels ranging between 10 percent and 20 percent; (2) using the Planning and Risk model (PaR), produce reliability metrics for each resource portfolio;

⁴⁰ Costs and reliability metrics are calculated for eleven different PRM levels, ranging from 10 percent to 20 percent. Comparative analysis among each PRM is performed for 10 different PRM levels by comparing the cost and reliability results from PRM levels ranging between 11 percent and 20 percent to those from the 10 percent PRM.

(3) using PaR, produce system variable costs for each resource portfolio; (4) calculate the incremental cost of reliability among PRM levels analyzed.

Figure I.1 – Workflow for Planning Reserve Margin Study

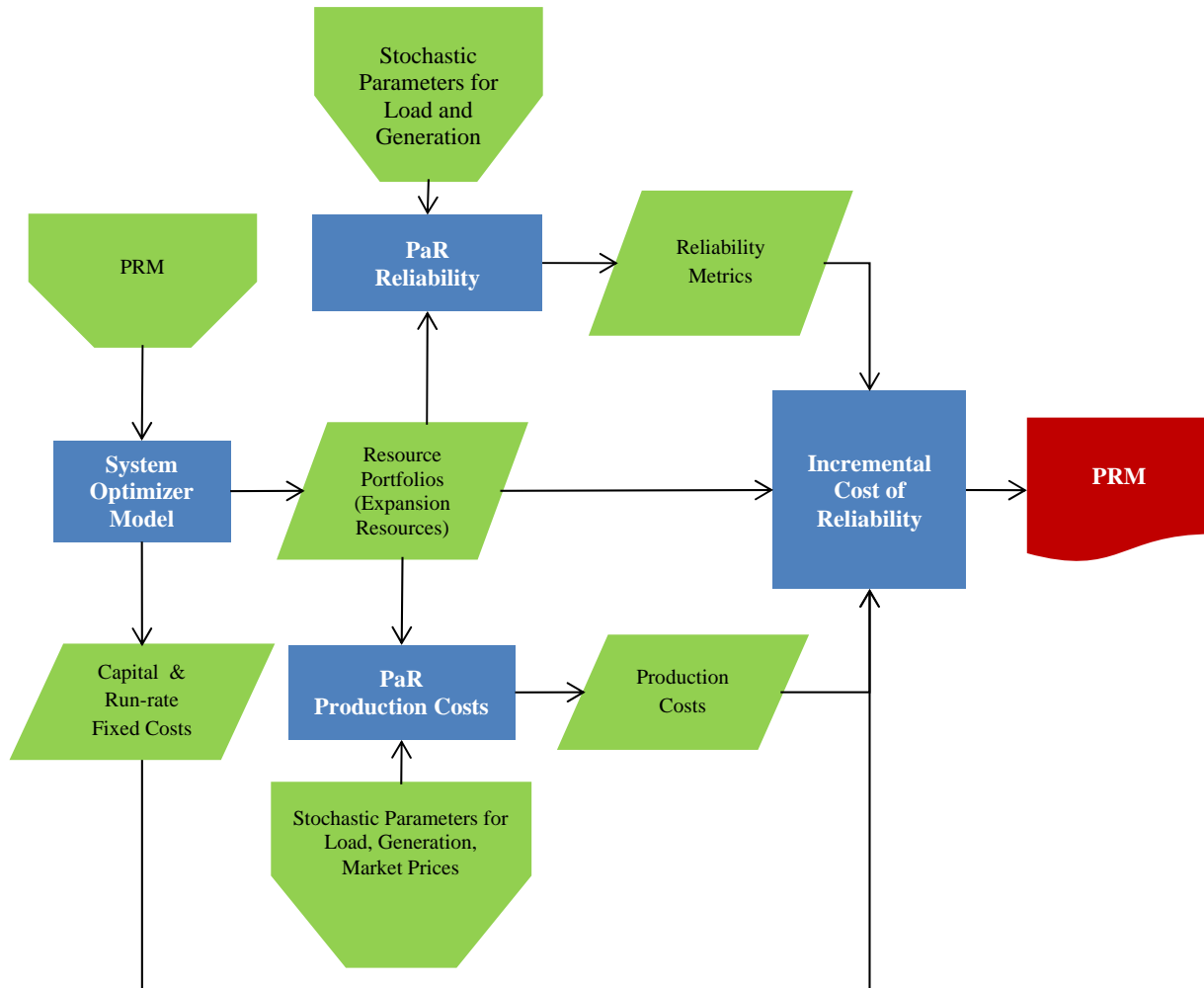

Development of Resource Portfolios

The SO model is used to produce resource portfolios assuming PRM levels ranging between 10 percent and 20 percent. The SO model optimizes expansion resources over a 20-year planning horizon to meet peak load inclusive of the PRM applicable to each case. As the PRM level is increased from 10 percent to 20 percent, additional resources are added to the portfolio. Resource options used in this step of the workflow include demand side management (DSM), gas-fired combined cycle combustion turbines (CCCT), and gas-fired simple cycle combustion turbines (SCCT).

Front office transactions (FOTs) are not considered as a resource expansion option in this phase of the workflow. FOTs are proxy resources used in the IRP portfolio development process that represent firm forward short-term market purchases for summer on-peak delivery, which coincides with the time of year and time of day in which PacifiCorp observes its coincident system peak load. These proxy resources are a reasonable representation of firm market purchases when performing comparative analysis of different resource portfolios to arrive at a

preferred portfolio in the IRP. However, given the seasonal and intra-day pattern of these proxy resource options, they are not as well suited for a loss of load study that evaluates reliability metrics across all hours in a given year. The contribution of firm market purchases to reliability, up to transmission and market depth limits that are identical for all scenarios, are accounted for in the loss of load study by allowing system balancing hourly purchases in the subsequent workflow step where reliability metrics are produced using PaR.

Upfront capital and run-rate fixed costs from each portfolio are recorded and used later in the workflow where the relationship between cost and reliability is analyzed. Resources from each portfolio are used in the subsequent workflow steps where reliability metrics and production costs are produced in PaR.

Development of Reliability Metrics

PaR is used to produce reliability metrics for each of the resource portfolios developed assuming PRM levels ranging between 10 percent and 20 percent. PaR is a production cost simulation model, configured to represent PacifiCorp's integrated system, that uses Monte Carlo random sampling of stochastic variables to produce a distribution of system operation. For this step in the workflow, reliability metrics are produced from a 500-iteration PaR simulation with Monte Carlo draws of stochastic variables that affect system reliability—load, hydro generation, and thermal unit outages. As discussed above, system balancing hourly purchases are enabled to capture the contribution of firm market purchases to system reliability. The PaR reliability studies are used to report instances where load exceeds available resources, including system balancing hourly purchases. Reported EUE measures the stochastic mean volume of instances where load exceeds available resources, and is measured in GWh. EUE measures the magnitude of reliability events. Reported LOLH is a count of the stochastic mean hours in which load exceeds available resources. LOLH measures the duration of reliability events. Reported LOLE is a count of the stochastic mean events in which load exceeds available resources. LOLE is a measure of the frequency of reliability events.

Each of the reliability metrics described above is adjusted to account for PacifiCorp's participation in the NWPP reserve sharing agreement, which allows a participant to receive energy from other participants within the first hour of a contingency event. The NWPP adjustments are made to EUE by reducing the stochastic mean volume of instances where load exceeds available resources for the first hour of a reliability event. For example, if the stochastic mean volume of EUE for a reliability event is 120 MWh, equal to 40 MWh in three consecutive hours, then the adjusted EUE is 80 MWh after removing the first hour of the event. Using this same example, LOLH would be adjusted from three to two hours, and LOLE would not be adjusted. The LOLE is only adjusted inasmuch as a given reliability event has a one hour duration.

Development of System Variable Costs

In addition to completing PaR runs to develop reliability metrics, PaR is also used to produce system variable operating costs for each of the resource portfolios developed assuming PRM levels ranging between 10 percent and 20 percent. For the system variable cost PaR runs, Monte Carlo random sampling of stochastic variables is expanded to include natural gas and wholesale market prices in addition to the stochastic variables for load, hydro generation, and thermal unit outages. Including market prices as a stochastic variable is important for this step of the

workflow because of their influence the economic dispatch of system resources, the cost of system balancing purchases, and revenues from system balancing sales. The stochastic mean of system variable costs is added to the upfront capital and run-rate fixed costs from each portfolio so that total portfolio costs are captured for each PRM level.

Calculating the Incremental Cost of Reliability

Using 2017 as the reference year, the cost of reliability is calculated as the difference in fixed and variable system costs at each PRM level relative to total costs at a 10 percent PRM. The incremental cost of reliability is calculated by dividing the cost of reliability by the difference in EUE at each PRM level relative to EUE at 10 percent PRM. This calculation yields an incremental cost per megawatt-hour (MWh) of EUE at PRM levels ranging between 11 percent and 20 percent.

Results

Resource Portfolios

Table I.1 shows new resources added to the portfolio at PRM levels ranging between 10 percent and 20 percent. Each portfolio includes a 420 megawatt (MW) CCCT. New SCCT resource capacity totals 976 MW at the 10 percent PRM, rising to 1,996 MW at a 20 percent PRM. DSM resource additions range between 1,010 MW and 1,107 MW (between 358 MW and 424 MW during system peak hours). As the PRM is increased, system capacity is largely met with additional SCCT resources. Because new SCCT resources are added in blocks indicative of a typical plant size (i.e. the model cannot add a 2 MW SCCT plant), the addition of new DSM resources does not always increase with each sequential increase in the PRM.

Table I.1 – Expansion Resources Additions by PRM

PRM (%)	DSM		SCCT (MW)	CCCT (MW)	Total at System Peak (MW)
	Maximum (MW)	Capacity at System Peak (MW)			
10	1,029	372	976	420	1,768
11	1,017	363	1,157	420	1,940
12	1,020	365	1,259	420	2,045
13	1,032	375	1,259	420	2,055
14	1,017	363	1,440	420	2,224
15	1,043	384	1,440	420	2,244
16	1,010	358	1,602	420	2,380
17	1,065	397	1,612	420	2,428
18	1,017	363	1,793	420	2,576
19	1,107	424	1,793	420	2,637
20	1,096	416	1,996	420	2,832

Reliability Metrics

Table I.2 shows EUE, LOLH, and LOLE reliability results before and after adjusting these reliability metrics for PacifiCorp's participation in the NWPP reserve sharing agreement. Each of the reliability metrics generally improve as the PRM increases and after accounting for benefits associated with PacifiCorp's participation in the NWPP reserve sharing agreement. After

accounting for its participation in the NWPP reserve sharing agreement, all PRM levels meet a one day in ten year planning criteria (LOLH at or above 2.4), and PRM levels of between 15 and 16 percent meet a one event in ten year planning criteria (LOLE at or above 0.1).

Table I.2 – Expected Reliability Metrics by PRM

PRM (%)	Before NWPP Adjustment			After NWPP Adjustment		
	EUE (GWh/yr)	LOLH (Hours/yr)	LOLE (Events/yr)	EUE (GWh/yr)	LOLH (Hours/yr)	LOLE (Events/yr)
10	301	2.60	0.87	200	1.73	0.48
11	183	2.03	0.74	116	1.29	0.41
12	197	1.78	0.50	141	1.27	0.29
13	122	1.51	0.43	87	1.08	0.29
14	84	1.24	0.35	60	0.89	0.25
15	98	1.19	0.30	73	0.89	0.22
16	32	0.34	0.20	13	0.13	0.04
17	68	0.46	0.18	41	0.28	0.07
18	17	0.30	0.12	10	0.18	0.05
19	17	0.40	0.18	9	0.22	0.08
20	13	0.27	0.12	7	0.15	0.04

The reliability metrics do not monotonically improve with each incremental increase in the PRM. This is influenced by the physical location of new resources within PacifiCorp’s system at varying PRM levels and the ability of these resources to serve load in all load pockets when Monte Carlo sampling is applied to load, hydro generation, and thermal unit outages. Considering that the reliability metrics are measuring very small magnitudes of change among the different PRM levels, the PaR outputs are fit to a logarithmic function to report the overall trend in reliability improvements as the PRM level increases. Table I.3 shows the fitted EUE, LOLH, and LOLE results. Figure I.2, Figure I.3 and Figure I.4 show a plot of the fitted trend for EUE, LOLH, and LOLE, respectively, after accounting for PacifiCorp’s participation in the NWPP reserve sharing agreement.

Table I.3 – Fitted Reliability Metrics by PRM

PRM (%)	Before NWPP Adjustment			After NWPP Adjustment		
	EUE (GWh/yr)	LOLH (Hours/yr)	LOLE (Events/yr)	EUE (GWh/yr)	LOLH (Hours/yr)	LOLE (Events/yr)
10	294	2.78	0.90	198	1.88	0.52
11	211	2.05	0.66	142	1.38	0.38
12	162	1.62	0.53	109	1.09	0.30
13	127	1.32	0.43	86	0.88	0.24
14	101	1.08	0.36	67	0.72	0.20
15	79	0.89	0.30	53	0.59	0.16
16	60	0.73	0.25	40	0.48	0.13
17	44	0.59	0.20	29	0.38	0.10
18	30	0.46	0.16	20	0.30	0.08
19	18	0.35	0.13	11	0.22	0.06
20	6	0.25	0.10	3	0.15	0.04

Figure I.2 – Expected and Fitted Relationship of EUE to PRM

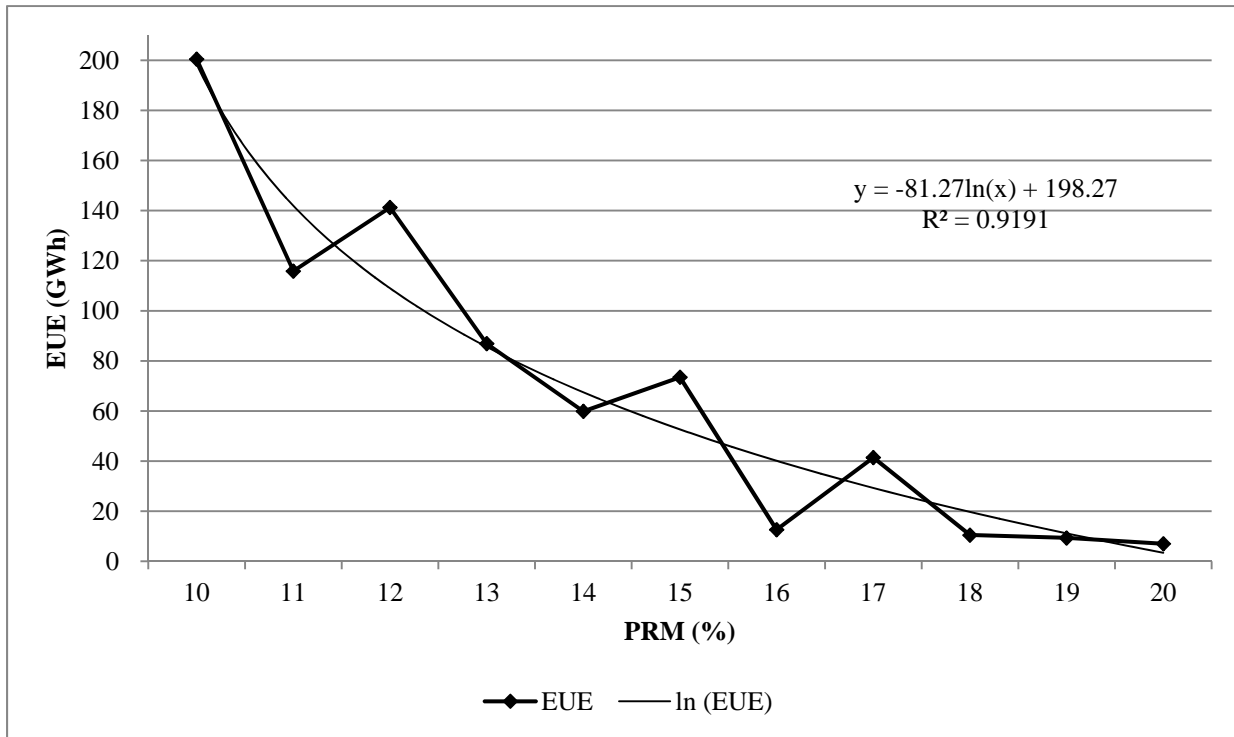

Figure I.3 – Expected and Fitted Relationship of LOLH to PRM

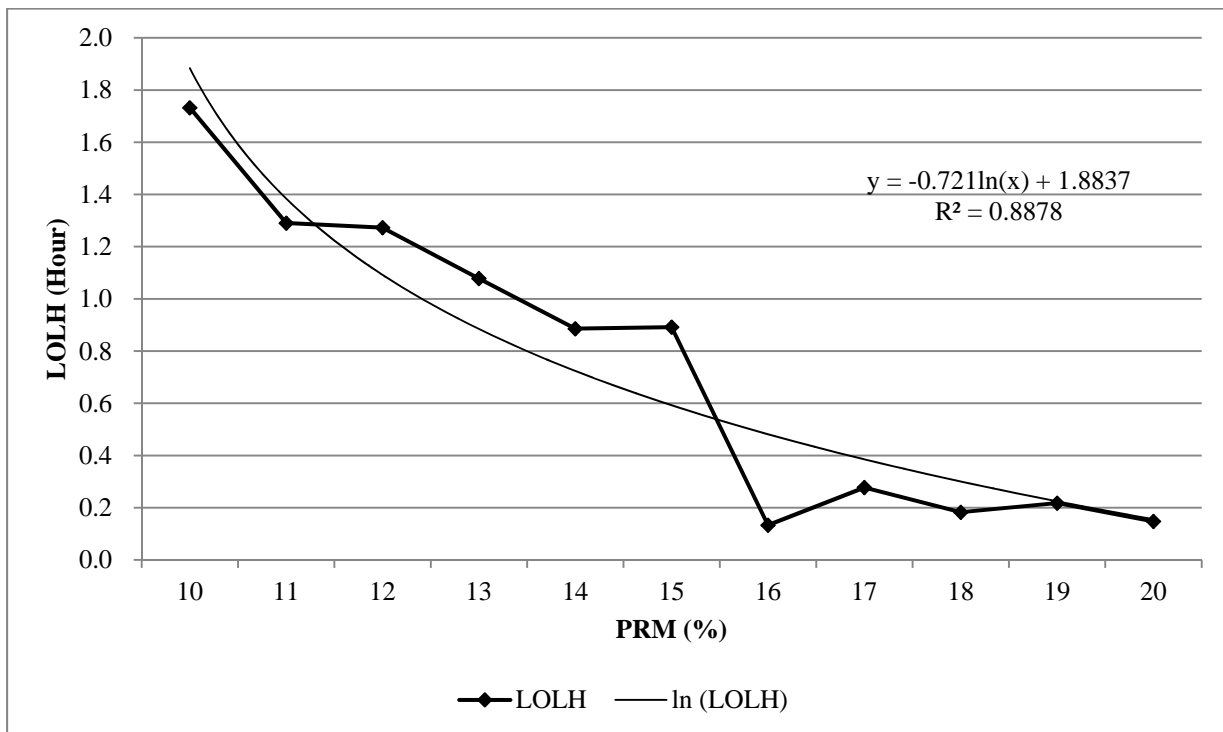
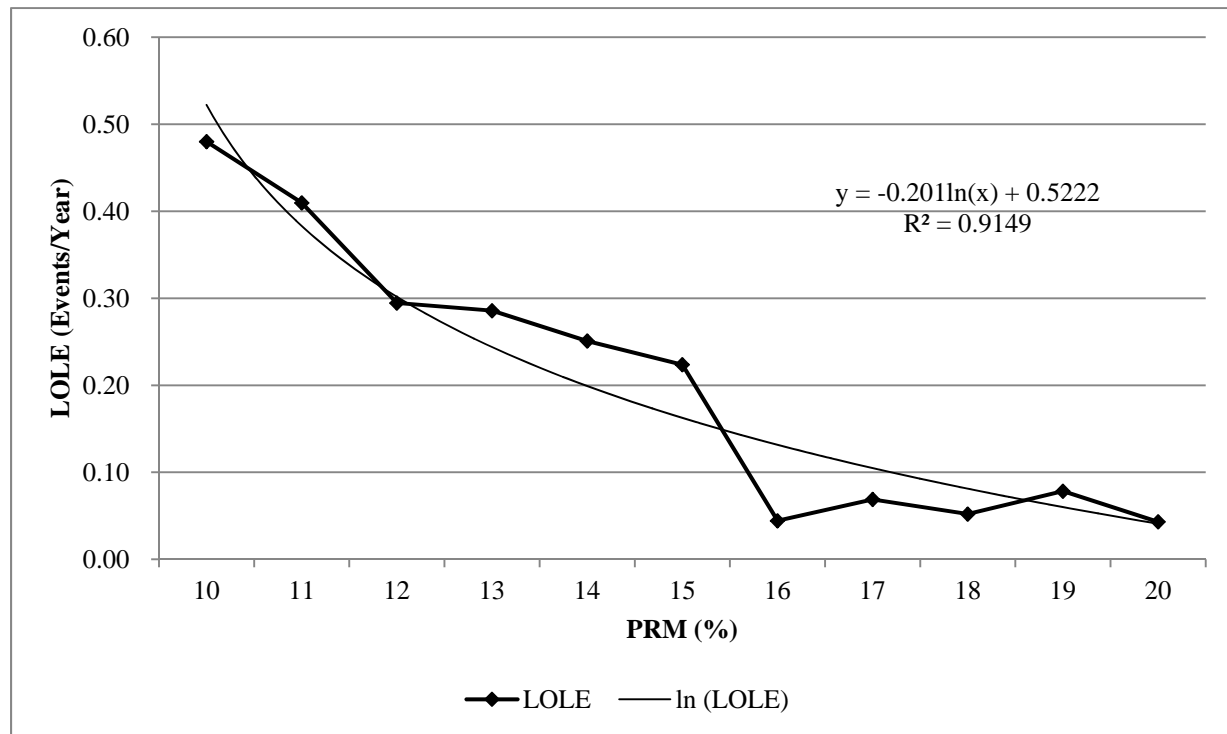

Figure I.4 – Simulated Relationship of Loss of Load Episode to PRM



System Costs

For the 2017 reference year, Table I.4 shows the stochastic mean of system variable costs and the upfront capital and run-rate fixed costs, including the cost of new DSM resources, for each portfolio developed at PRM levels ranging between 10 percent and 20 percent. The fixed costs associated with these new resource additions drive total costs higher as PRM levels increase. DSM run-rate costs increase most substantially once the PRM level exceeds 18 percent, indicating that incremental DSM resource selections for portfolios developed at the 19 percent and 20 percent PRM levels were taken from higher cost resources in the DSM supply curve.

Table I.4 – System Variable, Up-front Capital, and Run-rate Fixed Costs by PRM

PRM (%)	System Variable Costs (\$ thousands)	DSM Run-rate Costs (\$ thousands)	Up-front Capital & Run-rate Fixed Costs (\$ thousands)	Total Cost (\$ thousands)
10	1,292,361	34,498	237,119	\$1,563,978
11	1,292,341	32,177	256,251	\$1,580,769
12	1,288,956	32,838	276,790	\$1,598,584
13	1,287,921	34,919	275,976	\$1,598,816
14	1,289,097	32,181	295,108	\$1,616,386
15	1,287,021	38,644	295,108	\$1,620,773
16	1,289,396	30,544	314,025	\$1,633,965
17	1,284,925	44,903	314,133	\$1,643,961
18	1,289,300	32,177	333,265	\$1,654,742
19	1,284,132	143,492	334,144	\$1,761,768
20	1,283,763	141,192	363,042	\$1,787,997

Incremental Cost of Reliability

Table I.5 shows the incremental cost of reliability at PRM levels ranging between 11 percent and 20 percent. Figure I.5 depicts this same information graphically. These results show the incremental cost of reliability rises as PRM levels increase from 15 percent and 18 percent, and increase dramatically at PRM levels above 18 percent. The incremental cost of reliability does not vary significantly at PRM levels at or below 15 percent.

Table I.5 – Incremental Cost of Reliability by PRM

PRM (%)	Reduction in Fitted EUE from EUE at 10% PRM After NWPP Adjustment (GWh)	Reduction in Total System Cost from Cost at 10% PRM (\$ thousands)	Incremental Cost of EUE Relative to 10% PRM (\$/MWh of EUE)
11	56	\$16,791	\$298
12	89	\$34,606	\$388
13	113	\$34,838	\$309
14	131	\$52,408	\$401
15	146	\$56,795	\$390
16	158	\$69,987	\$443
17	169	\$79,983	\$473
18	179	\$90,764	\$508
19	187	\$197,790	\$1,057
20	195	\$224,019	\$1,150

Figure I.5 – Incremental Cost of Reliability by PRM

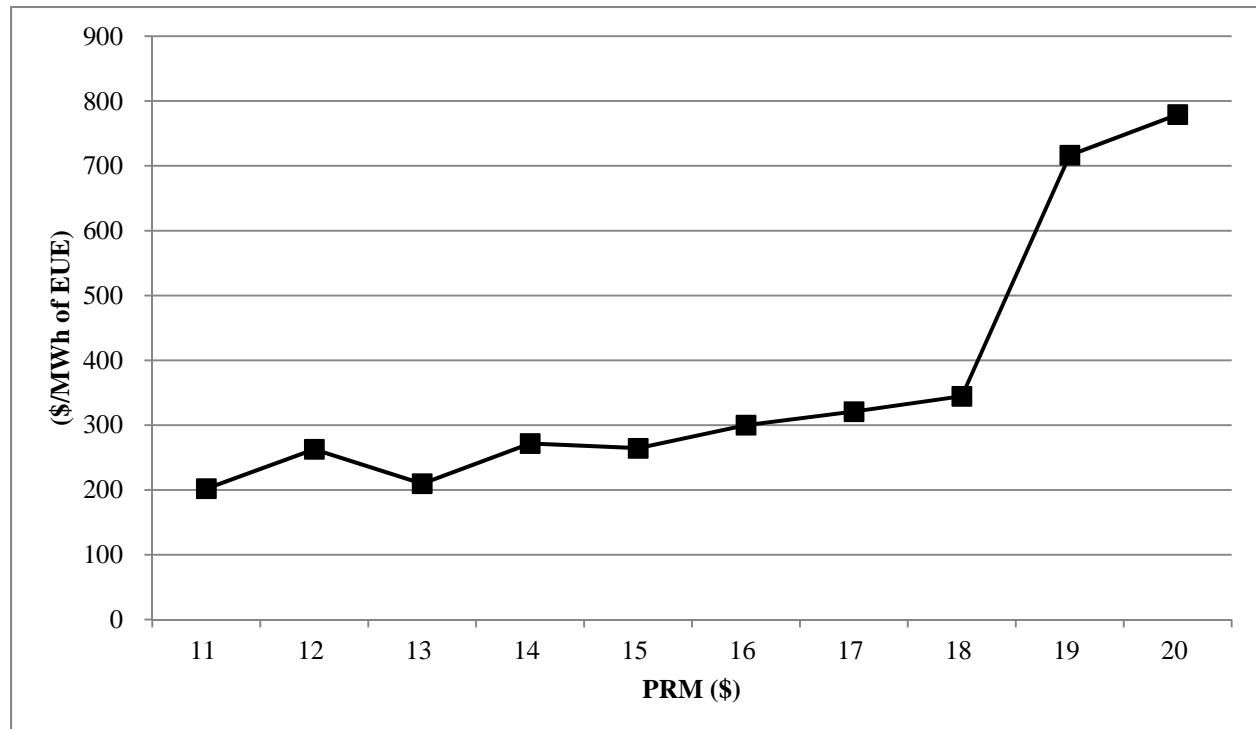

Conclusion

Upon evaluating the relationship between cost and reliability in the PRM study, PacifiCorp will continue to use a 13 percent target PRM in its resource planning. A PRM below 13 percent would not sufficiently cover the need to carry short-term operating reserve needs (contingency and regulating margin) and longer-term uncertainties such as extended outages and changes in customer load.⁴¹ A PRM above 15 percent improves reliability above a one event in ten year planning level, though with a 125 percent to 370 percent increase in the incremental cost per megawatt-hour of reduced EUE when compared to a 13 percent PRM. With these considerations, the selected 13 percent PRM level ensures PacifiCorp can reliably meet customer loads while maintaining operating reserves, with a planning criteria that meets one day in 10 year planning targets, at the lowest reasonable cost.

⁴¹ PacifiCorp must hold approximately 6% of its resources in reserve to meet contingency reserve requirements and an estimated additional 4.5% to 5.5% of its resources in reserve, depending upon system conditions at the time of peak load, as regulating margin. This sums to 10.5% to 11.5% of operating reserves before even considering longer-term uncertainties such as extended outages (transmission or generation) and customer load growth.

APPENDIX J – WESTERN RESOURCE ADEQUACY EVALUATION

Introduction

The Utah Commission, in its 2008 IRP acknowledgment order, directed the Company to conduct two analyses pertaining to the Company’s ability to support reliance on market purchases:

Additionally, we direct the Company to include an analysis of the adequacy of the western power market to support the volumes of purchases on which the Company expects to rely. We concur with the Office [of Consumer Services], the WECC is a reasonable source for this evaluation. We direct the Company to identify whether customers or shareholders will be expected to bear the risks associated with its reliance on the wholesale market. Finally, we direct the Company to discuss methods to augment the Company’s stochastic analysis of this issue in an IRP public input meeting for inclusion in the next IRP or IRP update.⁴²

To fulfill the first requirement, PacifiCorp evaluated the Western Electricity Coordinating Council (WECC) Power Supply Assessment (PSA) reports to glean trends and conclusions from the supporting analysis. This evaluation, along with a discussion on risk allocation associated with reliance on market purchases, is provided below. As part of this evaluation, the Company also reviewed the status of resource adequacy assessments prepared for the Pacific Northwest by the Pacific Northwest Resource Adequacy Forum.

Western Electricity Coordinating Council Resource Adequacy Assessment

The WECC 2014 PSA shows a planning reserve margin (PRM) calculated as a percentage of resources (generation and transfers) and load, and is the percentage of capacity above demand. The PRM indicates that there are sufficient resources when the PRM is equal to or greater than the target planning reserve margin. The 2014 PSA shows WECC not needing additional resources throughout the entire period of their study, which ends in 2024 (see Figure J.1). Prior to the 2014 PSA report, WECC utilized eight sub regions in calculating and reporting reserve margins. For the 2014 PSA report, WECC reduced the sub region count from eight to four, with a substantial change in the balancing authority areas (BAA) that make up each sub region. Prior to 2014, PacifiCorp’s western BAA was in the “Northwest” sub region, while PacifiCorp’s eastern BAA was in the “Basin” sub region. In the 2014 PSA report, both of PacifiCorp’s BAA’s are now in the “Northwest Power Pool” (NWPP) region. As a result, comparison to prior year PSA only available on a WECC basis, as none of the prior eight sub regions are comparable to the current four sub regions.

In WECC PSAs, the region and sub region target reserve margins are calculated using a building block methodology created by WECC. As such, they do not reflect a criteria-based margin determination process and do not reflect any balancing authority or load serving entity level

⁴² Public Service Commission of Utah, PacifiCorp 2008 Integrated Resource Plan, Report and Order, Docket No. 09-2035-01, p. 30.

requirements that may have been established through other processes (e.g., state regulatory authorities). They are not intended to supplant any of those requirements.

The WECC building block methodology is comprised of four elements⁴³:

1. Contingency Reserves – An additional amount of operating reserves sufficient to reduce area control error to zero following loss of generating capacity, which would result from the most severe single contingency.
2. Regulating Reserves – The amount of reserves sufficient to provide normal regulating margin. The regulating component of this guideline was calculated using data provided in WECC’s annual loads and resources data request responses.
3. Additional Forced Outages – Reserves for additional forced outages beyond what might be covered by operating reserves in order to cover second contingencies are calculated using the forced outage data supplied to WECC through the loads and resources data request responses. Ten years of data are averaged to calculate both a summer (July) and winter (December) forced outage rate. The same forced outage rate is used for all balancing authorities in WECC when calculating the building block margin.
4. Temperature Adders – Using historic temperature data for up to 20 years, the annual maximum and minimum temperature for each balancing authority’s area was identified. That data was used to calculate the average maximum (summer) and minimum (winter) temperature and the associated standard deviation.

As seen in Figure J.1, the 2014 PSA shows the WECC as having a positive power supply margin (PSM) in all years. The PSM is a measure of a region’s ability to meet total load requirements, including its target reserve margin. As such, a PSM of zero or more indicates that demand plus the target reserve margin was met.

⁴³ Further details of building block elements can be found on the WECC website at the following location: https://www.wecc.biz/Reliability/2014LAR_MethodsAssumptions.pdf

Figure J.1 – WECC Forecasted Power Supply Margins, 2007 to 2014

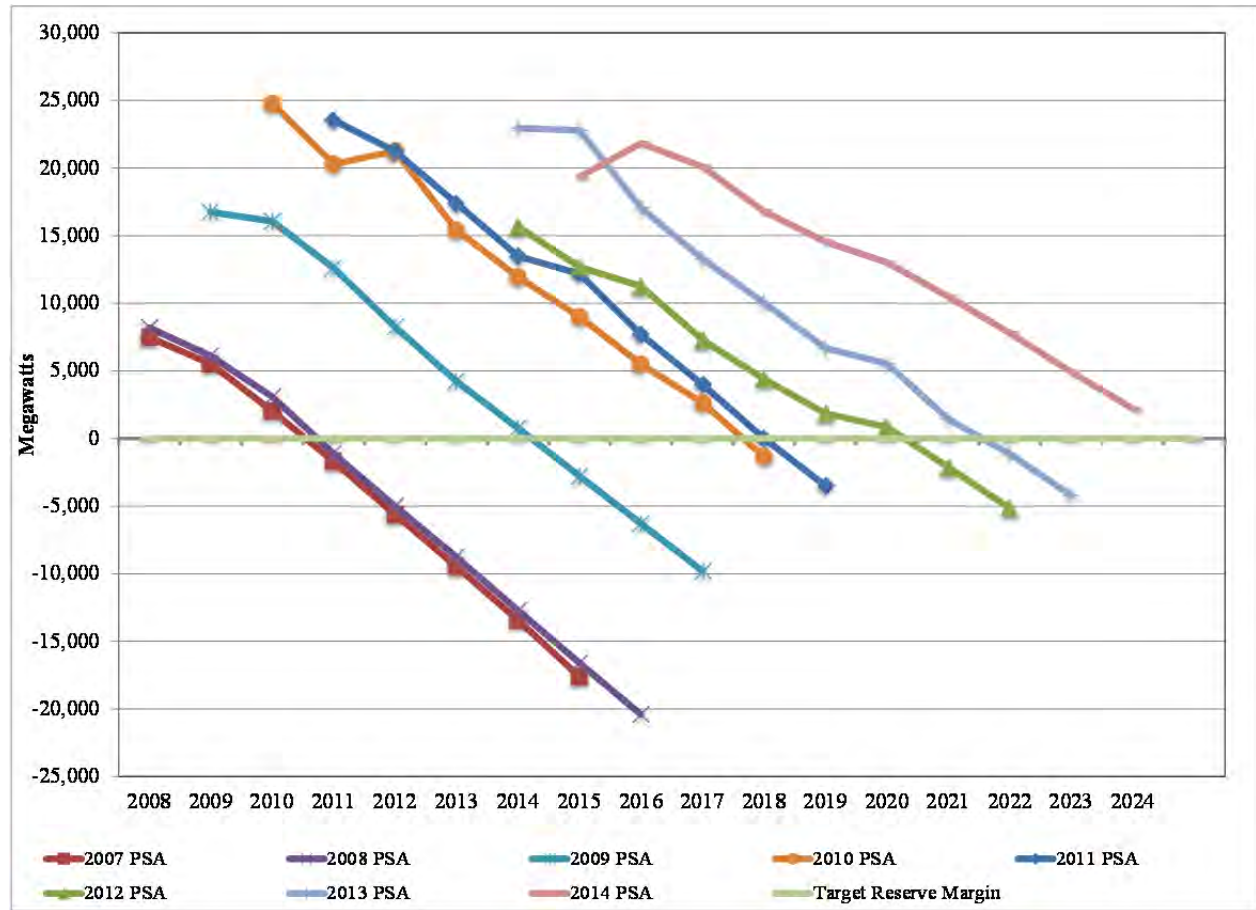

Note: WECC Power Supply Assessments include Class 1 Planned Resources Only

In the 2012 PSA, the WECC study showed a deficit beginning in 2021. For the 2014 PSA there is no deficit period. Figure J.2 shows the difference between the 2014 and 2012 PSA studies. For most years the load forecasts (net internal demand) decreased, while capacity resources increased substantially. The target reserve margins change from year to year, though for the most part are not a major contributor to the year on year PSA deviations.

Figure J.2 – 2014 less 2012 WECC PSA

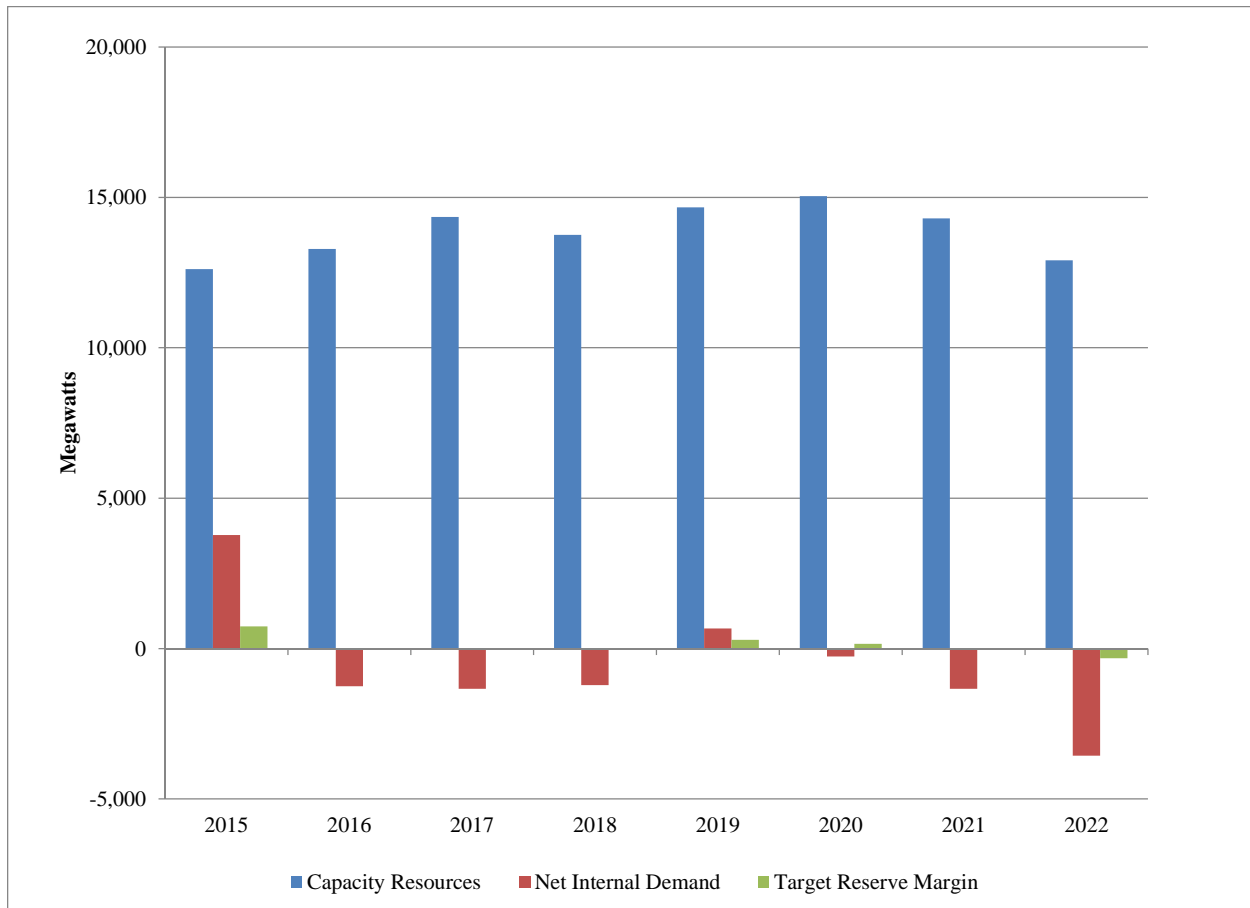

Table J.1 shows the target summer planning reserve margin calculated in the 2014 WECC PSA report, along with the forecasted yearly results. These results are based on the following elements:

- Generation (existing as of December 31, 2013, as well as that under construction);
- Adjustments for scheduled maintenance/inoperable generation;
- Hydro energy under adverse water conditions; and
- Demand forecasts, both firm and non-firm.

The 2014 WECC power reserve margin results show that there is not a resource need through 2024 whereas the 2012 PSA projected a resource need in 2020.

Table J.1 – 2012 WECC Forecasted Planning Reserve Margins

Planning Reserve Margin		Summer; Existing and Class 1 Resources									
Subregion	Target Reserve Margin	2015	2016	2017	2018	2019	2020	2021	2022	2023	2024
NWPP	15.5%	33.6%	32.1%	303.7%	27.3%	27.1%	26.8%	26.6%	25.3%	21.3%	17.7%
RMRG	13.2%	41.7%	58.3%	63.7%	59.6%	53.0%	48.4%	28.4%	13.3%	13.4%	13.3%
SRSR	14.1%	31.8%	38.3%	31.1%	28.2%	21.0%	17.0%	15.1%	14.2%	14.2%	14.1%
CA/MX	15.0%	15.3%	16.0%	15.9%	15.4%	15.4%	15.3%	15.3%	15.2%	15.1%	15.1%
WECC Total	14.7%	27.3%	28.9%	27.6%	25.3%	23.8%	22.7%	21.1%	19.4%	17.6%	16.0%

Northwest Power Pool (NWPP) is a winter peaking WECC sub region comprised of Washington, Oregon, Idaho, Montana, Nevada, Utah, western Wyoming, Alberta, British Columbia and the

Balancing Authority of Northern California. The target summer reserve margin for this region is 15.5%, which is well below the region’s forecasted planning reserve margin for 2015-2024.

Market depth refers to a market’s ability to accept individual transactions without a perceptible change in market price. While different from market liquidity⁴⁴ the two are linked in that a deep market tends to be a liquid market. Electricity market depth is a function of the number of economic agents, market period, generating capacity, transmission capability, transparency, and institutional and/or physical constraints. Based on the 2014 PSA, WECC maintains a positive power supply margin (PSM) through 2024. All of the WECC’s sub regions also are forecasted to maintain sufficient PSM through 2024. In total, known market transactions, generation resources, load requirements, and the optimization of transfers within WECC show adequate market depth to maintain target reserve margins for several years.

Pacific Northwest Resource Adequacy Forum’s Adequacy Assessment

The Pacific Northwest Resource Adequacy Forum issued resource adequacy standards in April 2008, which were subsequently adopted by the Northwest Power and Conservation Council. The standard calls for assessments three and five years out, conducted every year, and including only existing resources and planned resources that are already sited and licensed. In a May 2014 report, the Forum concluded that the likelihood of a shortfall between the region’s winter power supply and forecasted load growth 5 years out had decreased from 6.6 percent to 6 percent.⁴⁵ This means that the region will still have to acquire additional resources in the winter period in order to maintain an adequate power supply⁴⁶, a finding that supports acquisition actions currently being taken by regional utilities. Between 2017 and 2019, the region’s electricity loads, net of planned energy efficiency savings, are expected to grow by about 130 average megawatts or about a 0.6 percent annual rate. Since the last assessment, 667 megawatts of new thermal capacity and 267 megawatts of new wind capacity have been added. There are a host of solutions which would get the targeted loss of load probability down to five percent. Adding 400 MWs of dispatchable generation by 2019 would suffice, as would reducing annual load by 300 average megawatts. WECC’s 2014 PSA shows a combination of lowering loads and increasing supply in future years.

Customer versus Shareholder Risk Allocation

Market purchase costs are reflected in rates. Consequently, customers bear the price risk of the Company’s reliance on a given level of market purchases. However, customers also bear the cost impact of the Company's decision to build or acquire resources if those resources exceed market alternatives and result in an increase in rates. These offsetting risks stress the need for robust IRP analysis, efficient RFPs and ability to capture opportunistic procurement opportunities when they arise.

⁴⁴ Market liquidity refers to having ready and willing buyers and sellers for large transactions.

⁴⁵ Pacific Northwest Power Supply Adequacy Assessment for 2017, at <https://www.nwcouncil.org/energy/powersupply/2014-04/>

⁴⁶ A five percent loss of load probability has been deemed, by the Pacific Northwest Power Council, as the maximum tolerable level.

APPENDIX K – DETAIL CAPACITY EXPANSION RESULTS

Portfolio Case Build Tables

This section provides the System Optimizer portfolio build tables for each of the case scenarios as described in the portfolio development section of Chapter 7. There are 30 core cases. The different cases were run under one of three Regional Haze scenarios.

Table K.1 – Core Case Study Reference Guide

Case	Reg. Haze [1]	111(d) Def. [2]	111(d) Strat. [3]	CO ₂ Price	Class 2 DSM [4]	FOTs	1 st Year of New Thermal
C01-R	Ref	None	None	None	Base	Base	2028
C01-1	1	None	None	None	Base	Base	2024
C01-2	2	None	None	None	Base	Base	2024
C02-1	1	1	A	None	Base	Base	2024
C02-2	2	1	A	None	Base	Base	2024
C03-1	1	1	B	None	Base+	Base	2028
C03-2	2	1	B	None	Base+	Base	2025
C04-1	1	1	C	None	Base+	Base	2028
C04-2	2	1	C	None	Base+	Base	2025
C05-1	1	2	A	None	Base	Base	2024
C05-2	2	2	A	None	Base	Base	2024
C05-3	3	2	A	None	Base	Base	2028
C05a-1	1	2	A	None	Base	Base	2024
C05b-1	1	2	A	None	Base	Base	2024
C05a-2	2	2	A	None	Base	Base	2024
C05a-3	3	2	A	None	Base	Base	2028
C05a-3Q	3	2	A	None	Base	Base	2028
C05b-3	3	2	A	None	Base	Base	2028
C06-1	1	2	B	None	Base+	Base	2028
C06-2	2	2	B	None	Base+	Base	2025
C07-1	1	2	C	None	Base+	Base	2028
C07-2	2	2	C	None	Base+	Base	2025
C09-1	1	2	A	None	Base	Limited	2022
C09-2	2	2	A	None	Base	Limited	2022
C11-1	1	2	A	None	Accelerated	Base	2024
C11-2	2	2	A	None	Accelerated	Base	2024
C12-1	1	3a	None	None	Base	Base	2024
C12-2	2	3a	None	None	Base	Base	2024
C13-1	1	3b	None	None	Base	Base	2023
C13-2	2	3b	None	None	Base	Base	2023
C14-1	1	2	A	Yes	Base	Base	2024
C14-2	2	2	A	Yes	Base	Base	2024
C14a-1	1	2	A	Yes	Base	Base	2022
C14a-2	2	2	A	Yes	Base	Base	2022

[1] Regional Haze assumptions are defined in the Core Case Fact Sheet for each case.

[2] 1 = 111(d) emission rate targets applied to PacifiCorp’s system for states in which PacifiCorp has fossil generation; 2 = 111(d) emission rate targets applied to PacifiCorp’s system for states in which PacifiCorp has fossil generation and retail customers; 3a = 111(d) implemented as a mass cap applicable to new and existing fossil resources in PacifiCorp’s system; 3b = 111(d) implemented as a mass cap applicable to existing fossil resources in PacifiCorp’s system

[3] A = cost-effective energy efficiency, fossil re-dispatch before adding new renewables; B = increased energy efficiency, fossil re-

dispatch before adding new renewables; C = increased energy efficiency, new renewables before fossil re-dispatch

[4] Base = base Class 2 DSM achievable potential supply curves; Base+ = base Class 2 DSM achievable potential supply curves with forced selections of approximately 1.5% of retail sales; Accelerated = accelerated Class 2 DSM achievable potential supply curves

Table K.2 – Sensitivity Case Study Reference Guide

Case	Description	Reg. Haze[1]	111(d) Strat. [2]	CO ₂ Price	Class 2 DSM [3]	1 st Year of New Thermal
S-01	Low Load	1	A	None	Base	2028
S-02	High Load	1	A	None	Base	2020
S-03	1-in-20 Load	1	A	None	Base	2019
S-04	Low DG	1	A	None	Base	2024
S-05	High DG	1	A	None	Base	2027
S-06	Pumped Storage	1	A	None	Base	2028
S-07	Energy Gateway 2	1	C	None	Base+	2028
S-08	Energy Gateway 5	1	C	None	Base+	2028
S-09	PTC Extension	1	A	None	Base	2024
S-10_ECA	East BAA	3	A	None	Base	2028
S-10_WCA	West BAA	3	A	None	Base	2020
S-10_System	Benchmark System	3	A	None	Base	2028
S-11	111(d) and High CO ₂ Price	1	A	High	Base	2024
S-12	Stakeholder Solar Cost Assumptions	1	A	None	Base	2027
S-13	Compressed Air Storage	1	A	None	Base	2027
S-14	Class 3 DSM	1	A	None	Base	2024
S-15	Restricted 111(d) Attributes	1	A	None	Base	2020

[1] Regional Haze assumptions are defined in the Core Case Fact Sheet for each case.

[2] A = cost-effective energy efficiency, fossil re-dispatch before adding new renewables; C = increased energy efficiency, new renewables before fossil re-dispatch

[3] Base = base Class 2 DSM achievable potential supply curves; Base+ = base Class 2 DSM achievable potential supply curves with forced selections of approximately 1.5% of retail sales;

Additional notes:

All Sensitivities incorporate: 111(d) emission rate targets applied to PacifiCorp's system for states in which PacifiCorp has fossil generation and retail customers;

Table K.3 – East-Side Resource Name and Description

Resource List	Detailed Description
CCCT - DJohns - F 1x1	Combine Cycle Combustion Turbine F-Machine 1x1 with Duct Firing - Dave Johnston Brownfield
CCCT - DJohns - F 2x1	Combine Cycle Combustion Turbine F-Machine 2x1 with Duct Firing - Dave Johnston Brownfield
CCCT - DJohns - G 1x1	Combine Cycle Combustion Turbine GH-Machine 1x1 with Duct Firing - Dave Johnston Brownfield
CCCT - DJohns - G 2x1	Combine Cycle Combustion Turbine GH-Machine 2x1 with Duct Firing - Dave Johnston Brownfield
CCCT - DJohns - J 1x1	Combine Cycle Combustion Turbine J-Machine 1x1 with Duct Firing - Dave Johnston Brownfield
CCCT - Goshen - F 1x1	Combine Cycle Combustion Turbine F-Machine 1x1 with Duct Firing - West Box Elder, Utah Area
CCCT - Goshen - G 1x1	Combine Cycle Combustion Turbine GH-Machine 1x1 with Duct Firing - West Box Elder, Utah Area
CCCT - Goshen - J 1x1	Combine Cycle Combustion Turbine J-Machine 1x1 with Duct Firing - West Box Elder, Utah Area
CCCT - Hunter - F 1x1	Combine Cycle Combustion Turbine F-Machine 1x1 with Duct Firing - Hunter Plant Brownfield
CCCT - Hunter - F 2x1	Combine Cycle Combustion Turbine F-Machine 2x1 with Duct Firing - Hunter Plant Brownfield
CCCT - Hunter - G 1x1	Combine Cycle Combustion Turbine GH-Machine 1x1 with Duct Firing - Hunter Plant Brownfield
CCCT - Hunter - G 2x1	Combine Cycle Combustion Turbine GH-Machine 2x1 with Duct Firing - Hunter Plant Brownfield
CCCT - Hunter - J 1x1	Combine Cycle Combustion Turbine J-Machine 1x1 with Duct Firing - Hunter Plant Brownfield
CCCT - Huntington - F 1x1	Combine Cycle Combustion Turbine F-Machine 1x1 with Duct Firing - Huntington Plant Brownfield
CCCT - Huntington - F 2x1	Combine Cycle Combustion Turbine F-Machine 2x1 with Duct Firing - Huntington Plant Brownfield
CCCT - Huntington - G 1x1	Combine Cycle Combustion Turbine GH-Machine 1x1 with Duct Firing - Huntington Plant Brownfield
CCCT - Huntington - G 2x1	Combine Cycle Combustion Turbine GH-Machine 2x1 with Duct Firing - Huntington Plant Brownfield
CCCT - Huntington - J 1x1	Combine Cycle Combustion Turbine J-Machine 1x1 with Duct Firing - Huntington Plant Brownfield
CCCT - Naughton - J 1x1	Combine Cycle Combustion Turbine J-Machine 1x1 with Duct Firing - Naughton Plant Brownfield
CCCT F 2x1	Combine Cycle Combustion Turbine F-Machine 2x1 with Duct Firing
CCCT FD 1x1	Combine Cycle Combustion Turbine F-Machine 1x1 with Duct Firing
CCCT GH 1x1	Combine Cycle Combustion Turbine GH-Machine 1x1 with Duct Firing
CCCT GH 2x1	Combine Cycle Combustion Turbine GH-Machine 2x1 with Duct Firing
CCCT J 1x1	Combine Cycle Combustion Turbine J-Machine 1x1 with Duct Firing
IC Aero UT	Inter-cooled Simple Cycle Combustion Turbine Aero - Utah
IC Aero WYNE	Inter-cooled Simple Cycle Combustion Turbine Aero - Wyoming NE
IC Aero WYSW	Inter-cooled Simple Cycle Combustion Turbine Aero - Wyoming SW
SCCT Aero UT	Simple Cycle Combustion Turbine Aero - Utah
SCCT Aero WYNE	Simple Cycle Combustion Turbine Aero - Wyoming NE
SCCT Frame ID	Simple Cycle Combustion Turbine Frame - West Box Elder, Utah Area
SCCT Frame UT	Simple Cycle Combustion Turbine Frame - Utah
SCCT Frame WYNE	Simple Cycle Combustion Turbine Frame - Wyoming NE
SCCT Frame WYSW	Simple Cycle Combustion Turbine Frame - Wyoming SW
Battery Storage - East	Battery Storage – East
CAES - East	Compressed Air Energy Storage
Fly Wheel - East	Fly Wheel – East

Resource List	Detailed Description
Pump Storage - East	Pump Storage – East
Reciprocating Engine - East	Reciprocating Engine
Modular-Nuclear-East	Small Modular Reactor x 12 Nuclear
Nuclear - East	Advanced Fission Nuclear
Fuel Cell - East	Fuel Cell – East
Wind, DJohnston, 43	Wind, Wyoming After DJ Retirement, 43% Capacity Factor
Wind, GO, 31	Wind, Goshen Idaho, 31% Capacity Factor
Wind, UT, 31	Wind, Utah, 31% Capacity Factor
Wind, WYAE, 43	Wind, Wyoming Aeolius, 43% Capacity Factor
Utility Solar - PV - East	Utility Solar, Utah - Photovoltaic
DSM, Class 1, ID-Curtail	DSM Class 1, Curtailment - Idaho
DSM, Class 1, ID-DLC-RES	DSM Class 1, Direct Load Control-Residential - Idaho
DSM, Class 1, ID-Irrigate	DSM Class 1, Direct Load Control-Irrigation - Idaho
DSM, Class 1, UT-Curtail	DSM Class 1, Curtailment - Utah
DSM, Class 1, UT-DLC-RES	DSM Class 1, Direct Load Control-Residential - Utah
DSM, Class 1, UT-Irrigate	DSM Class 1, Direct Load Control-Irrigation - Utah
DSM, Class 1, WY-Curtail	DSM Class 1, Curtailment - Wyoming
DSM, Class 1, WY-DLC-RES	DSM Class 1, Direct Load Control-Residential - Wyoming
DSM, Class 1, WY-Irrigate	DSM Class 1, Direct Load Control-Irrigation - Wyoming
DSM, Class 3, ID-C&I Pricing	DSM Class 3, Commercial & Industrial Pricing - Idaho
DSM, Class 3, ID-C&I Demand Buyback	DSM Class 3, Commercial & Industrial Demand Buyback - Idaho
DSM, Class 3, ID-Irrigate Price	DSM Class 3, Irrigation Pricing - Idaho
DSM, Class 3, ID-Res Price	DSM Class 3, Residential Pricing - Idaho
DSM, Class 3, UT-C&I Pricing	DSM Class 3, Commercial & Industrial Pricing - Utah
DSM, Class 3, UT-C&I Demand Buyback	DSM Class 3, Commercial & Industrial Demand Buyback - Utah
DSM, Class 3, UT-Irrigate Price	DSM Class 3, Irrigation Pricing - Utah
DSM, Class 3, UT-Res Price	DSM Class 3, Residential Pricing - Utah
DSM, Class 3, WY-C&I Pricing	DSM Class 3, Commercial & Industrial Pricing - Wyoming
DSM, Class 3, WY-C&I Demand Buyback	DSM Class 3, Commercial & Industrial Demand Buyback - Wyoming
DSM, Class 3, WY-Irrigate Price	DSM Class 3, Irrigation Pricing - Wyoming
DSM, Class 3, WY-Res Price	DSM Class 3, Residential Pricing - Wyoming
DSM, Class 2, ID	DSM, Class 2, Idaho
DSM, Class 2, UT	DSM, Class 2, Utah
DSM, Class 2, WY	DSM, Class 2, Wyoming
FOT Mona Q3	Front Office Transaction - 3rd Quarter HLH Product - Mona

Table K.4 – West-Side Resource Name and Description

Resource List	Detailed Description
CCCT F 2x1	Combine Cycle Combustion Turbine F-Machine 2x1 with Duct Firing
CCCT GH 1x1	Combine Cycle Combustion Turbine GH-Machine 1x1 with Duct Firing
CCCT GH 2x1	Combine Cycle Combustion Turbine GH-Machine 2x1 with Duct Firing
CCCT J 1x1	Combine Cycle Combustion Turbine J-Machine 1x1 with Duct Firing
IC Aero WV	Inter-cooled Simple Cycle Combustion Turbine Aero - Willamette Valley
IC Aero WW	Inter-cooled Simple Cycle Combustion Turbine Aero - Walla Walla
IC Aero PO	Inter-cooled Simple Cycle Combustion Turbine Aero - Portland
IC Aero SO-CAL	Inter-cooled Simple Cycle Combustion Turbine Aero - Southern Oregon
SCCT Aero PO	Simple Cycle Combustion Turbine Aero - Portland
SCCT Aero WV	Simple Cycle Combustion Turbine Aero - Willamette Valley
SCCT Aero WW	Simple Cycle Combustion Turbine Aero - Walla Walla
SCCT Frame WW	Simple Cycle Combustion Turbine Frame - Walla Walla
Fly Wheel	Fly Wheel
Battery Storage	Battery Storage
Pump Storage	Pump Storage
Utility Solar - PV	Utility Solar - Photovoltaic
OR Solar (Util Cap Standard & Cust Incentive Prgm)	OR Solar (Utility Solar Capacity Standard & Customer Incentive Program)
Wind, YK, 29	Wind, Arlington, OR, 29% Capacity Factor
Wind, WW, 29	Wind, Walla Walla, 29% Capacity Factor
DSM, Class 1, CA-Curtail	DSM Class 1, Curtailment - California
DSM, Class 1, CA-DLC-IRR	DSM Class 1, Direct Load Control-Irrigation - California
DSM, Class 1, CA-DLC-RES	DSM Class 1, Direct Load Control-Residential - California
DSM, Class 1, OR-Curtail	DSM Class 1, Curtailment - Oregon
DSM, Class 1, OR-DLC-IRR	DSM Class 1, Direct Load Control-Irrigation - Oregon
DSM, Class 1, OR-DLC-RES	DSM Class 1, Direct Load Control-Residential - Oregon
DSM, Class 1, WA-Curtail	DSM Class 1, Curtailment - Washington
DSM, Class 1, WA-DLC-IRR	DSM Class 1, Direct Load Control-Irrigation - Washington
DSM, Class 1, WA-DLC-RES	DSM Class 1, Direct Load Control-Residential - Washington
DSM, Class 3, CA-C&I Pricing	DSM Class 3, Commercial & Industrial Pricing - California
DSM, Class 3, CA-C&I Demand Buyback	DSM Class 3, Commercial & Industrial Demand Buyback - California
DSM, Class 3, CA-Irrigate Price	DSM Class 3, Irrigation Pricing - California
DSM, Class 3, CA-Res Price	DSM Class 3, Residential Pricing - California
DSM, Class 3, OR-C&I Pricing	DSM Class 3, Commercial & Industrial Pricing - Oregon
DSM, Class 3, OR-C&I Demand Buyback	DSM Class 3, Commercial & Industrial Demand Buyback - Oregon
DSM, Class 3, OR-Irrigate Price	DSM Class 3, Irrigation Pricing - Oregon

Resource List	Detailed Description
DSM, Class 3, OR-Res Price	DSM Class 3, Residential Pricing - Oregon
DSM, Class 3, WA-C&I Pricing	DSM Class 3, Commercial & Industrial Pricing - Washington
DSM, Class 3, WA-C&I Demand Buyback	DSM Class 3, Commercial & Industrial Demand Buyback - Washington
DSM, Class 3, WA-Irrigate Price	DSM Class 3, Irrigation Pricing - Washington
DSM, Class 3, WA-Res Price	DSM Class 3, Residential Pricing - Washington
DSM, Class 2, CA	DSM, Class 2, California
DSM, Class 2, OR	DSM, Class 2, Oregon
DSM, Class 2, WA	DSM, Class 2, Washington
FOT COB Flat	Front Office Transaction – Annual Flat Product - COB
FOT COB Q3	Front Office Transaction - 3rd Quarter HLH Product - COB
FOT MidColumbia Flat	Front Office Transaction - Annual Flat Product - Mid Columbia
FOT MidColumbia Q3	Front Office Transaction - 3rd Quarter HLH Product - Mid Columbia
FOT MidColumbia Q3 - 2	Front Office Transaction - 3rd Quarter HLH Product - Mid Columbia
FOT NOB Q3	Front Office Transaction - 3rd Quarter HLH Product - Nevada Oregon Border
FOT COB - Jan	Front Office Transaction - January HLH Product - COB
FOT MidColumbia - Jan	Front Office Transaction - January HLH Product - Mid Columbia
FOT MidColumbia - Jan - 2	Front Office Transaction - January HLH Product - Mid Columbia
FOT NOB - Jan	Front Office Transaction - January HLH Product - Nevada Oregon Border

Table K.5 – Core Case System Optimizer Results

Case	PVRR (\$M)	Cumulative CO2 Emissions (Thousand Short Tons)
C01-R	26,828	969,315
C01-1	26,683	897,452
C02-1	27,787	825,935
C03-1	28,889	809,295
C04-1	29,310	865,036
C05-1	26,646	890,106
C05a-1	26,591	879,838
C05b-1	26,649	885,644
C06-1	27,930	875,231
C07-1	28,516	873,897
C09-1	26,809	895,314
C11-1	26,649	889,635
C12-1	26,655	862,398
C13-1	26,902	839,068
C14-1	39,442	812,401
C14a-1	39,304	762,475
C01-2	27,254	849,333
C02-2	28,313	781,935
C03-2	29,509	767,859
C04-2	29,913	822,396
C05-2	27,177	845,522
C05a-2	27,240	832,613
C06-2	28,549	832,553
C07-2	29,115	830,308
C09-2	27,454	850,072
C11-2	27,175	844,736
C12-2	27,241	821,818
C13-2	27,360	807,512
C14-2	39,584	772,949
C14a-2	39,347	747,893
C05-3	26,615	920,441
C05a-3	26,578	906,487
C05a-3Q, Preferred Portfolio	26,591	903,937
C05b-3	26,649	912,759

Table K.6 – Sensitivity Case System Optimizer Results

Sensitivity	PVRR (\$M)	Cumulative CO2 Emissions (Thousand Short Tons)
S-01	24,715	865,610
S-02	28,334	914,156
S-03	27,709	892,507
S-04	26,885	895,085
S-05	26,016	878,263
S-06	27,094	881,487
S-07	29,227	876,749
S-08	29,977	871,943
S-09	26,443	886,173
S-10_ECA	19,672	667,684
S-10_System	26,480	905,154
S-10_WCA	8,129	250,205
S-11	45,091	642,166
S-12	26,029	878,261
S-13	27,046	882,676
S-14	26,602	887,261
S-15	27,057	882,840

Table K.7 – Core Cases, Detailed Capacity Expansion Portfolios

Case C01-R		Capacity (MW)																				Resource Totals 1/								
		2015	2016	2017	2018	2019	2020	2021	2022	2023	2024	2025	2026	2027	2028	2029	2030	2031	2032	2033	2034	10-year	20-year							
East	Existing Plant Retirements/Conversions	-	-	-	-	-	-	-	-	-	-	-	-	-	-	-	-	-	-	-	(45)	-	-	-	-	-	(45)			
	Hayden 1	-	-	-	-	-	-	-	-	-	-	-	-	-	-	-	-	-	-	-	-	(33)	-	-	-	-	-	(33)		
	Hayden 2	(67)	-	-	-	-	-	-	-	-	-	-	-	-	-	-	-	-	-	-	-	-	-	-	-	-	(67)	(67)		
	Carbon 1 (Coal Early Retirement/Conversions)	(105)	-	-	-	-	-	-	-	-	-	-	-	-	-	-	-	-	-	-	-	-	-	-	-	-	(105)	(105)		
	Carbon 2 (Coal Early Retirement/Conversions)	-	-	-	-	-	-	-	-	-	-	-	-	-	-	-	-	-	-	-	-	-	-	-	-	-	-	(106)	(106)	
	DaveJohnston 1	-	-	-	-	-	-	-	-	-	-	-	-	-	-	(106)	-	-	-	-	-	-	-	-	-	-	-	(106)	(106)	
	DaveJohnston 2	-	-	-	-	-	-	-	-	-	-	-	-	-	-	(106)	-	-	-	-	-	-	-	-	-	-	-	-	(106)	(106)
	DaveJohnston 3	-	-	-	-	-	-	-	-	-	-	-	-	-	-	(218)	-	-	-	-	-	-	-	-	-	-	-	-	(218)	(218)
	DaveJohnston 4	-	-	-	-	-	-	-	-	-	-	-	-	-	-	(330)	-	-	-	-	-	-	-	-	-	-	-	-	(330)	(330)
	Naughton 1	-	-	-	-	-	-	-	-	-	-	-	-	-	-	-	-	(156)	-	-	-	-	-	-	-	-	-	-	(156)	(156)
	Naughton 2	-	-	-	-	-	-	-	-	-	-	-	-	-	-	-	-	(201)	-	-	-	-	-	-	-	-	-	-	(201)	(201)
	Naughton 3 (Coal Early Retirement/Conversions)	(50)	-	-	(280)	-	-	-	-	-	-	-	-	-	-	-	-	-	-	-	-	-	-	-	-	-	-	(330)	(330)	
	Gadsby 1-6	-	-	-	-	-	-	-	-	-	-	-	-	-	-	-	-	-	-	-	-	-	-	-	(358)	-	-	-	(358)	(358)
	Coal Ret_AZ - Gas RePower	-	-	-	-	-	-	-	-	-	-	-	-	-	-	-	-	-	-	-	-	-	-	-	-	-	-	-	-	-
	Coal Ret_WY - Gas RePower	-	-	-	337	-	-	-	-	-	-	-	-	-	-	-	-	-	(337)	-	-	-	-	-	-	-	-	337	-	-
	Expansion Resources																													
	CCCT - DJohas - F 1xl	-	-	-	-	-	-	-	-	-	-	-	-	-	-	-	-	313	-	-	-	-	-	-	-	-	-	-	313	313
	CCCT - DJohas - J 1xl	-	-	-	-	-	-	-	-	-	-	-	-	-	-	423	-	-	-	-	-	-	-	-	-	-	-	-	423	423
	CCCT - Naughton - J 1xl	-	-	-	-	-	-	-	-	-	-	-	-	-	-	-	-	-	-	-	-	-	-	-	-	401	-	401	401	401
	CCCT - Utah-S - F 2xl	-	-	-	-	-	-	-	-	-	-	-	-	-	-	-	-	-	-	635	-	-	-	-	-	-	-	-	635	635
	Total CCCT	-	-	-	-	-	-	-	-	-	-	-	-	-	-	423	-	313	-	635	-	-	-	-	-	401	-	-	1,772	1,772
	Wind, DJohnston, 43	-	-	-	-	-	-	-	-	-	-	-	-	-	-	25	-	-	-	-	-	-	-	-	-	-	-	25	25	
	Total Wind	-	-	-	-	-	-	-	-	-	-	-	-	-	-	25	-	-	-	-	-	-	-	-	-	-	-	25	25	
	Utility Solar - PV - East	-	-	-	-	-	-	-	-	238	-	-	-	-	-	-	-	-	-	-	-	-	-	-	-	-	-	238	238	
	DSM, Class 1, ID-Irrigate	-	-	-	-	-	-	-	-	-	-	-	-	-	-	-	-	20.0	-	-	-	-	-	-	-	-	-	20.0	20.0	
	DSM, Class 1, UT-DLC-RES	-	-	-	-	-	-	-	-	-	-	-	-	-	-	-	-	57.8	-	-	-	-	-	-	-	-	-	57.8	57.8	
	DSM, Class 1, UT-Irrigate	-	-	-	-	-	-	-	-	-	-	-	-	-	-	-	-	16.5	-	-	-	-	-	-	-	-	-	16.5	16.5	
	DSM, Class 1 Total	-	-	-	-	-	-	-	-	-	-	-	-	-	-	-	-	94.2	-	-	-	-	-	-	-	-	-	94.2	94.2	
	DSM, Class 2, ID	4	4	5	5	5	4	4	4	6	6	5	5	5	5	5	5	5	4	4	4	4	4	4	4	4	4	47	93	
	DSM, Class 2, UT	69	78	84	86	92	80	86	93	99	105	85	85	84	84	83	77	66	65	63	64	64	64	64	64	64	871	1,626		
	DSM, Class 2, WY	7	8	10	12	14	12	13	14	15	16	13	14	14	16	15	16	14	15	15	15	15	15	15	15	122	270	270		
	DSM, Class 2 Total	79	90	99	102	111	97	103	112	120	127	103	104	104	105	103	97	84	84	82	83	83	83	83	83	1,040	1,989	1,989		
	FOT Mona Q3	-	-	-	-	-	-	-	-	-	-	-	-	-	-	137	75	295	295	75	175	143	-	-	-	-	60	60	60	
West																														
Expansion Resources																														
Oregon Solar Capacity Standard	-	7	-	-	-	-	-	-	-	-	-	-	-	-	-	-	-	-	-	-	-	-	-	-	-	7	7	7		
DSM, Class 1, OR-Curtail	-	-	-	-	-	-	-	-	-	10.6	-	-	10.6	-	-	-	10.6	-	-	-	-	-	-	-	-	10.6	31.8	31.8		
DSM, Class 1, OR-Irrigate	-	-	-	-	-	-	-	-	3.4	5.0	-	-	-	-	-	-	-	-	-	-	-	-	-	-	-	8.4	8.4	8.4		
DSM, Class 1 Total	-	-	-	-	-	-	-	-	3.4	15.6	-	-	10.6	-	-	-	10.6	-	-	-	-	-	-	-	-	19.0	40.2	40.2		
DSM, Class 2, CA	1	2	2	2	2	1	1	2	2	2	1	1	1	2	2	1	1	1	1	1	1	1	1	1	1	16	30	30		
DSM, Class 2, OR	44	39	35	32	29	27	25	25	23	24	22	22	22	23	22	21	20	20	19	19	19	19	19	19	19	303	512	512		
DSM, Class 2, WA	8	9	10	10	11	9	10	10	11	11	9	9	9	9	9	8	8	8	7	7	7	7	7	7	98	182	182			
DSM, Class 2 Total	54	50	47	44	42	38	36	36	36	36	32	33	32	34	33	30	29	29	27	27	27	27	27	27	418	724	724			
FOT COB Q3	-	92	148	113	181	224	-	-	-	-	-	-	-	-	268	196	268	268	72	268	268	76	76	76	76	118	118	118		
FOT MidColumbia Q3	400	400	400	400	400	400	400	400	400	400	400	400	400	400	400	400	400	400	400	400	400	400	400	400	400	400	400	400	400	
FOT MidColumbia Q3 - 2	227	375	375	375	375	375	279	312	257	250	266	287	321	375	375	375	375	375	375	375	375	375	375	375	375	375	375	375	375	
FOT NOB Q3	100	100	100	100	100	100	100	100	100	100	100	100	100	100	100	100	100	100	100	100	100	100	100	100	100	100	100	100	100	
Existing Plant Retirements/Conversions	(222)	-	-	57	-	-	-	-	-	-	-	-	-	-	(760)	-	(694)	(77)	-	(358)	-	-	-	-	-	-	-	-		
Annual Additions, Long Term Resources	133	147	146	146	153	135	139	151	409	163	134	147	136	586	136	546	113	748	110	511	-	-	-	-	-	-	-	-		
Annual Additions, Short Term Resources	727	967	1,023	988	1,056	1,099	779	812	757	750	766	787	821	1,280	1,146	1,438	1,438	1,022	1,318	1,286	-	-	-	-	-	-	-	-		
Total Annual Additions	860	1,114	1,169	1,134	1,209	1,234	918	964	1,166	913	900	934	957	1,866	1,282	1,984	1,552	1,770	1,428	1,797	-	-	-	-	-	-	-	-		

1/ Front office transaction amounts reflect one-year transaction periods, are not additive, and are reported as a 10/20-year annual average.

Case C01-1		Capacity (MW)																			Resource Totals 1/		
		2015	2016	2017	2018	2019	2020	2021	2022	2023	2024	2025	2026	2027	2028	2029	2030	2031	2032	2033	2034	10-year	20-year
East	Existing Plant Retirements/Conversions																						
	Hayden 1	-	-	-	-	-	-	-	-	-	-	-	-	-	-	-	-	(45)	-	-	-	-	(45)
	Hayden 2	-	-	-	-	-	-	-	-	-	-	-	-	-	-	-	-	(33)	-	-	-	-	(33)
	Hunter 2 (Coal Early Retirement/Conversions)	-	-	-	-	-	-	-	-	-	-	-	-	-	-	-	-	-	-	(269)	-	-	(269)
	Huntington 2 (Coal Early Retirement/Conversions)	-	-	-	-	-	-	-	(450)	-	-	-	-	-	-	-	-	-	-	-	-	(450)	(450)
	Carbon 1 (Coal Early Retirement/Conversions)	(67)	-	-	-	-	-	-	-	-	-	-	-	-	-	-	-	-	-	-	-	(67)	(67)
	Carbon 2 (Coal Early Retirement/Conversions)	(105)	-	-	-	-	-	-	-	-	-	-	-	-	-	-	-	-	-	-	-	(105)	(105)
	Cholla 4 (Coal Early Retirement/Conversions)	-	-	-	-	-	-	-	-	-	-	(387)	-	-	-	-	-	-	-	-	-	-	(387)
	DaveJohnston 1 (Coal Early Retirement/Conversions)	-	-	-	-	(106)	-	-	-	-	-	-	-	-	-	-	-	-	-	-	-	(106)	(106)
	DaveJohnston 2	-	-	-	-	-	-	-	-	-	-	-	-	-	(106)	-	-	-	-	-	-	-	(106)
	DaveJohnston 3	-	-	-	-	-	-	-	-	-	-	-	-	-	(220)	-	-	-	-	-	-	-	(220)
	DaveJohnston 4	-	-	-	-	-	-	-	-	-	-	-	-	-	-	-	-	-	(330)	-	-	-	(330)
	Naughton 1	-	-	-	-	-	-	-	-	-	-	-	-	-	-	-	(156)	-	-	-	-	-	(156)
	Naughton 2	-	-	-	-	-	-	-	-	-	-	-	-	-	-	-	(201)	-	-	-	-	-	(201)
	Naughton 3 (Coal Early Retirement/Conversions)	(50)	-	-	(280)	-	-	-	-	-	-	-	-	-	-	-	-	-	-	-	-	(330)	(330)
	Cadsby 1-6	-	-	-	-	-	-	-	-	-	-	-	-	-	-	-	-	-	-	(358)	-	-	(358)
	Coal Ret. AZ - Gas RePower	-	-	-	-	-	-	-	-	-	-	387	-	-	-	-	-	-	-	-	-	-	387
	Coal Ret. WY - Gas RePower	-	-	-	337	-	-	-	-	-	-	-	-	-	-	-	(337)	-	-	-	-	337	-
	Expansion Resources																						
	CCCT - DJohns - F 1x1	-	-	-	-	-	-	-	-	-	-	-	-	-	313	-	-	-	-	-	-	-	313
	CCCT - DJohns - J 1x1	-	-	-	-	-	-	-	-	-	-	-	-	-	-	-	-	-	-	423	-	-	423
	CCCT - Huntington - J 1x1	-	-	-	-	-	-	-	-	-	-	-	-	-	-	-	423	-	-	-	-	-	423
	CCCT - Naughton - J 1x1	-	-	-	-	-	-	-	-	-	-	-	-	-	-	-	-	-	-	401	-	-	401
	CCCT - Utah-S - J 1x1	-	-	-	-	-	-	-	-	-	-	-	-	-	423	-	-	-	423	-	-	-	846
	Total CCCT	-	-	-	-	-	-	-	-	-	-	-	-	-	736	-	423	-	423	824	-	-	2,406
	Wind, DJohnston, 43	-	-	-	-	-	25	-	-	-	-	-	-	-	-	-	-	-	-	-	-	-	25
	Total Wind	-	-	-	-	-	25	-	-	-	-	-	-	-	-	-	-	-	-	-	-	-	25
	Utility Solar - PV - East	-	-	-	-	-	154	-	-	-	-	-	-	-	-	-	-	-	-	-	-	154	154
	DSM, Class 1, ID-Irrigate	-	-	-	-	-	-	-	-	-	-	-	-	-	-	-	-	-	-	-	25.9	-	25.9
	DSM, Class 1, UT-Irrigate	-	-	-	-	-	-	-	-	-	-	-	-	-	-	-	-	-	-	-	19.0	-	19.0
	DSM, Class 1 Total	-	-	-	-	-	-	-	-	-	-	-	-	-	-	-	-	-	-	-	45.0	-	45.0
	DSM, Class 2, ID	4	4	5	5	5	4	4	4	5	5	4	4	5	5	5	4	4	4	4	4	4	44
	DSM, Class 2, UT	69	78	84	86	92	80	84	87	89	90	73	73	74	75	75	72	71	73	71	73	839	1,568
DSM, Class 2, WY	6	8	10	12	14	12	13	14	15	16	13	13	13	14	14	14	15	16	16	17	121	266	
DSM, Class 2 Total	79	90	99	102	111	97	101	106	108	111	90	90	92	94	93	90	91	93	91	94	1,004	1,922	
FOT Mona Q3	-	-	-	-	11	-	-	127	112	-	83	131	203	44	75	175	170	75	75	300	25	79	
Existing Plant Retirements/Conversions																							
JimBridger 1 (Coal Early Retirement/Conversions)	-	-	-	-	-	-	-	-	-	(354)	-	-	-	-	-	-	-	-	-	-	(354)	(354)	
JimBridger 2 (Coal Early Retirement/Conversions)	-	-	-	-	-	-	-	-	-	-	-	-	-	-	-	-	-	-	(359)	-	-	(359)	
Expansion Resources																							
CCCT - SOregonCal - J 1x1	-	-	-	-	-	-	-	-	-	-	-	-	-	-	-	-	-	-	454	-	-	454	
CCCT - WillamValcc - J 1x1	-	-	-	-	-	-	-	-	-	477	-	-	-	-	-	-	-	-	-	-	477	477	
Total CCCT	-	-	-	-	-	-	-	-	-	477	-	-	-	-	-	-	-	-	454	-	-	932	
Wind, YK, 29	-	-	-	-	-	-	-	-	24	-	-	-	-	-	-	-	-	-	-	-	24	24	
Total Wind	-	-	-	-	-	-	-	-	24	-	-	-	-	-	-	-	-	-	-	-	24	24	
Oregon Solar Capacity Standard	-	7	-	-	-	-	-	-	-	-	-	-	-	-	-	-	-	-	-	-	-	7	
DSM, Class 1, OR-Irrigate	-	-	-	-	-	-	-	3.4	5.0	-	-	-	-	-	-	-	-	-	-	-	-	8.4	
DSM, Class 1 Total	-	-	-	-	-	-	-	3.4	5.0	-	-	-	-	-	-	-	-	-	-	-	-	8.4	
DSM, Class 2, CA	1	2	2	2	2	1	1	2	2	2	1	1	1	1	1	1	1	1	1	1	16	28	
DSM, Class 2, OR	44	39	35	32	29	27	25	25	23	23	21	21	21	21	21	20	20	19	19	302	505		
DSM, Class 2, WA	8	9	10	10	10	9	9	10	11	11	9	9	9	9	9	8	8	8	8	7	97	178	
DSM, Class 2 Total	54	49	47	44	42	38	36	36	36	35	31	31	30	30	31	29	29	28	28	415	711		
FOT COB Q3	-	93	149	114	268	261	-	268	268	264	268	268	268	209	54	268	268	155	230	268	169	197	
FOT MidColumbia Q3	400	400	400	400	400	400	400	400	400	400	400	400	400	400	400	400	400	400	400	400	400	400	
FOT MidColumbia Q3 - 2	227	375	375	375	375	375	314	375	375	375	375	375	375	375	375	375	375	375	375	354	365		
FOT NOB Q3	100	100	100	100	100	100	100	100	100	100	100	100	100	100	100	100	100	100	100	100	100	100	
Existing Plant Retirements/Conversions	(222)	-	-	57	(106)	-	-	(450)	-	(354)	-	-	-	(326)	-	(694)	(77)	-	(1,316)	-	-	-	
Annual Additions, Long Term Resources	132	146	145	146	152	314	137	146	173	623	120	121	122	861	124	542	120	545	1,397	167	-	-	
Annual Additions, Short Term Resources	727	968	1,024	989	1,153	1,136	814	1,270	1,255	1,139	1,226	1,274	1,346	1,128	1,004	1,318	1,312	1,105	1,180	1,443	-	-	
Total Annual Additions	859	1,115	1,170	1,135	1,306	1,450	951	1,416	1,427	1,762	1,346	1,395	1,469	1,989	1,128	1,860	1,432	1,650	2,577	1,610	-	-	

1/ Front office transaction amounts reflect one-year transaction periods, are not additive, and are reported as a 10/20-year annual average.

Case C02-1		Capacity (MW)																			Resource Totals 1/			
		2015	2016	2017	2018	2019	2020	2021	2022	2023	2024	2025	2026	2027	2028	2029	2030	2031	2032	2033	2034	10-year	20-year	
East	Existing Plant Retirements/Conversions																							
	Hayden 1	-	-	-	-	-	-	-	-	-	-	-	-	-	-	-	-	-	(45)	-	-	-	-	(45)
	Hayden 2	-	-	-	-	-	-	-	-	-	-	-	-	-	-	-	-	-	(33)	-	-	-	-	(33)
	Hunter 2 (Coal Early Retirement/Conversions)	-	-	-	-	-	-	-	-	-	-	-	-	-	-	-	-	-	-	-	(269)	-	-	(269)
	Huntington 2 (Coal Early Retirement/Conversions)	-	-	-	-	-	-	-	-	(450)	-	-	-	-	-	-	-	-	-	-	-	-	-	(450)
	Carbon 1 (Coal Early Retirement/Conversions)	(67)	-	-	-	-	-	-	-	-	-	-	-	-	-	-	-	-	-	-	-	-	-	(67)
	Carbon 2 (Coal Early Retirement/Conversions)	(105)	-	-	-	-	-	-	-	-	-	-	-	-	-	-	-	-	-	-	-	-	-	(105)
	Cholla 4 (Coal Early Retirement/Conversions)	-	-	-	-	-	-	-	-	-	-	(387)	-	-	-	-	-	-	-	-	-	-	-	(387)
	DaveJohnston 1 (Coal Early Retirement/Conversions)	-	-	-	-	(106)	-	-	-	-	-	-	-	-	-	-	-	-	-	-	-	-	-	(106)
	DaveJohnston 2	-	-	-	-	-	-	-	-	-	-	-	-	-	(106)	-	-	-	-	-	-	-	-	(106)
	DaveJohnston 3	-	-	-	-	-	-	-	-	-	-	-	-	-	(220)	-	-	-	-	-	-	-	-	(220)
	DaveJohnston 4	-	-	-	-	-	-	-	-	-	-	-	-	-	-	-	-	-	-	(330)	-	-	-	(330)
	Naughton 1	-	-	-	-	-	-	-	-	-	-	-	-	-	-	-	(156)	-	-	-	-	-	-	(156)
	Naughton 2	-	-	-	-	-	-	-	-	-	-	-	-	-	-	-	-	(201)	-	-	-	-	-	(201)
	Naughton 3 (Coal Early Retirement/Conversions)	(50)	-	-	(280)	-	-	-	-	-	-	-	-	-	-	-	-	-	-	-	-	-	-	(330)
	Cadsby 1-6	-	-	-	-	-	-	-	-	-	-	-	-	-	-	-	-	-	-	-	(358)	-	-	(358)
	Coal Ret_AZ - Gas RePower	-	-	-	-	-	-	-	-	-	-	387	-	-	-	-	-	-	-	-	-	-	-	387
	Coal Ret_WY - Gas RePower	-	-	-	337	-	-	-	-	-	-	-	-	-	-	-	-	(337)	-	-	-	-	-	337
	Expansion Resources																							
	CCCT - DJohns - F 1xl	-	-	-	-	-	-	-	-	-	-	-	-	-	-	313	-	-	-	-	-	-	-	313
	CCCT - DJohns - J 1xl	-	-	-	-	-	-	-	-	-	-	-	-	-	-	-	-	-	-	423	-	-	-	423
	CCCT - Huntington - J 1xl	-	-	-	-	-	-	-	-	-	-	-	-	-	-	423	-	-	-	-	-	-	-	423
	CCCT - Naughton - J 1xl	-	-	-	-	-	-	-	-	-	-	-	-	-	-	-	-	-	401	-	-	-	-	401
	CCCT - Utah-N - F 2xl	-	-	-	-	-	-	-	-	-	-	-	-	-	-	-	-	-	-	-	635	-	-	635
	CCCT - Utah-N - J 1xl	-	-	-	-	-	-	-	-	-	-	-	-	-	-	-	-	-	-	423	-	-	-	423
	CCCT - Utah-S - J 1xl	-	-	-	-	-	-	-	-	-	-	423	-	-	-	-	-	423	-	-	-	-	-	423
	Total CCCT	-	-	-	-	-	-	-	-	-	-	423	-	-	-	-	736	-	423	-	401	1,481	-	423
	Wind_DJohnston_43	-	-	-	-	-	25	-	-	-	-	-	-	-	-	-	-	-	-	-	-	-	-	25
	Total Wind	-	-	-	-	-	25	-	-	-	-	-	-	-	-	-	-	-	-	-	-	-	-	25
	Utility Solar - PV - East	-	-	-	-	-	154	-	-	-	-	-	-	-	-	-	-	-	-	-	-	-	-	154
	DSM, Class 2, ID	4	4	5	5	5	4	4	4	5	5	4	4	5	5	5	4	4	4	4	4	4	4	86
	DSM, Class 2, UT	69	78	84	86	92	81	84	87	89	90	73	73	72	72	70	66	65	65	63	64	839	1,522	
	DSM, Class 2, WY	6	8	10	12	14	12	13	14	15	16	13	13	13	14	14	14	15	15	15	15	121	260	
	DSM, Class 2 Total	79	90	99	102	111	97	101	106	108	111	90	90	90	90	88	84	84	84	82	83	1,004	1,868	
	FOT Mona Q3	-	-	-	-	10	-	-	-	-	21	-	44	75	75	44	-	75	44	75	-	275	-	37
	West	Existing Plant Retirements/Conversions																						
		JimBridger 1 (Coal Early Retirement/Conversions)	-	-	-	-	-	-	-	-	-	(354)	-	-	-	-	-	-	-	-	-	-	-	(354)
		JimBridger 2 (Coal Early Retirement/Conversions)	-	-	-	-	-	-	-	-	-	-	-	-	-	-	-	-	-	-	(359)	-	-	(359)
		Expansion Resources																						
		Wind_YK_29	-	-	-	-	-	-	282	-	-	-	-	-	-	-	-	37	-	-	-	-	-	282
		Total Wind	-	-	-	-	-	-	282	-	-	-	-	-	-	-	-	37	-	-	-	-	-	282
		Utility Solar - PV - West	-	-	-	-	-	405	-	-	-	-	-	-	-	-	-	-	-	-	-	-	-	405
		Oregon Solar Capacity Standard	-	7	-	-	-	-	-	-	-	-	-	-	-	-	-	-	-	-	-	-	-	7
		DSM, Class 1, OR-Curtail	-	-	-	-	-	-	-	-	10.6	-	-	10.6	-	-	-	10.6	-	-	-	-	-	10.6
		DSM, Class 1, OR-Irrigate	-	-	-	-	-	-	-	5.0	-	-	3.4	-	-	-	-	-	-	-	-	-	-	5.0
DSM, Class 1 Total		-	-	-	-	-	-	-	5.0	10.6	-	3.4	10.6	-	-	-	10.6	-	-	-	-	-	15.6	
DSM, Class 2, CA		1	2	2	2	2	1	1	2	2	2	1	1	1	1	1	1	1	1	1	1	1	16	
DSM, Class 2, OR		44	39	36	33	29	27	25	25	23	23	21	21	21	21	20	19	20	20	19	19	303	503	
DSM, Class 2, WA		8	9	10	10	10	9	9	10	11	11	9	9	9	9	8	8	8	8	7	7	97	177	
DSM, Class 2 Total		54	49	47	44	42	38	36	36	36	35	31	31	30	30	29	28	29	29	27	27	415	708	
FOT COB Q3		-	93	149	114	268	121	-	186	149	102	142	148	222	38	-	198	218	7	-	-	118	108	
FOT MidColumbia Q3		400	400	400	400	400	400	400	400	400	400	400	400	400	400	400	400	400	400	400	400	400	400	
FOT MidColumbia Q3 - 2		227	375	375	375	375	375	107	375	375	375	375	375	375	375	337	375	375	375	331	375	333	350	
FOT NOB Q3		100	100	100	100	100	100	100	100	100	100	100	100	100	100	100	100	100	100	100	100	100	100	
Existing Plant Retirements/Conversions		(222)	-	-	57	(106)	-	-	(450)	-	(354)	-	-	-	(326)	-	(694)	(77)	-	(1,316)	-	-	-	
Annual Additions, Long Term Resources		133	146	146	146	152	719	419	147	155	569	124	131	121	857	117	572	123	513	1,590	110	-	-	
Annual Additions, Short Term Resources		727	968	1,024	989	1,153	996	607	1,061	1,046	977	1,061	1,098	1,172	957	837	1,148	1,137	957	831	1,150	-	-	
Total Annual Additions		860	1,114	1,170	1,135	1,305	1,715	1,026	1,208	1,200	1,546	1,184	1,229	1,293	1,814	954	1,720	1,261	1,470	2,421	1,259	-	-	

1/ Front office transaction amounts reflect one-year transaction periods, are not additive, and are reported as a 10/20-year annual average.

Case C02-2		Capacity (MW)																			Resource Totals 1/		
		2015	2016	2017	2018	2019	2020	2021	2022	2023	2024	2025	2026	2027	2028	2029	2030	2031	2032	2033	2034	10-year	20-year
East	Existing Plant Retirements/Conversions																						
	Hayden 1	-	-	-	-	-	-	-	-	-	-	-	-	-	-	-	-	(45)	-	-	-	-	(45)
	Hayden 2	-	-	-	-	-	-	-	-	-	-	-	-	-	-	-	-	(33)	-	-	-	-	(33)
	Hunter 2 (Coal Early Retirement/Conversions)	-	-	-	-	-	-	-	-	-	-	(269)	-	-	-	-	-	-	-	-	-	-	(269)
	Huntington 1 (Coal Early Retirement/Conversions)	-	-	-	-	-	-	-	-	-	-	(459)	-	-	-	-	-	-	-	-	-	-	(459)
	Huntington 2 (Coal Early Retirement/Conversions)	-	-	-	-	-	-	-	(450)	-	-	-	-	-	-	-	-	-	-	-	-	(450)	(450)
	Carbon 1 (Coal Early Retirement/Conversions)	(67)	-	-	-	-	-	-	-	-	-	-	-	-	-	-	-	-	-	-	-	(67)	(67)
	Carbon 2 (Coal Early Retirement/Conversions)	(105)	-	-	-	-	-	-	-	-	-	-	-	-	-	-	-	-	-	-	-	(105)	(105)
	Cholla 4 (Coal Early Retirement/Conversions)	-	-	-	-	-	-	-	-	-	-	(387)	-	-	-	-	-	-	-	-	-	-	(387)
	DaveJohnston 1 (Coal Early Retirement/Conversions)	-	-	-	-	(106)	-	-	-	-	-	-	-	-	-	-	-	-	-	-	-	(106)	(106)
	DaveJohnston 2 (Coal Early Retirement/Conversions)	-	-	-	-	-	-	-	-	-	(106)	-	-	-	-	-	-	-	-	-	-	(106)	(106)
	DaveJohnston 3	-	-	-	-	-	-	-	-	-	-	-	-	-	(220)	-	-	-	-	-	-	-	(220)
	DaveJohnston 4	-	-	-	-	-	-	-	-	-	-	-	-	-	-	-	-	-	(330)	-	-	-	(330)
	Naughton 1	-	-	-	-	-	-	-	-	-	-	-	-	-	-	-	(156)	-	-	-	-	-	(156)
	Naughton 2	-	-	-	-	-	-	-	-	-	-	-	-	-	-	-	(201)	-	-	-	-	-	(201)
	Naughton 3 (Coal Early Retirement/Conversions)	(50)	-	-	(280)	-	-	-	-	-	-	-	-	-	-	-	-	-	-	-	-	(330)	(330)
	Wyodak (Coal Early Retirement/Conversions)	-	-	-	-	-	-	-	-	-	-	-	-	-	-	-	-	-	-	(268)	-	-	(268)
	Gadsby 1-6	-	-	-	-	-	-	-	-	-	-	-	-	-	-	-	-	-	(358)	-	-	-	(358)
	Coal Ret. AZ - Gas RePower	-	-	-	-	-	-	-	-	-	-	387	-	-	-	-	-	-	-	-	-	-	387
	Coal Ret. WY - Gas RePower	-	-	-	337	-	-	-	-	-	-	-	-	-	-	-	(337)	-	-	-	-	337	-
	Expansion Resources																						
	CCCT - DJohns - F 2xl	-	-	-	-	-	-	-	-	-	-	-	-	-	-	-	-	-	-	635	-	-	635
	CCCT - Huntington - J 1xl	-	-	-	-	-	-	-	-	-	-	846	-	-	-	-	-	-	-	-	-	-	846
	CCCT - Naughton - J 1xl	-	-	-	-	-	-	-	-	-	-	-	-	-	-	-	401	-	-	-	-	-	401
	CCCT - Utah-N - F 2xl	-	-	-	-	-	-	-	-	-	-	-	-	-	-	635	-	-	-	635	-	-	1,270
	CCCT - Utah-S - J 1xl	-	-	-	-	-	-	-	-	-	423	-	-	423	-	-	-	-	-	-	-	423	846
	Total CCCT	-	-	-	-	-	-	-	-	-	423	846	-	423	-	635	401	-	-	1,270	-	423	3,998
	Wind, DJohnston, 43	-	-	-	-	-	106	-	-	-	-	-	-	-	9	-	-	-	-	-	-	106	115
	Wind, WYAE, 43	-	-	-	-	-	-	-	-	-	-	-	-	-	-	-	12	-	-	-	-	-	12
	Total Wind	-	-	-	-	-	106	-	-	-	-	-	-	-	9	-	12	-	-	-	-	106	127
	Utility Solar - PV - East	-	-	-	-	-	118	-	-	-	-	-	-	-	-	-	-	-	36	-	-	118	154
	DSM, Class 2, ID	4	4	5	5	5	4	4	4	5	6	5	5	5	5	5	4	4	4	4	4	45	91
	DSM, Class 2, UT	69	78	84	86	92	81	86	90	94	93	75	79	80	80	79	73	72	75	70	71	852	1,605
	DSM, Class 2, WY	7	8	10	12	14	12	13	14	15	16	13	13	14	15	15	16	16	17	17	17	121	272
	DSM, Class 2 Total	79	90	99	102	111	97	103	108	114	115	92	97	99	99	98	92	93	96	91	92	1,019	1,967
	FOT Mona Q3	-	-	-	-	9	-	-	-	-	37	-	75	75	-	44	-	75	44	111	60	300	5
	Existing Plant Retirements/Conversions																						
	JimBridger 1 (Coal Early Retirement/Conversions)	-	-	-	-	-	-	-	-	-	(354)	-	-	-	-	-	-	-	-	-	-	(354)	(354)
	JimBridger 2 (Coal Early Retirement/Conversions)	-	-	-	-	-	-	-	-	-	-	-	-	-	-	(359)	-	-	-	-	-	-	(359)
	Expansion Resources																						
	Wind, YK, 29	-	-	-	-	-	-	190	-	-	-	-	-	-	-	-	10	-	-	-	-	190	200
	Total Wind	-	-	-	-	-	-	190	-	-	-	-	-	-	-	-	10	-	-	-	-	190	200
	Utility Solar - PV - West	-	-	-	-	-	405	-	-	-	-	-	-	-	-	-	-	-	-	-	-	405	405
	Oregon Solar Capacity Standard	-	7	-	-	-	-	-	-	-	-	-	-	-	-	-	-	-	-	-	-	7	7
	DSM, Class 1, OR-Curtail	-	-	-	-	-	-	-	-	-	10.6	-	-	10.6	-	-	-	-	10.6	-	-	10.6	31.8
DSM, Class 1, OR-Irrigate	-	-	-	-	-	-	-	5.0	-	-	3.4	-	-	-	-	-	-	-	-	-	5.0	8.4	
DSM, Class 1 Total	-	-	-	-	-	-	-	5.0	10.6	-	3.4	10.6	-	-	-	-	10.6	-	-	-	15.6	40.2	
DSM, Class 2, CA	1	2	2	2	2	1	1	2	2	2	1	1	1	1	1	1	1	1	1	1	16	30	
DSM, Class 2, OR	44	39	36	33	29	27	25	25	23	23	22	22	22	22	21	21	21	20	20	20	303	514	
DSM, Class 2, WA	8	9	10	10	11	9	10	10	11	11	9	9	9	9	8	8	8	8	8	7	98	181	
DSM, Class 2 Total	54	49	47	44	42	38	36	36	36	35	32	32	32	32	30	30	30	28	29	29	417	725	
FOT COB Q3	-	93	148	113	268	123	-	206	149	215	169	200	-	254	-	174	187	268	-	70	131	132	
FOT MidColumbia Q3	400	400	400	400	400	400	400	400	400	400	400	400	400	400	400	400	400	400	400	400	400	400	
FOT MidColumbia Q3 - 2	227	375	375	375	375	375	375	375	375	375	375	375	347	375	308	375	375	375	375	375	336	350	
FOT NOB Q3	100	100	100	100	100	100	100	100	100	100	100	100	100	100	100	100	100	100	100	100	100	100	
Existing Plant Retirements/Conversions	(222)	-	-	57	(106)	-	-	(450)	-	(460)	(728)	-	-	(220)	(359)	(694)	(77)	-	(956)	-	-	-	
Annual Additions, Long Term Resources	133	147	146	147	153	764	329	149	160	573	973	140	554	141	765	545	133	162	1,389	121			
Annual Additions, Short Term Resources	727	968	1,023	988	1,152	998	629	1,081	1,062	1,090	1,119	1,150	847	1,173	808	1,124	1,106	1,254	935	1,245			
Total Annual Additions	860	1,114	1,169	1,134	1,305	1,761	958	1,230	1,221	1,663	2,092	1,290	1,401	1,313	1,573	1,669	1,239	1,415	2,324	1,366			

1/ Front office transaction amounts reflect one-year transaction periods, are not additive, and are reported as a 10-20-year annual average.

Case C03-1		Capacity (MW)																		Resource Totals 1/			
		2015	2016	2017	2018	2019	2020	2021	2022	2023	2024	2025	2026	2027	2028	2029	2030	2031	2032	2033	2034	10-year	20-year
East	Existing Plant Retirements/Conversions																						
	Hayden 1	-	-	-	-	-	-	-	-	-	-	-	-	-	-	-	-	(45)	-	-	-	-	(45)
	Hayden 2	-	-	-	-	-	-	-	-	-	-	-	-	-	-	-	-	(33)	-	-	-	-	(33)
	Hunter 2 (Coal Early Retirement/Conversions)	-	-	-	-	-	-	-	-	-	-	-	-	-	-	-	-	-	-	(269)	-	-	(269)
	Huntington 2 (Coal Early Retirement/Conversions)	-	-	-	-	-	-	-	-	(450)	-	-	-	-	-	-	-	-	-	-	-	(450)	(450)
	Carbon 1 (Coal Early Retirement/Conversions)	(67)	-	-	-	-	-	-	-	-	-	-	-	-	-	-	-	-	-	-	-	-	(67)
	Carbon 2 (Coal Early Retirement/Conversions)	(105)	-	-	-	-	-	-	-	-	-	-	-	-	-	-	-	-	-	-	-	-	(105)
	Cholla 4 (Coal Early Retirement/Conversions)	-	-	-	-	-	-	-	-	-	-	(387)	-	-	-	-	-	-	-	-	-	-	(387)
	DaveJohnston 1 (Coal Early Retirement/Conversions)	-	-	-	-	(106)	-	-	-	-	-	-	-	-	-	-	-	-	-	-	-	(106)	(106)
	DaveJohnston 2	-	-	-	-	-	-	-	-	-	-	-	-	-	(106)	-	-	-	-	-	-	-	(106)
	DaveJohnston 3	-	-	-	-	-	-	-	-	-	-	-	-	-	(220)	-	-	-	-	-	-	-	(220)
	DaveJohnston 4	-	-	-	-	-	-	-	-	-	-	-	-	-	-	-	-	-	(330)	-	-	-	(330)
	Naughton 1	-	-	-	-	-	-	-	-	-	-	-	-	-	-	-	(156)	-	-	-	-	-	(156)
	Naughton 2	-	-	-	-	-	-	-	-	-	-	-	-	-	-	-	(201)	-	-	-	-	-	(201)
	Naughton 3 (Coal Early Retirement/Conversions)	(50)	-	-	(280)	-	-	-	-	-	-	-	-	-	-	-	-	-	-	-	-	(330)	(330)
	Gadsby 1-6	-	-	-	-	-	-	-	-	-	-	-	-	-	-	-	-	-	-	(358)	-	-	(358)
	Coal Ret_AZ - Gas RePower	-	-	-	-	-	-	-	-	-	-	387	-	-	-	-	-	-	-	-	-	-	387
	Coal Ret_WY - Gas RePower	-	-	-	337	-	-	-	-	-	-	-	-	-	-	-	-	(337)	-	-	-	337	-
	Expansion Resources																						
	CCCT - DJohns - F 1xl	-	-	-	-	-	-	-	-	-	-	-	-	-	313	-	-	-	-	-	-	-	313
	CCCT - DJohns - J 1xl	-	-	-	-	-	-	-	-	-	-	-	-	-	-	-	-	-	-	423	-	-	423
	CCCT - Huntington - J 1xl	-	-	-	-	-	-	-	-	-	-	-	-	-	-	-	-	-	-	423	-	-	423
	CCCT - Naughton - J 1xl	-	-	-	-	-	-	-	-	-	-	-	-	-	-	-	-	-	401	-	-	-	401
	CCCT - Utah-N - F 2xl	-	-	-	-	-	-	-	-	-	-	-	-	-	-	-	-	-	-	-	635	-	635
	CCCT - Utah-S - J 1xl	-	-	-	-	-	-	-	-	-	-	-	-	-	-	-	-	423	-	-	423	-	846
	Total CCCT	-	-	-	-	-	-	-	-	-	-	-	-	-	313	-	423	-	401	1,269	635	-	3,041
	Wind, DJohnston, 43	-	-	-	-	-	25	-	-	-	-	-	-	-	-	-	-	-	-	-	-	25	25
	Total Wind	-	-	-	-	-	25	-	-	-	-	-	-	-	-	-	-	-	-	-	-	25	25
	Utility Solar - PV - East	-	-	-	-	-	154	-	-	-	-	-	-	-	-	-	-	-	-	-	-	154	154
	DSM, Class 2, ID	4	4	10	10	10	9	9	9	9	9	8	8	7	7	7	6	6	6	6	6	6	82
	DSM, Class 2, UT	69	78	115	112	122	109	112	122	124	123	105	119	121	121	118	105	104	102	102	101	1,083	2,180
	DSM, Class 2, WY	6	8	18	21	23	21	22	23	24	25	20	20	20	21	21	20	21	21	21	22	192	399
	DSM, Class 2 Total	79	90	142	142	155	138	143	154	157	157	132	147	148	149	146	132	130	130	129	128	1,357	2,728
	FOT Mona Q3	-	-	-	-	-	-	-	-	-	-	44	44	44	63	44	128	75	75	75	-	-	30
	Existing Plant Retirements/Conversions																						
JimBridger 1 (Coal Early Retirement/Conversions)	-	-	-	-	-	-	-	-	-	(354)	-	-	-	-	-	-	-	-	-	-	(354)	(354)	
JimBridger 2 (Coal Early Retirement/Conversions)	-	-	-	-	-	-	-	-	-	-	-	-	-	-	-	-	-	-	(359)	-	-	(359)	
Expansion Resources																							
Wind, YK, 29	-	-	-	-	-	-	-	-	-	-	-	-	-	-	-	-	-	144	-	-	-	144	
Total Wind	-	-	-	-	-	-	-	-	-	-	-	-	-	-	-	-	-	144	-	-	-	144	
Utility Solar - PV - West	-	-	-	-	-	332	-	-	-	-	-	-	-	-	-	-	-	-	-	-	332	332	
Oregon Solar Capacity Standard	-	-	7	-	-	-	-	-	-	-	-	-	-	-	-	-	-	-	-	-	7	7	
DSM, Class 1, OR-Curtail	-	-	-	-	-	-	-	-	-	-	10.6	-	10.6	-	-	-	-	-	-	-	10.6	31.8	
DSM, Class 1, OR-Irrigate	-	-	-	-	-	-	-	-	3.4	5.0	-	-	-	-	-	-	-	-	-	-	8.4	8.4	
DSM, Class 1 Total	-	-	-	-	-	-	-	-	3.4	5.0	-	-	10.6	-	-	-	-	10.6	-	-	19.0	40.2	
DSM, Class 2, CA	1	2	3	3	4	3	3	3	3	3	3	3	3	3	3	2	2	2	2	2	2	51	
DSM, Class 2, OR	44	39	60	58	51	48	45	44	41	39	37	37	37	37	35	33	33	33	30	30	469	809	
DSM, Class 2, WA	8	9	20	19	19	17	17	18	18	18	14	14	14	14	13	11	11	11	10	10	164	285	
DSM, Class 2 Total	54	49	83	80	74	68	65	64	63	61	54	53	53	53	50	46	45	45	42	42	661	1,145	
FOT COB Q3	-	93	100	19	136	-	-	-	-	185	186	169	188	268	112	268	268	44	92	-	53	106	
FOT MidColumbia Q3	400	400	400	400	400	400	400	400	400	400	400	400	400	400	400	400	400	400	400	400	400	400	
FOT MidColumbia Q3 - 2	227	375	375	375	375	335	78	375	316	375	375	375	375	375	375	375	375	375	375	233	321	341	
FOT NOB Q3	100	100	100	100	100	100	100	100	100	100	100	100	100	100	100	100	100	100	100	100	100	100	
Existing Plant Retirements/Conversions	(222)	-	-	57	(106)	-	-	(450)	-	(354)	-	-	-	(326)	-	(694)	(77)	-	(1,316)	-			
Annual Additions, Long Term Resources	132	146	226	221	229	718	208	221	225	229	185	210	201	516	196	745	186	576	1,440	805			
Annual Additions, Short Term Resources	727	968	975	894	1,011	835	578	875	816	1,060	1,105	1,088	1,107	1,206	1,031	1,271	1,218	994	1,042	733			
Total Annual Additions	859	1,115	1,200	1,116	1,240	1,553	786	1,096	1,041	1,289	1,290	1,299	1,308	1,721	1,228	2,016	1,404	1,570	2,482	1,538			

1/ Front office transaction amounts reflect one-year transaction periods, are not additive, and are reported as a 10/20-year annual average.

Case C04-1		Capacity (MW)																			Resource Totals 1/		
		2015	2016	2017	2018	2019	2020	2021	2022	2023	2024	2025	2026	2027	2028	2029	2030	2031	2032	2033	2034	10-year	20-year
East	Existing Plant Retirements/Conversions																						
	Hayden 1	-	-	-	-	-	-	-	-	-	-	-	-	-	-	-	-	(45)	-	-	-	-	(45)
	Hayden 2	-	-	-	-	-	-	-	-	-	-	-	-	-	-	-	-	(33)	-	-	-	-	(33)
	Hunter 2 (Coal Early Retirement/Conversions)	-	-	-	-	-	-	-	-	-	-	-	-	-	-	-	-	-	-	(269)	-	-	(269)
	Huntington 2 (Coal Early Retirement/Conversions)	-	-	-	-	-	-	-	(450)	-	-	-	-	-	-	-	-	-	-	-	-	(450)	(450)
	Carbon 1 (Coal Early Retirement/Conversions)	(67)	-	-	-	-	-	-	-	-	-	-	-	-	-	-	-	-	-	-	-	(67)	(67)
	Carbon 2 (Coal Early Retirement/Conversions)	(105)	-	-	-	-	-	-	-	-	-	-	-	-	-	-	-	-	-	-	-	(105)	(105)
	Cholla 4 (Coal Early Retirement/Conversions)	-	-	-	-	-	-	-	-	-	-	(387)	-	-	-	-	-	-	-	-	-	-	(387)
	DaveJohnston 1 (Coal Early Retirement/Conversions)	-	-	-	-	(106)	-	-	-	-	-	-	-	-	-	-	-	-	-	-	-	(106)	(106)
	DaveJohnston 2	-	-	-	-	-	-	-	-	-	-	-	-	-	(106)	-	-	-	-	-	-	-	(106)
	DaveJohnston 3	-	-	-	-	-	-	-	-	-	-	-	-	-	(220)	-	-	-	-	-	-	-	(220)
	DaveJohnston 4	-	-	-	-	-	-	-	-	-	-	-	-	-	-	-	-	-	(330)	-	-	-	(330)
	Naughton 1	-	-	-	-	-	-	-	-	-	-	-	-	-	-	-	(156)	-	-	-	-	-	(156)
	Naughton 2	-	-	-	-	-	-	-	-	-	-	-	-	-	-	-	(201)	-	-	-	-	-	(201)
	Naughton 3 (Coal Early Retirement/Conversions)	(50)	-	-	(280)	-	-	-	-	-	-	-	-	-	-	-	-	-	-	-	-	(330)	(330)
	Gadsby 1-6	-	-	-	-	-	-	-	-	-	-	-	-	-	-	-	-	-	(358)	-	-	-	(358)
	Coal Ret_AZ - Gas RePower	-	-	-	-	-	-	-	-	-	-	387	-	-	-	-	-	-	-	-	-	-	387
	Coal Ret_WY - Gas RePower	-	-	-	337	-	-	-	-	-	-	-	-	-	-	-	-	(337)	-	-	-	337	-
	Expansion Resources																						
	CCCT - DJohns - F 1xl	-	-	-	-	-	-	-	-	-	-	-	-	-	313	-	-	-	-	-	-	-	313
	CCCT - DJohns - J 1xl	-	-	-	-	-	-	-	-	-	-	-	-	-	-	-	-	-	423	-	-	-	423
	CCCT - Huntington - J 1xl	-	-	-	-	-	-	-	-	-	-	-	-	-	-	-	-	-	-	423	-	-	423
	CCCT - Naughton - J 1xl	-	-	-	-	-	-	-	-	-	-	-	-	-	-	-	-	-	401	-	-	-	401
	CCCT - Utah-N - F 2xl	-	-	-	-	-	-	-	-	-	-	-	-	-	-	-	-	-	-	-	635	-	635
	CCCT - Utah-S - J 1xl	-	-	-	-	-	-	-	-	-	-	-	-	-	-	-	423	-	-	423	-	-	846
	Total CCCT	-	-	-	-	-	-	-	-	-	-	-	-	-	313	-	423	-	401	1,269	635	-	3,041
	Wind, DJohnston, 43	-	-	-	-	-	25	-	-	-	-	-	-	-	-	-	-	-	-	-	-	25	25
	Wind, CO, 31	-	-	-	-	-	-	-	-	-	-	33	166	115	142	121	-	-	-	-	-	-	577
	Total Wind	-	-	-	-	-	25	-	-	-	-	33	166	115	142	121	-	-	-	-	-	25	602
	Utility Solar - PV - East	-	-	-	-	-	154	-	-	-	-	-	-	-	-	-	-	-	-	-	-	154	154
	DSM, Class 2, ID	4	4	10	10	10	9	9	9	9	9	7	8	7	7	7	6	6	6	6	6	82	149
	DSM, Class 2, UT	69	78	115	112	122	109	112	122	124	123	105	119	121	121	118	105	104	102	102	101	1,083	2,180
	DSM, Class 2, WY	6	8	18	21	23	21	22	23	24	25	20	20	20	21	21	20	21	21	21	22	192	399
	DSM, Class 2 Total	79	90	142	142	155	138	143	154	157	157	132	147	148	149	146	132	130	130	129	128	1,357	2,728
	FOT Mona Q3	-	-	-	-	-	-	-	-	-	-	-	-	-	-	14	-	44	33	-	-	-	5
West	Existing Plant Retirements/Conversions																						
	JimBridger 1 (Coal Early Retirement/Conversions)	-	-	-	-	-	-	-	-	-	(354)	-	-	-	-	-	-	-	-	-	(354)	(354)	
	JimBridger 2 (Coal Early Retirement/Conversions)	-	-	-	-	-	-	-	-	-	-	-	-	-	-	-	-	-	(359)	-	-	-	(359)
	Expansion Resources																						
	Wind, WW, 29	-	-	-	-	-	-	-	91	78	229	202	-	-	-	-	-	-	-	-	-	398	600
	Wind, YK, 29	-	-	-	-	-	-	334	66	-	-	-	-	-	-	-	-	-	-	-	-	400	400
	Total Wind	-	-	-	-	-	-	334	157	78	229	202	-	-	-	-	-	-	-	-	-	798	1,000
	Utility Solar - PV - West	-	-	-	-	-	405	-	-	-	-	-	-	-	-	-	-	-	-	-	-	405	405
	Oregon Solar Capacity Standard	-	7	-	-	-	-	-	-	-	-	-	-	-	-	-	-	-	-	-	-	7	7
	DSM, Class 1, OR-Curtail	-	-	-	-	-	-	-	-	10.6	-	-	10.6	-	-	-	10.6	-	-	-	-	10.6	31.8
	DSM, Class 1, OR-DLC-RES	-	-	-	-	-	-	-	-	-	3.7	-	-	-	-	-	-	-	-	-	-	3.7	3.7
	DSM, Class 1, OR-Irrigate	-	-	-	-	-	-	-	-	-	-	-	-	-	-	5.0	-	-	-	-	-	-	5.0
	DSM, Class 1 Total	-	-	-	-	-	-	-	-	10.6	-	3.7	-	10.6	-	5.0	-	10.6	-	-	-	14.4	40.5
	DSM, Class 2, CA	1	2	3	3	4	3	3	3	3	3	3	3	3	3	2	2	2	2	2	2	28	51
	DSM, Class 2, OR	44	39	60	58	51	48	45	44	41	39	37	37	37	37	35	33	33	33	30	30	469	809
	DSM, Class 2, WA	8	9	20	19	19	17	17	18	18	18	14	14	14	14	13	11	11	11	10	10	164	285
	DSM, Class 2 Total	54	49	83	80	74	68	65	64	63	61	54	53	53	53	51	46	45	45	42	42	661	1,145
	FOT COB Q3	-	93	100	19	136	-	-	-	-	-	-	-	-	-	-	42	-	-	-	-	35	20
	FOT MidColumbia Q3	400	400	400	400	400	400	373	400	400	400	400	400	400	400	400	400	400	400	323	397	397	395
	FOT MidColumbia Q3 - 2	227	375	375	375	310	-	225	152	348	340	301	303	369	187	375	375	184	232	-	-	276	271
	FOT NOB Q3	100	100	100	100	100	100	100	100	100	100	100	100	100	100	100	100	100	100	100	100	100	100
	Existing Plant Retirements/Conversions	(222)	-	-	57	(106)	-	-	(450)	-	(354)	-	-	-	(326)	-	(694)	(77)	-	(1,316)	-	-	-
	Annual Additions, Long Term Resources	132	146	226	222	229	791	542	386	298	451	420	376	316	658	322	601	186	576	1,440	805	-	-
Annual Additions, Short Term Resources	727	968	975	894	1,011	810	473	725	652	848	840	801	803	883	687	961	908	684	732	423	-	-	
Total Annual Additions	859	1,115	1,200	1,116	1,240	1,600	1,015	1,111	950	1,299	1,260	1,177	1,120	1,540	1,009	1,562	1,094	1,260	2,172	1,228	-	-	

1/ Front office transaction amounts reflect one-year transaction periods, are not additive, and are reported as a 10/20-year annual average.

Case C04-2		Capacity (MW)																			Resource Totals 1/		
		2015	2016	2017	2018	2019	2020	2021	2022	2023	2024	2025	2026	2027	2028	2029	2030	2031	2032	2033	2034	10-year	20-year
East	Existing Plant Retirements/Conversions																						
	Hayden 1	-	-	-	-	-	-	-	-	-	-	-	-	-	-	-	-	(45)	-	-	-	-	(45)
	Hayden 2	-	-	-	-	-	-	-	-	-	-	-	-	-	-	-	-	(33)	-	-	-	-	(33)
	Hunter 2 (Coal Early Retirement/Conversions)	-	-	-	-	-	-	-	-	-	-	(269)	-	-	-	-	-	-	-	-	-	-	(269)
	Huntington 1 (Coal Early Retirement/Conversions)	-	-	-	-	-	-	-	-	-	-	(459)	-	-	-	-	-	-	-	-	-	-	(459)
	Huntington 2 (Coal Early Retirement/Conversions)	-	-	-	-	-	-	-	(450)	-	-	-	-	-	-	-	-	-	-	-	-	(450)	(450)
	Carbon 1 (Coal Early Retirement/Conversions)	(67)	-	-	-	-	-	-	-	-	-	-	-	-	-	-	-	-	-	-	-	(67)	(67)
	Carbon 2 (Coal Early Retirement/Conversions)	(105)	-	-	-	-	-	-	-	-	-	-	-	-	-	-	-	-	-	-	-	(105)	(105)
	Cholla 4 (Coal Early Retirement/Conversions)	-	-	-	-	-	-	-	-	-	-	(387)	-	-	-	-	-	-	-	-	-	(387)	(387)
	DaveJohnston 1 (Coal Early Retirement/Conversions)	-	-	-	-	(106)	-	-	-	-	-	-	-	-	-	-	-	-	-	-	-	(106)	(106)
	DaveJohnston 2 (Coal Early Retirement/Conversions)	-	-	-	-	-	-	-	-	-	(106)	-	-	-	-	-	-	-	-	-	-	(106)	(106)
	DaveJohnston 3	-	-	-	-	-	-	-	-	-	-	-	-	-	(220)	-	-	-	-	-	-	(220)	(220)
	DaveJohnston 4	-	-	-	-	-	-	-	-	-	-	-	-	-	-	-	-	-	(330)	-	-	(330)	(330)
	Naughton 1	-	-	-	-	-	-	-	-	-	-	-	-	-	-	-	(156)	-	-	-	-	(156)	(156)
	Naughton 2	-	-	-	-	-	-	-	-	-	-	-	-	-	-	-	(201)	-	-	-	-	(201)	(201)
	Naughton 3 (Coal Early Retirement/Conversions)	(50)	-	-	(280)	-	-	-	-	-	-	-	-	-	-	-	-	-	-	-	-	(330)	(330)
	Wyodak (Coal Early Retirement/Conversions)	-	-	-	-	-	-	-	-	-	-	-	-	-	-	-	-	-	(268)	-	-	(268)	(268)
	Gadsby 1-6	-	-	-	-	-	-	-	-	-	-	-	-	-	-	-	-	-	(358)	-	-	(358)	(358)
	Coal Ret. AZ - Gas RePower	-	-	-	-	-	-	-	-	-	-	387	-	-	-	-	-	-	-	-	-	387	387
	Coal Ret. WY - Gas RePower	-	-	-	337	-	-	-	-	-	-	-	-	-	-	-	(337)	-	-	-	-	337	-
	Expansion Resources																						
	CCCT - DJohns - F 1x1	-	-	-	-	-	-	-	-	-	-	-	-	-	-	-	-	-	313	-	-	-	313
	CCCT - DJohns - J 1x1	-	-	-	-	-	-	-	-	-	-	-	-	-	-	-	-	-	423	-	-	-	423
	CCCT - Huntington - J 1x1	-	-	-	-	-	-	-	-	-	846	-	-	-	-	-	-	-	-	-	-	-	846
	CCCT - Naughton - J 1x1	-	-	-	-	-	-	-	-	-	-	-	-	-	-	-	401	-	-	-	-	-	401
	CCCT - Utah-N - F 2x1	-	-	-	-	-	-	-	-	-	-	-	-	-	-	-	-	-	635	-	-	-	635
	CCCT - Utah-S - J 1x1	-	-	-	-	-	-	-	-	-	-	-	-	-	423	-	423	-	-	-	-	-	846
	Total CCCT	-	-	-	-	-	-	-	-	-	846	-	-	423	-	824	-	-	1,371	-	-	-	3,464
	Wind, DJohnston, 43	-	-	-	-	-	25	-	-	-	-	-	-	-	-	-	-	-	-	-	-	25	25
	Wind, GO, 31	-	-	-	-	-	-	-	-	-	33	166	115	142	121	-	-	-	-	-	-	-	577
	Total Wind	-	-	-	-	25	-	-	-	-	33	166	115	142	121	-	-	-	-	-	-	25	602
	Utility Solar - PV - East	-	-	-	-	-	154	-	-	-	-	-	-	-	-	-	-	-	-	-	-	154	154
	DSM, Class 2, ID	4	4	10	10	10	9	9	9	9	9	8	7	7	7	7	6	6	6	6	6	6	82
	DSM, Class 2, UT	69	78	114	111	122	109	112	122	124	123	104	119	121	121	118	105	104	102	102	101	1,083	2,179
	DSM, Class 2, WY	6	8	18	20	23	21	22	23	24	25	20	20	20	21	21	20	21	21	21	22	192	399
	DSM, Class 2 Total	79	90	142	142	154	138	143	154	157	157	132	146	148	149	146	132	131	129	128	128	1,357	2,728
	FOT Mona Q3	-	-	-	-	-	-	-	-	-	-	8	-	-	-	9	-	-	6	-	-	-	1
	West	Existing Plant Retirements/Conversions																					
JimBridger 1 (Coal Early Retirement/Conversions)		-	-	-	-	-	-	-	-	-	(354)	-	-	-	-	-	-	-	-	-	(354)	(354)	
JimBridger 2 (Coal Early Retirement/Conversions)		-	-	-	-	-	-	-	-	-	-	-	-	-	-	(359)	-	-	-	-	(359)	(359)	
Expansion Resources																							
Wind, WW, 29		-	-	-	-	-	-	-	91	78	229	202	-	-	-	-	-	-	-	-	-	398	600
Wind, YK, 29		-	-	-	-	-	-	334	66	-	-	-	-	-	-	-	-	-	-	-	-	400	400
Total Wind		-	-	-	-	-	-	334	157	78	229	202	-	-	-	-	-	-	-	-	-	798	1,000
Utility Solar - PV - West		-	-	-	-	405	-	-	-	-	-	-	-	-	-	-	-	-	-	-	-	405	405
Oregon Solar Capacity Standard		-	7	-	-	-	-	-	-	-	-	-	-	-	-	-	-	-	-	-	-	7	7
DSM, Class 1, OR-Curtail		-	-	-	-	-	-	-	-	10.6	-	-	10.6	-	-	-	-	10.6	-	-	1.1	10.6	32.9
DSM, Class 1, OR-Irrigate		-	-	-	-	-	-	-	5.0	-	-	3.4	-	-	-	-	-	-	-	0.3	5.0	8.7	8.7
DSM, Class 1 Total		-	-	-	-	-	-	-	5.0	10.6	-	3.4	10.6	-	-	-	-	10.6	-	1.4	15.6	41.5	41.5
DSM, Class 2, CA		1	2	3	3	4	3	3	3	3	3	3	3	3	3	3	2	2	2	2	2	28	51
DSM, Class 2, OR		44	39	60	58	51	48	45	44	41	39	37	37	37	37	35	33	33	33	30	30	469	809
DSM, Class 2, WA		8	9	20	19	19	17	17	18	18	18	14	14	14	13	11	11	11	10	10	10	164	285
DSM, Class 2 Total		54	49	83	80	74	68	65	64	63	61	54	53	53	53	50	46	45	42	42	42	661	1,145
FOT COB Q3		-	93	100	19	137	-	-	-	-	72	-	-	-	-	-	-	-	-	-	-	42	21
FOT MidColumbia Q3		400	400	400	400	400	400	373	400	400	400	400	400	400	400	400	400	400	363	400	397	397	397
FOT MidColumbia Q3- 2		227	375	375	375	375	310	-	232	148	375	375	344	347	236	375	309	254	375	-	238	279	282
FOT NOB Q3		100	100	100	100	100	100	100	100	100	100	100	100	100	100	100	100	100	100	100	100	100	100
Existing Plant Retirements/Conversions		(222)	-	-	57	(106)	-	-	(450)	-	(460)	(728)	-	-	(220)	(359)	(694)	(77)	-	(956)	-	-	-
Annual Additions, Long Term Resources		133	146	225	221	228	791	542	380	308	447	1,270	376	316	767	317	1,001	187	175	1,543	172	-	-
Annual Additions, Short Term Resources		727	968	975	894	1,012	810	473	732	648	947	883	844	847	736	884	809	754	881	463	738	-	-
Total Annual Additions		859	1,115	1,200	1,116	1,240	1,601	1,015	1,111	956	1,395	2,152	1,220	1,163	1,504	1,201	1,810	941	1,056	2,006	910	-	-

1/ Front office transaction amounts reflect one-year transaction periods, are not additive, and are reported as a 10/20-year annual average.

Case C05-1		Capacity (MW)																				Resource Totals 1/				
		2015	2016	2017	2018	2019	2020	2021	2022	2023	2024	2025	2026	2027	2028	2029	2030	2031	2032	2033	2034	10-year	20-year			
East	Existing Plant Retirements/Conversions																									
	Hayden 1	-	-	-	-	-	-	-	-	-	-	-	-	-	-	-	-	-	(45)	-	-	-	-	(45)		
	Hayden 2	-	-	-	-	-	-	-	-	-	-	-	-	-	-	-	-	-	(33)	-	-	-	-	(33)		
	Hunter 2 (Coal Early Retirement/Conversions)	-	-	-	-	-	-	-	-	-	-	-	-	-	-	-	-	-	-	-	-	(269)	-	(269)		
	Huntington 2 (Coal Early Retirement/Conversions)	-	-	-	-	-	-	-	-	(450)	-	-	-	-	-	-	-	-	-	-	-	-	-	(450)	(450)	
	Carbon 1 (Coal Early Retirement/Conversions)	(67)	-	-	-	-	-	-	-	-	-	-	-	-	-	-	-	-	-	-	-	-	-	(67)	(67)	
	Carbon 2 (Coal Early Retirement/Conversions)	(105)	-	-	-	-	-	-	-	-	-	-	-	-	-	-	-	-	-	-	-	-	-	(105)	(105)	
	Cholla 4 (Coal Early Retirement/Conversions)	-	-	-	-	-	-	-	-	-	-	(387)	-	-	-	-	-	-	-	-	-	-	-	-	(387)	
	DaveJohnston 1 (Coal Early Retirement/Conversions)	-	-	-	-	(106)	-	-	-	-	-	-	-	-	-	-	-	-	-	-	-	-	-	(106)	(106)	
	DaveJohnston 2	-	-	-	-	-	-	-	-	-	-	-	-	-	(106)	-	-	-	-	-	-	-	-	-	(106)	
	DaveJohnston 3	-	-	-	-	-	-	-	-	-	-	-	-	-	(220)	-	-	-	-	-	-	-	-	-	(220)	
	DaveJohnston 4	-	-	-	-	-	-	-	-	-	-	-	-	-	-	-	-	-	-	-	(330)	-	-	-	(330)	
	Naughton 1	-	-	-	-	-	-	-	-	-	-	-	-	-	-	-	-	(156)	-	-	-	-	-	-	(156)	
	Naughton 2	-	-	-	-	-	-	-	-	-	-	-	-	-	-	-	(201)	-	-	-	-	-	-	-	(201)	
	Naughton 3 (Coal Early Retirement/Conversions)	(50)	-	-	(280)	-	-	-	-	-	-	-	-	-	-	-	-	-	-	-	-	-	(330)	-	(330)	
	Gadsby 1-6	-	-	-	-	-	-	-	-	-	-	-	-	-	-	-	-	-	-	-	-	(358)	-	-	(358)	
	Coal Ret. AZ - Gas RePower	-	-	-	-	-	-	-	-	-	-	-	387	-	-	-	-	-	-	-	-	-	-	-	387	
	Coal Ret. WY - Gas RePower	-	-	-	337	-	-	-	-	-	-	-	-	-	-	-	-	(337)	-	-	-	-	-	-	337	
	Expansion Resources																									
	CCCT - DJohns - F 1xl	-	-	-	-	-	-	-	-	-	-	-	-	-	-	313	-	-	-	-	-	-	-	-	313	
	CCCT - DJohns - J 1xl	-	-	-	-	-	-	-	-	-	-	-	-	-	-	-	-	-	-	-	423	-	-	-	423	
	CCCT - Huntington - J 1xl	-	-	-	-	-	-	-	-	-	-	-	-	-	-	423	-	-	-	-	-	-	-	-	423	
	CCCT - Naughton - J 1xl	-	-	-	-	-	-	-	-	-	-	-	-	-	-	-	-	-	-	401	-	-	-	-	401	
	CCCT - Utah-N - F 2xl	-	-	-	-	-	-	-	-	-	-	-	-	-	-	-	-	-	-	-	635	-	-	-	635	
	CCCT - Utah-N - J 1xl	-	-	-	-	-	-	-	-	-	-	-	-	-	-	-	-	-	-	-	423	-	-	-	423	
	CCCT - Utah-S - J 1xl	-	-	-	-	-	-	-	-	-	-	423	-	-	-	-	-	423	-	-	-	-	-	-	423	846
	Total CCCT	-	-	-	-	-	-	-	-	-	423	-	-	-	-	736	-	423	-	401	1,481	-	-	423	3,464	
	Wind, DJohnston, 43	-	-	-	-	-	25	-	-	-	-	-	-	-	-	-	-	-	-	-	-	-	-	25	25	
	Total Wind	-	-	-	-	-	25	-	-	-	-	-	-	-	-	-	-	-	-	-	-	-	-	25	25	
	Utility Solar - PV - East	-	-	-	-	-	154	-	-	-	-	-	-	-	-	-	-	-	-	-	-	-	-	154	154	
	DSM, Class 2, ID	4	4	5	5	5	4	4	4	5	5	4	4	5	5	5	4	4	4	4	4	4	4	44	86	
	DSM, Class 2, UT	69	78	84	86	92	81	84	88	89	90	73	73	72	72	70	66	65	63	64	64	840	840	1,522		
	DSM, Class 2, WY	6	8	10	12	14	12	13	14	15	16	13	13	13	14	14	14	14	15	15	15	121	121	260		
	DSM, Class 2 Total	79	90	99	102	111	97	101	106	108	111	90	90	90	90	88	84	84	84	82	83	1,004	1,004	1,869		
	FOT Mona Q3	-	-	-	-	11	-	-	-	125	110	35	118	156	229	44	44	214	203	75	63	291	28	86		
Existing Plant Retirements/Conversions																										
JimBridger 1 (Coal Early Retirement/Conversions)	-	-	-	-	-	-	-	-	-	(354)	-	-	-	-	-	-	-	-	-	-	-	-	(354)	(354)		
JimBridger 2 (Coal Early Retirement/Conversions)	-	-	-	-	-	-	-	-	-	-	-	-	-	-	-	-	-	-	-	(359)	-	-	-	(359)		
Expansion Resources																										
Wind, YK, 29	-	-	-	-	-	-	-	-	-	27	-	-	-	-	-	-	-	-	-	-	-	-	27	27		
Total Wind	-	-	-	-	-	-	-	-	-	27	-	-	-	-	-	-	-	-	-	-	-	-	27	27		
Oregon Solar Capacity Standard	-	7	-	-	-	-	-	-	-	-	-	-	-	-	-	-	-	-	-	-	-	7	7			
DSM, Class 1, OR-Curtail	-	-	-	-	-	-	-	-	-	10.6	-	-	10.6	-	-	-	10.6	-	-	-	1.1	10.6	32.9			
DSM, Class 1, OR-Irrigate	-	-	-	-	-	-	-	-	5.0	-	3.4	-	-	-	-	-	-	-	-	0.3	5.0	8.7				
DSM, Class 1 Total	-	-	-	-	-	-	-	-	5.0	10.6	3.4	10.6	-	-	-	-	10.6	-	-	1.4	15.6	41.5				
DSM, Class 2, CA	1	2	2	2	2	1	1	2	2	2	1	1	1	1	1	1	1	1	1	1	1	16	28			
DSM, Class 2, OR	44	39	35	32	29	28	25	25	23	23	21	21	21	21	20	20	20	20	19	19	303	503				
DSM, Class 2, WA	8	9	10	10	10	9	9	10	11	11	9	9	9	9	8	8	8	8	7	7	97	177				
DSM, Class 2 Total	54	49	47	44	42	38	36	36	36	35	31	31	30	30	29	29	29	29	27	27	416	709				
FOT COB Q3	-	93	149	114	268	261	-	268	268	268	268	268	268	238	118	268	268	216	102	191	169	195				
FOT MidColumbia Q3	400	400	400	400	400	400	400	400	400	400	400	400	400	400	400	400	400	400	400	400	400	400	400			
FOT MidColumbia Q3 - 2	227	375	375	375	375	375	314	375	375	375	375	375	375	375	375	375	375	375	375	375	375	354	365			
FOT NOB Q3	100	100	100	100	100	100	100	100	100	100	100	100	100	100	100	100	100	100	100	100	100	100	100			
Existing Plant Retirements/Conversions	(222)	-	-	57	(106)	-	-	(450)	-	(354)	-	-	-	(326)	-	(694)	(77)	-	(1,316)	-	-	-	-			
Annual Additions, Long Term Resources	132	146	146	146	152	314	137	147	155	596	124	131	121	857	117	536	123	513	1,590	111	-	-	-			
Annual Additions, Short Term Resources	727	968	1,024	989	1,153	1,136	814	1,268	1,252	1,178	1,261	1,299	1,372	1,157	1,037	1,356	1,346	1,166	1,040	1,357	-	-	-			
Total Annual Additions	859	1,115	1,170	1,135	1,306	1,450	951	1,415	1,407	1,773	1,385	1,430	1,493	2,014	1,155	1,893	1,469	1,679	2,630	1,468	-	-	-			

1/ Front office transaction amounts reflect one-year transaction periods, are not additive, and are reported as a 10/20-year annual average.

Case C05-2		Capacity (MW)																			Resource Totals 1/		
		2015	2016	2017	2018	2019	2020	2021	2022	2023	2024	2025	2026	2027	2028	2029	2030	2031	2032	2033	2034	10-year	20-year
East	Existing Plant Retirements/Conversions																						
	Hayden 1	-	-	-	-	-	-	-	-	-	-	-	-	-	-	-	-	(45)	-	-	-	-	(45)
	Hayden 2	-	-	-	-	-	-	-	-	-	-	-	-	-	-	-	-	(33)	-	-	-	-	(33)
	Hunter 2 (Coal Early Retirement/Conversions)	-	-	-	-	-	-	-	-	-	-	(269)	-	-	-	-	-	-	-	-	-	-	(269)
	Huntington 1 (Coal Early Retirement/Conversions)	-	-	-	-	-	-	-	-	-	-	(459)	-	-	-	-	-	-	-	-	-	-	(459)
	Huntington 2 (Coal Early Retirement/Conversions)	-	-	-	-	-	-	-	(450)	-	-	-	-	-	-	-	-	-	-	-	-	(450)	(450)
	Carbon 1 (Coal Early Retirement/Conversions)	(67)	-	-	-	-	-	-	-	-	-	-	-	-	-	-	-	-	-	-	-	(67)	(67)
	Carbon 2 (Coal Early Retirement/Conversions)	(105)	-	-	-	-	-	-	-	-	-	-	-	-	-	-	-	-	-	-	-	(105)	(105)
	Cholla 4 (Coal Early Retirement/Conversions)	-	-	-	-	-	-	-	-	-	-	(387)	-	-	-	-	-	-	-	-	-	(387)	(387)
	DaveJohnston 1 (Coal Early Retirement/Conversions)	-	-	-	-	(106)	-	-	-	-	-	-	-	-	-	-	-	-	-	-	-	(106)	(106)
	DaveJohnston 2 (Coal Early Retirement/Conversions)	-	-	-	-	-	-	-	-	-	(106)	-	-	-	-	-	-	-	-	-	-	(106)	(106)
	DaveJohnston 3	-	-	-	-	-	-	-	-	-	-	-	-	-	(220)	-	-	-	-	-	-	(220)	(220)
	DaveJohnston 4	-	-	-	-	-	-	-	-	-	-	-	-	-	-	-	-	-	-	(330)	-	(330)	(330)
	Naughton 1	-	-	-	-	-	-	-	-	-	-	-	-	-	-	-	(156)	-	-	-	-	(156)	(156)
	Naughton 2	-	-	-	-	-	-	-	-	-	-	-	-	-	-	-	(201)	-	-	-	-	(201)	(201)
	Naughton 3 (Coal Early Retirement/Conversions)	(50)	-	-	(280)	-	-	-	-	-	-	-	-	-	-	-	-	-	-	-	-	(330)	(330)
	Wyodak (Coal Early Retirement/Conversions)	-	-	-	-	-	-	-	-	-	-	-	-	-	-	-	-	-	-	(268)	-	(268)	(268)
	Cadby 1-6	-	-	-	-	-	-	-	-	-	-	-	-	-	-	-	-	-	-	(358)	-	(358)	(358)
	Coal Ret_AZ - Gas RePower	-	-	-	-	-	-	-	-	-	-	387	-	-	-	-	-	-	-	-	-	-	387
	Coal Ret_WY - Gas RePower	-	-	-	337	-	-	-	-	-	-	-	-	-	-	-	(337)	-	-	-	-	337	-
	Expansion Resources																						
	CCCT - DJohns - F 2x1	-	-	-	-	-	-	-	-	-	-	-	-	-	-	-	-	-	-	635	-	-	635
	CCCT - Huntington - J 1x1	-	-	-	-	-	-	-	-	-	-	846	-	-	-	-	-	-	-	-	-	-	846
	CCCT - Naughton - J 1x1	-	-	-	-	-	-	-	-	-	-	-	-	-	-	-	-	401	-	-	-	-	401
	CCCT - Utah-N - F 2x1	-	-	-	-	-	-	-	-	-	-	-	-	-	-	635	-	-	-	635	-	-	1,270
	CCCT - Utah-S - J 1x1	-	-	-	-	-	-	-	-	-	423	-	-	423	-	-	-	-	-	-	-	423	846
	Total CCCT	-	-	-	-	-	-	-	-	-	423	846	-	423	-	635	401	-	-	1,270	-	423	3,998
	Wind_DJohnston_43	-	-	-	-	-	106	-	-	-	12	-	-	-	9	-	-	-	-	-	-	118	127
	Total Wind	-	-	-	-	-	106	-	-	-	12	-	-	-	9	-	-	-	-	-	-	118	127
	Utility Solar - PV - East	-	-	-	-	-	-	-	-	58	-	-	-	-	-	-	-	-	36	-	-	58	94
	DSM, Class 1, ID-Irrigate	-	-	-	-	-	-	-	-	-	-	-	-	-	-	-	-	-	4.0	-	-	-	4.0
	DSM, Class 1, UT-DLC-RES	-	-	-	-	-	-	-	-	-	-	-	-	-	-	-	-	-	4.9	-	-	-	4.9
	DSM, Class 1 Total	-	-	-	-	-	-	-	-	-	-	-	-	-	-	-	-	-	9.0	-	-	-	9.0
	DSM, Class 2, ID	4	4	5	5	5	4	4	4	5	5	5	5	5	5	5	4	4	5	4	4	45	91
	DSM, Class 2, UT	69	78	84	86	92	81	84	90	91	97	78	81	83	84	81	75	75	75	69	71	851	1,622
	DSM, Class 2, WY	6	8	10	12	14	12	13	14	15	16	13	13	14	15	15	16	16	17	17	17	121	272
	DSM, Class 2 Total	79	90	99	102	111	97	102	108	110	118	96	99	101	104	101	95	95	96	90	92	1,017	1,985
	FOT Mona Q3	-	-	-	-	10	37	-	168	129	154	180	210	44	227	-	177	157	294	81	300	50	108
West	Existing Plant Retirements/Conversions																						
	JimBridger 1 (Coal Early Retirement/Conversions)	-	-	-	-	-	-	-	-	-	(354)	-	-	-	-	-	-	-	-	-	-	(354)	(354)
	JimBridger 2 (Coal Early Retirement/Conversions)	-	-	-	-	-	-	-	-	-	-	-	-	-	-	(359)	-	-	-	-	-	(359)	(359)
	Expansion Resources																						
	Oregon Solar Capacity Standard	-	7	-	-	-	-	-	-	-	-	-	-	-	-	-	-	-	-	-	-	7	7
	DSM, Class 1, OR-Curtail	-	-	-	-	-	-	-	-	10.6	-	-	10.6	-	-	-	-	10.6	-	-	-	10.6	31.8
	DSM, Class 1, OR-Irrigate	-	-	-	-	-	-	-	5.0	-	-	3.4	-	-	-	-	-	-	-	-	-	5.0	8.4
	DSM, Class 1 Total	-	-	-	-	-	-	-	5.0	10.6	-	3.4	10.6	-	-	-	-	10.6	-	-	-	15.6	40.2
	DSM, Class 2, CA	1	2	2	2	2	1	1	2	2	2	1	1	1	1	1	1	1	1	1	1	16	30
	DSM, Class 2, OR	44	39	35	32	29	28	25	25	23	23	22	22	22	22	21	21	21	20	20	303	514	
	DSM, Class 2, WA	8	9	10	10	11	9	10	10	11	11	9	9	9	9	8	8	8	8	7	7	98	181
	DSM, Class 2 Total	54	49	47	44	42	38	36	36	36	35	32	32	32	32	30	30	30	28	28	417	724	
	FOT COB Q3	-	93	149	113	268	268	-	268	268	268	268	268	128	268	116	268	268	268	163	255	169	198
	FOT MidColumbia Q3	400	400	400	400	400	400	400	400	400	400	400	400	400	400	400	400	400	400	400	400	400	400
	FOT MidColumbia Q3 - 2	227	375	375	375	375	375	358	375	375	375	375	375	375	375	375	375	375	375	375	375	358	367
	FOT NOB Q3	100	100	100	100	100	100	100	100	100	100	100	100	100	100	100	100	100	100	100	100	100	100
	Existing Plant Retirements/Conversions	(222)	-	-	57	(106)	-	-	(450)	-	(460)	(728)	-	-	(220)	(359)	(694)	(77)	-	(956)	-	-	-
	Annual Additions, Long Term Resources	133	146	146	146	153	241	138	149	215	588	977	141	556	145	768	526	136	171	1,388	120	-	-
	Annual Additions, Short Term Resources	727	968	1,024	988	1,153	1,180	858	1,311	1,272	1,297	1,322	1,353	1,047	1,370	991	1,320	1,300	1,437	1,119	1,430	-	-
	Total Annual Additions	859	1,114	1,170	1,135	1,305	1,422	996	1,460	1,487	1,885	2,299	1,494	1,603	1,514	1,759	1,846	1,436	1,608	2,507	1,550	-	-

1/ Front office transaction amounts reflect one-year transaction periods, are not additive, and are reported as a 10/20-year annual average.

Case C05b-1		Capacity (MW)																			Resource Totals 1/					
		2015	2016	2017	2018	2019	2020	2021	2022	2023	2024	2025	2026	2027	2028	2029	2030	2031	2032	2033	2034	10-year	20-year			
East	Existing Plant Retirements/Conversions																									
	Hayden 1	-	-	-	-	-	-	-	-	-	-	-	-	-	-	-	-	-	(45)	-	-	-	-	(45)		
	Hayden 2	-	-	-	-	-	-	-	-	-	-	-	-	-	-	-	-	-	(33)	-	-	-	-	(33)		
	Hunter 2 (Coal Early Retirement/Conversions)	-	-	-	-	-	-	-	-	-	-	-	-	-	-	-	-	-	-	-	(269)	-	-	(269)		
	Huntington 2 (Coal Early Retirement/Conversions)	-	-	-	-	-	-	-	(450)	-	-	-	-	-	-	-	-	-	-	-	-	-	-	(450)	(450)	
	Carbon 1 (Coal Early Retirement/Conversions)	(67)	-	-	-	-	-	-	-	-	-	-	-	-	-	-	-	-	-	-	-	-	-	(67)	(67)	
	Carbon 2 (Coal Early Retirement/Conversions)	(105)	-	-	-	-	-	-	-	-	-	-	-	-	-	-	-	-	-	-	-	-	-	(105)	(105)	
	Cholla 4 (Coal Early Retirement/Conversions)	-	-	-	-	-	-	-	-	-	-	(387)	-	-	-	-	-	-	-	-	-	-	-	-	(387)	
	DaveJohnston 1 (Coal Early Retirement/Conversions)	-	-	-	-	(106)	-	-	-	-	-	-	-	-	-	-	-	-	-	-	-	-	-	(106)	(106)	
	DaveJohnston 2	-	-	-	-	-	-	-	-	-	-	-	-	-	(106)	-	-	-	-	-	-	-	-	-	(106)	
	DaveJohnston 3	-	-	-	-	-	-	-	-	-	-	-	-	-	(220)	-	-	-	-	-	-	-	-	-	(220)	
	DaveJohnston 4	-	-	-	-	-	-	-	-	-	-	-	-	-	-	-	-	-	-	-	(330)	-	-	-	(330)	
	Naughton 1	-	-	-	-	-	-	-	-	-	-	-	-	-	-	-	(156)	-	-	-	-	-	-	-	(156)	
	Naughton 2	-	-	-	-	-	-	-	-	-	-	-	-	-	-	-	(201)	-	-	-	-	-	-	-	(201)	
	Naughton 3 (Coal Early Retirement/Conversions)	(50)	-	-	(280)	-	-	-	-	-	-	-	-	-	-	-	-	-	-	-	-	-	-	(330)	(330)	
	Gadsby 1-6	-	-	-	-	-	-	-	-	-	-	-	-	-	-	-	-	-	-	-	(358)	-	-	-	(358)	
	Coal Ret_AZ - Gas RePower	-	-	-	-	-	-	-	-	-	-	387	-	-	-	-	-	-	-	-	-	-	-	-	387	
	Coal Ret_WY - Gas RePower	-	-	-	337	-	-	-	-	-	-	-	-	-	-	-	-	(337)	-	-	-	-	-	-	337	-
	Expansion Resources																									
	CCCT - DJohns - F 1x1	-	-	-	-	-	-	-	-	-	-	-	-	-	-	313	-	-	-	-	-	-	-	-	313	
	CCCT - DJohns - J 1x1	-	-	-	-	-	-	-	-	-	-	-	-	-	-	-	-	-	-	-	423	-	-	-	423	
	CCCT - Huntington - J 1x1	-	-	-	-	-	-	-	-	-	-	-	-	-	423	-	-	-	-	-	-	-	-	-	423	
	CCCT - Naughton - J 1x1	-	-	-	-	-	-	-	-	-	-	-	-	-	-	-	-	-	401	-	-	-	-	-	401	
	CCCT - Utah-N - F 2x1	-	-	-	-	-	-	-	-	-	-	-	-	-	-	-	-	-	-	-	-	-	635	-	635	
	CCCT - Utah-N - J 1x1	-	-	-	-	-	-	-	-	-	-	-	-	-	-	-	-	-	-	-	-	423	-	-	423	
	CCCT - Utah-S - J 1x1	-	-	-	-	-	-	-	-	-	423	-	-	-	-	-	-	423	-	-	-	-	-	-	423	846
	Total CCCT	-	-	-	-	-	-	-	-	-	423	-	-	-	-	-	736	-	-	401	1,481	-	-	423	3,464	
	Wind, DJohns, 43	-	-	-	-	-	-	-	-	-	-	-	-	-	13	-	-	-	-	-	-	-	-	-	13	
	Wind, WYAE, 43	-	-	-	-	-	-	-	-	-	-	-	-	-	12	-	-	-	-	-	-	-	-	-	12	
	Total Wind	-	-	-	-	-	-	-	-	-	-	-	-	-	25	-	-	-	-	-	-	-	-	-	25	
	Utility Solar - PV - East	-	-	-	-	-	-	-	-	-	-	-	-	-	154	-	-	-	-	-	-	-	-	-	154	
	DSM, Class 2, ID	4	4	5	5	5	4	4	4	5	5	4	4	5	5	4	4	4	4	4	4	4	4	44	86	
	DSM, Class 2, UT	69	78	84	86	92	81	84	88	89	90	73	73	72	72	70	66	65	65	63	64	64	840	1,522		
	DSM, Class 2, WY	6	8	10	12	14	12	13	14	15	16	13	13	13	14	14	14	15	15	15	15	15	121	260		
	DSM, Class 2 Total	79	90	99	102	111	97	101	106	108	111	90	90	90	90	88	84	84	84	82	83	1,005	1,869			
	FOT Mona Q3	-	-	-	-	10	53	-	185	169	101	184	222	295	44	44	146	135	75	44	225	-	52	97		
	Existing Plant Retirements/Conversions																									
	JimBridger 1 (Coal Early Retirement/Conversions)	-	-	-	-	-	-	-	-	-	-	(354)	-	-	-	-	-	-	-	-	-	-	-	(354)	(354)	
	JimBridger 2 (Coal Early Retirement/Conversions)	-	-	-	-	-	-	-	-	-	-	-	-	-	-	-	-	-	-	-	(359)	-	-	-	(359)	
	Expansion Resources																									
Wind, YK, 29	-	-	-	-	-	-	-	-	-	-	-	-	-	-	277	-	-	-	-	-	-	-	-	277		
Total Wind	-	-	-	-	-	-	-	-	-	-	-	-	-	-	277	-	-	-	-	-	-	-	-	277		
Oregon Solar Capacity Standard	-	7	-	-	-	-	-	-	-	-	-	-	-	-	-	-	-	-	-	-	-	-	7	7		
DSM, Class 1, OR-Curtail	-	-	-	-	-	-	-	-	10.6	-	-	-	10.6	-	-	-	-	-	-	10.6	-	-	-	10.6	31.8	
DSM, Class 1, OR-Irrigate	-	-	-	-	-	-	-	-	5.0	-	-	3.4	-	-	-	-	-	-	-	-	-	-	-	5.0	8.4	
DSM, Class 1 Total	-	-	-	-	-	-	-	-	5.0	10.6	-	3.4	10.6	-	-	-	-	-	10.6	-	-	-	-	15.6	40.2	
DSM, Class 2, CA	1	2	2	2	2	1	1	2	2	2	1	1	1	1	1	1	1	1	1	1	1	1	16	28		
DSM, Class 2, OR	44	39	36	33	29	27	25	23	23	21	21	21	21	20	20	20	20	19	19	19	303	503				
DSM, Class 2, WA	8	9	10	10	10	9	9	10	11	11	9	9	9	9	8	8	8	8	7	7	7	97	177			
DSM, Class 2 Total	54	49	47	44	42	38	36	36	36	35	31	31	31	30	29	29	29	29	27	27	415	709				
FOT COB Q3	-	93	149	114	268	268	-	268	268	268	268	268	268	170	50	268	268	148	53	191	170	182				
FOT MidColumbia Q3	400	400	400	400	400	400	400	400	400	400	400	400	400	400	400	400	400	400	400	400	400	400	400	400		
FOT MidColumbia Q3 - 2	227	375	375	375	375	375	374	375	375	375	375	375	375	375	375	375	375	375	375	375	375	375	360	368		
FOT NOB Q3	100	100	100	100	100	100	100	100	100	100	100	100	100	100	100	100	100	100	100	100	100	100	100	100		
Existing Plant Retirements/Conversions	(222)	-	-	57	(106)	-	-	(450)	-	-	(354)	-	-	-	-	(694)	(77)	-	(1,316)	-	-	-	-	-		
Annual Additions, Long Term Resources	133	146	146	146	152	135	137	147	155	569	124	131	121	1,313	117	536	123	513	1,590	110	-	-	-	110		
Annual Additions, Short Term Resources	727	968	1,024	989	1,153	1,196	874	1,328	1,312	1,244	1,327	1,365	1,438	1,089	969	1,289	1,278	1,098	972	1,291	-	-	-	-		
Total Annual Additions	860	1,114	1,170	1,135	1,305	1,330	1,011	1,475	1,467	1,813	1,451	1,496	1,559	2,402	1,086	1,825	1,402	1,611	2,562	1,401	-	-	-	-		

1/ Front office transaction amounts reflect one-year transaction periods, are not additive, and are reported as a 10-20-year annual average.

Case C05a-2		Capacity (MW)																			Resource Totals 1/		
		2015	2016	2017	2018	2019	2020	2021	2022	2023	2024	2025	2026	2027	2028	2029	2030	2031	2032	2033	2034	10-year	20-year
East	Existing Plant Retirements/Conversions																						
	Hayden 1	-	-	-	-	-	-	-	-	-	-	-	-	-	-	-	-	(45)	-	-	-	-	(45)
	Hayden 2	-	-	-	-	-	-	-	-	-	-	-	-	-	-	-	-	(33)	-	-	-	-	(33)
	Hunter 2 (Coal Early Retirement/Conversions)	-	-	-	-	-	-	-	-	-	-	(269)	-	-	-	-	-	-	-	-	-	-	(269)
	Huntington 1 (Coal Early Retirement/Conversions)	-	-	-	-	-	-	-	-	-	-	(459)	-	-	-	-	-	-	-	-	-	-	(459)
	Huntington 2 (Coal Early Retirement/Conversions)	-	-	-	-	-	-	-	(450)	-	-	-	-	-	-	-	-	-	-	-	-	(450)	(450)
	Carbon 1 (Coal Early Retirement/Conversions)	(67)	-	-	-	-	-	-	-	-	-	-	-	-	-	-	-	-	-	-	-	(67)	(67)
	Carbon 2 (Coal Early Retirement/Conversions)	(105)	-	-	-	-	-	-	-	-	-	-	-	-	-	-	-	-	-	-	-	(105)	(105)
	Cholla 4 (Coal Early Retirement/Conversions)	-	-	-	-	-	-	-	-	-	-	(387)	-	-	-	-	-	-	-	-	-	(387)	(387)
	DaveJohnston 1 (Coal Early Retirement/Conversions)	-	-	-	-	(106)	-	-	-	-	-	-	-	-	-	-	-	-	-	-	-	(106)	(106)
	DaveJohnston 2 (Coal Early Retirement/Conversions)	-	-	-	-	-	-	-	-	-	(106)	-	-	-	-	-	-	-	-	-	-	(106)	(106)
	DaveJohnston 3	-	-	-	-	-	-	-	-	-	-	-	-	-	(220)	-	-	-	-	-	-	(220)	(220)
	DaveJohnston 4	-	-	-	-	-	-	-	-	-	-	-	-	-	-	-	-	-	(330)	-	-	(330)	(330)
	Naughton 1	-	-	-	-	-	-	-	-	-	-	-	-	-	-	-	(156)	-	-	-	-	(156)	(156)
	Naughton 2	-	-	-	-	-	-	-	-	-	-	-	-	-	-	-	(201)	-	-	-	-	(201)	(201)
	Naughton 3 (Coal Early Retirement/Conversions)	(50)	-	-	(280)	-	-	-	-	-	-	-	-	-	-	-	-	-	-	-	-	(330)	(330)
	Wyodak (Coal Early Retirement/Conversions)	-	-	-	-	-	-	-	-	-	-	-	-	-	-	-	-	-	-	(268)	-	(268)	(268)
	Cadsby 1-6	-	-	-	-	-	-	-	-	-	-	-	-	-	-	-	-	-	-	(358)	-	(358)	(358)
	Coal Ret_AZ - Gas RePower	-	-	-	-	-	-	-	-	-	-	387	-	-	-	-	-	-	-	-	-	387	387
	Coal Ret_WY - Gas RePower	-	-	-	337	-	-	-	-	-	-	-	-	-	-	-	-	(337)	-	-	-	337	-
	Expansion Resources																						
	CCCT - DJohns - F 2x1	-	-	-	-	-	-	-	-	-	-	-	-	-	-	-	-	-	-	635	-	-	635
	CCCT - Huntington - J 1x1	-	-	-	-	-	-	-	-	-	-	846	-	-	-	-	-	-	-	-	-	-	846
	CCCT - Naughton - J 1x1	-	-	-	-	-	-	-	-	-	-	-	-	-	-	-	401	-	-	-	-	-	401
	CCCT - Utah-N - F 2x1	-	-	-	-	-	-	-	-	-	-	-	-	-	-	635	-	-	-	635	-	-	1,270
	CCCT - Utah-S - J 1x1	-	-	-	-	-	-	-	-	-	423	-	-	423	-	-	-	-	-	-	-	-	846
	Total CCCT	-	-	-	-	-	-	-	-	-	423	846	-	423	-	635	401	-	-	1,270	-	423	3,998
	Wind, DJohnston, 43	-	-	-	-	-	-	-	-	-	-	-	-	-	9	-	-	-	-	-	-	-	9
	Total Wind	-	-	-	-	-	-	-	-	-	-	-	-	-	9	-	-	-	-	-	-	-	9
	Utility Solar - PV - East	-	-	-	-	-	-	-	-	-	-	-	-	-	-	-	-	-	62	-	-	-	62
	DSM, Class 1, ID-Irrigate	-	-	-	-	-	-	-	-	-	-	-	-	-	-	-	-	-	11.2	-	-	-	11.2
	DSM, Class 1, UT-DLC-RES	-	-	-	-	-	-	-	-	-	-	-	-	-	-	-	-	-	4.9	-	-	-	4.9
	DSM, Class 1, UT-Irrigate	-	-	-	-	-	-	-	-	-	-	-	-	-	-	-	-	-	10.0	-	-	-	10.0
	DSM, Class 1, WY-Curtail	-	-	-	-	-	-	-	-	-	-	-	-	-	-	-	-	-	3.1	-	-	-	3.1
	DSM, Class 1 Total	-	-	-	-	-	-	-	-	-	-	-	-	-	-	-	-	-	3.1	26.1	-	-	29.1
	DSM, Class 2, ID	4	4	5	5	5	4	4	4	5	6	5	5	5	5	5	4	4	5	4	4	45	91
	DSM, Class 2, UT	69	78	84	86	92	81	86	90	91	93	78	81	84	84	81	75	76	74	69	69	849	1,620
	DSM, Class 2, WY	7	8	10	12	14	12	13	14	15	16	13	13	14	15	15	16	16	16	16	16	122	272
	DSM, Class 2 Total	79	90	99	102	111	97	103	108	110	115	96	99	103	104	101	95	96	95	89	89	1,015	1,983
	FOT Mona Q3	-	-	-	-	9	52	-	181	163	192	218	248	44	263	21	214	190	300	75	300	60	124
	Existing Plant Retirements/Conversions																						
	JimBridger 1 (Coal Early Retirement/Conversions)	-	-	-	-	-	-	-	-	-	(354)	-	-	-	-	-	-	-	-	-	-	(354)	(354)
	JimBridger 2 (Coal Early Retirement/Conversions)	-	-	-	-	-	-	-	-	-	-	-	-	-	-	(359)	-	-	-	-	-	(359)	(359)
	Expansion Resources																						
	Oregon Solar Capacity Standard	-	7	-	-	-	-	-	-	-	-	-	-	-	-	-	-	-	-	-	-	7	7
DSM, Class 1, OR-Curtail	-	-	-	-	-	-	-	-	10.6	-	-	10.6	-	-	-	-	-	10.6	-	-	10.6	31.8	
DSM, Class 1, OR-Irrigate	-	-	-	-	-	-	-	5.0	-	-	3.4	-	-	-	-	-	-	-	-	-	5.0	8.4	
DSM, Class 1 Total	-	-	-	-	-	-	-	5.0	10.6	-	3.4	10.6	-	-	-	-	-	10.6	-	-	15.6	40.2	
DSM, Class 2, CA	1	2	2	2	2	1	1	2	2	2	1	1	1	1	1	1	1	1	1	1	16	30	
DSM, Class 2, OR	44	39	36	32	29	27	25	25	23	24	22	22	22	22	21	21	21	20	19	304	515		
DSM, Class 2, WA	8	9	10	10	11	9	10	10	11	11	9	9	9	9	8	8	8	8	7	98	181		
DSM, Class 2 Total	54	49	47	44	42	38	36	36	36	36	32	32	32	32	30	30	30	28	28	418	725		
FOT COB Q3	-	93	148	113	268	268	-	268	268	268	268	268	165	268	131	268	268	175	263	169	202		
FOT MidColumbia Q3	400	400	400	400	400	400	400	400	400	400	400	400	400	400	400	400	400	400	400	400	400		
FOT MidColumbia Q3-2	227	375	375	375	375	375	375	375	375	375	375	375	375	375	375	375	375	375	375	360	367		
FOT NOB Q3	100	100	100	100	100	100	100	100	100	100	100	100	100	100	100	100	100	100	100	100	100		
Existing Plant Retirements/Conversions	(222)	-	-	57	(106)	-	-	(450)	-	(460)	(728)	-	-	(220)	(359)	(694)	(77)	-	(956)	-	-		
Annual Additions, Long Term Resources	133	147	146	146	153	135	139	149	157	174	141	158	145	145	140	140	140	140	140	1,387	1,117		
Annual Additions, Short Term Resources	727	968	1,023	988	1,152	1,195	871	1,324	1,306	1,335	1,361	1,391	1,084	1,406	1,027	1,357	1,333	1,443	1,125	1,438	1,438		
Total Annual Additions	860	1,114	1,169	1,134	1,305	1,329	1,010	1,473	1,463	1,909	2,338	1,533	1,642	1,551	1,796	1,883	1,473	1,657	2,512	1,555	1,555		

1/ Front office transaction amounts reflect one-year transaction periods, are not additive, and are reported as a 10-20 year annual average.

Case C05-3		Capacity (MW)																				Resource Totals 1/		
		2015	2016	2017	2018	2019	2020	2021	2022	2023	2024	2025	2026	2027	2028	2029	2030	2031	2032	2033	2034	10-year	20-year	
East	Existing Plant Retirements/Conversions																							
	Hayden 1	-	-	-	-	-	-	-	-	-	-	-	-	-	-	-	-	-	(45)	-	-	-	-	(45)
	Hayden 2	-	-	-	-	-	-	-	-	-	-	-	-	-	-	-	-	-	(33)	-	-	-	-	(33)
	Hunter 2 (Coal Early Retirement/Conversions)	-	-	-	-	-	-	-	-	-	-	-	-	-	-	-	-	-	-	-	(269)	-	-	(269)
	Huntington 2 (Coal Early Retirement/Conversions)	-	-	-	-	-	-	-	-	-	-	-	-	-	-	-	-	-	(450)	-	-	-	-	(450)
	Carbon 1 (Coal Early Retirement/Conversions)	(67)	-	-	-	-	-	-	-	-	-	-	-	-	-	-	-	-	-	-	-	-	(67)	(67)
	Carbon 2 (Coal Early Retirement/Conversions)	(105)	-	-	-	-	-	-	-	-	-	-	-	-	-	-	-	-	-	-	-	-	(105)	(105)
	Cholla 4 (Coal Early Retirement/Conversions)	-	-	-	-	-	-	-	-	-	-	(387)	-	-	-	-	-	-	-	-	-	-	-	(387)
	DaveJohnston 1	-	-	-	-	-	-	-	-	-	-	-	-	-	(106)	-	-	-	-	-	-	-	-	(106)
	DaveJohnston 2	-	-	-	-	-	-	-	-	-	-	-	-	-	(106)	-	-	-	-	-	-	-	-	(106)
	DaveJohnston 3	-	-	-	-	-	-	-	-	-	-	-	-	-	(220)	-	-	-	-	-	-	-	-	(220)
	DaveJohnston 4	-	-	-	-	-	-	-	-	-	-	-	-	-	(330)	-	-	-	-	-	-	-	-	(330)
	Naughton 1	-	-	-	-	-	-	-	-	-	-	-	-	-	-	-	(156)	-	-	-	-	-	-	(156)
	Naughton 2	-	-	-	-	-	-	-	-	-	-	-	-	-	-	-	(201)	-	-	-	-	-	-	(201)
	Naughton 3 (Coal Early Retirement/Conversions)	(50)	-	-	(280)	-	-	-	-	-	-	-	-	-	-	-	-	-	-	-	-	-	(330)	(330)
	Cadsby 1-6	-	-	-	-	-	-	-	-	-	-	-	-	-	-	-	-	-	-	-	(358)	-	-	(358)
	Coal Ret_AZ - Gas RePower	-	-	-	-	-	-	-	-	-	-	387	-	-	-	-	-	-	-	-	-	-	-	387
	Coal Ret_WY - Gas RePower	-	-	-	337	-	-	-	-	-	-	-	-	-	-	-	-	(337)	-	-	-	-	337	-
	Expansion Resources																							
	CCCT - DJohns - F 1x1	-	-	-	-	-	-	-	-	-	-	-	-	-	-	-	313	-	-	-	-	-	-	313
	CCCT - DJohns - J 1x1	-	-	-	-	-	-	-	-	-	-	-	-	-	423	-	-	-	-	-	-	-	-	423
	CCCT - Utah-N - F 2x1	-	-	-	-	-	-	-	-	-	-	-	-	-	-	-	-	-	-	-	635	-	-	635
	CCCT - Utah-S - J 1x1	-	-	-	-	-	-	-	-	-	-	-	-	-	-	-	846	-	-	-	-	-	-	846
	Total CCCT	-	-	-	-	-	-	-	-	-	-	-	-	-	423	-	1,159	-	-	635	-	-	-	2,217
	Wind, DJohnston, 43	-	-	-	-	-	-	-	-	-	-	-	-	-	-	-	-	-	-	-	-	25	-	25
	Total Wind	-	-	-	-	-	-	-	-	-	-	-	-	-	-	-	-	-	-	-	-	25	-	25
	Utility Solar - PV - East	-	-	-	-	-	-	-	-	-	-	-	-	-	-	-	-	-	100	-	54	-	-	154
	DSM, Class 2, ID	4	4	5	5	5	4	4	4	5	6	5	5	5	5	5	4	4	4	5	4	45	-	91
	DSM, Class 2, UT	69	78	84	86	92	81	85	90	94	93	75	81	80	80	79	73	72	73	73	71	851	-	1,607
	DSM, Class 2, WY	7	8	10	12	14	12	13	14	15	16	13	13	14	15	15	15	16	16	17	17	121	-	271
	DSM, Class 2 Total	79	90	99	102	111	97	102	108	113	115	92	99	99	99	98	92	93	94	94	92	1,017	-	1,969
	FOT Mona Q3	-	-	-	-	-	-	-	-	-	-	-	-	-	185	57	144	126	300	300	300	-	-	71
	Expansion Resources																							
	West																							
	Wind, YK, 29	-	-	-	-	-	-	-	-	261	-	-	-	-	-	-	-	-	-	-	-	-	261	261
	Total Wind	-	-	-	-	-	-	-	-	261	-	-	-	-	-	-	-	-	-	-	-	-	261	261
	Utility Solar - PV - West	-	-	-	-	-	-	-	-	-	-	-	-	-	-	-	-	-	-	-	599	-	-	599
	Oregon Solar Capacity Standard	-	7	-	-	-	-	-	-	-	-	-	-	-	-	-	-	-	-	-	-	7	-	7
DSM, Class 1, OR-Curtail	-	-	-	-	-	-	-	-	-	10.6	-	10.6	-	-	-	-	10.6	-	-	-	10.6	-	31.8	
DSM, Class 1, OR-DLC-RES	-	-	-	-	-	-	-	-	3.7	-	-	-	-	-	-	-	-	-	-	-	3.7	-	3.7	
DSM, Class 1, OR-Irrigate	-	-	-	-	-	-	-	5.0	-	-	3.4	-	-	-	-	-	-	-	-	-	5.0	-	8.4	
DSM, Class 1 Total	-	-	-	-	-	-	-	5.0	3.7	10.6	3.4	10.6	-	-	-	-	10.6	-	-	-	19.3	-	43.9	
DSM, Class 2, CA	1	2	2	2	2	1	1	2	2	2	1	1	1	1	1	1	1	1	1	1	16	-	29	
DSM, Class 2, OR	44	39	35	32	29	28	25	25	23	23	21	22	22	22	21	21	21	21	20	19	303	-	512	
DSM, Class 2, WA	8	9	10	10	11	9	10	10	11	11	9	9	9	9	9	8	8	8	8	8	7	-	98	
DSM, Class 2 Total	54	49	47	44	42	38	36	36	36	35	31	32	32	32	31	30	30	30	28	28	417	-	721	
FOT COB Q3	-	93	149	113	178	220	-	-	-	-	-	-	-	268	268	268	268	219	173	263	75	-	124	
FOT MidColumbia Q3	400	400	400	400	400	400	400	400	400	400	400	400	400	400	400	400	400	400	400	400	400	400	400	
FOT MidColumbia Q3 - 2	227	375	375	375	375	375	274	307	227	182	263	293	360	375	375	375	375	375	375	375	375	309	332	
FOT NOB Q3	100	100	100	100	100	100	100	100	100	100	100	100	100	100	100	100	100	100	100	100	100	100	100	
Existing Plant Retirements/Conversions	(222)	-	-	57	-	-	-	-	-	-	-	-	-	(762)	-	(1,144)	(77)	-	(627)	-	-	-	-	
Annual Additions, Long Term Resources	133	146	146	146	153	135	138	149	414	160	126	141	130	555	129	1,282	133	224	757	798	-	-		
Annual Additions, Short Term Resources	727	968	1,024	988	1,053	1,095	774	807	727	682	763	793	860	1,328	1,200	1,287	1,269	1,394	1,348	1,438	-	-		
Total Annual Additions	859	1,114	1,170	1,135	1,205	1,230	913	956	1,141	842	889	935	990	1,883	1,329	2,569	1,403	1,618	2,106	2,236	-	-		

1/ Front office transaction amounts reflect one-year transaction periods, are not additive, and are reported as a 10/20-year annual average.

Case C05a-3		Capacity (MW)																			Resource Totals 1/		
		2015	2016	2017	2018	2019	2020	2021	2022	2023	2024	2025	2026	2027	2028	2029	2030	2031	2032	2033	2034	10-year	20-year
East	Existing Plant Retirements/Conversions																						
	Hayden 1	-	-	-	-	-	-	-	-	-	-	-	-	-	-	-	-	(45)	-	-	-	-	(45)
	Hayden 2	-	-	-	-	-	-	-	-	-	-	-	-	-	-	-	-	(33)	-	-	-	-	(33)
	Hunter 2 (Coal Early Retirement/Conversions)	-	-	-	-	-	-	-	-	-	-	-	-	-	-	-	-	-	-	(269)	-	-	(269)
	Huntington 2 (Coal Early Retirement/Conversions)	-	-	-	-	-	-	-	-	-	-	-	-	-	-	-	-	(450)	-	-	-	-	(450)
	Carbon 1 (Coal Early Retirement/Conversions)	(67)	-	-	-	-	-	-	-	-	-	-	-	-	-	-	-	-	-	-	-	(67)	(67)
	Carbon 2 (Coal Early Retirement/Conversions)	(105)	-	-	-	-	-	-	-	-	-	-	-	-	-	-	-	-	-	-	-	(105)	(105)
	Cholla 4 (Coal Early Retirement/Conversions)	-	-	-	-	-	-	-	-	-	-	(387)	-	-	-	-	-	-	-	-	-	-	(387)
	DaveJohnston 1	-	-	-	-	-	-	-	-	-	-	-	-	-	(106)	-	-	-	-	-	-	-	(106)
	DaveJohnston 2	-	-	-	-	-	-	-	-	-	-	-	-	-	(106)	-	-	-	-	-	-	-	(106)
	DaveJohnston 3	-	-	-	-	-	-	-	-	-	-	-	-	-	(220)	-	-	-	-	-	-	-	(220)
	DaveJohnston 4	-	-	-	-	-	-	-	-	-	-	-	-	-	(330)	-	-	-	-	-	-	-	(330)
	Naughton 1	-	-	-	-	-	-	-	-	-	-	-	-	-	-	-	(156)	-	-	-	-	-	(156)
	Naughton 2	-	-	-	-	-	-	-	-	-	-	-	-	-	-	-	(201)	-	-	-	-	-	(201)
	Naughton 3 (Coal Early Retirement/Conversions)	(50)	-	-	(280)	-	-	-	-	-	-	-	-	-	-	-	-	-	-	-	-	(330)	(330)
	Cadsby 1-6	-	-	-	-	-	-	-	-	-	-	-	-	-	-	-	-	-	-	(358)	-	-	(358)
	Coal Ret_AZ - Gas RePower	-	-	-	-	-	-	-	-	-	-	387	-	-	-	-	-	-	-	-	-	-	387
	Coal Ret_WY - Gas RePower	-	-	-	337	-	-	-	-	-	-	-	-	-	-	-	(337)	-	-	-	-	337	-
	Expansion Resources																						
	CCCT - DJohns - F 1x1	-	-	-	-	-	-	-	-	-	-	-	-	-	-	-	313	-	-	-	-	-	313
	CCCT - DJohns - J 1x1	-	-	-	-	-	-	-	-	-	-	-	-	-	423	-	-	-	-	-	-	-	423
	CCCT - Utah-N - F 2x1	-	-	-	-	-	-	-	-	-	-	-	-	-	-	-	-	-	-	635	-	-	635
	CCCT - Utah-S - J 1x1	-	-	-	-	-	-	-	-	-	-	-	-	-	-	-	846	-	-	-	-	-	846
	Total CCCT	-	-	-	-	-	-	-	-	-	-	-	-	-	423	-	1,159	-	-	635	-	-	2,217
	Wind, DJohnston, 43	-	-	-	-	-	-	-	-	-	-	-	-	-	-	-	-	-	-	-	26	-	26
	Total Wind	-	-	-	-	-	-	-	-	-	-	-	-	-	-	-	-	-	-	-	26	-	26
	Utility Solar - PV - East	-	-	-	-	-	-	-	-	-	-	-	-	-	-	-	-	-	100	-	54	-	154
	DSM, Class 1, ID-Irrigate	-	-	-	-	-	-	-	-	-	-	-	-	-	-	-	-	-	-	-	25.9	-	25.9
	DSM, Class 1, UT-DLC-RES	-	-	-	-	-	-	-	-	-	-	-	-	-	-	-	-	-	4.9	-	-	-	4.9
	DSM, Class 1, UT-Irrigate	-	-	-	-	-	-	-	-	-	-	-	-	-	-	-	-	-	-	-	19.0	-	19.0
	DSM, Class 1 Total	-	-	-	-	-	-	-	-	-	-	-	-	-	-	-	-	-	4.9	-	45.0	-	49.9
	DSM, Class 2, ID	4	4	5	5	5	4	4	4	5	6	5	5	5	5	5	4	4	5	4	4	46	92
	DSM, Class 2, UT	69	78	84	86	94	83	86	90	91	93	81	81	84	84	81	75	76	75	73	73	852	1,634
	DSM, Class 2, WY	7	8	10	12	14	12	13	14	15	16	13	13	14	15	15	15	16	16	17	17	122	273
	DSM, Class 2 Total	79	90	99	102	113	99	103	108	111	115	99	99	103	104	101	95	96	96	94	94	1,020	1,999
	FOT Mona Q3	-	-	-	-	-	-	-	-	-	-	-	-	44	248	117	191	182	300	300	300	-	84
	Expansion Resources																						
Utility Solar - PV - West	-	-	-	-	-	-	-	-	-	-	-	-	-	-	-	-	-	-	-	584	-	584	
Oregon Solar Capacity Standard	-	7	-	-	-	-	-	-	-	-	-	-	-	-	-	-	-	-	-	-	7	7	
DSM, Class 1, OR-Curtail	-	-	-	-	-	-	-	-	10.6	-	-	10.6	-	-	-	10.6	-	-	-	-	10.6	31.8	
DSM, Class 1, OR-Irrigate	-	-	-	-	-	-	-	5.0	-	-	-	-	-	-	-	-	-	-	-	-	5.0	5.0	
DSM, Class 1 Total	-	-	-	-	-	-	-	5.0	10.6	-	-	10.6	-	-	-	10.6	-	-	-	-	15.6	36.8	
DSM, Class 2, CA	1	2	2	2	2	1	1	2	2	2	1	1	1	1	1	1	1	1	1	1	16	29	
DSM, Class 2, OR	44	39	36	33	29	27	25	25	23	24	22	22	22	22	21	21	21	21	20	20	304	514	
DSM, Class 2, WA	8	9	10	10	11	9	10	10	11	11	9	9	9	9	9	8	8	8	8	7	98	181	
DSM, Class 2 Total	54	50	47	44	42	38	36	36	36	36	32	32	32	32	30	30	30	28	28	28	418	724	
FOT COB Q3	-	93	148	113	176	217	-	-	-	-	-	-	7	268	268	268	268	222	268	268	75	129	
FOT MidColumbia Q3	400	400	400	400	400	400	400	400	400	400	400	400	400	400	400	400	400	400	400	400	400	400	
FOT MidColumbia Q3 - 2	226	375	375	375	375	375	271	303	289	254	333	363	375	375	375	375	375	375	375	375	322	346	
FOT NOB Q3	100	100	100	100	100	100	100	100	100	100	100	100	100	100	100	100	100	100	100	100	100	100	
Existing Plant Retirements/Conversions	(222)	-	-	57	-	-	-	-	-	-	-	-	-	(762)	-	(1,144)	(77)	-	(627)	-	-	-	
Annual Additions, Long Term Resources	133	147	146	147	155	137	139	149	157	151	130	141	135	559	132	1,295	126	231	757	831			
Annual Additions, Short Term Resources	726	968	1,023	988	1,051	1,092	771	803	789	754	833	863	926	1,391	1,260	1,334	1,325	1,443	1,397	1,443			
Total Annual Additions	860	1,114	1,169	1,134	1,205	1,228	910	952	946	905	963	1,005	1,061	1,950	1,392	2,629	1,451	1,674	2,154	2,274			

1/ Front office transaction amounts reflect one-year transaction periods, are not additive, and are reported as a 10/20-year annual average.

Case C05a-3Q Preferred Portfolio		Capacity (MW)																				Resource Totals 1/		
		2015	2016	2017	2018	2019	2020	2021	2022	2023	2024	2025	2026	2027	2028	2029	2030	2031	2032	2033	2034	10-year	20-year	
East	Existing Plant Retirements/Conversions																							
	Hayden 1	-	-	-	-	-	-	-	-	-	-	-	-	-	-	-	-	-	(45)	-	-	-	-	(45)
	Hayden 2	-	-	-	-	-	-	-	-	-	-	-	-	-	-	-	-	-	(33)	-	-	-	-	(33)
	Hunter 2 (Coal Early Retirement/Conversions)	-	-	-	-	-	-	-	-	-	-	-	-	-	-	-	-	-	-	-	(269)	-	-	(269)
	Huntington 2 (Coal Early Retirement/Conversions)	-	-	-	-	-	-	-	-	-	-	-	-	-	-	-	-	-	-	-	-	-	-	(450)
	Carbon 1 (Coal Early Retirement/Conversions)	(67)	-	-	-	-	-	-	-	-	-	-	-	-	-	-	-	-	-	-	-	-	-	(67)
	Carbon 2 (Coal Early Retirement/Conversions)	(105)	-	-	-	-	-	-	-	-	-	-	-	-	-	-	-	-	-	-	-	-	-	(105)
	Cholla 4 (Coal Early Retirement/Conversions)	-	-	-	-	-	-	-	-	-	-	(387)	-	-	-	-	-	-	-	-	-	-	-	(387)
	DaveJohnston 1	-	-	-	-	-	-	-	-	-	-	-	-	-	-	-	(106)	-	-	-	-	-	-	(106)
	DaveJohnston 2	-	-	-	-	-	-	-	-	-	-	-	-	-	-	-	(106)	-	-	-	-	-	-	(106)
	DaveJohnston 3	-	-	-	-	-	-	-	-	-	-	-	-	-	-	-	(220)	-	-	-	-	-	-	(220)
	DaveJohnston 4	-	-	-	-	-	-	-	-	-	-	-	-	-	-	-	(330)	-	-	-	-	-	-	(330)
	Naughton 1	-	-	-	-	-	-	-	-	-	-	-	-	-	-	-	-	-	(156)	-	-	-	-	(156)
	Naughton 2	-	-	-	-	-	-	-	-	-	-	-	-	-	-	-	-	-	(201)	-	-	-	-	(201)
	Naughton 3 (Coal Early Retirement/Conversions)	(50)	-	-	(280)	-	-	-	-	-	-	-	-	-	-	-	-	-	-	-	-	-	(330)	(330)
	Gadsby 1-6	-	-	-	-	-	-	-	-	-	-	-	-	-	-	-	-	-	-	-	-	(358)	-	(358)
	Coal Ret. AZ - Gas RePower	-	-	-	-	-	-	-	-	-	-	-	-	-	-	-	387	-	-	-	-	-	-	387
	Coal Ret. WY - Gas RePower	-	-	-	337	-	-	-	-	-	-	-	-	-	-	-	-	-	(337)	-	-	-	337	-
	Expansion Resources																							
	CCCT - DJohns - F 1xl	-	-	-	-	-	-	-	-	-	-	-	-	-	-	-	-	-	313	-	-	-	-	313
	CCCT - DJohns - J 1xl	-	-	-	-	-	-	-	-	-	-	-	-	-	-	-	-	-	-	-	-	-	-	423
	CCCT - Utah-N - F 2xl	-	-	-	-	-	-	-	-	-	-	-	-	-	-	-	-	-	-	-	-	635	635	1,270
	CCCT - Utah-S - J 1xl	-	-	-	-	-	-	-	-	-	-	-	-	-	-	-	-	-	846	-	-	-	-	846
	Total CCCT	-	-	-	-	-	-	-	-	-	-	-	-	-	-	-	-	-	423	-	-	635	635	2,852
	DSM, Class 1, UT-DLC-RES	-	-	-	-	-	-	-	-	-	-	-	-	-	-	-	-	-	-	-	-	4.9	-	4.9
DSM, Class 1 Total	-	-	-	-	-	-	-	-	-	-	-	-	-	-	-	-	-	-	-	-	4.9	-	4.9	
DSM, Class 2, ID	4	4	5	5	5	4	4	4	5	5	5	5	5	5	5	4	4	4	4	5	4	45	90	
DSM, Class 2, UT	69	78	84	86	92	81	84	90	91	93	75	76	80	80	77	75	72	72	73	70	847	1,596		
DSM, Class 2, WY	6	8	10	12	14	12	13	14	15	16	13	13	14	15	15	15	16	16	17	17	121	271		
DSM, Class 2 Total	79	90	99	102	111	97	101	108	110	114	92	94	99	99	97	94	93	92	94	92	1,012	1,958		
FOT Mona Q3	-	-	-	-	-	-	-	-	-	-	-	-	-	-	-	161	44	110	104	268	300	74	53	
West	Expansion Resources																							
	Oregon Solar Capacity Standard	-	7	-	-	-	-	-	-	-	-	-	-	-	-	-	-	-	-	-	-	7	7	
	DSM, Class 1, OR-Curtail	-	-	-	-	-	-	-	-	-	10.6	-	-	10.6	-	-	10.6	-	-	-	-	10.6	31.8	
	DSM, Class 1, OR-Irrigate	-	-	-	-	-	-	-	-	5.0	-	-	-	-	-	-	-	-	-	-	-	5.0	5.0	
	DSM, Class 1 Total	-	-	-	-	-	-	-	-	5.0	10.6	-	-	10.6	-	-	10.6	-	-	-	-	15.6	36.8	
	DSM, Class 2, CA	1	2	2	2	2	1	1	2	2	2	1	1	1	1	1	1	1	1	1	1	16	29	
	DSM, Class 2, OR	44	39	36	33	29	27	25	25	23	23	21	22	22	22	21	21	20	21	20	20	303	511	
	DSM, Class 2, WA	8	9	10	10	11	9	10	10	11	11	9	9	9	9	9	8	8	8	8	7	98	181	
	DSM, Class 2 Total	54	49	47	44	42	38	36	36	36	35	31	32	32	32	31	30	29	30	28	28	417	721	
	FOT COB Q3	-	62	29	-	60	104	-	-	-	-	-	-	-	268	248	268	268	268	185	138	26	95	
	FOT MidColumbia Q3	400	400	400	400	400	400	400	400	400	400	400	400	400	400	400	400	400	400	400	400	400	400	
	FOT MidColumbia Q3-2	227	375	375	370	375	375	269	291	261	254	271	292	335	375	375	375	375	375	375	375	317	335	
	FOT NOB Q3	100	100	100	100	100	100	100	100	100	100	100	100	100	100	100	100	100	100	100	100	100	100	
	Existing Plant Retirements/Conversions	(222)	-	-	57	-	-	-	-	-	-	-	-	-	-	-	(762)	-	(1,144)	(77)	-	-	-	
Annual Additions, Long Term Resources	133	146	146	146	153	135	137	149	157	149	123	137	130	555	139	1,284	122	122	762	755	-	-		
Annual Additions, Short Term Resources	727	937	904	870	935	979	769	791	761	754	771	792	835	1,304	1,167	1,253	1,247	1,411	1,360	1,087	-	-		
Total Annual Additions	860	1,084	1,050	1,016	1,088	1,113	906	941	917	903	893	928	965	1,859	1,305	2,537	1,369	1,533	2,123	1,841	-	-		

1/ Front office transaction amounts reflect one-year transaction periods, are not additive, and are reported as a 10-20-year annual average.

Case C05b-3		Capacity (MW)																				Resource Totals 1/		
		2015	2016	2017	2018	2019	2020	2021	2022	2023	2024	2025	2026	2027	2028	2029	2030	2031	2032	2033	2034	10-year	20-year	
East	Existing Plant Retirements/Conversions																							
	Hayden 1	-	-	-	-	-	-	-	-	-	-	-	-	-	-	-	-	-	(45)	-	-	-	-	(45)
	Hayden 2	-	-	-	-	-	-	-	-	-	-	-	-	-	-	-	-	-	(33)	-	-	-	-	(33)
	Hunter 2 (Coal Early Retirement/Conversions)	-	-	-	-	-	-	-	-	-	-	-	-	-	-	-	-	-	-	-	(269)	-	-	(269)
	Huntington 2 (Coal Early Retirement/Conversions)	-	-	-	-	-	-	-	-	-	-	-	-	-	-	-	-	(450)	-	-	-	-	-	(450)
	Carbon 1 (Coal Early Retirement/Conversions)	(67)	-	-	-	-	-	-	-	-	-	-	-	-	-	-	-	-	-	-	-	-	(67)	(67)
	Carbon 2 (Coal Early Retirement/Conversions)	(105)	-	-	-	-	-	-	-	-	-	-	-	-	-	-	-	-	-	-	-	-	(105)	(105)
	Cholla 4 (Coal Early Retirement/Conversions)	-	-	-	-	-	-	-	-	-	-	(387)	-	-	-	-	-	-	-	-	-	-	-	(387)
	DaveJohnston 1	-	-	-	-	-	-	-	-	-	-	-	-	-	(106)	-	-	-	-	-	-	-	-	(106)
	DaveJohnston 2	-	-	-	-	-	-	-	-	-	-	-	-	-	(106)	-	-	-	-	-	-	-	-	(106)
	DaveJohnston 3	-	-	-	-	-	-	-	-	-	-	-	-	-	(220)	-	-	-	-	-	-	-	-	(220)
	DaveJohnston 4	-	-	-	-	-	-	-	-	-	-	-	-	-	(330)	-	-	-	-	-	-	-	-	(330)
	Naughton 1	-	-	-	-	-	-	-	-	-	-	-	-	-	-	-	(156)	-	-	-	-	-	-	(156)
	Naughton 2	-	-	-	-	-	-	-	-	-	-	-	-	-	-	-	(201)	-	-	-	-	-	-	(201)
	Naughton 3 (Coal Early Retirement/Conversions)	(50)	-	-	(280)	-	-	-	-	-	-	-	-	-	-	-	-	-	-	-	-	-	(330)	(330)
	Gadsby 1-6	-	-	-	-	-	-	-	-	-	-	-	-	-	-	-	-	-	-	(358)	-	-	-	(358)
	Coal Ret. AZ - Gas RePower	-	-	-	-	-	-	-	-	-	-	387	-	-	-	-	-	-	-	-	-	-	-	387
	Coal Ret. WY - Gas RePower	-	-	-	337	-	-	-	-	-	-	-	-	-	-	-	-	(337)	-	-	-	-	337	-
	Expansion Resources																							
	CCCT - DJohns - F 1xl	-	-	-	-	-	-	-	-	-	-	-	-	-	-	-	313	-	-	-	-	-	-	313
	CCCT - DJohns - J 1xl	-	-	-	-	-	-	-	-	-	-	-	-	-	423	-	-	-	-	-	-	-	-	423
	CCCT - Utah-N - F 2xl	-	-	-	-	-	-	-	-	-	-	-	-	-	-	-	-	-	-	635	-	-	-	635
	CCCT - Utah-S - J 1xl	-	-	-	-	-	-	-	-	-	-	-	-	-	-	-	846	-	-	-	-	-	-	846
	Total CCCT	-	-	-	-	-	-	-	-	-	-	-	-	-	423	-	1,159	-	-	635	-	-	-	2,217
	Wind, DJohnston, 43	-	-	-	-	-	-	-	-	-	-	-	-	-	-	-	-	-	-	-	-	25	-	25
	Total Wind	-	-	-	-	-	-	-	-	-	-	-	-	-	-	-	-	-	-	-	-	25	-	25
	Utility Solar - PV - East	-	-	-	-	-	-	-	-	-	-	-	-	-	-	-	-	-	100	-	-	54	-	154
	DSM, Class 2, ID	4	4	5	5	4	4	4	5	6	5	5	5	5	5	4	4	4	4	4	4	45	91	
	DSM, Class 2, UT	69	78	84	86	92	81	85	90	94	93	75	81	80	80	79	73	72	71	73	71	851	1,605	
	DSM, Class 2, WY	7	8	10	12	14	12	13	14	15	16	13	13	14	15	15	15	16	16	17	17	121	271	
	DSM, Class 2 Total	79	90	99	102	111	97	102	108	114	115	92	99	99	99	98	92	93	92	94	92	1,017	1,967	
	FOT Mona Q3	-	-	-	-	-	-	-	-	-	-	-	-	44	139	44	98	80	217	300	300	-	61	
	Expansion Resources																							
	West																							
	Wind, WW, 29	-	-	-	-	-	-	-	-	-	-	-	-	-	48	-	-	-	-	-	-	-	-	48
	Wind, YK, 29	-	-	-	-	-	-	-	-	-	-	-	-	-	400	-	-	-	-	-	-	-	-	400
	Total Wind	-	-	-	-	-	-	-	-	-	-	-	-	-	448	-	-	-	-	-	-	-	-	448
	Utility Solar - PV - West	-	-	-	-	-	-	-	-	-	-	-	-	-	-	-	-	-	-	-	-	599	-	599
Oregon Solar Capacity Standard	-	7	-	-	-	-	-	-	-	-	-	-	-	-	-	-	-	-	-	-	7	-	7	
DSM, Class 1, OR-Curtail	-	-	-	-	-	-	-	-	10.6	-	-	10.6	-	-	-	10.6	-	-	-	-	10.6	-	31.8	
DSM, Class 1, OR-Irrigate	-	-	-	-	-	-	-	5.0	-	-	3.4	-	-	-	-	-	-	-	-	-	0.3	-	8.7	
DSM, Class 1 Total	-	-	-	-	-	-	-	5.0	10.6	-	3.4	10.6	-	-	-	-	-	-	-	0.3	15.6	-	40.5	
DSM, Class 2, CA	1	2	2	2	2	1	1	2	2	2	1	1	1	1	1	1	1	1	1	1	16	29		
DSM, Class 2, OR	44	39	35	32	29	28	25	25	23	23	21	22	22	22	21	21	21	21	20	19	303	511		
DSM, Class 2, WA	8	9	10	10	11	9	10	10	11	11	9	9	9	9	9	8	8	8	8	7	98	181		
DSM, Class 2 Total	54	49	47	44	42	38	36	36	36	35	31	32	32	32	31	30	30	30	28	28	417	721		
FOT COB Q3	-	93	149	113	178	220	-	-	-	-	-	-	15	268	235	268	268	257	129	218	75	121		
FOT MidColumbia Q3	400	400	400	400	400	400	400	400	400	400	400	400	400	400	400	400	400	400	400	400	400	400	400	
FOT MidColumbia Q3 - 2	227	375	375	375	375	375	274	307	291	255	337	367	375	375	375	375	375	375	375	375	375	323	347	
FOT NOB Q3	100	100	100	100	100	100	100	100	100	100	100	100	100	100	100	100	100	100	100	100	100	100	100	
Existing Plant Retirements/Conversions	(222)	-	-	57	-	-	-	-	-	-	-	-	-	(762)	-	(1,144)	(77)	-	(627)	-	-	-	-	
Annual Additions, Long Term Resources	133	146	146	146	153	135	138	149	160	150	126	141	130	1,003	129	1,282	133	222	757	799	-	-		
Annual Additions, Short Term Resources	727	968	1,024	988	1,053	1,095	774	807	791	755	837	867	934	1,282	1,154	1,241	1,223	1,350	1,304	1,393	-	-		
Total Annual Additions	859	1,114	1,170	1,135	1,205	1,230	913	956	950	905	963	1,009	1,064	2,285	1,283	2,523	1,357	1,572	2,061	2,192	-	-		

1/ Front office transaction amounts reflect one-year transaction periods, are not additive, and are reported as a 10/20-year annual average.

Case C06-1		Capacity (MW)																			Resource Totals 1/			
		2015	2016	2017	2018	2019	2020	2021	2022	2023	2024	2025	2026	2027	2028	2029	2030	2031	2032	2033	2034	10-year	20-year	
East	Existing Plant Retirements/Conversions																							
	Hayden 1	-	-	-	-	-	-	-	-	-	-	-	-	-	-	-	-	-	(45)	-	-	-	-	(45)
	Hayden 2	-	-	-	-	-	-	-	-	-	-	-	-	-	-	-	-	-	(33)	-	-	-	-	(33)
	Hunter 2 (Coal Early Retirement/Conversions)	-	-	-	-	-	-	-	-	-	-	-	-	-	-	-	-	-	-	-	(269)	-	-	(269)
	Huntington 2 (Coal Early Retirement/Conversions)	-	-	-	-	-	-	-	(450)	-	-	-	-	-	-	-	-	-	-	-	-	-	(450)	(450)
	Carbon 1 (Coal Early Retirement/Conversions)	(67)	-	-	-	-	-	-	-	-	-	-	-	-	-	-	-	-	-	-	-	-	(67)	(67)
	Carbon 2 (Coal Early Retirement/Conversions)	(105)	-	-	-	-	-	-	-	-	-	-	-	-	-	-	-	-	-	-	-	-	(105)	(105)
	Cholla 4 (Coal Early Retirement/Conversions)	-	-	-	-	-	-	-	-	-	-	(387)	-	-	-	-	-	-	-	-	-	-	-	(387)
	DaveJohnston 1 (Coal Early Retirement/Conversions)	-	-	-	-	(106)	-	-	-	-	-	-	-	-	-	-	-	-	-	-	-	-	(106)	(106)
	DaveJohnston 2	-	-	-	-	-	-	-	-	-	-	-	-	-	(106)	-	-	-	-	-	-	-	-	(106)
	DaveJohnston 3	-	-	-	-	-	-	-	-	-	-	-	-	-	(220)	-	-	-	-	-	-	-	-	(220)
	DaveJohnston 4	-	-	-	-	-	-	-	-	-	-	-	-	-	-	-	-	-	-	-	(330)	-	-	(330)
	Naughton 1	-	-	-	-	-	-	-	-	-	-	-	-	-	-	-	(156)	-	-	-	-	-	-	(156)
	Naughton 2	-	-	-	-	-	-	-	-	-	-	-	-	-	-	-	(201)	-	-	-	-	-	-	(201)
	Naughton 3 (Coal Early Retirement/Conversions)	(50)	-	-	(280)	-	-	-	-	-	-	-	-	-	-	-	-	-	-	-	-	-	(330)	(330)
	Cadsby 1-6	-	-	-	-	-	-	-	-	-	-	-	-	-	-	-	-	-	-	-	(358)	-	-	(358)
	Coal Ret_AZ - Gas RePower	-	-	-	-	-	-	-	-	-	-	387	-	-	-	-	-	-	-	-	-	-	-	387
	Coal Ret_WY - Gas RePower	-	-	-	337	-	-	-	-	-	-	-	-	-	-	-	-	(337)	-	-	-	-	337	-
	Expansion Resources																							
	CCCT - DJohns - F 1x1	-	-	-	-	-	-	-	-	-	-	-	-	-	-	313	-	-	-	-	-	-	-	313
	CCCT - DJohns - J 1x1	-	-	-	-	-	-	-	-	-	-	-	-	-	-	-	-	-	-	-	423	-	-	423
	CCCT - Huntington - J 1x1	-	-	-	-	-	-	-	-	-	-	-	-	-	-	-	-	-	-	-	423	-	-	423
	CCCT - Naughton - J 1x1	-	-	-	-	-	-	-	-	-	-	-	-	-	-	-	-	-	-	401	-	-	-	401
	CCCT - Utah-N - F 2x1	-	-	-	-	-	-	-	-	-	-	-	-	-	-	-	-	-	-	-	-	635	-	635
	CCCT - Utah-S - J 1x1	-	-	-	-	-	-	-	-	-	-	-	-	-	-	-	-	-	423	-	423	-	-	846
	Total CCCT	-	-	-	-	-	-	-	-	-	-	-	-	-	-	313	-	423	-	401	1,269	635	-	3,041
	Wind, DJohnston, 43	-	-	-	-	-	25	-	-	-	-	-	-	-	-	-	-	-	-	-	-	-	25	25
Total Wind	-	-	-	-	-	25	-	-	-	-	-	-	-	-	-	-	-	-	-	-	-	25	25	
Utility Solar - PV - East	-	-	-	-	-	-	-	150	-	-	-	-	-	-	-	-	-	-	-	-	-	150	150	
DSM, Class 2, ID	4	4	10	10	10	9	9	9	9	9	8	8	7	7	7	6	6	6	6	6	6	82	149	
DSM, Class 2, UT	69	78	115	112	122	109	112	122	124	123	105	119	121	121	118	105	104	102	102	101	1,083	2,180		
DSM, Class 2, WY	6	8	18	20	23	21	22	23	24	25	20	20	20	21	21	20	21	21	21	22	192	399		
DSM, Class 2 Total	79	90	143	142	154	138	143	154	157	157	132	147	148	149	146	132	130	130	129	128	1,357	2,728		
FOT Mona Q3	-	-	-	-	-	-	-	-	-	32	77	61	79	178	44	278	225	76	300	8	3	68		
West	Existing Plant Retirements/Conversions																							
	JimBridger 1 (Coal Early Retirement/Conversions)	-	-	-	-	-	-	-	-	-	(354)	-	-	-	-	-	-	-	-	-	-	-	(354)	(354)
	JimBridger 2 (Coal Early Retirement/Conversions)	-	-	-	-	-	-	-	-	-	-	-	-	-	-	-	-	-	-	-	(359)	-	-	(359)
	Expansion Resources																							
	Oregon Solar Capacity Standard	-	7	-	-	-	-	-	-	-	-	-	-	-	-	-	-	-	-	-	-	-	7	7
	DSM, Class 1, OR-Curtail	-	-	-	-	-	-	-	-	-	10.6	-	10.6	-	-	-	-	-	10.6	-	-	-	10.6	31.8
	DSM, Class 1, OR-Irrigate	-	-	-	-	-	-	-	3.4	5.0	-	-	-	-	-	-	-	-	-	-	-	-	8.4	8.4
	DSM, Class 1 Total	-	-	-	-	-	-	-	3.4	5.0	10.6	-	10.6	-	-	-	-	-	10.6	-	-	-	19.0	40.2
	DSM, Class 2, CA	1	2	3	3	4	3	3	3	3	3	3	3	3	3	3	2	2	2	2	2	2	28	51
	DSM, Class 2, OR	44	39	60	58	51	48	46	44	41	39	37	36	37	37	35	33	33	33	30	30	470	809	
	DSM, Class 2, WA	8	9	20	19	19	17	17	18	18	18	14	14	14	14	13	11	11	11	10	10	164	285	
	DSM, Class 2 Total	54	49	83	80	74	68	66	64	63	61	54	53	53	53	50	46	45	45	42	42	662	1,145	
	FOT COB Q3	-	93	100	19	137	131	-	116	57	268	268	268	268	268	228	268	268	193	17	-	92	148	
	FOT MidColumbia Q3	400	400	400	400	400	400	400	400	400	400	400	400	400	400	400	400	400	400	400	400	400	400	400
	FOT MidColumbia Q3 - 2	227	375	375	375	375	375	192	375	375	375	375	375	375	375	375	375	375	375	375	375	342	358	
	FOT NOB Q3	100	100	100	100	100	100	100	100	100	100	100	100	100	100	100	100	100	100	100	100	100	100	100
	Existing Plant Retirements/Conversions	(222)	-	-	57	(106)	-	-	(450)	-	(354)	-	-	-	(326)	-	(694)	(77)	-	(1,316)	-	-	-	-
	Annual Additions, Long Term Resources	132	146	226	221	229	232	209	371	225	229	186	210	201	516	196	601	186	576	1,440	805	-	-	
	Annual Additions, Short Term Resources	727	968	975	894	1,012	1,006	692	991	932	1,175	1,220	1,204	1,222	1,321	1,147	1,421	1,368	1,144	1,192	883	-	-	
	Total Annual Additions	859	1,115	1,200	1,116	1,240	1,237	901	1,362	1,156	1,404	1,405	1,414	1,424	1,837	1,343	2,022	1,554	1,720	2,632	1,688	-	-	

1/ Front office transaction amounts reflect one-year transaction periods, are not additive, and are reported as a 10/20-year annual average.

Case C06-2		Capacity (MW)																		Resource Totals 1/			
		2015	2016	2017	2018	2019	2020	2021	2022	2023	2024	2025	2026	2027	2028	2029	2030	2031	2032	2033	2034	10-year	20-year
East	Existing Plant Retirements/Conversions																						
	Hayden 1	-	-	-	-	-	-	-	-	-	-	-	-	-	-	-	-	(45)	-	-	-	-	(45)
	Hayden 2	-	-	-	-	-	-	-	-	-	-	-	-	-	-	-	-	(33)	-	-	-	-	(33)
	Hunter 2 (Coal Early Retirement/Conversions)	-	-	-	-	-	-	-	-	-	-	(269)	-	-	-	-	-	-	-	-	-	-	(269)
	Huntington 1 (Coal Early Retirement/Conversions)	-	-	-	-	-	-	-	-	-	-	(459)	-	-	-	-	-	-	-	-	-	-	(459)
	Huntington 2 (Coal Early Retirement/Conversions)	-	-	-	-	-	-	-	-	(450)	-	-	-	-	-	-	-	-	-	-	-	(450)	(450)
	Carbon 1 (Coal Early Retirement/Conversions)	(67)	-	-	-	-	-	-	-	-	-	-	-	-	-	-	-	-	-	-	-	(67)	(67)
	Carbon 2 (Coal Early Retirement/Conversions)	(105)	-	-	-	-	-	-	-	-	-	-	-	-	-	-	-	-	-	-	-	(105)	(105)
	Cholla 4 (Coal Early Retirement/Conversions)	-	-	-	-	-	-	-	-	-	-	(387)	-	-	-	-	-	-	-	-	-	-	(387)
	DaveJohnston 1 (Coal Early Retirement/Conversions)	-	-	-	-	(106)	-	-	-	-	-	-	-	-	-	-	-	-	-	-	-	(106)	(106)
	DaveJohnston 2 (Coal Early Retirement/Conversions)	-	-	-	-	-	-	-	-	-	(106)	-	-	-	-	-	-	-	-	-	-	(106)	(106)
	DaveJohnston 3	-	-	-	-	-	-	-	-	-	-	-	-	-	(220)	-	-	-	-	-	-	-	(220)
	DaveJohnston 4	-	-	-	-	-	-	-	-	-	-	-	-	-	-	-	-	-	(330)	-	-	-	(330)
	Naughton 1	-	-	-	-	-	-	-	-	-	-	-	-	-	-	-	(156)	-	-	-	-	-	(156)
	Naughton 2	-	-	-	-	-	-	-	-	-	-	-	-	-	-	-	(201)	-	-	-	-	-	(201)
	Naughton 3 (Coal Early Retirement/Conversions)	(50)	-	-	(280)	-	-	-	-	-	-	-	-	-	-	-	-	-	-	-	-	(330)	(330)
	Wyodak (Coal Early Retirement/Conversions)	-	-	-	-	-	-	-	-	-	-	-	-	-	-	-	-	-	(268)	-	-	-	(268)
	Cadby 1-6	-	-	-	-	-	-	-	-	-	-	-	-	-	-	-	-	-	(358)	-	-	-	(358)
	Coal Ret. AZ - Gas RePower	-	-	-	-	-	-	-	-	-	-	387	-	-	-	-	-	-	-	-	-	-	387
	Coal Ret. WY - Gas RePower	-	-	-	337	-	-	-	-	-	-	-	-	-	-	-	(337)	-	-	-	-	337	-
	Expansion Resources																						
	CCCT - DJohns - F 1xl	-	-	-	-	-	-	-	-	-	-	-	-	-	-	-	-	-	313	-	-	-	313
	CCCT - DJohns - J 1xl	-	-	-	-	-	-	-	-	-	-	-	-	-	-	-	-	-	423	-	-	-	423
	CCCT - Huntington - J 1xl	-	-	-	-	-	-	-	-	-	-	846	-	-	-	-	-	-	-	-	-	-	846
	CCCT - Naughton - J 1xl	-	-	-	-	-	-	-	-	-	-	-	-	-	-	-	401	-	-	-	-	-	401
	CCCT - Utah-N - F 2xl	-	-	-	-	-	-	-	-	-	-	-	-	-	-	-	-	-	635	-	-	-	635
	CCCT - Utah-S - J 1xl	-	-	-	-	-	-	-	-	-	-	-	-	-	423	-	423	-	-	-	-	-	846
	Total CCCT	-	-	-	-	-	-	-	-	-	-	846	-	-	423	-	824	-	1,371	-	-	-	3,464
	Wind, DJohnston, 43	-	-	-	-	-	25	-	-	-	-	-	-	-	-	-	-	-	-	-	-	25	25
	Total Wind	-	-	-	-	-	25	-	-	-	-	-	-	-	-	-	-	-	-	-	-	25	25
	Utility Solar - PV - East	-	-	-	-	-	-	-	150	-	-	-	-	-	-	-	-	-	-	-	-	150	150
	DSM, Class 1, UT-DLC-RES	-	-	-	-	-	-	-	-	-	-	-	-	-	-	-	-	-	4.9	-	-	-	4.9
	DSM, Class 1 Total	-	-	-	-	-	-	-	-	-	-	-	-	-	-	-	-	-	4.9	-	-	-	4.9
	DSM, Class 2, ID	4	4	10	10	10	9	9	9	9	9	8	8	7	7	7	6	6	6	6	6	82	149
	DSM, Class 2, UT	69	78	115	112	122	109	112	122	124	123	105	119	121	121	118	105	104	102	102	101	1,083	2,180
	DSM, Class 2, WY	6	8	18	20	23	21	22	23	24	25	20	20	20	21	21	20	21	21	21	22	192	399
DSM, Class 2 Total	79	90	143	142	154	138	143	154	157	132	147	148	149	146	132	131	130	129	129	1,357	2,728		
FOT Mona Q3	-	-	-	-	-	-	-	-	-	-	132	124	108	127	44	200	125	70	198	42	174	67	
Existing Plant Retirements/Conversions																							
JimBridger 1 (Coal Early Retirement/Conversions)	-	-	-	-	-	-	-	-	-	-	(354)	-	-	-	-	-	-	-	-	-	(354)	(354)	
JimBridger 2 (Coal Early Retirement/Conversions)	-	-	-	-	-	-	-	-	-	-	-	-	-	-	(359)	-	-	-	-	-	-	(359)	
Expansion Resources																							
Oregon Solar Capacity Standard	-	7	-	-	-	-	-	-	-	-	-	-	-	-	-	-	-	-	-	-	7	7	
DSM, Class 1, OR-Curtail	-	-	-	-	-	-	-	-	-	10.6	-	10.6	-	-	-	-	10.6	-	-	-	10.6	31.8	
DSM, Class 1, OR-Irrigate	-	-	-	-	-	-	-	3.4	5.0	-	-	-	-	-	-	-	-	-	-	-	8.4	8.4	
DSM, Class 1 Total	-	-	-	-	-	-	-	3.4	5.0	10.6	-	10.6	-	-	-	-	10.6	-	-	-	19.0	40.2	
DSM, Class 2, CA	1	2	3	3	4	3	3	3	3	3	3	3	3	3	3	2	2	2	2	2	28	51	
DSM, Class 2, OR	44	39	60	58	51	49	45	44	41	39	37	37	37	35	33	33	33	30	30	469	809		
DSM, Class 2, WA	8	9	20	19	19	17	17	18	18	18	14	14	14	14	13	11	11	11	10	10	164	285	
DSM, Class 2 Total	54	49	83	80	74	68	65	64	63	61	54	53	53	53	51	46	45	45	42	42	661	1,145	
FOT COB Q3	-	93	99	19	136	130	-	116	57	268	268	268	268	260	268	268	268	-	145	-	92	160	
FOT MidColumbia Q3	400	400	400	400	400	400	400	400	400	400	400	400	400	400	400	400	400	400	400	400	400	400	
FOT MidColumbia Q3 - 2	227	375	375	375	375	375	192	375	375	375	375	375	375	375	375	375	375	375	375	375	342	358	
FOT NOB Q3	100	100	100	100	100	100	100	100	100	100	100	100	100	100	100	100	100	100	100	100	100	100	
Existing Plant Retirements/Conversions	(222)	-	-	57	(106)	-	-	(450)	-	(460)	(728)	-	-	(220)	(359)	(694)	(77)	-	-	-	(956)	-	
Annual Additions, Long Term Resources	133	146	226	221	229	232	208	371	225	229	1,031	210	201	625	1,001	187	175	1,548	-	-	170	-	
Annual Additions, Short Term Resources	727	968	974	894	1,011	1,005	692	991	932	1,275	1,267	1,251	1,270	1,179	1,343	1,268	1,213	1,341	917	1,194	-	-	
Total Annual Additions	859	1,115	1,200	1,115	1,240	1,237	900	1,362	1,157	1,504	2,299	1,462	1,471	1,804	1,540	2,269	1,400	1,515	2,464	1,364	-	-	

1/ Front office transaction amounts reflect one-year transaction periods, are not additive, and are reported as a 10/20-year annual average.

Case C07-1		Capacity (MW)																			Resource Totals 1/			
		2015	2016	2017	2018	2019	2020	2021	2022	2023	2024	2025	2026	2027	2028	2029	2030	2031	2032	2033	2034	10-year	20-year	
East	Existing Plant Retirements/Conversions																							
	Hayden 1	-	-	-	-	-	-	-	-	-	-	-	-	-	-	-	-	(45)	-	-	-	-	(45)	
	Hayden 2	-	-	-	-	-	-	-	-	-	-	-	-	-	-	-	-	(33)	-	-	-	-	(33)	
	Hunter 2 (Coal Early Retirement/Conversions)	-	-	-	-	-	-	-	-	-	-	-	-	-	-	-	-	-	-	(269)	-	-	(269)	
	Huntington 2 (Coal Early Retirement/Conversions)	-	-	-	-	-	-	-	(450)	-	-	-	-	-	-	-	-	-	-	-	-	(450)	(450)	
	Carbon 1 (Coal Early Retirement/Conversions)	(67)	-	-	-	-	-	-	-	-	-	-	-	-	-	-	-	-	-	-	-	(67)	(67)	
	Carbon 2 (Coal Early Retirement/Conversions)	(105)	-	-	-	-	-	-	-	-	-	-	-	-	-	-	-	-	-	-	-	(105)	(105)	
	Cholla 4 (Coal Early Retirement/Conversions)	-	-	-	-	-	-	-	-	-	-	(387)	-	-	-	-	-	-	-	-	-	(387)	(387)	
	DaveJohnston 1 (Coal Early Retirement/Conversions)	-	-	-	-	(106)	-	-	-	-	-	-	-	-	-	-	-	-	-	-	-	(106)	(106)	
	DaveJohnston 2	-	-	-	-	-	-	-	-	-	-	-	-	-	(106)	-	-	-	-	-	-	(106)	(106)	
	DaveJohnston 3	-	-	-	-	-	-	-	-	-	-	-	-	-	(220)	-	-	-	-	-	-	(220)	(220)	
	DaveJohnston 4	-	-	-	-	-	-	-	-	-	-	-	-	-	-	-	-	-	-	(330)	-	(330)	(330)	
	Naughton 1	-	-	-	-	-	-	-	-	-	-	-	-	-	-	-	(156)	-	-	-	-	(156)	(156)	
	Naughton 2	-	-	-	-	-	-	-	-	-	-	-	-	-	-	-	(201)	-	-	-	-	(201)	(201)	
	Naughton 3 (Coal Early Retirement/Conversions)	(50)	-	-	(280)	-	-	-	-	-	-	-	-	-	-	-	-	-	-	-	-	(330)	(330)	
	Gadsby 1-6	-	-	-	-	-	-	-	-	-	-	-	-	-	-	-	-	-	-	(358)	-	(358)	(358)	
	Coal Ret_AZ - Gas RePower	-	-	-	-	-	-	-	-	-	-	387	-	-	-	-	-	-	-	-	-	387	387	
	Coal Ret_WY - Gas RePower	-	-	-	337	-	-	-	-	-	-	-	-	-	-	-	(337)	-	-	-	-	337	-	
	Expansion Resources																							
	CCCT - DJohns - F 1xl	-	-	-	-	-	-	-	-	-	-	-	-	-	313	-	-	-	-	-	-	-	313	
	CCCT - DJohns - J 1xl	-	-	-	-	-	-	-	-	-	-	-	-	-	-	-	-	-	-	423	-	-	423	
	CCCT - Huntington - J 1xl	-	-	-	-	-	-	-	-	-	-	-	-	-	-	-	-	-	-	423	-	-	423	
	CCCT - Naughton - J 1xl	-	-	-	-	-	-	-	-	-	-	-	-	-	-	-	-	-	401	-	-	-	401	
	CCCT - Utah-N - F 2xl	-	-	-	-	-	-	-	-	-	-	-	-	-	-	-	-	-	-	-	635	-	635	
	CCCT - Utah-S - J 1xl	-	-	-	-	-	-	-	-	-	-	-	-	-	-	-	-	423	-	-	423	-	846	
	Total CCCT	-	-	-	-	-	-	-	-	-	-	-	-	-	313	-	423	-	401	1,269	635	-	3,041	
	Wind, DJohnston, 43	-	-	-	-	-	25	-	-	-	-	-	-	-	-	-	-	-	-	-	-	-	25	
	Total Wind	-	-	-	-	-	25	-	-	-	-	-	-	-	-	-	-	-	-	-	-	-	25	
	Utility Solar - PV - East	-	-	-	-	-	154	-	-	-	-	-	-	-	-	-	-	-	-	-	-	154	154	
	DSM, Class 2, ID	4	4	10	10	10	9	9	9	9	9	8	8	7	7	7	6	6	6	6	6	6	82	149
	DSM, Class 2, UT	69	78	115	111	122	109	112	122	124	123	105	119	121	121	118	105	104	102	102	101	1,083	2,180	
	DSM, Class 2, WY	6	8	18	21	23	21	22	23	24	25	20	20	20	21	21	20	21	21	21	22	192	399	
	DSM, Class 2 Total	79	90	143	142	154	138	143	154	157	157	132	147	148	149	146	132	130	130	129	128	1,357	2,728	
	FOT Mona Q3	-	-	-	-	-	-	-	-	-	-	44	44	44	44	44	73	44	-	29	-	-	18	
	Existing Plant Retirements/Conversions																							
	JimBridger 1 (Coal Early Retirement/Conversions)	-	-	-	-	-	-	-	-	-	(354)	-	-	-	-	-	-	-	-	-	-	(354)	(354)	
	JimBridger 2 (Coal Early Retirement/Conversions)	-	-	-	-	-	-	-	-	-	-	-	-	-	-	-	-	-	-	(359)	-	(359)	(359)	
	Expansion Resources																							
	Wind, WW, 29	-	-	-	-	-	-	-	-	-	-	-	-	-	-	-	-	-	213	-	-	-	213	
	Wind, YK, 29	-	-	-	-	-	-	45	-	-	-	-	-	-	-	-	-	225	130	-	-	45	400	
	Total Wind	-	-	-	-	-	-	45	-	-	-	-	-	-	-	-	-	225	343	-	-	45	613	
	Utility Solar - PV - West	-	-	-	-	-	405	-	-	-	-	-	-	-	-	-	-	-	-	-	-	405	405	
Oregon Solar Capacity Standard	-	7	-	-	-	-	-	-	-	-	-	-	-	-	-	-	-	-	-	-	7	7		
DSM, Class 1, OR-Curtail	-	-	-	-	-	-	-	-	10.6	-	-	10.6	-	-	-	-	10.6	-	-	-	10.6	31.8		
DSM, Class 1, OR-Irrigate	-	-	-	-	-	-	-	5.0	-	-	-	-	-	-	-	3.4	-	-	-	-	5.0	8.4		
DSM, Class 1 Total	-	-	-	-	-	-	-	5.0	10.6	-	-	10.6	-	-	-	3.4	10.6	-	-	-	15.6	40.2		
DSM, Class 2, CA	1	2	3	3	4	3	3	3	3	3	3	3	3	3	3	2	2	2	2	2	28	51		
DSM, Class 2, OR	44	39	60	58	51	49	45	44	41	39	37	37	37	37	35	33	33	30	30	469	809			
DSM, Class 2, WA	8	9	20	19	19	17	17	18	18	14	14	14	14	14	13	11	11	10	10	10	164	285		
DSM, Class 2 Total	54	49	83	80	74	68	65	64	63	61	54	53	53	53	50	46	45	45	42	42	661	1,145		
FOT COB Q3	-	93	100	19	136	-	-	-	-	152	153	137	155	254	80	268	161	-	-	-	50	85		
FOT MidColumbia Q3	400	400	400	400	400	400	400	400	400	400	400	400	400	400	400	400	400	400	400	400	400	400		
FOT MidColumbia Q3 - 2	227	375	375	375	375	310	42	338	273	375	375	375	375	375	375	375	375	357	375	95	307	326		
FOT NOB Q3	100	100	100	100	100	100	100	100	100	100	100	100	100	100	100	100	100	100	100	100	100	100		
Existing Plant Retirements/Conversions	(222)	-	-	57	(106)	-	-	(450)	-	(354)	-	-	-	(326)	-	(694)	(77)	-	(1,316)	-				
Annual Additions, Long Term Resources	132	146	226	221	229	791	253	223	230	218	186	210	201	516	196	829	529	576	1,440	805				
Annual Additions, Short Term Resources	727	968	975	894	1,011	810	542	838	773	1,027	1,072	1,056	1,074	1,173	999	1,216	1,080	857	904	595				
Total Annual Additions	859	1,115	1,200	1,115	1,240	1,601	795	1,061	1,004	1,246	1,257	1,266	1,276	1,689	1,195	2,045	1,609	1,432	2,344	1,401				

1/ Front office transaction amounts reflect one-year transaction periods, are not additive, and are reported as a 10/20-year annual average.

Case C07-2		Capacity (MW)																			Resource Totals 1/		
		2015	2016	2017	2018	2019	2020	2021	2022	2023	2024	2025	2026	2027	2028	2029	2030	2031	2032	2033	2034	10-year	20-year
East	Existing Plant Retirements/Conversions																						
	Hayden 1	-	-	-	-	-	-	-	-	-	-	-	-	-	-	-	-	(45)	-	-	-	-	(45)
	Hayden 2	-	-	-	-	-	-	-	-	-	-	-	-	-	-	-	-	(33)	-	-	-	-	(33)
	Hunter 2 (Coal Early Retirement/Conversions)	-	-	-	-	-	-	-	-	-	-	(269)	-	-	-	-	-	-	-	-	-	-	(269)
	Huntington 1 (Coal Early Retirement/Conversions)	-	-	-	-	-	-	-	-	-	-	(459)	-	-	-	-	-	-	-	-	-	-	(459)
	Huntington 2 (Coal Early Retirement/Conversions)	-	-	-	-	-	-	-	(450)	-	-	-	-	-	-	-	-	-	-	-	-	(450)	(450)
	Carbon 1 (Coal Early Retirement/Conversions)	(67)	-	-	-	-	-	-	-	-	-	-	-	-	-	-	-	-	-	-	-	(67)	(67)
	Carbon 2 (Coal Early Retirement/Conversions)	(105)	-	-	-	-	-	-	-	-	-	-	-	-	-	-	-	-	-	-	-	(105)	(105)
	Cholla 4 (Coal Early Retirement/Conversions)	-	-	-	-	-	-	-	-	-	-	(387)	-	-	-	-	-	-	-	-	-	-	(387)
	DaveJohnston 1 (Coal Early Retirement/Conversions)	-	-	-	-	(106)	-	-	-	-	-	-	-	-	-	-	-	-	-	-	-	(106)	(106)
	DaveJohnston 2 (Coal Early Retirement/Conversions)	-	-	-	-	-	-	-	-	-	(106)	-	-	-	-	-	-	-	-	-	-	(106)	(106)
	DaveJohnston 3	-	-	-	-	-	-	-	-	-	-	-	-	-	(220)	-	-	-	-	-	-	-	(220)
	DaveJohnston 4	-	-	-	-	-	-	-	-	-	-	-	-	-	-	-	-	-	(330)	-	-	-	(330)
	Naughton 1	-	-	-	-	-	-	-	-	-	-	-	-	-	-	-	(156)	-	-	-	-	-	(156)
	Naughton 2	-	-	-	-	-	-	-	-	-	-	-	-	-	-	-	(201)	-	-	-	-	-	(201)
	Naughton 3 (Coal Early Retirement/Conversions)	(50)	-	-	(280)	-	-	-	-	-	-	-	-	-	-	-	-	-	-	-	-	(330)	(330)
	Wyodak (Coal Early Retirement/Conversions)	-	-	-	-	-	-	-	-	-	-	-	-	-	-	-	-	-	(268)	-	-	-	(268)
	Gadsby 1-6	-	-	-	-	-	-	-	-	-	-	-	-	-	-	-	-	-	(358)	-	-	-	(358)
	Coal Ret_AZ - Gas RePower	-	-	-	-	-	-	-	-	-	-	387	-	-	-	-	-	-	-	-	-	-	387
	Coal Ret_WY - Gas RePower	-	-	-	337	-	-	-	-	-	-	-	-	-	-	-	(337)	-	-	-	-	337	-
	Expansion Resources																						
	CCCT - DJohns - F 1xl	-	-	-	-	-	-	-	-	-	-	-	-	-	-	-	-	-	-	313	-	-	313
	CCCT - DJohns - J 1xl	-	-	-	-	-	-	-	-	-	-	-	-	-	-	-	-	-	-	423	-	-	423
	CCCT - Huntington - J 1xl	-	-	-	-	-	-	-	-	-	-	846	-	-	-	-	-	-	-	-	-	-	846
	CCCT - Naughton - J 1xl	-	-	-	-	-	-	-	-	-	-	-	-	-	-	-	-	401	-	-	-	-	401
	CCCT - Utah-N - F 2xl	-	-	-	-	-	-	-	-	-	-	-	-	-	-	-	-	-	-	635	-	-	635
	CCCT - Utah-S - J 1xl	-	-	-	-	-	-	-	-	-	-	-	-	-	423	-	423	-	-	-	-	-	846
	Total CCCT	-	-	-	-	-	-	-	-	-	-	846	-	-	423	-	824	-	-	1,371	-	-	3,464
	Wind_DJohnston_43	-	-	-	-	-	25	-	-	-	-	-	-	-	-	-	-	-	-	-	-	25	25
	Total Wind	-	-	-	-	-	25	-	-	-	-	-	-	-	-	-	-	-	-	-	-	25	25
	Utility Solar - PV - East	-	-	-	-	-	154	-	-	-	-	-	-	-	-	-	-	-	-	-	-	154	154
	DSM_Class 2_ID	4	4	10	10	10	9	9	9	9	8	8	7	7	7	6	6	6	6	6	6	82	149
	DSM_Class 2_UT	69	78	115	112	122	109	112	122	124	123	105	119	121	121	118	105	104	102	102	101	1,083	2,180
	DSM_Class 2_WY	6	8	18	21	23	21	22	23	24	25	20	20	20	21	21	20	21	21	21	22	192	399
	DSM_Class 2 Total	79	90	142	142	154	138	143	154	157	157	132	147	148	149	146	131	131	130	129	129	1,357	2,729
	FOT Mona Q3	-	-	-	-	-	-	-	-	-	-	74	75	44	44	44	44	28	75	-	139	-	28
	West																						
Existing Plant Retirements/Conversions																							
JimBridger 1 (Coal Early Retirement/Conversions)	-	-	-	-	-	-	-	-	-	-	(354)	-	-	-	-	-	-	-	-	-	(354)	(354)	
JimBridger 2 (Coal Early Retirement/Conversions)	-	-	-	-	-	-	-	-	-	-	-	-	-	-	-	(359)	-	-	-	-	-	(359)	
Expansion Resources																							
Wind_YK_29	-	-	-	-	-	-	91	-	-	-	-	-	-	-	-	-	14	78	-	-	91	183	
Total Wind	-	-	-	-	-	-	91	-	-	-	-	-	-	-	-	-	14	78	-	-	91	183	
Utility Solar - PV - West	-	-	-	-	-	405	-	-	-	-	-	-	-	-	-	-	-	-	-	-	405	405	
Oregon Solar Capacity Standard	-	7	-	-	-	-	-	-	-	-	-	-	-	-	-	-	-	-	-	-	7	7	
DSM_Class 1_OR-Curtail	-	-	-	-	-	-	-	-	-	21.2	-	-	-	-	-	-	10.6	-	-	-	21.2	31.8	
DSM_Class 1_OR-Irrigate	-	-	-	-	-	-	-	5.0	3.4	-	-	-	-	-	-	-	-	-	-	-	8.4	8.4	
DSM_Class 1 Total	-	-	-	-	-	-	-	5.0	3.4	21.2	-	-	-	-	-	-	10.6	-	-	-	29.6	40.2	
DSM_Class 2_CA	1	2	3	3	4	3	3	3	3	3	3	3	3	3	2	2	2	2	2	2	28	51	
DSM_Class 2_OR	44	39	60	58	50	48	45	44	41	39	37	37	36	37	35	33	33	33	30	30	469	809	
DSM_Class 2_WA	8	9	20	19	19	17	17	18	18	14	14	14	14	13	11	11	11	10	10	10	164	285	
DSM_Class 2 Total	54	49	83	80	73	68	65	64	63	61	54	53	53	53	51	46	45	45	42	42	661	1,145	
FOT COB Q3	-	93	100	18	136	-	-	-	-	227	145	138	188	97	262	183	126	206	-	-	57	96	
FOT MidColumbia Q3	400	400	400	400	400	400	400	400	400	400	400	400	400	400	400	400	400	400	400	400	400	400	
FOT MidColumbia Q3 - 2	227	375	375	375	375	310	31	327	269	375	375	375	375	375	375	375	375	375	375	375	304	333	
FOT NOB Q3	100	100	100	100	100	100	100	100	100	100	100	100	100	100	100	100	100	100	100	100	100	100	
Existing Plant Retirements/Conversions	(222)	-	-	57	(106)	-	-	(450)	-	(460)	(728)	-	-	(220)	(359)	(694)	(77)	-	(956)	-	-	-	
Annual Additions, Long Term Resources	133	146	226	222	228	791	299	223	223	240	1,031	200	201	625	196	1,015	265	175	1,543	170	-	-	
Annual Additions, Short Term Resources	727	968	975	893	1,011	810	531	827	769	1,102	1,094	1,088	1,107	1,016	1,181	1,102	1,029	1,156	737	1,014	-	-	
Total Annual Additions	859	1,115	1,200	1,116	1,239	1,600	830	1,050	992	1,342	2,125	1,288	1,308	1,642	1,377	2,117	1,294	1,331	2,280	1,185	-	-	

1/ Front office transaction amounts reflect one-year transaction periods, are not additive, and are reported as a 10/20-year annual average.

Case C09-1		Capacity (MW)																			Resource Totals 1/			
		2015	2016	2017	2018	2019	2020	2021	2022	2023	2024	2025	2026	2027	2028	2029	2030	2031	2032	2033	2034	10-year	20-year	
East	Existing Plant Retirements/Conversions																							
	Hayden 1	-	-	-	-	-	-	-	-	-	-	-	-	-	-	-	-	(45)	-	-	-	-	(45)	
	Hayden 2	-	-	-	-	-	-	-	-	-	-	-	-	-	-	-	-	(33)	-	-	-	-	(33)	
	Hunter 2 (Coal Early Retirement/Conversions)	-	-	-	-	-	-	-	-	-	-	-	-	-	-	-	-	-	-	(269)	-	-	(269)	
	Huntington 2 (Coal Early Retirement/Conversions)	-	-	-	-	-	-	-	(450)	-	-	-	-	-	-	-	-	-	-	-	-	-	(450)	(450)
	Carbon 1 (Coal Early Retirement/Conversions)	(67)	-	-	-	-	-	-	-	-	-	-	-	-	-	-	-	-	-	-	-	-	(67)	(67)
	Carbon 2 (Coal Early Retirement/Conversions)	(105)	-	-	-	-	-	-	-	-	-	-	-	-	-	-	-	-	-	-	-	-	(105)	(105)
	Cholla 4 (Coal Early Retirement/Conversions)	-	-	-	-	-	-	-	-	-	-	(387)	-	-	-	-	-	-	-	-	-	-	-	(387)
	DaveJohnston 1 (Coal Early Retirement/Conversions)	-	-	-	-	(106)	-	-	-	-	-	-	-	-	-	-	-	-	-	-	-	-	(106)	(106)
	DaveJohnston 2	-	-	-	-	-	-	-	-	-	-	-	-	-	(106)	-	-	-	-	-	-	-	-	(106)
	DaveJohnston 3	-	-	-	-	-	-	-	-	-	-	-	-	-	(220)	-	-	-	-	-	-	-	-	(220)
	DaveJohnston 4	-	-	-	-	-	-	-	-	-	-	-	-	-	-	-	-	-	(330)	-	-	-	-	(330)
	Naughton 1	-	-	-	-	-	-	-	-	-	-	-	-	-	-	-	(156)	-	-	-	-	-	-	(156)
	Naughton 2	-	-	-	-	-	-	-	-	-	-	-	-	-	-	-	(201)	-	-	-	-	-	-	(201)
	Naughton 3 (Coal Early Retirement/Conversions)	(50)	-	-	(280)	-	-	-	-	-	-	-	-	-	-	-	-	-	-	-	-	-	(330)	(330)
	Gadsby 1-6	-	-	-	-	-	-	-	-	-	-	-	-	-	-	-	-	-	(358)	-	-	-	-	(358)
	Coal Ret_AZ - Gas RePower	-	-	-	-	-	-	-	-	-	-	387	-	-	-	-	-	-	-	-	-	-	-	387
	Coal Ret_WY - Gas RePower	-	-	-	337	-	-	-	-	-	-	-	-	-	-	-	(337)	-	-	-	-	-	-	337
	Expansion Resources																							
	CCCT - DJohns - F 1x1	-	-	-	-	-	-	-	-	-	-	-	-	-	-	313	-	-	-	-	-	-	-	313
	CCCT - DJohns - J 1x1	-	-	-	-	-	-	-	-	-	-	-	-	-	-	-	-	-	-	423	-	-	-	423
	CCCT - Huntington - J 1x1	-	-	-	-	-	-	-	-	423	-	-	-	-	-	-	-	-	-	-	-	-	-	423
	CCCT - Naughton - J 1x1	-	-	-	-	-	-	-	-	-	-	-	-	-	-	-	401	-	-	-	-	-	-	401
	CCCT - Utah-N - F 2x1	-	-	-	-	-	-	-	-	-	-	-	-	-	-	-	-	-	635	-	-	-	-	635
	CCCT - Utah-N - J 1x1	-	-	-	-	-	-	-	-	-	-	-	-	-	-	-	-	-	-	-	423	-	-	423
	CCCT - Utah-S - J 1x1	-	-	-	-	-	-	-	423	-	-	-	-	-	-	-	-	423	-	-	-	-	-	423
	Total CCCT	-	-	-	-	-	-	423	423	-	-	-	-	-	313	-	824	-	-	1,058	423	-	846	3,464
	Wind, DJohnston, 43	-	-	-	-	-	25	-	-	-	-	-	-	-	-	-	-	-	-	1	-	-	25	26
	Total Wind	-	-	-	-	-	25	-	-	-	-	-	-	-	-	-	-	-	-	1	-	-	25	26
	Utility Solar - PV - East	-	-	-	-	-	154	-	-	-	-	-	-	-	-	-	-	-	-	-	-	-	154	154
	DSM, Class 1, ID-Irrigate	-	-	-	-	3.5	-	-	-	-	-	-	-	-	-	-	-	-	-	21.1	-	-	3.5	24.6
	DSM, Class 1, UT-DLC-RES	-	-	-	-	-	-	-	-	-	-	-	-	-	-	-	-	-	-	4.9	-	-	4.9	4.9
	DSM, Class 1, UT-Irrigate	-	-	-	-	10.1	-	-	-	-	-	-	-	-	-	-	-	-	-	6.4	-	-	10.1	16.5
	DSM, Class 1 Total	-	-	-	-	13.5	-	-	-	-	-	-	-	-	-	-	-	-	-	32.4	-	-	13.5	46.0
	DSM, Class 2, ID	4	6	6	6	7	4	4	4	5	5	5	5	5	5	5	4	4	5	5	4	5	51	98
DSM, Class 2, UT	83	93	100	102	110	85	86	90	93	97	81	81	84	84	81	75	75	75	74	73	938	1,719		
DSM, Class 2, WY	7	9	10	13	15	12	13	14	15	16	13	13	14	15	15	15	16	16	17	17	125	276		
DSM, Class 2 Total	94	107	116	120	132	101	103	108	113	118	99	99	103	104	100	95	95	96	95	94	1,114	2,094		
West																								
Existing Plant Retirements/Conversions																								
JimBridger 1 (Coal Early Retirement/Conversions)	-	-	-	-	-	-	-	-	-	(354)	-	-	-	-	-	-	-	-	-	-	-	(354)	(354)	
JimBridger 2 (Coal Early Retirement/Conversions)	-	-	-	-	-	-	-	-	-	-	-	-	-	-	-	-	-	-	(359)	-	-	-	(359)	
Expansion Resources																								
Wind, YK, 29	-	-	-	-	-	-	-	21	-	-	-	-	-	-	-	-	-	-	-	-	-	21	21	
Total Wind	-	-	-	-	-	-	-	21	-	-	-	-	-	-	-	-	-	-	-	-	-	21	21	
Utility Solar - PV - West	-	-	-	-	-	-	-	-	-	-	-	-	-	-	-	-	-	-	421	-	-	-	421	
Oregon Solar Capacity Standard	-	7	-	-	-	-	-	-	-	-	-	-	-	-	-	-	-	-	-	-	-	7	7	
DSM, Class 1, OR-Curtail	-	-	-	-	21.2	-	-	-	-	-	-	-	-	-	-	-	10.6	-	-	-	-	21.2	31.8	
DSM, Class 1, OR-Irrigate	-	-	-	-	5.0	-	-	-	-	-	-	-	-	-	-	-	3.4	-	-	-	-	5.0	8.4	
DSM, Class 1 Total	-	-	-	-	26.2	-	-	-	-	-	-	-	-	-	-	3.4	10.6	-	-	-	-	26.2	40.2	
DSM, Class 2, CA	2	2	2	2	2	1	1	2	2	2	1	1	1	1	1	1	1	1	1	1	1	18	31	
DSM, Class 2, OR	44	40	37	34	31	27	25	25	24	23	22	22	22	22	21	21	21	21	21	20	309	520		
DSM, Class 2, WA	9	10	11	10	11	9	10	10	11	11	9	9	9	9	9	8	8	8	8	7	102	186		
DSM, Class 2 Total	55	52	50	47	45	38	36	36	36	35	32	32	32	32	31	30	30	30	30	28	428	737		
FOT COB Q3	-	67	108	58	265	245	-	4	-	-	42	105	248	117	73	54	214	268	208	75	104	104		
FOT MidColumbia Q3	400	400	400	400	400	400	400	400	400	400	400	400	400	400	400	400	400	400	400	400	400	400	400	
FOT MidColumbia Q3 - 2	214	375	375	375	375	375	338	375	340	334	375	375	375	375	375	375	375	375	375	375	375	375	361	
FOT NOB Q3	100	100	100	100	-	-	-	-	-	-	-	-	-	-	-	-	-	-	-	-	-	40	20	
Existing Plant Retirements/Conversions	(222)	-	-	57	(106)	-	-	(450)	-	(354)	-	-	-	(326)	-	(694)	(77)	-	(1,316)	-	-	-	-	
Annual Additions, Long Term Resources	149	166	165	167	216	318	139	588	572	153	130	131	136	449	132	952	136	126	1,638	545	-	-		
Annual Additions, Short Term Resources	714	942	983	933	1,040	1,020	738	779	740	734	775	817	880	1,023	892	848	829	989	1,043	983	-	-		
Total Annual Additions	863	1,107	1,149	1,100	1,257	1,338	877	1,367	1,312	888	905	948	1,015	1,472	1,024	1,801	965	1,115	2,680	1,528	-	-		

1/ Front office transaction amounts reflect one-year transaction periods, are not additive, and are reported as a 10/20-year annual average.

Case C09-2		Capacity (MW)																				Resource Totals 1/	
		2015	2016	2017	2018	2019	2020	2021	2022	2023	2024	2025	2026	2027	2028	2029	2030	2031	2032	2033	2034	10-year	20-year
East	Existing Plant Retirements/Conversions																						
	Hayden 1	-	-	-	-	-	-	-	-	-	-	-	-	-	-	-	-	-	-	-	(45)	-	(45)
	Hayden 2	-	-	-	-	-	-	-	-	-	-	-	-	-	-	-	-	-	-	-	(33)	-	(33)
	Hunter 2 (Coal Early Retirement/Conversions)	-	-	-	-	-	-	-	-	-	-	-	-	-	-	-	-	-	-	-	-	-	(269)
	Huntington 1 (Coal Early Retirement/Conversions)	-	-	-	-	-	-	-	-	-	-	-	-	-	-	-	-	-	-	-	-	-	(459)
	Huntington 2 (Coal Early Retirement/Conversions)	-	-	-	-	-	-	-	-	-	-	-	-	-	-	-	-	-	-	-	-	(450)	(450)
	Carbon 1 (Coal Early Retirement/Conversions)	(67)	-	-	-	-	-	-	-	-	-	-	-	-	-	-	-	-	-	-	-	-	(67)
	Carbon 2 (Coal Early Retirement/Conversions)	(105)	-	-	-	-	-	-	-	-	-	-	-	-	-	-	-	-	-	-	-	-	(105)
	Cholla 4 (Coal Early Retirement/Conversions)	-	-	-	-	-	-	-	-	-	-	-	-	-	-	-	-	-	-	-	-	(387)	(387)
	DaveJohnston 1 (Coal Early Retirement/Conversions)	-	-	-	-	(106)	-	-	-	-	-	-	-	-	-	-	-	-	-	-	-	-	(106)
	DaveJohnston 2 (Coal Early Retirement/Conversions)	-	-	-	-	-	-	-	-	-	-	(106)	-	-	-	-	-	-	-	-	-	-	(106)
	DaveJohnston 3	-	-	-	-	-	-	-	-	-	-	-	-	-	-	-	-	-	-	-	(220)	-	(220)
	DaveJohnston 4	-	-	-	-	-	-	-	-	-	-	-	-	-	-	-	-	-	-	-	(330)	-	(330)
	Naughton 1	-	-	-	-	-	-	-	-	-	-	-	-	-	-	-	-	-	-	-	(156)	-	(156)
	Naughton 2	-	-	-	-	-	-	-	-	-	-	-	-	-	-	-	-	-	-	-	(201)	-	(201)
	Naughton 3 (Coal Early Retirement/Conversions)	(50)	-	-	(280)	-	-	-	-	-	-	-	-	-	-	-	-	-	-	-	-	-	(330)
	Wyodak (Coal Early Retirement/Conversions)	-	-	-	-	-	-	-	-	-	-	-	-	-	-	-	-	-	-	-	(268)	-	(268)
	Cadby 1-6	-	-	-	-	-	-	-	-	-	-	-	-	-	-	-	-	-	-	-	(358)	-	(358)
	Coal Ret_AZ - Gas RePower	-	-	-	-	-	-	-	-	-	-	-	387	-	-	-	-	-	-	-	-	-	387
	Coal Ret_WY - Gas RePower	-	-	-	337	-	-	-	-	-	-	-	-	-	-	-	-	-	-	-	(337)	-	337
	Expansion Resources																						
	CCCT - DJohns - F 1x1	-	-	-	-	-	-	-	-	-	-	-	-	-	-	-	-	-	-	-	313	-	313
	CCCT - DJohns - J 1x1	-	-	-	-	-	-	-	-	-	-	-	-	-	-	-	-	-	-	-	423	-	423
	CCCT - Huntingn - J 1x1	-	-	-	-	-	-	-	-	423	-	-	423	-	-	-	-	-	-	-	-	-	423
	CCCT - Naughton - J 1x1	-	-	-	-	-	-	-	-	-	-	-	-	-	-	-	-	-	-	-	401	-	401
	CCCT - Utah-N - F 2x1	-	-	-	-	-	-	-	-	-	-	-	-	-	635	-	-	635	-	-	-	-	1,270
	CCCT - Utah-S - J 1x1	-	-	-	-	-	-	-	-	-	423	423	-	-	-	-	-	-	-	-	-	-	423
	Total CCCT	-	-	-	-	-	-	-	423	-	423	846	-	-	635	-	635	-	-	1,137	-	846	
Wind, DJohnston, 43	-	-	-	-	-	25	-	-	-	-	-	-	-	-	-	-	-	-	-	1	25	26	
Total Wind	-	-	-	-	-	25	-	-	-	-	-	-	-	-	-	-	-	-	-	1	25	26	
Utility Solar - PV - East	-	-	-	-	-	144	-	-	-	-	-	-	-	-	-	-	-	-	1	-	9		
DSM, Class 1, ID-Irrigate	-	-	-	-	3.5	-	-	-	-	-	-	-	-	-	-	-	-	-	11.2	-	3.5		
DSM, Class 1, UT-DLC-RES	-	-	-	-	-	-	-	-	-	-	-	-	-	-	-	-	-	-	-	-	10.0		
DSM, Class 1, UT-Irrigate	-	-	-	-	10.1	-	-	-	-	-	-	-	-	-	-	-	-	-	6.4	-	2.5		
DSM, Class 1 Total	-	-	-	-	13.5	-	-	-	-	-	-	-	-	-	-	-	-	-	17.6	-	23.8		
DSM, Class 2, ID	4	6	6	6	7	4	4	4	5	5	5	5	5	5	5	4	4	5	5	4	51		
DSM, Class 2, UT	83	93	100	102	110	85	86	90	91	93	79	81	84	84	81	76	76	76	73	76	931		
DSM, Class 2, WY	7	9	10	13	15	12	13	14	15	16	13	13	14	15	16	16	17	17	17	17	124		
DSM, Class 2 Total	94	107	116	120	132	101	103	108	110	114	97	99	103	104	101	96	96	97	94	98	1,106		
2,091																							
West	Existing Plant Retirements/Conversions																						
	JimBridger 1 (Coal Early Retirement/Conversions)	-	-	-	-	-	-	-	-	-	(354)	-	-	-	-	-	-	-	-	-	-	(354)	
	JimBridger 2 (Coal Early Retirement/Conversions)	-	-	-	-	-	-	-	-	-	-	-	-	-	-	-	-	-	-	-	(359)	(359)	
	Expansion Resources																						
	Wind, YK, 29	-	-	-	-	-	-	-	-	-	39	-	-	-	-	-	-	-	-	-	-	39	
	Total Wind	-	-	-	-	-	-	-	-	-	39	-	-	-	-	-	-	-	-	-	-	39	
	Utility Solar - PV - West	-	-	-	-	-	-	-	-	-	-	-	-	-	-	-	-	-	-	124	-	384	
	Oregon Solar Capacity Standard	-	7	-	-	-	-	-	-	-	-	-	-	-	-	-	-	-	-	-	-	7	
	DSM, Class 1, OR-Curtail	-	-	-	-	21.2	-	-	-	-	-	-	-	-	-	-	-	-	-	10.6	-	21.2	
	DSM, Class 1, OR-Irrigate	-	-	-	-	5.0	-	-	-	-	-	-	-	-	-	-	-	-	-	3.4	-	5.0	
	DSM, Class 1 Total	-	-	-	-	26.2	-	-	-	-	-	-	-	-	-	-	-	-	-	3.4	-	26.2	
	DSM, Class 2, CA	1	2	2	2	2	1	1	2	2	2	1	1	1	1	1	1	1	1	1	1	17	
	DSM, Class 2, OR	44	40	37	34	31	27	25	25	24	23	22	22	22	22	22	21	21	23	20	21	309	
	DSM, Class 2, WA	9	10	11	10	11	9	10	10	11	11	9	9	9	9	8	8	8	8	8	8	102	
	DSM, Class 2 Total	55	52	50	47	45	38	36	36	35	32	32	32	33	32	30	30	32	28	30	30	428	
	FOT COB Q3	-	67	108	58	266	249	-	13	7	27	54	95	158	8	216	247	234	268	118	268	79	
	FOT MidColumbia Q3	400	400	400	400	400	400	400	400	400	400	400	400	400	400	400	400	400	400	400	400	400	
	FOT MidColumbia Q3 - 2	214	375	375	375	375	375	375	375	375	375	375	375	375	375	375	375	375	375	375	375	355	
	FOT NOB Q3	100	100	100	100	-	-	-	-	-	-	-	-	-	-	-	-	-	-	-	-	40	
	20																						
	Existing Plant Retirements/Conversions	(222)	-	-	57	(106)	-	-	(450)	-	(460)	(728)	-	-	(220)	(359)	(694)	(77)	-	(956)	-	-	
	Annual Additions, Long Term Resources	149	166	165	167	216	308	139	567	146	612	975	131	136	772	134	765	137	272	1,260	546	-	
	Annual Additions, Short Term Resources	714	942	983	933	1,041	1,024	738	788	782	802	829	870	933	783	991	1,022	1,009	1,043	893	1,043	-	
Total Annual Additions	863	1,107	1,149	1,100	1,257	1,332	877	1,356	928	1,413	1,804	1,001	1,069	1,555	1,125	1,786	1,146	1,315	2,153	1,588	-		

1/ Front office transaction amounts reflect one-year transaction periods, are not additive, and are reported as a 10/20-year annual average.

Case C11-1		Capacity (MW)																			Resource Totals 1/		
		2015	2016	2017	2018	2019	2020	2021	2022	2023	2024	2025	2026	2027	2028	2029	2030	2031	2032	2033	2034	10-year	20-year
East	Existing Plant Retirements/Conversions																						
	Hayden 1	-	-	-	-	-	-	-	-	-	-	-	-	-	-	-	-	(45)	-	-	-	-	(45)
	Hayden 2	-	-	-	-	-	-	-	-	-	-	-	-	-	-	-	-	(33)	-	-	-	-	(33)
	Hunter 2 (Coal Early Retirement/Conversions)	-	-	-	-	-	-	-	-	-	-	-	-	-	-	-	-	-	-	(269)	-	-	(269)
	Huntington 2 (Coal Early Retirement/Conversions)	-	-	-	-	-	-	-	-	(450)	-	-	-	-	-	-	-	-	-	-	-	(450)	(450)
	Carbon 1 (Coal Early Retirement/Conversions)	(67)	-	-	-	-	-	-	-	-	-	-	-	-	-	-	-	-	-	-	-	(67)	(67)
	Carbon 2 (Coal Early Retirement/Conversions)	(105)	-	-	-	-	-	-	-	-	-	-	-	-	-	-	-	-	-	-	-	(105)	(105)
	Cholla 4 (Coal Early Retirement/Conversions)	-	-	-	-	-	-	-	-	-	-	(387)	-	-	-	-	-	-	-	-	-	(387)	(387)
	DaveJohnston 1 (Coal Early Retirement/Conversions)	-	-	-	-	(106)	-	-	-	-	-	-	-	-	-	-	-	-	-	-	-	(106)	(106)
	DaveJohnston 2	-	-	-	-	-	-	-	-	-	-	-	-	-	(106)	-	-	-	-	-	-	(106)	(106)
	DaveJohnston 3	-	-	-	-	-	-	-	-	-	-	-	-	-	(220)	-	-	-	-	-	-	(220)	(220)
	DaveJohnston 4	-	-	-	-	-	-	-	-	-	-	-	-	-	-	-	-	-	(330)	-	-	(330)	(330)
	Naughton 1	-	-	-	-	-	-	-	-	-	-	-	-	-	-	-	(156)	-	-	-	-	(156)	(156)
	Naughton 2	-	-	-	-	-	-	-	-	-	-	-	-	-	-	-	(201)	-	-	-	-	(201)	(201)
	Naughton 3 (Coal Early Retirement/Conversions)	(50)	-	-	(280)	-	-	-	-	-	-	-	-	-	-	-	-	-	-	-	-	(330)	(330)
	Cadby 1-6	-	-	-	-	-	-	-	-	-	-	-	-	-	-	-	-	-	-	(358)	-	(358)	(358)
	Coal Ret. AZ - Gas RePower	-	-	-	-	-	-	-	-	-	-	387	-	-	-	-	-	-	-	-	-	387	387
	Coal Ret. WY - Gas RePower	-	-	-	337	-	-	-	-	-	-	-	-	-	-	-	(337)	-	-	-	-	337	-
	Expansion Resources																						
	CCCT - DJohns - F 1xl	-	-	-	-	-	-	-	-	-	-	-	-	-	313	-	-	-	-	-	-	-	313
	CCCT - DJohns - J 1xl	-	-	-	-	-	-	-	-	-	-	-	-	-	-	-	-	-	423	-	-	423	423
	CCCT - Huntington - J 1xl	-	-	-	-	-	-	-	-	-	-	-	-	-	-	-	423	-	-	-	-	423	423
	CCCT - Naughton - J 1xl	-	-	-	-	-	-	-	-	-	-	-	-	-	-	-	-	401	-	-	-	401	401
	CCCT - Utah-N - F 2xl	-	-	-	-	-	-	-	-	-	-	-	-	-	-	-	-	-	-	635	635	-	1,270
	CCCT - Utah-S - J 1xl	-	-	-	-	-	-	-	-	-	423	-	-	-	423	-	-	-	-	-	-	423	846
	Total CCCT	-	-	-	-	-	-	-	-	-	423	-	-	-	736	-	423	-	401	1,058	635	423	3,676
	Wind, DJohnston, 43	-	-	-	-	-	25	-	-	-	-	-	-	-	-	-	-	-	-	-	-	25	25
	Total Wind	-	-	-	-	-	25	-	-	-	-	-	-	-	-	-	-	-	-	-	-	25	25
	Utility Solar - PV - East	-	-	-	-	-	154	-	-	-	-	-	-	-	-	-	-	-	-	-	-	154	154
	DSM, Class 1, UT-DLC-RES	-	-	-	-	-	-	-	-	-	-	-	-	-	-	-	-	-	-	4.9	-	-	4.9
	DSM, Class 1 Total	-	-	-	-	-	-	-	-	-	-	-	-	-	-	-	-	-	-	4.9	-	-	4.9
	DSM, Class 2, ID	4	4	5	5	5	4	4	5	5	5	4	4	5	5	5	4	4	4	4	3	46	87
	DSM, Class 2, UT	69	81	87	91	102	89	89	91	89	87	74	75	80	79	77	71	69	67	65	57	875	1,587
	DSM, Class 2, WY	6	10	11	13	15	13	14	15	15	16	13	13	13	14	14	14	15	15	13	128	268	268
	DSM, Class 2 Total	79	95	103	109	122	106	108	110	109	107	91	92	98	98	95	89	87	86	84	74	1,049	1,942
	FOT Mona Q3	-	-	-	-	-	-	-	52	32	-	53	94	168	44	44	146	152	75	282	75	8	61
	Existing Plant Retirements/Conversions																						
	JimBridger 1 (Coal Early Retirement/Conversions)	-	-	-	-	-	-	-	-	-	(354)	-	-	-	-	-	-	-	-	-	-	(354)	(354)
	JimBridger 2 (Coal Early Retirement/Conversions)	-	-	-	-	-	-	-	-	-	-	-	-	-	-	-	-	-	(359)	-	-	-	(359)
	Expansion Resources																						
	Wind, YK, 29	-	-	-	-	-	-	-	-	-	4	-	-	-	-	-	-	-	-	-	-	4	4
	Total Wind	-	-	-	-	-	-	-	-	-	4	-	-	-	-	-	-	-	-	-	-	4	4
Oregon Solar Capacity Standard	-	7	-	-	-	-	-	-	-	-	-	-	-	-	-	-	-	-	-	-	7	7	
DSM, Class 1, OR-Curtail	-	-	-	-	-	-	-	-	10.6	-	-	10.6	-	-	10.6	-	-	-	-	-	10.6	31.8	
DSM, Class 1, OR-Irrigate	-	-	-	-	-	-	-	-	5.0	-	-	-	-	-	-	-	-	-	-	-	5.0	5.0	
DSM, Class 1 Total	-	-	-	-	-	-	-	-	5.0	10.6	-	-	10.6	-	-	10.6	-	-	-	-	15.6	36.8	
DSM, Class 2, CA	1	2	2	2	2	2	2	2	2	1	1	1	1	1	1	1	1	1	1	1	17	29	
DSM, Class 2, OR	44	40	39	39	38	37	35	32	31	28	17	16	14	14	12	11	10	10	10	361	483		
DSM, Class 2, WA	8	9	10	10	11	9	10	10	10	9	8	8	8	8	8	7	6	6	5	97	169	169	
DSM, Class 2 Total	54	51	51	51	52	48	46	43	42	39	26	25	23	23	21	19	18	18	17	16	475	682	
FOT COB Q3	-	87	134	88	237	207	-	268	268	231	268	268	268	177	48	268	268	171	208	163	152	181	
FOT MidColumbia Q3	400	400	400	400	400	400	400	400	400	400	400	400	400	400	400	400	400	400	400	400	400	400	
FOT MidColumbia Q3 - 2	227	375	375	375	375	375	248	375	375	375	375	375	375	375	375	375	375	375	375	375	348	361	
FOT NOB Q3	100	100	100	100	100	100	100	100	100	100	100	100	100	100	100	100	100	100	100	100	100	100	
Existing Plant Retirements/Conversions	(222)	-	-	57	(106)	-	-	(450)	-	(354)	-	-	-	(326)	-	(694)	(77)	-	(1,316)	-	-	-	
Annual Additions, Long Term Resources	132	153	154	160	174	333	154	158	161	573	117	128	121	857	127	531	105	504	1,164	725	-	-	
Annual Additions, Short Term Resources	727	962	1,009	963	1,112	1,082	748	1,195	1,175	1,106	1,196	1,237	1,311	1,096	967	1,289	1,295	1,121	1,366	1,113	-	-	
Total Annual Additions	859	1,114	1,163	1,123	1,286	1,414	902	1,353	1,336	1,679	1,313	1,365	1,432	1,953	1,093	1,820	1,400	1,625	2,530	1,838	-	-	

1/ Front office transaction amounts reflect one-year transaction periods, are not additive, and are reported as a 10/20-year annual average.

Case C11-2		Capacity (MW)																				Resource Totals 1/		
		2015	2016	2017	2018	2019	2020	2021	2022	2023	2024	2025	2026	2027	2028	2029	2030	2031	2032	2033	2034	10-year	20-year	
East	Existing Plant Retirements/Conversions																							
	Hayden 1	-	-	-	-	-	-	-	-	-	-	-	-	-	-	-	-	-	(45)	-	-	-	(45)	
	Hayden 2	-	-	-	-	-	-	-	-	-	-	-	-	-	-	-	-	-	(33)	-	-	-	(33)	
	Hunter 2 (Coal Early Retirement/Conversions)	-	-	-	-	-	-	-	-	-	-	-	(269)	-	-	-	-	-	-	-	-	-	(269)	
	Huntington 1 (Coal Early Retirement/Conversions)	-	-	-	-	-	-	-	-	-	-	(459)	-	-	-	-	-	-	-	-	-	-	(459)	
	Huntington 2 (Coal Early Retirement/Conversions)	-	-	-	-	-	-	-	(450)	-	-	-	-	-	-	-	-	-	-	-	-	-	(450)	
	Carbon 1 (Coal Early Retirement/Conversions)	(67)	-	-	-	-	-	-	-	-	-	-	-	-	-	-	-	-	-	-	-	-	(67)	
	Carbon 2 (Coal Early Retirement/Conversions)	(105)	-	-	-	-	-	-	-	-	-	-	-	-	-	-	-	-	-	-	-	-	(105)	
	Cholla 4 (Coal Early Retirement/Conversions)	-	-	-	-	-	-	-	-	-	-	(387)	-	-	-	-	-	-	-	-	-	-	(387)	
	DaveJohnston 1 (Coal Early Retirement/Conversions)	-	-	-	-	(106)	-	-	-	-	-	-	-	-	-	-	-	-	-	-	-	-	(106)	
	DaveJohnston 2 (Coal Early Retirement/Conversions)	-	-	-	-	-	-	-	-	-	(106)	-	-	-	-	-	-	-	-	-	-	-	(106)	
	DaveJohnston 3	-	-	-	-	-	-	-	-	-	-	-	-	-	(220)	-	-	-	-	-	-	-	(220)	
	DaveJohnston 4	-	-	-	-	-	-	-	-	-	-	-	-	-	-	-	-	-	(330)	-	-	-	(330)	
	Naughton 1	-	-	-	-	-	-	-	-	-	-	-	-	-	-	-	(156)	-	-	-	-	-	(156)	
	Naughton 2	-	-	-	-	-	-	-	-	-	-	-	-	-	-	-	(201)	-	-	-	-	-	(201)	
	Naughton 3 (Coal Early Retirement/Conversions)	(50)	-	-	(280)	-	-	-	-	-	-	-	-	-	-	-	-	-	-	-	-	(330)	(330)	
	Wyodak (Coal Early Retirement/Conversions)	-	-	-	-	-	-	-	-	-	-	-	-	-	-	-	-	-	(268)	-	-	-	(268)	
	Cadby 1-6	-	-	-	-	-	-	-	-	-	-	-	-	-	-	-	-	-	(358)	-	-	-	(358)	
	Coal Ret_AZ - Gas RePower	-	-	-	-	-	-	-	-	-	-	-	387	-	-	-	-	-	-	-	-	-	387	
	Coal Ret_WY - Gas RePower	-	-	-	337	-	-	-	-	-	-	-	-	-	-	-	(337)	-	-	-	-	-	337	
	Expansion Resources																							
	CCCT - DJohns - F 2xl	-	-	-	-	-	-	-	-	-	-	-	-	-	-	-	-	-	635	-	-	-	635	
	CCCT - Huntington - J 1xl	-	-	-	-	-	-	-	-	-	-	846	-	-	-	-	-	-	-	-	-	-	846	
	CCCT - Naughton - J 1xl	-	-	-	-	-	-	-	-	-	-	-	-	-	-	-	-	401	-	-	-	-	401	
	CCCT - Utah-N - F 2xl	-	-	-	-	-	-	-	-	-	-	-	-	-	-	635	-	-	635	-	-	-	1,270	
	CCCT - Utah-S - J 1xl	-	-	-	-	-	-	-	-	-	423	-	-	-	423	-	-	-	-	-	-	-	423	
	Total CCCT	-	-	-	-	-	-	-	-	-	423	846	-	-	423	635	401	-	-	1,270	-	-	423	3,998
	Wind, DJohnston, 43	-	-	-	-	-	106	-	-	-	21	-	-	-	-	-	-	-	-	-	-	-	127	
	Total Wind	-	-	-	-	-	106	-	-	-	21	-	-	-	-	-	-	-	-	-	-	-	127	
	Utility Solar - PV - East	-	-	-	-	-	-	-	-	-	34	-	-	-	-	-	-	-	-	-	26	-	34	
	DSM, Class 1, ID-Irrigate	-	-	-	-	-	-	-	-	-	-	-	-	-	-	-	-	-	11.2	-	6.0	-	17.1	
	DSM, Class 1, UT-DLC-RES	-	-	-	-	-	-	-	-	-	-	-	-	-	-	-	-	-	4.9	-	-	-	4.9	
	DSM, Class 1, UT-Irrigate	-	-	-	-	-	-	-	-	-	-	-	-	-	-	-	-	-	10.0	-	2.5	-	12.5	
	DSM, Class 1 Total	-	-	-	-	-	-	-	-	-	-	-	-	-	-	-	-	-	26.1	-	8.5	-	34.6	
	DSM, Class 2, ID	4	4	5	5	6	4	4	5	5	5	4	5	5	5	5	4	4	4	4	4	4	46	
	DSM, Class 2, UT	69	81	87	95	102	89	89	91	95	92	81	81	80	80	77	71	69	69	64	66	890	1,626	
	DSM, Class 2, WY	6	10	11	13	15	13	14	15	15	16	13	13	14	15	15	15	15	15	15	15	128	274	
	DSM, Class 2 Total	79	95	103	113	122	106	108	110	115	113	98	99	99	99	97	90	88	88	83	85	1,064	1,990	
	FOT Mona Q3	-	-	-	-	-	-	-	97	79	80	106	142	215	179	-	154	148	300	75	300	26	94	
	Existing Plant Retirements/Conversions																							
	JimBridger 1 (Coal Early Retirement/Conversions)	-	-	-	-	-	-	-	-	-	(354)	-	-	-	-	-	-	-	-	-	-	-	(354)	
	JimBridger 2 (Coal Early Retirement/Conversions)	-	-	-	-	-	-	-	-	-	-	-	-	-	-	(359)	-	-	-	-	-	-	(359)	
	Expansion Resources																							
	Oregon Solar Capacity Standard	-	7	-	-	-	-	-	-	-	-	-	-	-	-	-	-	-	-	-	-	-	7	
	DSM, Class 1, OR-Curtail	-	-	-	-	-	-	-	-	-	10.6	-	10.6	-	-	-	-	10.6	-	-	-	-	10.6	
	DSM, Class 1, OR-DLC-RES	-	-	-	-	-	-	-	-	3.7	-	-	-	-	-	-	-	-	-	-	-	-	3.7	
	DSM, Class 1, OR-Irrigate	-	-	-	-	-	-	-	3.4	-	-	5.0	-	-	-	-	-	-	-	-	-	-	3.4	
	DSM, Class 1 Total	-	-	-	-	-	-	-	3.4	3.7	10.6	5.0	10.6	-	-	-	-	10.6	-	-	-	-	17.7	
	DSM, Class 2, CA	1	2	2	2	2	2	2	2	2	2	1	1	1	1	2	1	1	1	1	1	1	17	
	DSM, Class 2, OR	44	40	39	39	39	37	35	32	31	28	17	16	14	14	12	11	11	11	10	11	362	486	
	DSM, Class 2, WA	8	9	10	10	11	10	10	10	10	9	9	8	8	8	7	6	6	6	6	6	98	170	
	DSM, Class 2 Total	54	51	51	51	52	48	46	43	42	39	27	26	23	23	21	19	18	19	17	17	476	686	
	FOT COB Q3	-	87	134	86	235	250	-	268	268	268	268	268	268	268	80	268	268	262	182	263	160	199	
	FOT MidColumbia Q3	400	400	400	400	400	400	400	400	400	400	400	400	400	400	400	400	400	400	400	400	400	400	
	FOT MidColumbia Q3 - 2	227	375	375	375	375	375	291	375	375	375	375	375	375	375	375	375	375	375	375	375	352	363	
	FOT NOB Q3	100	100	100	100	100	100	100	100	100	100	100	100	100	100	100	100	100	100	100	100	100	100	
	Existing Plant Retirements/Conversions	(222)	-	-	-	(106)	-	-	(450)	-	(460)	(728)	-	-	(220)	(359)	(694)	(77)	-	(956)	-	-	-	
	Annual Additions, Long Term Resources	133	153	154	164	175	260	154	156	160	640	976	135	122	546	752	510	117	133	1,370	136	-	-	
	Annual Additions, Short Term Resources	727	962	1,009	961	1,110	1,125	791	1,240	1,222	1,223	1,249	1,285	1,358	1,322	955	1,297	1,291	1,437	1,132	1,438	-	-	
	Total Annual Additions	859	1,114	1,163	1,125	1,285	1,385	945	1,396	1,382	1,864	2,225	1,420	1,480	1,868	1,707	1,806	1,408	1,570	2,502	1,574	-	-	

1/ Front office transaction amounts reflect one-year transaction periods, are not additive, and are reported as a 10/20-year annual average.

Case C12-1		Capacity (MW)																				Resource Totals 1/		
		2015	2016	2017	2018	2019	2020	2021	2022	2023	2024	2025	2026	2027	2028	2029	2030	2031	2032	2033	2034	10-year	20-year	
East	Existing Plant Retirements/Conversions																							
	Hayden 1	-	-	-	-	-	-	-	-	-	-	-	-	-	-	-	-	-	(45)	-	-	-	(45)	
	Hayden 2	-	-	-	-	-	-	-	-	-	-	-	-	-	-	-	-	-	(33)	-	-	-	(33)	
	Hunter 2 (Coal Early Retirement/Conversions)	-	-	-	-	-	-	-	-	-	-	-	-	-	-	-	-	-	-	(269)	-	-	(269)	
	Huntington 2 (Coal Early Retirement/Conversions)	-	-	-	-	-	-	-	(450)	-	-	-	-	-	-	-	-	-	-	-	-	-	(450)	
	Carbon 1 (Coal Early Retirement/Conversions)	(67)	-	-	-	-	-	-	-	-	-	-	-	-	-	-	-	-	-	-	-	-	(67)	
	Carbon 2 (Coal Early Retirement/Conversions)	(105)	-	-	-	-	-	-	-	-	-	-	-	-	-	-	-	-	-	-	-	-	(105)	
	Cholla 4 (Coal Early Retirement/Conversions)	-	-	-	-	-	-	-	-	-	-	(387)	-	-	-	-	-	-	-	-	-	-	(387)	
	DaveJohnston 1 (Coal Early Retirement/Conversions)	-	-	-	-	(106)	-	-	-	-	-	-	-	-	-	-	-	-	-	-	-	-	(106)	
	DaveJohnston 2	-	-	-	-	-	-	-	-	-	-	-	-	-	(106)	-	-	-	-	-	-	-	(106)	
	DaveJohnston 3	-	-	-	-	-	-	-	-	-	-	-	-	-	(220)	-	-	-	-	-	-	-	(220)	
	DaveJohnston 4	-	-	-	-	-	-	-	-	-	-	-	-	-	-	-	-	-	(330)	-	-	-	(330)	
	Naughton 1	-	-	-	-	-	-	-	-	-	-	-	-	-	-	-	(156)	-	-	-	-	-	(156)	
	Naughton 2	-	-	-	-	-	-	-	-	-	-	-	-	-	-	-	(201)	-	-	-	-	-	(201)	
	Naughton 3 (Coal Early Retirement/Conversions)	(50)	-	-	(280)	-	-	-	-	-	-	-	-	-	-	-	-	-	-	-	-	-	(330)	
	Gadsby 1-6	-	-	-	-	-	-	-	-	-	-	-	-	-	-	-	-	-	(358)	-	-	-	(358)	
	Coal Ret_AZ - Gas RePower	-	-	-	-	-	-	-	-	-	-	387	-	-	-	-	-	-	-	-	-	-	387	
	Coal Ret_WY - Gas RePower	-	-	-	337	-	-	-	-	-	-	-	-	-	-	-	(337)	-	-	-	-	-	337	
	Expansion Resources																							
	CCCT - DJohns - F 1x1	-	-	-	-	-	-	-	-	-	-	-	-	-	-	313	-	-	-	-	-	313	627	
	CCCT - Huntington - J 1x1	-	-	-	-	-	-	-	-	-	-	-	-	-	423	-	-	-	-	-	-	-	423	
	CCCT - Naughton - J 1x1	-	-	-	-	-	-	-	-	-	-	-	-	-	-	-	-	-	-	401	-	-	401	
	CCCT - Utah-N - F 2x1	-	-	-	-	-	-	-	-	-	-	-	-	-	-	-	-	-	-	635	-	-	635	
	CCCT - Utah-S - J 1x1	-	-	-	-	-	-	-	-	-	423	-	-	-	-	-	-	423	-	-	-	-	423	
	Total CCCT	-	-	-	-	-	-	-	-	-	423	-	-	-	-	736	-	423	-	-	1,036	313	423	2,932
	Wind, DJohnston, 43	-	-	-	-	-	106	-	-	-	-	-	-	-	13	-	-	-	-	16	-	-	106	
	Total Wind	-	-	-	-	-	106	-	-	-	-	-	-	-	13	-	-	-	-	16	-	-	106	
	Utility Solar - PV - East	-	-	-	-	-	-	-	-	63	-	-	-	-	-	-	-	-	-	-	-	-	63	
	DSM, Class 1, ID-Irrigate	-	-	-	-	-	-	-	-	-	-	-	-	-	-	-	-	-	11.2	-	-	-	11.2	
	DSM, Class 1, UT-DLC-RES	-	-	-	-	-	-	-	-	-	-	-	-	-	-	-	-	-	4.9	-	-	-	4.9	
DSM, Class 1, UT-Irrigate	-	-	-	-	-	-	-	-	-	-	-	-	-	-	-	-	-	3.5	-	-	-	3.5		
DSM, Class 1, WY-Curtail	-	-	-	-	-	-	-	-	-	-	-	-	-	-	-	-	-	16.2	-	-	-	16.2		
DSM, Class 1 Total	-	-	-	-	-	-	-	-	-	-	-	-	-	-	-	-	-	35.8	-	-	-	35.8		
DSM, Class 2, ID	4	4	5	5	5	4	4	4	5	5	5	5	5	5	5	4	4	4	4	4	4	45		
DSM, Class 2, UT	69	78	84	86	92	80	84	90	91	90	78	81	80	84	81	75	74	73	63	64	843	1,596		
DSM, Class 2, WY	7	8	10	12	14	12	13	14	15	16	13	13	14	14	15	15	15	16	15	15	121	267		
DSM, Class 2 Total	79	90	99	102	111	97	101	108	110	111	95	99	98	103	100	95	94	94	82	83	1,009	1,952		
FOT Mona Q3	-	-	-	-	10	38	-	168	128	60	132	162	229	44	44	178	165	300	300	300	40	113		
Existing Plant Retirements/Conversions																								
JimBridger 1 (Coal Early Retirement/Conversions)	-	-	-	-	-	-	-	-	-	(354)	-	-	-	-	-	-	-	-	-	-	-	(354)		
JimBridger 2 (Coal Early Retirement/Conversions)	-	-	-	-	-	-	-	-	-	-	-	-	-	-	-	-	-	-	(359)	-	-	(359)		
Expansion Resources																								
CCCT - SOregonCal - J 1x1	-	-	-	-	-	-	-	-	-	-	-	-	-	-	-	-	-	-	454	-	-	454		
Total CCCT	-	-	-	-	-	-	-	-	-	-	-	-	-	-	-	-	-	-	454	-	-	454		
Oregon Solar Capacity Standard	-	7	-	-	-	-	-	-	-	-	-	-	-	-	-	-	-	-	-	-	7	7		
DSM, Class 1, OR-Curtail	-	-	-	-	-	-	-	-	10.6	-	10.6	10.6	-	-	-	-	-	-	-	-	10.6	31.8		
DSM, Class 1, OR-DLC-RES	-	-	-	-	-	-	-	-	-	-	-	-	-	-	-	-	4.5	-	-	-	-	4.5		
DSM, Class 1, OR-Irrigate	-	-	-	-	-	-	-	-	5.0	-	-	-	-	-	-	3.4	-	-	-	-	5.0	8.4		
DSM, Class 1 Total	-	-	-	-	-	-	-	-	5.0	10.6	-	10.6	-	-	-	3.4	-	-	-	-	15.6	44.7		
DSM, Class 2, CA	1	2	2	2	2	1	1	2	2	2	1	1	1	1	1	1	1	1	1	1	1	16		
DSM, Class 2, OR	44	39	35	32	29	27	25	25	23	23	21	21	22	22	21	20	21	21	18	19	302	507		
DSM, Class 2, WA	8	9	10	10	11	9	10	10	11	11	9	9	9	9	8	8	8	7	7	7	98	180		
DSM, Class 2 Total	54	49	47	44	42	38	36	36	36	35	31	31	32	32	31	30	30	27	27	27	416	716		
FOT COB Q3	-	93	148	113	268	268	-	268	268	268	268	268	268	225	91	268	268	258	122	160	169	194		
FOT MidColumbia Q3	400	400	400	400	400	400	400	400	400	400	400	400	400	400	400	400	400	400	400	400	400	400		
FOT MidColumbia Q3 - 2	227	375	375	375	375	375	359	375	375	375	375	375	375	375	375	375	375	375	375	375	359	367		
FOT NOB Q3	100	100	100	100	100	100	100	100	100	100	100	100	100	100	100	100	100	100	100	100	100	100		
Existing Plant Retirements/Conversions	(222)	-	-	57	(106)	-	-	(450)	-	(354)	-	-	-	(326)	-	(694)	(77)	-	(1,316)	-	-	-		
Annual Additions, Long Term Resources	133	146	146	146	153	241	137	149	220	569	137	140	130	884	135	547	128	160	1,615	423	-	-		
Annual Additions, Short Term Resources	727	968	1,023	988	1,152	1,181	859	1,311	1,271	1,203	1,275	1,305	1,372	1,144	1,010	1,321	1,308	1,433	1,297	1,335	-	-		
Total Annual Additions	860	1,114	1,169	1,134	1,305	1,421	996	1,461	1,491	1,772	1,411	1,445	1,502	2,028	1,146	1,868	1,437	1,592	2,912	1,758	-	-		

1/ Front office transaction amounts reflect one-year transaction periods, are not additive, and are reported as a 10/20-year annual average.

Case C12-2		Capacity (MW)																							Resource Totals 1/	
		2015	2016	2017	2018	2019	2020	2021	2022	2023	2024	2025	2026	2027	2028	2029	2030	2031	2032	2033	2034	10-year	20-year			
East	Existing Plant Retirements/Conversions																									
	Hayden 1	-	-	-	-	-	-	-	-	-	-	-	-	-	-	-	-	-	(45)	-	-	-	(45)			
	Hayden 2	-	-	-	-	-	-	-	-	-	-	-	-	-	-	-	-	-	(33)	-	-	-	(33)			
	Hunter 2 (Coal Early Retirement/Conversions)	-	-	-	-	-	-	-	-	-	-	(269)	-	-	-	-	-	-	-	-	-	-	(269)			
	Huntington 1 (Coal Early Retirement/Conversions)	-	-	-	-	-	-	-	-	-	-	(459)	-	-	-	-	-	-	-	-	-	-	(459)			
	Huntington 2 (Coal Early Retirement/Conversions)	-	-	-	-	-	-	-	(450)	-	-	-	-	-	-	-	-	-	-	-	-	-	(450)	(450)		
	Carbon 1 (Coal Early Retirement/Conversions)	(67)	-	-	-	-	-	-	-	-	-	-	-	-	-	-	-	-	-	-	-	-	(67)	(67)		
	Carbon 2 (Coal Early Retirement/Conversions)	(105)	-	-	-	-	-	-	-	-	-	-	-	-	-	-	-	-	-	-	-	-	(105)	(105)		
	Cholla 4 (Coal Early Retirement/Conversions)	-	-	-	-	-	-	-	-	-	-	(387)	-	-	-	-	-	-	-	-	-	-	-	(387)		
	DaveJohnston 1 (Coal Early Retirement/Conversions)	-	-	-	-	(106)	-	-	-	-	-	-	-	-	-	-	-	-	-	-	-	-	(106)	(106)		
	DaveJohnston 2 (Coal Early Retirement/Conversions)	-	-	-	-	-	-	-	-	-	(106)	-	-	-	-	-	-	-	-	-	-	-	(106)	(106)		
	DaveJohnston 3	-	-	-	-	-	-	-	-	-	-	-	-	-	-	(220)	-	-	-	-	-	-	-	(220)		
	DaveJohnston 4	-	-	-	-	-	-	-	-	-	-	-	-	-	-	-	-	-	-	-	(330)	-	-	(330)		
	Naughton 1	-	-	-	-	-	-	-	-	-	-	-	-	-	-	-	-	(156)	-	-	-	-	-	(156)		
	Naughton 2	-	-	-	-	-	-	-	-	-	-	-	-	-	-	-	(201)	-	-	-	-	-	-	(201)		
	Naughton 3 (Coal Early Retirement/Conversions)	(50)	-	-	(280)	-	-	-	-	-	-	-	-	-	-	-	-	-	-	-	-	-	(330)	(330)		
	Wyodak (Coal Early Retirement/Conversions)	-	-	-	-	-	-	-	-	-	-	-	-	-	-	-	-	-	-	-	(268)	-	-	(268)		
	Cadsby 1-6	-	-	-	-	-	-	-	-	-	-	-	-	-	-	-	-	-	-	-	(358)	-	-	(358)		
	Coal Ret. AZ - Gas RePower	-	-	-	-	-	-	-	-	-	-	387	-	-	-	-	-	-	-	-	-	-	-	387		
	Coal Ret. WY - Gas RePower	-	-	-	337	-	-	-	-	-	-	-	-	-	-	-	-	(337)	-	-	-	-	337	-		
	Expansion Resources																									
	CCCT - DJohns - F 2xl	-	-	-	-	-	-	-	-	-	-	-	-	-	-	-	-	-	-	-	635	-	-	635		
	CCCT - Huntington - J 1xl	-	-	-	-	-	-	-	-	-	-	-	-	-	-	-	423	423	-	-	-	-	-	846		
	CCCT - Naughton - J 1xl	-	-	-	-	-	-	-	-	-	-	-	-	-	-	-	-	-	-	401	-	-	-	401		
	CCCT - Utah-N - J 1xl	-	-	-	-	-	-	-	-	-	-	-	-	-	-	-	-	-	-	-	-	423	-	423		
	CCCT - Utah-S - J 1xl	-	-	-	-	-	-	-	-	-	-	423	423	-	-	-	-	-	-	-	-	-	423	846		
	Total CCCT	-	-	-	-	-	-	-	-	-	-	423	423	-	-	-	423	423	-	401	635	423	423	3,151		
	Wind, DJohnston, 43	-	-	-	-	106	-	-	-	-	21	-	-	-	-	-	-	-	-	-	-	-	127	127		
	Total Wind	-	-	-	-	106	-	-	-	-	21	-	-	-	-	-	-	-	-	-	-	-	127	127		
	Utility Solar - PV - East	-	-	-	-	-	-	-	-	-	55	-	-	-	-	-	-	-	-	-	-	-	55	55		
	DSM, Class 1, ID-Irrigate	-	-	-	-	-	-	-	-	-	-	-	-	-	-	-	-	-	-	24.6	-	-	-	24.6		
	DSM, Class 1, UT-DLC-RES	-	-	-	-	-	-	-	-	-	-	-	-	-	-	-	-	-	-	-	28.4	-	-	28.4		
	DSM, Class 1, UT-Irrigate	-	-	-	-	-	-	-	-	-	-	-	-	-	-	-	-	-	-	-	16.5	-	-	16.5		
	DSM, Class 1 Total	-	-	-	-	-	-	-	-	-	-	-	-	-	-	-	-	-	-	-	69.4	-	-	69.4		
	DSM, Class 2, ID	4	4	5	5	5	4	4	4	5	5	5	5	5	5	5	5	4	4	4	5	4	45	91		
	DSM, Class 2, UT	69	78	84	86	92	80	86	90	91	94	81	81	84	84	81	75	74	73	73	66	849	1,621			
	DSM, Class 2, WY	7	8	10	12	14	12	13	14	15	16	13	13	14	15	15	15	15	17	15	122	270				
DSM, Class 2 Total	79	90	99	102	111	97	103	108	110	115	99	99	102	104	101	95	94	94	86	1,015	1,982					
FOT Mona Q3	-	-	-	-	9	38	-	-	168	146	152	202	181	245	151	75	300	300	300	300	300	51	143			
West Existing Plant Retirements/Conversions																										
JimBridger 1 (Coal Early Retirement/Conversions)	-	-	-	-	-	-	-	-	-	(354)	-	-	-	-	-	-	-	-	-	-	-	(354)	(354)			
JimBridger 2 (Coal Early Retirement/Conversions)	-	-	-	-	-	-	-	-	-	-	-	-	-	-	-	(359)	-	-	-	-	-	-	(359)			
Expansion Resources																										
CCCT - SOregonCal - J 1xl	-	-	-	-	-	-	-	-	-	-	454	-	-	-	-	-	-	-	-	-	-	-	454			
CCCT - WillamValce - J 1xl	-	-	-	-	-	-	-	-	-	-	-	-	-	477	-	-	-	-	-	-	-	-	477			
Total CCCT	-	-	-	-	-	-	-	-	-	-	454	-	-	477	-	-	-	-	-	-	-	-	932			
Oregon Solar Capacity Standard	-	7	-	-	-	-	-	-	-	-	-	-	-	-	-	-	-	-	-	-	-	7	7			
DSM, Class 1, OR-Curtail	-	-	-	-	-	-	-	-	-	10.6	-	10.6	-	-	-	-	-	-	-	-	-	10.6	21.2			
DSM, Class 1, OR-Irrigate	-	-	-	-	-	-	-	3.4	5.0	-	-	-	-	-	-	-	-	-	-	-	-	8.4	8.4			
DSM, Class 1 Total	-	-	-	-	-	-	-	3.4	15.6	-	10.6	-	-	-	-	-	-	-	-	-	-	19.0	29.6			
DSM, Class 2, CA	1	2	2	2	2	1	1	2	2	2	1	1	1	1	1	1	1	1	1	1	1	16	29			
DSM, Class 2, OR	44	39	35	32	29	27	25	25	23	23	21	22	22	22	21	20	20	21	20	19	302	509				
DSM, Class 2, WA	8	9	10	10	11	9	10	10	11	11	9	9	9	9	9	8	8	8	8	7	98	180				
DSM, Class 2 Total	54	49	47	44	42	38	36	36	35	31	32	32	32	31	30	29	30	28	27	416	718					
FOT COB Q3	-	93	148	113	268	268	-	268	268	268	207	268	268	268	182	268	260	71	264	211	169	198				
FOT MidColumbia Q3	400	400	400	400	400	400	400	400	400	400	400	400	400	400	400	400	400	400	400	400	400	400	400			
FOT MidColumbia Q3 - 2	227	375	375	375	375	375	375	375	375	375	375	375	375	375	375	375	375	375	375	375	375	375	367			
FOT NOB Q3	100	100	100	100	100	100	100	100	100	100	100	100	100	100	100	100	100	100	100	100	100	100	100			
Existing Plant Retirements/Conversions	(222)	-	-	57	(106)	-	-	(450)	-	(460)	(728)	-	-	(220)	(359)	(694)	(77)	-	-	(956)	-	-				
Annual Additions, Long Term Resources	133	146	146	146	153	241	139	148	162	649	1,017	131	134	613	555	547	123	525	827	535	-	-				
Annual Additions, Short Term Resources	727	968	1,023	988	1,152	1,180	857	1,311	1,289	1,294	1,284	1,324	1,388	1,294	1,132	1,443	1,435	1,246	1,439	1,386	-	-				
Total Annual Additions	860	1,114	1,169	1,134	1,305	1,421	996	1,459	1,451	1,943	2,301	1,455	1,522	1,908	1,687	1,990	1,558	1,771	2,266	1,921	-	-				

1/ Front office transaction amounts reflect one-year transaction periods, are not additive, and are reported as a 10/20-year annual average.

Case C13-1		Capacity (MW)																			Resource Totals 1/			
		2015	2016	2017	2018	2019	2020	2021	2022	2023	2024	2025	2026	2027	2028	2029	2030	2031	2032	2033	2034	10-year	20-year	
East	Existing Plant Retirements/Conversions																							
	Hayden 1	-	-	-	-	-	-	-	-	-	-	-	-	-	-	-	-	(45)	-	-	-	-	(45)	
	Hayden 2	-	-	-	-	-	-	-	-	-	-	-	-	-	-	-	-	(33)	-	-	-	-	(33)	
	Hunter 2 (Coal Early Retirement/Conversions)	-	-	-	-	-	-	-	-	-	-	-	-	-	-	-	-	-	-	(269)	-	-	(269)	
	Huntington 2 (Coal Early Retirement/Conversions)	-	-	-	-	-	-	-	(450)	-	-	-	-	-	-	-	-	-	-	-	-	(450)	(450)	
	Carbon 1 (Coal Early Retirement/Conversions)	(67)	-	-	-	-	-	-	-	-	-	-	-	-	-	-	-	-	-	-	-	(67)	(67)	
	Carbon 2 (Coal Early Retirement/Conversions)	(105)	-	-	-	-	-	-	-	-	-	-	-	-	-	-	-	-	-	-	-	(105)	(105)	
	Cholla 4 (Coal Early Retirement/Conversions)	-	-	-	-	-	-	-	-	-	-	(387)	-	-	-	-	-	-	-	-	-	-	(387)	
	DaveJohnston 1 (Coal Early Retirement/Conversions)	-	-	-	-	(106)	-	-	-	-	-	-	-	-	-	-	-	-	-	-	-	(106)	(106)	
	DaveJohnston 2	-	-	-	-	-	-	-	-	-	-	-	-	-	(106)	-	-	-	-	-	-	-	(106)	
	DaveJohnston 3	-	-	-	-	-	-	-	-	-	-	-	-	-	(220)	-	-	-	-	-	-	-	(220)	
	DaveJohnston 4	-	-	-	-	-	-	-	-	-	-	-	-	-	-	-	-	-	-	(330)	-	-	(330)	
	Naughton 1	-	-	-	-	-	-	-	-	-	-	-	-	-	-	-	(156)	-	-	-	-	-	(156)	
	Naughton 2	-	-	-	-	-	-	-	-	-	-	-	-	-	-	-	(201)	-	-	-	-	-	(201)	
	Naughton 3 (Coal Early Retirement/Conversions)	(50)	-	-	(280)	-	-	-	-	-	-	-	-	-	-	-	-	-	-	-	-	(330)	(330)	
	Gadsby 1-6	-	-	-	-	-	-	-	-	-	-	-	-	-	-	-	-	-	-	(358)	-	-	(358)	
	Coal Ret_AZ - Gas RePower	-	-	-	-	-	-	-	-	-	-	387	-	-	-	-	-	-	-	-	-	-	387	
	Coal Ret_WY - Gas RePower	-	-	-	337	-	-	-	-	-	-	-	-	-	-	-	-	(337)	-	-	-	337	-	
	Expansion Resources																							
	CCCT - DJohns - F 1xl	-	-	-	-	-	-	-	-	-	-	-	-	-	313	-	-	-	-	-	-	-	313	
	CCCT - DJohns - J 1xl	-	-	-	-	-	-	-	-	-	-	-	-	-	-	-	-	-	-	423	-	-	423	
	CCCT - Huntington - J 1xl	-	-	-	-	-	-	-	-	-	-	-	-	-	-	-	-	-	423	-	-	-	423	
	CCCT - Naughton - J 1xl	-	-	-	-	-	-	-	-	-	-	-	-	-	-	-	-	-	-	401	-	-	401	
	CCCT - Utah-S - F 2xl	-	-	-	-	-	-	-	-	-	-	-	-	-	-	-	635	-	-	-	-	-	635	
	Total CCCT	-	-	-	-	-	-	-	-	-	-	-	-	-	313	-	635	-	423	824	-	-	2,195	
	Wind, DJohnston, 43	-	-	-	-	-	25	-	-	-	-	-	-	-	-	-	-	-	-	-	-	25	25	
	Total Wind	-	-	-	-	-	25	-	-	-	-	-	-	-	-	-	-	-	-	-	-	25	25	
	Utility Solar - PV - East	-	-	-	-	-	154	-	-	-	-	-	-	-	0	-	-	-	-	-	-	154	154	
	DSM, Class 1, ID-Irrigate	-	-	-	-	-	-	-	-	-	-	-	-	-	-	-	-	-	-	-	25.9	-	25.9	
	DSM, Class 1, UT-Irrigate	-	-	-	-	-	-	-	-	-	-	-	-	-	-	-	-	-	-	-	12.5	-	12.5	
	DSM, Class 1 Total	-	-	-	-	-	-	-	-	-	-	-	-	-	-	-	-	-	-	-	38.4	-	38.4	
	DSM, Class 2, ID	4	4	5	5	5	4	4	5	6	6	5	5	5	5	5	4	4	4	4	4	4	47	92
	DSM, Class 2, UT	69	78	84	86	92	83	86	90	98	101	81	85	84	84	75	72	71	73	71	73	865	1,633	
	DSM, Class 2, WY	7	8	10	12	14	12	13	14	15	16	13	13	14	15	15	14	15	16	16	17	122	270	
	DSM, Class 2 Total	79	90	99	102	111	99	103	109	118	123	99	103	103	104	94	90	91	93	91	94	1,034	1,995	
FOT Mona Q3	-	-	-	-	9	-	-	-	114	-	-	75	94	157	300	175	273	268	300	300	278	12	117	
Existing Plant Retirements/Conversions																								
JimBridger 1 (Coal Early Retirement/Conversions)	-	-	-	-	-	-	-	-	-	(354)	-	-	-	-	-	-	-	-	-	-	(354)	(354)		
JimBridger 2 (Coal Early Retirement/Conversions)	-	-	-	-	-	-	-	-	-	-	-	-	-	-	-	-	-	-	(359)	-	-	(359)		
Expansion Resources																								
CCCT - SOregonCal - J 1xl	-	-	-	-	-	-	-	-	-	-	-	-	-	-	-	-	-	-	454	454	-	909		
CCCT - WillamValcc - J 1xl	-	-	-	-	-	-	-	-	477	-	-	-	-	-	-	-	-	-	-	-	-	477		
Total CCCT	-	-	-	-	-	-	-	-	477	-	-	-	-	-	-	-	-	-	454	454	-	1,386		
Wind, YK, 29	-	-	-	-	-	-	-	-	22	-	-	-	-	-	-	-	-	-	-	-	22	22		
Total Wind	-	-	-	-	-	-	-	-	22	-	-	-	-	-	-	-	-	-	-	-	22	22		
Oregon Solar Capacity Standard	-	7	-	-	-	-	-	-	-	-	-	-	-	-	-	-	-	-	-	-	-	7		
DSM, Class 1, OR-Irrigate	-	-	-	-	-	-	-	-	5.0	-	-	-	-	-	-	-	-	-	-	-	5.0	5.0		
DSM, Class 1 Total	-	-	-	-	-	-	-	-	5.0	-	-	-	-	-	-	-	-	-	-	-	5.0	5.0		
DSM, Class 2, CA	1	2	2	2	2	1	1	2	2	2	1	1	1	1	1	1	1	1	1	1	1	16	29	
DSM, Class 2, OR	44	39	35	32	29	27	25	25	23	23	22	22	22	22	20	19	19	19	18	18	302	503		
DSM, Class 2, WA	8	9	10	10	11	9	10	10	11	11	9	9	9	9	8	8	8	8	7	7	98	179		
DSM, Class 2 Total	54	49	47	44	42	38	36	36	36	35	32	32	32	32	29	28	28	27	26	26	417	710		
FOT COB Q3	-	93	148	113	268	258	-	268	-	245	249	268	268	268	268	268	268	30	105	-	139	169		
FOT MidColumbia Q3	400	400	400	400	400	400	400	400	400	400	400	400	400	400	400	400	400	400	400	400	400	400		
FOT MidColumbia Q3 - 2	227	375	375	375	375	375	310	375	328	375	375	375	375	375	375	375	375	375	375	375	349	362		
FOT NOB Q3	100	100	100	100	100	100	100	100	100	100	100	100	100	100	100	100	100	100	100	100	100	100		
Existing Plant Retirements/Conversions	(222)	-	-	57	(106)	-	-	(450)	-	(354)	-	-	-	(326)	-	(694)	(77)	-	(1,316)	-				
Annual Additions, Long Term Resources	133	147	146	146	153	316	139	172	632	158	130	135	135	450	123	753	119	544	1,396	613				
Annual Additions, Short Term Resources	727	968	1,023	988	1,152	1,133	810	1,257	828	1,120	1,199	1,237	1,300	1,443	1,318	1,416	1,411	1,205	1,280	1,153				
Total Annual Additions	860	1,114	1,169	1,134	1,305	1,449	949	1,429	1,459	1,278	1,330	1,372	1,435	1,892	1,441	2,170	1,530	1,748	2,676	1,766				

1/ Front office transaction amounts reflect one-year transaction periods, are not additive, and are reported as a 10/20-year annual average.

Case C13-2		Capacity (MW)																				Resource Totals 1/		
		2015	2016	2017	2018	2019	2020	2021	2022	2023	2024	2025	2026	2027	2028	2029	2030	2031	2032	2033	2034	10-year	20-year	
East	Existing Plant Retirements/Conversions																							
	Hayden 1	-	-	-	-	-	-	-	-	-	-	-	-	-	-	-	-	-	(45)	-	-	-	-	(45)
	Hayden 2	-	-	-	-	-	-	-	-	-	-	-	-	-	-	-	-	-	(33)	-	-	-	-	(33)
	Hunter 2 (Coal Early Retirement/Conversions)	-	-	-	-	-	-	-	-	-	-	-	-	-	-	-	-	-	-	-	-	-	-	(269)
	Huntington 1 (Coal Early Retirement/Conversions)	-	-	-	-	-	-	-	-	-	-	-	-	-	-	-	-	-	-	-	-	-	-	(459)
	Huntington 2 (Coal Early Retirement/Conversions)	-	-	-	-	-	-	-	(450)	-	-	-	-	-	-	-	-	-	-	-	-	-	-	(450)
	Carbon 1 (Coal Early Retirement/Conversions)	(67)	-	-	-	-	-	-	-	-	-	-	-	-	-	-	-	-	-	-	-	-	-	(67)
	Carbon 2 (Coal Early Retirement/Conversions)	(105)	-	-	-	-	-	-	-	-	-	-	-	-	-	-	-	-	-	-	-	-	-	(105)
	Cholla 4 (Coal Early Retirement/Conversions)	-	-	-	-	-	-	-	-	-	-	(387)	-	-	-	-	-	-	-	-	-	-	-	(387)
	DaveJohnston 1 (Coal Early Retirement/Conversions)	-	-	-	-	(106)	-	-	-	-	-	-	-	-	-	-	-	-	-	-	-	-	-	(106)
	DaveJohnston 2 (Coal Early Retirement/Conversions)	-	-	-	-	-	-	-	-	-	(106)	-	-	-	-	-	-	-	-	-	-	-	-	(106)
	DaveJohnston 3	-	-	-	-	-	-	-	-	-	-	-	-	-	-	(220)	-	-	-	-	-	-	-	(220)
	DaveJohnston 4	-	-	-	-	-	-	-	-	-	-	-	-	-	-	-	-	-	-	-	(330)	-	-	(330)
	Naughton 1	-	-	-	-	-	-	-	-	-	-	-	-	-	-	-	-	(156)	-	-	-	-	-	(156)
	Naughton 2	-	-	-	-	-	-	-	-	-	-	-	-	-	-	-	(201)	-	-	-	-	-	-	(201)
	Naughton 3 (Coal Early Retirement/Conversions)	(50)	-	-	(280)	-	-	-	-	-	-	-	-	-	-	-	-	-	-	-	-	-	(330)	(330)
	Wyodak (Coal Early Retirement/Conversions)	-	-	-	-	-	-	-	-	-	-	-	-	-	-	-	-	-	-	(268)	-	-	-	(268)
	Gadsby 1-6	-	-	-	-	-	-	-	-	-	-	-	-	-	-	-	-	-	-	(358)	-	-	-	(358)
	Coal Ret. AZ - Gas RePower	-	-	-	-	-	-	-	-	-	-	387	-	-	-	-	-	-	-	-	-	-	-	387
	Coal Ret. WY - Gas RePower	-	-	-	337	-	-	-	-	-	-	-	-	-	-	-	-	(337)	-	-	-	-	-	337
	Expansion Resources																							
	CCCT - DJohns - F 2xl	-	-	-	-	-	-	-	-	-	-	-	-	-	-	-	-	-	-	635	-	-	-	635
	CCCT - Huntington - J 1xl	-	-	-	-	-	-	-	-	-	-	423	-	-	423	-	-	-	-	-	-	-	-	846
	CCCT - Naughton - J 1xl	-	-	-	-	-	-	-	-	-	-	-	-	-	-	-	401	-	-	-	-	-	-	401
	CCCT - Utah-N - J 1xl	-	-	-	-	-	-	-	-	-	-	-	-	-	-	-	-	-	-	-	423	-	-	423
	CCCT - Utah-S - J 1xl	-	-	-	-	-	-	-	-	423	423	-	-	-	-	-	-	-	-	-	-	-	-	846
	Total CCCT	-	-	-	-	-	-	-	-	423	423	423	-	-	423	-	-	-	-	635	423	-	-	846
	Wind, DJohnston, 43	-	-	-	-	-	106	-	-	-	21	-	-	-	-	-	-	-	-	-	-	-	-	127
	Total Wind	-	-	-	-	-	106	-	-	-	21	-	-	-	-	-	-	-	-	-	-	-	-	127
	Utility Solar - PV - East	-	-	-	-	-	-	-	-	-	55	-	-	-	-	-	-	-	-	-	-	-	-	55
	DSM, Class 1, ID-Irrigate	-	-	-	-	-	-	-	-	-	-	-	-	-	-	-	11.2	-	-	13.4	-	-	-	24.6
	DSM, Class 1, UT-Irrigate	-	-	-	-	-	-	-	-	-	-	-	-	-	-	-	6.6	-	-	9.9	-	-	-	16.5
	DSM, Class 1 Total	-	-	-	-	-	-	-	-	-	-	-	-	-	-	-	17.8	-	-	23.3	-	-	-	41.0
	DSM, Class 2, ID	4	4	5	5	5	4	4	4	5	6	5	5	5	5	5	4	4	4	4	4	4	4	92
	DSM, Class 2, UT	69	78	84	86	92	83	86	93	95	105	85	85	84	84	81	75	74	73	71	64	870	1,645	
	DSM, Class 2, WY	7	8	10	12	14	12	13	14	15	16	13	13	14	15	15	16	15	16	17	15	122	271	
	DSM, Class 2 Total	79	90	99	102	111	99	103	112	115	127	103	103	104	104	101	95	94	93	92	83	1,038	2,008	
	FOT Mona Q3	-	-	-	-	9	36	-	151	-	-	147	184	247	200	44	300	292	300	300	300	20	126	
	Existing Plant Retirements/Conversions																							
	JimBridger 1 (Coal Early Retirement/Conversions)	-	-	-	-	-	-	-	-	-	(354)	-	-	-	-	-	-	-	-	-	-	-	-	(354)
JimBridger 2 (Coal Early Retirement/Conversions)	-	-	-	-	-	-	-	-	-	-	-	-	-	-	-	(359)	-	-	-	-	-	-	(359)	
Expansion Resources																								
CCCT - SOregonCal - J 1xl	-	-	-	-	-	-	-	-	-	-	-	-	-	-	-	-	-	454	-	-	-	454		
CCCT - WillamValce - J 1xl	-	-	-	-	-	-	-	-	-	-	-	-	-	-	-	477	-	-	-	-	-	477		
Total CCCT	-	-	-	-	-	-	-	-	-	-	-	-	-	-	-	477	-	-	454	-	-	-	932	
Oregon Solar Capacity Standard	-	7	-	-	-	-	-	-	-	-	-	-	-	-	-	-	-	-	-	-	-	7		
DSM, Class 1, OR-Curtail	-	-	-	-	-	-	-	10.6	-	10.6	-	-	-	-	-	-	-	-	-	-	-	21.2		
DSM, Class 1, OR-Irrigate	-	-	-	-	-	-	-	5.0	-	3.4	-	-	-	-	-	-	-	-	-	-	-	8.4		
DSM, Class 1 Total	-	-	-	-	-	-	-	15.6	-	14.0	-	-	-	-	-	-	-	-	-	-	-	29.6		
DSM, Class 2, CA	1	2	2	2	2	1	1	2	2	2	1	1	1	1	2	1	1	1	1	1	1	16		
DSM, Class 2, OR	44	39	35	32	29	27	25	25	23	23	22	22	22	22	22	21	20	20	20	19	302	511		
DSM, Class 2, WA	8	9	10	10	11	9	10	10	11	11	9	9	9	9	9	8	8	8	8	7	98	181		
DSM, Class 2 Total	54	50	47	44	42	38	36	36	36	35	32	32	32	32	33	30	29	29	28	27	417	722		
FOT COB Q3	-	92	148	113	268	268	-	268	39	21	268	268	268	268	214	268	268	26	268	217	122	177		
FOT MidColumbia Q3	400	400	400	400	400	400	400	400	400	400	400	400	400	400	400	400	400	400	400	400	400	400		
FOT MidColumbia Q3 - 2	227	375	375	375	375	375	355	375	375	375	375	375	375	375	375	375	375	375	375	375	375	367		
FOT NOB Q3	100	100	100	100	100	100	100	100	100	100	100	100	100	100	100	100	100	100	100	100	100	100		
Existing Plant Retirements/Conversions	(222)	-	-	57	(106)	-	-	(450)	-	(460)	(728)	-	-	(220)	(359)	(694)	(77)	-	(956)	-	-	-		
Annual Additions, Long Term Resources	133	147	146	146	153	243	139	164	574	675	557	135	136	559	611	544	123	577	778	533	-	-		
Annual Additions, Short Term Resources	727	967	1,023	988	1,152	1,178	855	1,294	914	896	1,290	1,327	1,390	1,343	1,133	1,443	1,435	1,201	1,443	1,392	-	-		
Total Annual Additions	860	1,114	1,169	1,134	1,305	1,421	994	1,458	1,488	1,571	1,847	1,462	1,526	1,902	1,744	1,987	1,558	1,777	2,221	1,925	-	-		

1/ Front office transaction amounts reflect one-year transaction periods, are not additive, and are reported as a 10/20-year annual average.

Case C14-1		Capacity (MW)																				Resource Totals 1/		
		2015	2016	2017	2018	2019	2020	2021	2022	2023	2024	2025	2026	2027	2028	2029	2030	2031	2032	2033	2034	10-year	20-year	
East	Existing Plant Retirements/Conversions																							
	Hayden 1	-	-	-	-	-	-	-	-	-	-	-	-	-	-	-	-	-	(45)	-	-	-	-	(45)
	Hayden 2	-	-	-	-	-	-	-	-	-	-	-	-	-	-	-	-	-	(33)	-	-	-	-	(33)
	Hunter 2 (Coal Early Retirement/Conversions)	-	-	-	-	-	-	-	-	-	-	-	-	-	-	-	-	-	-	-	(269)	-	-	(269)
	Huntington 2 (Coal Early Retirement/Conversions)	-	-	-	-	-	-	-	-	(450)	-	-	-	-	-	-	-	-	-	-	-	-	(450)	(450)
	Carbon 1 (Coal Early Retirement/Conversions)	(67)	-	-	-	-	-	-	-	-	-	-	-	-	-	-	-	-	-	-	-	-	(67)	(67)
	Carbon 2 (Coal Early Retirement/Conversions)	(105)	-	-	-	-	-	-	-	-	-	-	-	-	-	-	-	-	-	-	-	-	(105)	(105)
	Cholla 4 (Coal Early Retirement/Conversions)	-	-	-	-	-	-	-	-	-	-	(387)	-	-	-	-	-	-	-	-	-	-	-	(387)
	DaveJohnston 1 (Coal Early Retirement/Conversions)	-	-	-	-	(106)	-	-	-	-	-	-	-	-	-	-	-	-	-	-	-	-	(106)	(106)
	DaveJohnston 2	-	-	-	-	-	-	-	-	-	-	-	-	-	-	(106)	-	-	-	-	-	-	-	(106)
	DaveJohnston 3	-	-	-	-	-	-	-	-	-	-	-	-	-	-	(220)	-	-	-	-	-	-	-	(220)
	DaveJohnston 4	-	-	-	-	-	-	-	-	-	-	-	-	-	-	-	-	-	-	(330)	-	-	-	(330)
	Naughton 1	-	-	-	-	-	-	-	-	-	-	-	-	-	-	-	-	(156)	-	-	-	-	-	(156)
	Naughton 2	-	-	-	-	-	-	-	-	-	-	-	-	-	-	-	-	(201)	-	-	-	-	-	(201)
	Naughton 3 (Coal Early Retirement/Conversions)	(50)	-	-	(280)	-	-	-	-	-	-	-	-	-	-	-	-	-	-	-	-	-	(330)	(330)
	Gadsby 1-6	-	-	-	-	-	-	-	-	-	-	-	-	-	-	-	-	-	-	(358)	-	-	-	(358)
	Coal Ret_AZ - Gas RePower	-	-	-	-	-	-	-	-	-	-	387	-	-	-	-	-	-	-	-	-	-	-	387
	Coal Ret_WY - Gas RePower	-	-	-	337	-	-	-	-	-	-	-	-	-	-	-	-	(337)	-	-	-	-	337	-
	Expansion Resources																							
	CCCT - DJohns - F 1x1	-	-	-	-	-	-	-	-	-	-	-	-	-	-	-	-	-	-	313	-	-	-	313
	CCCT - Huntington - J 1x1	-	-	-	-	-	-	-	-	-	423	-	-	-	-	-	-	-	-	-	-	-	423	423
	CCCT - Naughton - J 1x1	-	-	-	-	-	-	-	-	-	-	-	-	-	-	-	-	401	-	-	-	-	-	401
	Total CCCT	-	-	-	-	-	-	-	-	-	423	-	-	-	-	-	-	401	-	-	313	-	423	1,137
	Modular-Nuclear-East	-	-	-	-	-	-	-	-	-	-	-	-	-	-	-	-	1,037	-	1,037	518	-	-	2,592
	Wind, DJohnston, 43	-	-	-	-	106	-	-	-	-	-	-	-	-	326	-	-	-	-	17	-	-	106	449
	Wind, UT, 31	-	-	-	-	-	-	-	-	-	-	-	-	-	-	-	250	-	-	-	-	-	-	250
	Total Wind	-	-	-	-	106	-	-	-	-	-	-	-	-	326	-	250	-	-	17	-	-	106	699
	Utility Solar - PV - East	-	-	-	-	-	-	-	-	-	-	-	-	599	151	-	-	-	-	-	-	-	-	750
	DSM, Class 1, UT-DLC-RES	-	-	-	-	-	-	-	-	-	-	-	-	-	-	-	-	-	-	4.9	-	-	-	4.9
	DSM, Class 1 Total	-	-	-	-	-	-	-	-	-	-	-	-	-	-	-	-	-	-	4.9	-	-	-	4.9
	DSM, Class 2, ID	5	5	6	6	7	5	6	6	6	6	5	6	6	5	5	5	5	4	4	4	4	57	107
	DSM, Class 2, UT	75	84	98	99	107	95	101	106	108	108	88	87	87	87	84	78	77	76	74	74	74	981	1,790
	DSM, Class 2, WY	7	9	11	14	16	14	15	16	17	18	15	15	15	16	16	16	16	17	17	17	17	137	298
	DSM, Class 2 Total	87	98	114	119	129	114	122	128	131	132	108	108	108	108	105	99	98	97	95	95	95	1,174	2,195
	FOT Mona Q3	-	-	-	-	-	-	-	-	61	26	-	44	44	69	188	44	294	-	-	-	-	9	38
Existing Plant Retirements/Conversions																								
JimBridger 1 (Coal Early Retirement/Conversions)	-	-	-	-	-	-	-	-	-	(354)	-	-	-	-	-	-	-	-	-	-	-	(354)	(354)	
JimBridger 2 (Coal Early Retirement/Conversions)	-	-	-	-	-	-	-	-	-	-	-	-	-	-	-	-	-	-	(359)	-	-	-	(359)	
Expansion Resources																								
Wind, YK, 29	-	-	-	-	-	-	-	-	-	-	-	-	-	-	-	-	151	-	-	-	-	-	151	
Total Wind	-	-	-	-	-	-	-	-	-	-	-	-	-	-	-	-	151	-	-	-	-	-	151	
Oregon Solar Capacity Standard	-	7	-	-	-	-	-	-	-	-	-	-	-	-	-	-	-	-	-	-	-	7	7	
DSM, Class 1, OR-Curtail	-	-	-	-	-	-	-	-	10.6	-	-	10.6	-	-	10.6	-	-	-	-	1.1	10.6	32.9		
DSM, Class 1, OR-Irrigate	-	-	-	-	-	-	-	5.0	-	-	-	-	-	-	-	-	-	-	-	0.3	5.0	5.3		
DSM, Class 1 Total	-	-	-	-	-	-	-	5.0	10.6	-	-	10.6	-	-	10.6	-	-	-	-	1.4	15.6	38.1		
DSM, Class 2, CA	2	2	2	2	2	2	2	2	2	2	2	2	2	2	2	2	1	1	2	2	2	19	34	
DSM, Class 2, OR	44	40	39	36	32	31	28	30	29	28	26	26	25	25	29	29	23	29	27	27	27	338	602	
DSM, Class 2, WA	9	11	12	11	12	10	11	11	12	12	10	10	10	10	10	8	8	8	8	8	8	113	202	
DSM, Class 2 Total	55	52	53	50	47	43	41	44	43	42	37	37	37	37	40	39	32	38	37	36	36	469	839	
FOT COB Q3	-	80	122	72	221	233	-	268	268	207	233	255	69	268	264	268	-	-	-	-	-	147	141	
FOT MidColumbia Q3	400	400	400	400	400	400	400	400	400	400	400	400	400	400	400	400	400	400	400	400	400	400	400	
FOT MidColumbia Q3 - 2	221	375	375	375	375	375	269	375	375	375	375	375	375	375	375	375	252	256	266	288	288	349	340	
FOT NOB Q3	100	100	100	100	100	100	100	100	100	100	100	100	100	100	100	100	100	100	100	100	100	100	100	
Existing Plant Retirements/Conversions	(222)	-	-	57	(106)	-	-	(450)	-	(354)	-	-	-	-	(326)	-	(694)	(77)	-	(1,316)	-	-	-	
Annual Additions, Long Term Resources	142	157	167	168	176	264	163	176	184	597	145	156	743	622	156	939	1,167	135	1,504	651	-	-		
Annual Additions, Short Term Resources	721	955	997	947	1,096	1,108	769	1,204	1,169	1,082	1,152	1,174	1,012	1,331	1,183	1,437	752	756	766	788	-	-		
Total Annual Additions	863	1,113	1,164	1,115	1,272	1,372	932	1,380	1,353	1,679	1,297	1,330	1,756	1,953	1,339	2,376	1,919	891	2,270	1,439	-	-		

1/ Front office transaction amounts reflect one-year transaction periods, are not additive, and are reported as a 10/20-year annual average.

Case C14-2		Capacity (MW)																				Resource Totals 1/																					
		2015	2016	2017	2018	2019	2020	2021	2022	2023	2024	2025	2026	2027	2028	2029	2030	2031	2032	2033	2034	10-year	20-year																				
East	Existing Plant Retirements/Conversions																																										
	Hayden 1	-	-	-	-	-	-	-	-	-	-	-	-	-	-	-	-	-	(45)	-	-	-	-	(45)																			
	Hayden 2	-	-	-	-	-	-	-	-	-	-	-	-	-	-	-	-	-	(33)	-	-	-	-	(33)																			
	Hunter 2 (Coal Early Retirement/Conversions)	-	-	-	-	-	-	-	-	-	-	-	-	-	-	-	-	-	-	-	-	-	-	(269)																			
	Huntington 1 (Coal Early Retirement/Conversions)	-	-	-	-	-	-	-	-	-	-	-	-	-	-	-	-	-	-	-	-	-	-	(459)																			
	Huntington 2 (Coal Early Retirement/Conversions)	-	-	-	-	-	-	-	-	-	(450)	-	-	-	-	-	-	-	-	-	-	-	-	(450)																			
	Carbon 1 (Coal Early Retirement/Conversions)	(67)	-	-	-	-	-	-	-	-	-	-	-	-	-	-	-	-	-	-	-	-	-	(67)																			
	Carbon 2 (Coal Early Retirement/Conversions)	(105)	-	-	-	-	-	-	-	-	-	-	-	-	-	-	-	-	-	-	-	-	-	(105)																			
	Cholla 4 (Coal Early Retirement/Conversions)	-	-	-	-	-	-	-	-	-	-	-	(387)	-	-	-	-	-	-	-	-	-	-	(387)																			
	DaveJohnston 1 (Coal Early Retirement/Conversions)	-	-	-	-	(106)	-	-	-	-	-	-	-	-	-	-	-	-	-	-	-	-	-	(106)																			
	DaveJohnston 2 (Coal Early Retirement/Conversions)	-	-	-	-	-	-	-	-	-	(106)	-	-	-	-	-	-	-	-	-	-	-	-	(106)																			
	DaveJohnston 3	-	-	-	-	-	-	-	-	-	-	-	-	-	-	(220)	-	-	-	-	-	-	-	(220)																			
	DaveJohnston 4	-	-	-	-	-	-	-	-	-	-	-	-	-	-	-	-	-	-	-	(330)	-	-	(330)																			
	Naughton 1	-	-	-	-	-	-	-	-	-	-	-	-	-	-	-	-	(156)	-	-	-	-	-	(156)																			
	Naughton 2	-	-	-	-	-	-	-	-	-	-	-	-	-	-	-	(201)	-	-	-	-	-	-	(201)																			
	Naughton 3 (Coal Early Retirement/Conversions)	(50)	-	-	(280)	-	-	-	-	-	-	-	-	-	-	-	-	-	-	-	-	-	-	(330)																			
	Wyodak (Coal Early Retirement/Conversions)	-	-	-	-	-	-	-	-	-	-	-	-	-	-	-	-	-	-	-	-	(268)	-	(268)																			
	Gadsby 1-6	-	-	-	-	-	-	-	-	-	-	-	-	-	-	-	-	-	-	-	-	-	(358)	(358)																			
	Coal Ret_AZ - Gas RePower	-	-	-	-	-	-	-	-	-	-	387	-	-	-	-	-	-	-	-	-	-	-	387																			
	Coal Ret_WY - Gas RePower	-	-	-	337	-	-	-	-	-	-	-	-	-	-	-	(337)	-	-	-	-	-	-	337																			
	Expansion Resources																																										
	CCCT - DJohns - F 1x1	-	-	-	-	-	-	-	-	-	-	-	-	-	-	-	-	-	-	-	313	-	-	313																			
	CCCT - Huntington - J 1x1	-	-	-	-	-	-	-	-	-	-	846	-	-	-	-	-	-	-	-	-	-	-	846																			
	CCCT - Naughton - J 1x1	-	-	-	-	-	-	-	-	-	-	-	-	-	-	-	-	401	-	-	-	-	-	401																			
	CCCT - Utah-S - J 1x1	-	-	-	-	-	-	-	-	-	-	423	-	-	-	-	-	-	-	-	-	-	-	423																			
	Total CCCT	-	-	-	-	-	-	-	-	-	-	423	846	-	-	-	-	401	-	-	-	313	-	423	1,983																		
	IC Aero WYD	-	-	-	-	-	-	-	-	-	-	-	-	-	-	-	-	-	-	-	-	83	-	83																			
	Modular-Nuclear-East	-	-	-	-	-	-	-	-	-	-	-	-	-	-	-	-	1,037	-	-	-	518	518	2,074																			
	Wind, DJohnston, 43	-	-	-	-	-	106	-	-	-	-	106	-	-	-	220	-	-	-	-	17	-	-	212	449																		
	Wind, WYAE, 43	-	-	-	-	-	-	-	-	-	-	-	-	-	-	-	-	299	-	-	-	426	2	-	727																		
	Total Wind	-	-	-	-	-	106	-	-	-	-	106	-	-	-	220	-	299	-	-	-	443	2	212	1,176																		
	Utility Solar - PV - East	-	-	-	-	-	-	-	-	-	-	-	-	-	431	146	-	-	-	-	-	-	-	577																			
	DSM, Class 1, WY-Curtail	-	-	-	-	-	-	-	-	-	-	-	-	-	-	-	-	-	-	-	-	45.8	-	45.8																			
	DSM, Class 1, WY-DLC-RES	-	-	-	-	-	-	-	-	-	-	-	-	-	-	-	-	-	-	-	-	5.0	-	5.0																			
	DSM, Class 1 Total	-	-	-	-	-	-	-	-	-	-	-	-	-	-	-	-	-	-	-	-	50.8	-	50.8																			
	DSM, Class 2, ID	5	5	6	6	7	5	6	6	6	6	6	6	6	5	5	5	5	4	4	4	4	4	57	107																		
	DSM, Class 2, UT	75	91	98	100	110	98	101	106	109	108	88	87	87	87	84	78	77	76	74	74	74	996	1,806																			
	DSM, Class 2, WY	7	9	11	14	16	14	15	17	17	18	15	15	16	16	16	16	16	17	17	17	17	137	300																			
	DSM, Class 2 Total	87	106	114	119	132	117	122	128	132	133	108	108	108	108	108	105	99	98	97	95	95	1,191	2,213																			
	FOT Mona Q3	-	-	-	-	-	-	-	49	12	10	44	46	75	176	299	299	-	-	-	-	-	-	7	50																		
	Existing Plant Retirements/Conversions																																										
	JimBridger 1 (Coal Early Retirement/Conversions)	-	-	-	-	-	-	-	-	-	-	(354)	-	-	-	-	-	-	-	-	-	-	-	(354)	(354)																		
	JimBridger 2 (Coal Early Retirement/Conversions)	-	-	-	-	-	-	-	-	-	-	-	-	-	-	-	(359)	-	-	-	-	-	-	-	(359)																		
	Expansion Resources																																										
Wind, WW, 29	-	-	-	-	-	-	-	-	-	-	-	-	-	-	-	-	-	314	-	-	-	-	314																				
Wind, YK, 29	-	-	-	-	-	-	-	-	-	-	-	-	-	-	-	-	-	400	-	-	-	-	400																				
Total Wind	-	-	-	-	-	-	-	-	-	-	-	-	-	-	-	-	-	714	-	-	-	-	714																				
Utility Solar - PV - West	-	-	-	-	-	-	-	-	-	-	-	-	-	-	-	225	307	-	-	-	-	-	532																				
Oregon Solar Capacity Standard	-	7	-	-	-	-	-	-	-	-	-	-	-	-	-	-	-	-	-	-	-	7	7																				
DSM, Class 1, OR-Curtail	-	-	-	-	-	-	-	-	10.6	-	-	10.6	-	-	-	-	10.6	-	-	-	-	1.1	10.6	32.9																			
DSM, Class 1, OR-Irrigate	-	-	-	-	-	-	-	5.0	-	-	3.4	-	-	-	-	-	-	-	-	-	-	0.3	5.0	8.7																			
DSM, Class 1 Total	-	-	-	-	-	-	-	5.0	10.6	-	3.4	10.6	-	-	-	-	10.6	-	-	-	-	1.4	15.6	41.5																			
DSM, Class 2, CA	2	2	2	2	2	2	2	2	2	2	2	2	2	2	2	2	2	1	1	2	2	2	19	35																			
DSM, Class 2, OR	45	40	39	36	32	31	29	30	29	28	26	26	32	32	32	29	23	29	27	27	27	338	620																				
DSM, Class 2, WA	9	10	12	11	12	11	11	11	12	12	10	10	10	10	10	8	8	8	8	8	8	113	203																				
DSM, Class 2 Total	56	52	53	50	47	43	41	44	43	42	37	37	44	44	43	39	33	38	37	36	36	470	858																				
FOT COB Q3	-	74	115	65	211	222	-	268	268	268	249	268	137	268	268	268	-	-	-	-	-	-	149	147																			
FOT MidColumbia Q3	400	400	400	400	400	400	400	400	400	400	400	400	400	400	400	400	400	400	400	400	400	400	400	400																			
FOT MidColumbia Q3 - 2	220	375	375	375	375	375	257	375	375	375	375	375	375	375	375	375	375	20	108	109	115	348	304																				
FOT NOB Q3	100	100	100	100	100	100	100	100	100	100	100	100	100	100	100	100	100	100	100	100	100	100	100	100																			
Existing Plant Retirements/Conversions																						(222)	-	-	57	(106)	-	-	(450)	-	(460)	(728)	-	-	(220)	(359)	(694)	(77)	-	(956)	-	-	-
Annual Additions, Long Term Resources																						143	165	167	169	179	267	163	177	186	704	994	156	583	519	374	1,869	1,167	135	1,540	653	-	-
Annual Additions, Short Term Resources																						720	949	990	940	1,086	1,097	757	1,192	1,155	1,153	1,168	1,189	1,087	1,319	1,442	1,442	520	608	609	615	-	-
Total Annual Additions																						863	1,113	1,157	1,109	1,265	1,363	920	1,368	1,341	1,857	2,162	1,345	1,669	1,837	1,815	3,311	1,687	743	2,149	1,268	-	-

1/ Front office transaction amounts reflect one-year transaction periods, are not additive, and are reported as a 10/20-year annual average.

Case C14a-1		Capacity (MW)																	Resource Totals 1/					
		2015	2016	2017	2018	2019	2020	2021	2022	2023	2024	2025	2026	2027	2028	2029	2030	2031	2032	2033	2034	10-year	20-year	
East	Existing Plant Retirements/Conversions																							
	Hayden 1	-	-	-	-	-	-	-	-	-	-	-	-	-	-	-	-	(45)	-	-	-	-	(45)	
	Hayden 2	-	-	-	-	-	-	-	-	-	-	-	-	-	-	-	-	(33)	-	-	-	-	(33)	
	Hunter 1 (Coal Early Retirement/Conversions)	-	-	-	-	-	-	(418)	-	-	-	-	-	-	-	-	-	-	-	-	-	(418)	(418)	
	Hunter 2 (Coal Early Retirement/Conversions)	-	-	-	-	-	-	-	-	-	-	-	-	-	-	-	-	-	-	(269)	-	-	(269)	
	Hunter 3 (Coal Early Retirement/Conversions)	-	-	-	-	-	-	-	-	-	(471)	-	-	-	-	-	-	-	-	-	-	-	(471)	(471)
	Huntington 2 (Coal Early Retirement/Conversions)	-	-	-	-	-	-	-	(450)	-	-	-	-	-	-	-	-	-	-	-	-	-	(450)	(450)
	Carbon 1 (Coal Early Retirement/Conversions)	(67)	-	-	-	-	-	-	-	-	-	-	-	-	-	-	-	-	-	-	-	-	(67)	(67)
	Carbon 2 (Coal Early Retirement/Conversions)	(105)	-	-	-	-	-	-	-	-	-	-	-	-	-	-	-	-	-	-	-	-	(105)	(105)
	Cholla 4 (Coal Early Retirement/Conversions)	-	-	-	-	-	-	-	-	-	-	(387)	-	-	-	-	-	-	-	-	-	-	-	(387)
	DaveJohnston 1 (Coal Early Retirement/Conversions)	-	-	-	-	(106)	-	-	-	-	-	-	-	-	-	-	-	-	-	-	-	-	(106)	(106)
	DaveJohnston 2	-	-	-	-	-	-	-	-	-	-	-	-	-	-	(106)	-	-	-	-	-	-	-	(106)
	DaveJohnston 3	-	-	-	-	-	-	-	-	-	-	-	-	-	-	(220)	-	-	-	-	-	-	-	(220)
	DaveJohnston 4	-	-	-	-	-	-	-	-	-	-	-	-	-	-	-	-	-	(330)	-	-	-	-	(330)
	Naughton 1	-	-	-	-	-	-	-	-	-	-	-	-	-	-	-	-	(156)	-	-	-	-	-	(156)
	Naughton 2	-	-	-	-	-	-	-	-	-	-	-	-	-	-	-	-	(201)	-	-	-	-	-	(201)
	Naughton 3 (Coal Early Retirement/Conversions)	(50)	-	-	(280)	-	-	-	-	-	-	-	-	-	-	-	-	-	-	-	-	-	(330)	(330)
	Cadaby 1-6	-	-	-	-	-	-	-	-	-	-	-	-	-	-	-	-	-	-	-	(358)	-	-	(358)
	Coal Ret_AZ - Gas RePower	-	-	-	-	-	-	-	-	-	-	-	387	-	-	-	-	-	-	-	-	-	-	387
	Coal Ret_WY - Gas RePower	-	-	-	337	-	-	-	-	-	-	-	-	-	-	-	-	(337)	-	-	-	-	-	337
	Expansion Resources																							
	CCCT - DJohns - F 1x1	-	-	-	-	-	-	-	-	-	-	-	-	-	-	-	-	-	-	-	313	-	-	313
	CCCT - Huntington - J 1x1	-	-	-	-	-	-	-	423	-	-	-	-	-	-	-	-	-	-	-	-	-	423	423
	CCCT - Naughton - J 1x1	-	-	-	-	-	-	-	-	-	-	-	-	-	-	-	-	401	-	-	-	-	-	401
	CCCT - Utah-S - J 1x1	-	-	-	-	-	-	-	-	-	846	-	-	-	-	-	-	-	-	-	-	-	-	846
	Total CCCT	-	-	-	-	-	-	-	423	-	846	-	-	-	-	-	-	401	-	-	313	-	1,269	1,983
	Modular-Nuclear-East	-	-	-	-	-	-	-	-	-	-	-	-	-	-	-	-	-	1,555	-	1,037	-	-	2,592
	Wind, DJohnston, 43	-	-	-	-	-	106	-	-	-	-	-	-	-	-	326	-	-	-	-	17	-	106	449
	Total Wind	-	-	-	-	-	106	-	-	-	-	-	-	-	-	326	-	-	-	-	17	-	106	449
	Utility Solar - PV - East	-	-	-	-	-	-	-	-	-	-	-	82	72	-	-	-	-	-	-	-	-	-	154
	DSM, Class 2, ID	5	5	6	6	7	5	6	6	6	7	6	6	6	5	5	5	5	5	4	4	4	58	108
	DSM, Class 2, UT	75	91	98	102	110	98	101	106	109	108	88	87	87	87	84	78	77	76	74	74	998	1,807	
	DSM, Class 2, WY	7	9	11	14	16	14	15	17	17	18	15	15	16	16	16	16	16	17	17	17	137	300	
	DSM, Class 2 Total	87	106	114	121	132	117	122	128	132	133	108	108	108	108	105	99	98	97	95	95	1,193	2,215	
	FOT Mona Q3	-	-	-	-	-	-	-	4	68	31	16	82	73	102	294	155	300	-	-	-	-	12	56
West	Existing Plant Retirements/Conversions																							
	JimBridger 1 (Coal Early Retirement/Conversions)	-	-	-	-	-	-	-	-	-	(354)	-	-	-	-	-	-	-	-	-	-	-	(354)	(354)
	JimBridger 2 (Coal Early Retirement/Conversions)	-	-	-	-	-	-	-	-	-	-	-	-	-	-	-	-	-	-	(359)	-	-	-	(359)
	Expansion Resources																							
	Wind, WW, 29	-	-	-	-	-	-	-	-	-	-	-	-	-	-	-	426	-	-	-	-	-	426	
	Wind, YK, 29	-	-	-	-	-	-	-	-	-	-	-	-	-	166	-	234	-	-	-	-	-	400	
	Total Wind	-	-	-	-	-	-	-	-	-	-	-	-	-	166	-	660	-	-	-	-	-	826	
	Utility Solar - PV - West	-	-	-	-	-	-	-	-	-	-	-	-	-	-	-	32	-	-	-	-	-	437	
	Oregon Solar Capacity Standard	-	7	-	-	-	-	-	-	-	-	-	-	-	-	-	-	-	-	-	-	7	7	
	DSM, Class 1, OR-Curtail	-	-	-	-	-	-	-	-	10.6	-	-	10.6	-	-	-	10.6	-	-	-	-	1.1	10.6	32.9
	DSM, Class 1, OR-Irrigate	-	-	-	-	-	-	-	5.0	-	-	3.4	-	-	-	-	-	-	-	-	-	0.3	5.0	8.7
	DSM, Class 1 Total	-	-	-	-	-	-	-	5.0	10.6	-	3.4	10.6	-	-	-	10.6	-	-	-	-	1.4	15.6	41.5
	DSM, Class 2, CA	2	2	2	2	2	2	2	2	2	2	2	2	2	2	2	2	2	1	1	1	1	19	35
	DSM, Class 2, OR	45	40	39	36	32	31	30	30	29	28	26	26	32	32	32	29	23	23	27	27	340	616	
	DSM, Class 2, WA	9	11	12	11	12	11	11	11	12	12	10	10	10	10	10	8	8	8	8	8	8	113	203
	DSM, Class 2 Total	56	52	53	50	47	43	43	44	43	42	37	37	44	44	43	39	32	33	37	36	472	854	
	FOT COB Q3	-	73	115	63	210	220	268	268	268	268	268	268	268	268	268	268	268	-	-	-	-	175	168
	FOT MidColumbia Q3	400	400	400	400	400	400	400	400	400	400	400	400	400	400	400	400	330	336	351	373	400	390	
	FOT MidColumbia Q3 - 2	220	375	375	375	375	375	375	375	375	375	375	375	375	375	375	375	-	-	-	-	360	292	
	FOT NOB Q3	100	100	100	100	100	100	100	100	100	100	100	100	100	100	100	100	100	100	100	100	100	100	100
	Existing Plant Retirements/Conversions	(222)	-	-	57	(106)	-	(418)	(450)	-	(825)	-	-	-	(326)	-	(694)	(77)	-	(1,316)	-	-	-	-
	Annual Additions, Long Term Resources	143	165	167	171	179	267	165	599	186	1,021	148	238	224	1,050	149	1,242	1,685	130	1,499	133	-	-	
Annual Additions, Short Term Resources	720	948	990	938	1,085	1,095	1,147	1,211	1,174	1,159	1,225	1,216	1,245	1,437	1,298	1,443	430	436	451	473	-	-		
Total Annual Additions	863	1,113	1,157	1,109	1,264	1,362	1,311	1,810	1,360	2,180	1,373	1,454	1,468	2,487	1,447	2,685	2,115	566	1,950	606	-	-		

1/ Front office transaction amounts reflect one-year transaction periods, are not additive, and are reported as a 10/20year annual average.

Case C14a-2		Capacity (MW)																			Resource Totals 1/		
		2015	2016	2017	2018	2019	2020	2021	2022	2023	2024	2025	2026	2027	2028	2029	2030	2031	2032	2033	2034	10-year	20-year
East	Existing Plant Retirements/Conversions																						
	Hayden 1	-	-	-	-	-	-	-	-	-	-	-	-	-	-	-	-	-	-	-	(45)	-	(45)
	Hayden 2	-	-	-	-	-	-	-	-	-	-	-	-	-	-	-	-	-	-	-	(33)	-	(33)
	Hunter 1 (Coal Early Retirement/Conversions)	-	-	-	-	-	-	-	-	-	-	-	-	-	-	-	-	-	-	-	-	-	(418)
	Hunter 2 (Coal Early Retirement/Conversions)	-	-	-	-	-	-	-	-	-	-	-	-	-	-	-	-	-	-	-	-	-	(269)
	Hunter 3 (Coal Early Retirement/Conversions)	-	-	-	-	-	-	-	-	-	-	-	-	-	-	-	-	-	-	-	-	-	(467)
	Huntington 1 (Coal Early Retirement/Conversions)	-	-	-	-	-	-	-	-	-	-	-	-	-	-	-	-	-	-	-	-	-	(459)
	Huntington 2 (Coal Early Retirement/Conversions)	-	-	-	-	-	-	-	-	-	-	-	-	-	-	-	-	-	-	-	-	-	(450)
	Carbon 1 (Coal Early Retirement/Conversions)	(67)	-	-	-	-	-	-	-	-	-	-	-	-	-	-	-	-	-	-	-	-	(67)
	Carbon 2 (Coal Early Retirement/Conversions)	(105)	-	-	-	-	-	-	-	-	-	-	-	-	-	-	-	-	-	-	-	-	(105)
	Cholla 4 (Coal Early Retirement/Conversions)	-	-	-	-	-	-	-	-	-	-	-	-	-	-	-	-	-	-	-	-	-	(387)
	DaveJohnston 1 (Coal Early Retirement/Conversions)	-	-	-	-	-	-	-	-	-	-	-	-	-	-	-	-	-	-	-	-	-	(106)
	DaveJohnston 2 (Coal Early Retirement/Conversions)	-	-	-	-	-	-	-	-	-	-	-	-	-	-	-	-	-	-	-	-	-	(106)
	DaveJohnston 3	-	-	-	-	-	-	-	-	-	-	-	-	-	-	-	-	-	-	-	-	-	(220)
	DaveJohnston 4	-	-	-	-	-	-	-	-	-	-	-	-	-	-	-	-	-	-	-	-	-	(330)
	Naughton 1	-	-	-	-	-	-	-	-	-	-	-	-	-	-	-	-	-	-	-	-	-	(156)
	Naughton 2	-	-	-	-	-	-	-	-	-	-	-	-	-	-	-	-	-	-	-	-	-	(201)
	Naughton 3 (Coal Early Retirement/Conversions)	(50)	-	-	-	-	-	-	-	-	-	-	-	-	-	-	-	-	-	-	-	-	(330)
	Wyodak (Coal Early Retirement/Conversions)	-	-	-	-	-	-	-	-	-	-	-	-	-	-	-	-	-	-	-	-	-	(268)
	Gadsby 1-6	-	-	-	-	-	-	-	-	-	-	-	-	-	-	-	-	-	-	-	-	-	(358)
	Coal Ret. AZ - Gas RePower	-	-	-	-	-	-	-	-	-	-	-	-	-	-	-	-	-	-	-	-	-	387
	Coal Ret. WY - Gas RePower	-	-	-	-	-	-	-	-	-	-	-	-	-	-	-	-	-	-	-	-	-	(337)
	Expansion Resources																						
	CCCT - DJohns - F 1x1	-	-	-	-	-	-	-	-	-	-	-	-	-	-	-	-	-	-	-	-	313	-
	CCCT - Huntington - J 1x1	-	-	-	-	-	-	-	-	423	-	-	423	-	-	-	-	-	-	-	-	-	423
	CCCT - Naughton - J 1x1	-	-	-	-	-	-	-	-	-	-	-	-	-	-	-	-	-	-	-	-	-	401
	CCCT - Utah-N - F 2x1	-	-	-	-	-	-	-	-	-	-	-	-	-	-	-	-	635	-	-	-	-	-
	CCCT - Utah-S - J 1x1	-	-	-	-	-	-	-	-	-	-	-	423	423	-	-	-	-	-	-	-	-	423
	Total CCCT	-	-	-	-	-	-	-	-	423	-	423	846	-	-	-	-	635	401	-	-	313	846
	IC Aero WYD	-	-	-	-	-	-	-	-	-	-	-	-	-	-	-	-	-	-	-	-	166	-
	Modular/Nuclear-East	-	-	-	-	-	-	-	-	-	-	-	-	-	-	-	-	-	1,555	-	-	518	-
	Wind, DJohnston, 43	-	-	-	-	-	-	-	-	-	-	-	106	-	-	-	-	-	-	-	-	17	-
	Wind, WYAE, 43	-	-	-	-	-	-	-	-	-	-	-	-	-	-	-	-	-	-	-	-	174	2
	Total Wind	-	-	-	-	-	-	-	-	-	-	-	106	-	-	-	-	-	-	-	-	191	2
	Utility Solar - PV - East	-	-	-	-	-	-	-	-	-	-	-	-	-	-	-	-	-	-	-	-	-	154
	DSM, Class 1, UT-DLC-RES	-	-	-	-	-	-	-	-	-	-	-	-	-	-	-	-	-	-	-	-	-	5.0
DSM, Class 1, WY-Curtail	-	-	-	-	-	-	-	-	-	-	-	-	-	-	-	-	-	-	-	-	-	45.8	
DSM, Class 1, WY-DLC-RES	-	-	-	-	-	-	-	-	-	-	-	-	-	-	-	-	-	-	-	-	-	5.0	
DSM, Class 1 Total	-	-	-	-	-	-	-	-	-	-	-	-	-	-	-	-	-	-	-	-	-	50.8	
DSM, Class 2, ID	5	5	6	6	7	5	6	6	6	6	7	6	6	6	5	5	5	5	5	5	5	4	
DSM, Class 2, UT	75	91	98	102	110	98	101	106	109	108	88	87	87	87	84	78	77	76	74	74	998	1,807	
DSM, Class 2, WY	7	9	11	14	16	14	15	17	17	18	15	15	16	16	16	16	17	17	17	17	138	300	
DSM, Class 2 Total	87	106	114	121	132	117	122	128	132	133	108	108	108	108	105	99	98	97	96	96	1,194	2,216	
FOT Mona Q3	-	-	-	-	-	-	-	-	2	66	30	27	65	63	61	298	44	237	-	-	-	13	
West																							
Existing Plant Retirements/Conversions																							
JimBridger 1 (Coal Early Retirement/Conversions)	-	-	-	-	-	-	-	-	-	-	-	-	-	-	-	-	-	-	-	-	-	(354)	
JimBridger 2 (Coal Early Retirement/Conversions)	-	-	-	-	-	-	-	-	-	-	-	-	-	-	-	-	-	-	-	-	-	(359)	
Expansion Resources																							
Wind, YK, 29	-	-	-	-	-	-	-	-	-	-	-	-	-	-	-	-	-	-	-	-	26	-	
Total Wind	-	-	-	-	-	-	-	-	-	-	-	-	-	-	-	-	-	-	-	-	26	-	
Utility Solar - PV - West	-	-	-	-	-	-	-	-	-	-	-	-	-	-	-	-	-	-	-	-	-	125	
Oregon Solar Capacity Standard	-	-	-	-	-	-	-	-	-	-	-	-	-	-	-	-	-	-	-	-	-	7	
DSM, Class 1, OR-Curtail	-	7	-	-	-	-	-	-	-	-	-	-	-	-	-	-	-	-	-	-	-	10.6	
DSM, Class 1, OR-Irrigate	-	-	-	-	-	-	-	-	-	-	-	5.0	-	-	-	-	-	-	-	-	-	5.0	
DSM, Class 1 Total	-	-	-	-	-	-	-	-	-	-	-	5.0	10.6	-	-	-	-	-	-	-	-	15.6	
DSM, Class 2, CA	2	2	2	2	2	2	2	2	2	2	2	2	2	2	2	2	2	2	2	2	1	1	
DSM, Class 2, OR	45	40	39	36	33	31	31	30	29	28	26	26	33	32	29	29	23	29	27	27	342	622	
DSM, Class 2, WA	9	11	12	11	12	11	11	12	12	12	10	10	10	10	8	8	8	8	8	8	114	204	
DSM, Class 2 Total	56	53	53	50	48	43	44	44	43	42	37	37	45	45	40	39	32	38	37	36	475	861	
FOT COB Q3	-	73	115	63	209	219	268	268	268	268	245	268	268	268	137	268	-	-	-	-	-	175	
FOT MidColumbia Q3	400	400	400	400	400	400	400	400	400	400	400	400	400	400	400	400	400	400	400	400	400	400	
FOT MidColumbia Q3 - 2	220	375	375	375	375	375	375	375	375	375	375	375	375	375	375	375	375	375	375	375	232	247	
FOT NOB Q3	100	100	100	100	100	100	100	100	100	100	100	100	100	100	100	100	100	100	100	100	100	100	
Existing Plant Retirements/Conversions	(222)	-	-	-	57	(106)	-	(418)	(450)	-	(460)	(728)	-	-	(220)	(359)	(694)	(544)	-	(956)	-	-	
Annual Additions, Long Term Resources	143	166	167	171	180	267	166	600	186	704	995	156	307	524	780	538	1,696	135	1,371	139	-		
Annual Additions, Short Term Resources	720	948	990	938	1,084	1,094	1,145	1,209	1,173	1,170	1,185	1,206	1,204	1,441	1,056	1,380	728	732	747	765	-		
Total Annual Additions	863	1,114	1,157	1,109	1,264	1,361	1,311	1,809	1,358	1,874	2,179	1,362	1,511	1,964	1,836	1,918	2,423	867	2,118	903	-		

1/ Front office transaction amounts reflect one-year transaction periods, are not additive, and are reported as a 10/20-year annual average.

Table K.8 – Sensitivity Cases, Detailed Capacity Expansion Portfolios

Case S-01		Capacity (MW)																				Resource Totals 1/			
		2015	2016	2017	2018	2019	2020	2021	2022	2023	2024	2025	2026	2027	2028	2029	2030	2031	2032	2033	2034	10-year	20-year		
East	Existing Plant Retirements/Conversions																								
	Hayden 1	-	-	-	-	-	-	-	-	-	-	-	-	-	-	-	-	-	-	(45)	-	-	-	-	(45)
	Hayden 2	-	-	-	-	-	-	-	-	-	-	-	-	-	-	-	-	-	-	(33)	-	-	-	-	(33)
	Hunter 2 (Coal Early Retirement/Conversions)	-	-	-	-	-	-	-	-	-	-	-	-	-	-	-	-	-	-	-	-	(269)	-	-	(269)
	Huntington 2 (Coal Early Retirement/Conversions)	-	-	-	-	-	-	-	(450)	-	-	-	-	-	-	-	-	-	-	-	-	-	-	-	(450)
	Carbon 1 (Coal Early Retirement/Conversions)	(67)	-	-	-	-	-	-	-	-	-	-	-	-	-	-	-	-	-	-	-	-	-	-	(67)
	Carbon 2 (Coal Early Retirement/Conversions)	(105)	-	-	-	-	-	-	-	-	-	-	-	-	-	-	-	-	-	-	-	-	-	-	(105)
	Cholla 4 (Coal Early Retirement/Conversions)	-	-	-	-	-	-	-	-	-	-	(387)	-	-	-	-	-	-	-	-	-	-	-	-	(387)
	DaveJohnston 1 (Coal Early Retirement/Conversions)	-	-	-	-	(106)	-	-	-	-	-	-	-	-	-	-	-	-	-	-	-	-	-	-	(106)
	DaveJohnston 2	-	-	-	-	-	-	-	-	-	-	-	-	-	(106)	-	-	-	-	-	-	-	-	-	(106)
	DaveJohnston 3	-	-	-	-	-	-	-	-	-	-	-	-	-	(220)	-	-	-	-	-	-	-	-	-	(220)
	DaveJohnston 4	-	-	-	-	-	-	-	-	-	-	-	-	-	-	-	-	-	-	(330)	-	-	-	-	(330)
	Naughton 1	-	-	-	-	-	-	-	-	-	-	-	-	-	-	-	(156)	-	-	-	-	-	-	-	(156)
	Naughton 2	-	-	-	-	-	-	-	-	-	-	-	-	-	-	-	(201)	-	-	-	-	-	-	-	(201)
	Naughton 3 (Coal Early Retirement/Conversions)	(50)	-	-	(280)	-	-	-	-	-	-	-	-	-	-	-	-	-	-	-	-	-	-	-	(330)
	Gadsby 1-6	-	-	-	-	-	-	-	-	-	-	-	-	-	-	-	-	-	-	(358)	-	-	-	-	(358)
	Coal Ret_AZ - Gas RePower	-	-	-	-	-	-	-	-	-	-	387	-	-	-	-	-	-	-	-	-	-	-	-	387
	Coal Ret_WY - Gas RePower	-	-	-	337	-	-	-	-	-	-	-	-	-	-	-	-	(337)	-	-	-	-	-	-	337
	Expansion Resources																								
	CCCT - DJohns - F 1xl	-	-	-	-	-	-	-	-	-	-	-	-	-	-	-	313	-	-	-	-	-	-	-	313
	CCCT - DJohns - J 1xl	-	-	-	-	-	-	-	-	-	-	-	-	-	-	-	-	-	-	-	423	-	-	-	423
	CCCT - Huntington - J 1xl	-	-	-	-	-	-	-	-	-	-	-	-	-	-	-	-	-	423	-	-	-	-	-	423
	CCCT - Naughton - J 1xl	-	-	-	-	-	-	-	-	-	-	-	-	-	-	-	-	-	-	-	401	-	-	-	401
	CCCT - Utah-N - F 2xl	-	-	-	-	-	-	-	-	-	-	-	-	-	-	-	-	-	-	-	-	-	635	-	635
	CCCT - Utah-S - J 1xl	-	-	-	-	-	-	-	-	-	-	-	-	-	-	-	-	423	-	-	-	423	-	-	846
	Total CCCT	-	-	-	-	-	-	-	-	-	-	-	-	-	-	-	313	-	846	-	-	1,247	635	-	3,041
	Wind, DJohnston, 43	-	-	-	-	-	25	-	-	-	-	-	-	-	-	-	-	-	-	-	-	-	-	-	25
	Total Wind	-	-	-	-	-	25	-	-	-	-	-	-	-	-	-	-	-	-	-	-	-	-	-	25
	Utility Solar - PV - East	-	-	-	-	-	154	-	-	-	-	-	-	-	-	-	-	-	-	-	-	-	-	-	154
	DSM, Class 2, ID	4	4	5	5	5	4	4	4	5	5	5	5	5	5	5	5	4	4	4	4	4	4	4	88
	DSM, Class 2, UT	69	78	84	86	92	81	84	90	94	93	77	81	80	80	70	66	65	65	63	64	850	1,560		
	DSM, Class 2, WY	6	8	10	12	14	12	13	14	15	16	13	13	14	15	14	14	15	15	15	15	121	262		
	DSM, Class 2 Total	79	90	99	102	111	97	101	108	113	114	94	99	98	99	88	84	84	84	82	83	1,015	1,910		
	FOT Mona Q3	-	-	-	-	-	-	-	-	-	-	54	82	125	252	104	64	44	146	300	75	-	-	62	
	Existing Plant Retirements/Conversions																								
JimBridger 1 (Coal Early Retirement/Conversions)	-	-	-	-	-	-	-	-	-	-	(354)	-	-	-	-	-	-	-	-	-	-	-	-	(354)	
JimBridger 2 (Coal Early Retirement/Conversions)	-	-	-	-	-	-	-	-	-	-	-	-	-	-	-	-	-	-	-	(359)	-	-	-	(359)	
Expansion Resources																									
Wind, YK, 29	-	-	-	-	-	-	21	-	-	-	-	-	-	-	-	-	-	-	-	-	-	-	-	21	
Total Wind	-	-	-	-	-	21	-	-	-	-	-	-	-	-	-	-	-	-	-	-	-	-	-	21	
Oregon Solar Capacity Standard	-	7	-	-	-	-	-	-	-	-	-	-	-	-	-	-	-	-	-	-	-	-	-	7	
DSM, Class 1, OR-Curtail	-	-	-	-	-	-	-	-	-	-	-	-	-	-	-	-	-	-	10.6	-	-	-	-	10.6	
DSM, Class 1, OR-Irrigate	-	-	-	-	-	-	-	-	-	-	-	3.4	-	-	-	5.0	-	-	-	-	-	-	-	8.4	
DSM, Class 1 Total	-	-	-	-	-	-	-	-	-	-	-	3.4	-	-	-	5.0	10.6	-	-	-	-	-	-	19.0	
DSM, Class 2, CA	1	2	2	2	2	1	1	2	2	2	1	1	1	1	1	1	1	1	1	1	1	1	1	16	
DSM, Class 2, OR	44	39	36	32	29	27	25	25	24	23	21	22	22	22	20	19	19	20	19	19	303	505			
DSM, Class 2, WA	8	9	10	10	11	9	10	10	11	11	9	9	9	9	8	7	8	8	7	7	98	178			
DSM, Class 2 Total	54	49	47	44	42	38	36	36	36	35	31	32	32	32	29	28	28	29	27	27	417	712			
FOT COB Q3	-	-	-	-	-	-	-	-	-	266	268	268	268	268	268	221	211	268	195	140	27	132			
FOT MidColumbia Q3	400	400	400	400	400	400	400	400	400	400	400	400	400	400	400	400	400	400	400	400	400	400	400	400	
FOT MidColumbia Q3 - 2	122	297	328	168	317	276	214	374	359	375	375	375	375	375	375	375	375	375	375	375	375	375	283		
FOT NOB Q3	100	100	100	100	100	100	100	100	100	100	100	100	100	100	100	100	100	100	100	100	100	100	100		
Existing Plant Retirements/Conversions	(222)	-	-	57	(106)	-	-	(450)	-	(354)	-	-	-	(326)	-	(694)	(77)	-	(1,316)	-	-	-	-		
Annual Additions, Long Term Resources	133	146	146	146	153	314	158	144	149	149	125	134	130	445	117	963	122	113	1,356	745	-	-	-		
Annual Additions, Short Term Resources	622	797	828	668	817	776	714	874	859	1,141	1,197	1,225	1,268	1,394	1,247	1,160	1,130	1,289	1,370	1,090	-	-	-		
Total Annual Additions	755	943	974	814	969	1,090	872	1,019	1,009	1,290	1,322	1,359	1,398	1,840	1,364	2,123	1,252	1,402	2,727	1,834	-	-	-		

1/ Front office transaction amounts reflect one-year transaction periods, are not additive, and are reported as a 10/20-year annual average.

Case S-02		Capacity (MW)																			Resource Totals 1/				
		2015	2016	2017	2018	2019	2020	2021	2022	2023	2024	2025	2026	2027	2028	2029	2030	2031	2032	2033	2034	10-year	20-year		
East	Existing Plant Retirements/Conversions																								
	Hayden 1	-	-	-	-	-	-	-	-	-	-	-	-	-	-	-	-	-	(45)	-	-	-	(45)		
	Hayden 2	-	-	-	-	-	-	-	-	-	-	-	-	-	-	-	-	-	(33)	-	-	-	(33)		
	Hunter 2 (Coal Early Retirement/Conversions)	-	-	-	-	-	-	-	-	-	-	-	-	-	-	-	-	-	-	-	(269)	-	(269)		
	Huntington 2 (Coal Early Retirement/Conversions)	-	-	-	-	-	-	-	-	(450)	-	-	-	-	-	-	-	-	-	-	-	-	(450)	(450)	
	Carbon 1 (Coal Early Retirement/Conversions)	(67)	-	-	-	-	-	-	-	-	-	-	-	-	-	-	-	-	-	-	-	-	(67)	(67)	
	Carbon 2 (Coal Early Retirement/Conversions)	(105)	-	-	-	-	-	-	-	-	-	-	-	-	-	-	-	-	-	-	-	-	(105)	(105)	
	Cholla 4 (Coal Early Retirement/Conversions)	-	-	-	-	-	-	-	-	-	-	-	(387)	-	-	-	-	-	-	-	-	-	-	(387)	
	DaveJohnston 1 (Coal Early Retirement/Conversions)	-	-	-	-	(106)	-	-	-	-	-	-	-	-	-	-	-	-	-	-	-	-	(106)	(106)	
	DaveJohnston 2	-	-	-	-	-	-	-	-	-	-	-	-	-	-	(106)	-	-	-	-	-	-	-	(106)	
	DaveJohnston 3	-	-	-	-	-	-	-	-	-	-	-	-	-	-	(220)	-	-	-	-	-	-	-	(220)	
	DaveJohnston 4	-	-	-	-	-	-	-	-	-	-	-	-	-	-	-	-	-	-	(330)	-	-	-	(330)	
	Naughton 1	-	-	-	-	-	-	-	-	-	-	-	-	-	-	-	(156)	-	-	-	-	-	-	(156)	
	Naughton 2	-	-	-	-	-	-	-	-	-	-	-	-	-	-	-	(201)	-	-	-	-	-	-	(201)	
	Naughton 3 (Coal Early Retirement/Conversions)	(50)	-	-	(280)	-	-	-	-	-	-	-	-	-	-	-	-	-	-	-	-	(330)	(330)		
	Gadsby 1-6	-	-	-	-	-	-	-	-	-	-	-	-	-	-	-	-	-	-	(358)	-	-	-	(358)	
	Coal Ret. AZ - Gas RePower	-	-	-	-	-	-	-	-	-	-	-	387	-	-	-	-	-	-	-	-	-	-	387	
	Coal Ret. WY - Gas RePower	-	-	-	337	-	-	-	-	-	-	-	-	-	-	-	(337)	-	-	-	-	-	337	-	
	Expansion Resources																								
	CCCT - DJohns - F 1x1	-	-	-	-	-	-	-	-	-	-	-	-	-	-	313	-	-	-	-	-	-	-	313	
	CCCT - DJohns - J 1x1	-	-	-	-	-	-	-	-	-	-	-	-	-	-	-	-	-	-	423	-	-	-	423	
	CCCT - Huntington - J 1x1	-	-	-	-	-	-	-	-	-	423	-	-	-	-	-	-	-	-	-	-	-	423	423	
	CCCT - Naughton - J 1x1	-	-	-	-	-	-	-	-	-	-	-	-	-	-	-	-	401	-	-	-	-	-	401	
	CCCT - Utah-N - F 2x1	-	-	-	-	-	-	-	-	-	-	-	-	-	-	-	635	-	-	635	-	-	-	1,270	
	CCCT - Utah-N - J 1x1	-	-	-	-	-	-	-	-	-	-	-	-	-	-	-	-	-	-	-	423	-	-	423	
	CCCT - Utah-S - J 1x1	-	-	-	-	-	423	-	-	-	-	-	-	423	-	-	-	-	-	-	-	-	423	846	
	Total CCCT	-	-	-	-	-	423	-	-	-	423	-	-	423	313	-	635	401	-	1,058	423	846	4,099		
	Wind, DJohnston, 43	-	-	-	-	-	25	-	-	-	-	-	-	-	-	-	-	-	-	-	-	-	25	25	
	Total Wind	-	-	-	-	-	25	-	-	-	-	-	-	-	-	-	-	-	-	-	-	-	25	25	
	Utility Solar - PV - East	-	-	-	-	-	154	-	-	-	-	-	-	-	-	-	-	-	-	-	-	154	154		
	DSM, Class 1, UT-DLC-RES	-	-	-	-	-	-	-	-	-	-	-	-	-	-	-	-	-	-	4.9	-	-	-	4.9	
	DSM, Class 1 Total	-	-	-	-	-	-	-	-	-	-	-	-	-	-	-	-	-	-	4.9	-	-	-	4.9	
	DSM, Class 2, ID	4	4	5	5	5	4	4	4	5	6	5	5	5	5	5	4	4	4	4	4	4	4	46	91
	DSM, Class 2, UT	69	78	84	86	92	83	86	93	94	97	81	81	80	80	79	73	72	73	71	73	861	1,622		
	DSM, Class 2, WY	7	8	10	12	14	12	13	14	15	16	13	13	14	14	14	15	15	16	16	17	122	269		
	DSM, Class 2 Total	80	90	99	102	111	99	103	112	114	119	99	99	98	99	97	92	92	93	91	94	1,029	1,982		
	FOT Mona Q3	-	-	20	12	203	-	-	152	167	114	212	258	44	137	64	139	44	75	300	282	67	111		
Existing Plant Retirements/Conversions																									
JimBridger 1 (Coal Early Retirement/Conversions)	-	-	-	-	-	-	-	-	-	(354)	-	-	-	-	-	-	-	-	-	-	-	(354)	(354)		
JimBridger 2 (Coal Early Retirement/Conversions)	-	-	-	-	-	-	-	-	-	-	-	-	-	-	-	-	-	-	(359)	-	-	-	(359)		
Expansion Resources																									
Wind, YK, 29	-	-	-	-	-	-	-	-	24	-	-	-	-	-	-	-	-	-	-	-	-	24	24		
Total Wind	-	-	-	-	-	-	-	-	24	-	-	-	-	-	-	-	-	-	-	-	-	24	24		
Oregon Solar Capacity Standard	-	7	-	-	-	-	-	-	-	-	-	-	-	-	-	-	-	-	-	-	-	7	7		
DSM, Class 1, OR-Curtail	-	-	-	-	-	-	-	-	-	-	-	10.6	-	-	-	10.6	10.6	-	-	-	-	-	31.8		
DSM, Class 1, OR-Irrigate	-	-	-	-	-	-	-	-	-	5.0	3.4	-	-	-	-	-	-	-	-	-	5.0	8.4			
DSM, Class 1 Total	-	-	-	-	-	-	-	-	-	5.0	3.4	10.6	-	-	-	10.6	10.6	-	-	-	-	5.0	40.2		
DSM, Class 2, CA	1	2	2	2	2	1	1	2	2	2	1	1	1	1	1	1	1	1	1	1	1	16	29		
DSM, Class 2, OR	44	39	35	32	29	27	25	25	24	23	22	22	22	22	21	20	20	21	20	19	303	511			
DSM, Class 2, WA	8	9	10	10	11	9	10	10	11	11	9	9	9	9	8	8	8	8	8	7	99	181			
DSM, Class 2 Total	54	50	47	45	42	38	36	36	36	35	32	32	32	31	29	29	30	28	28	28	418	721			
FOT COB Q3	-	200	268	268	268	228	-	268	268	268	268	268	203	268	225	268	14	169	199	182	203	205			
FOT MidColumbia Q3	400	400	400	400	400	400	400	400	400	400	400	400	400	400	400	400	400	400	400	400	400	400			
FOT MidColumbia Q3 - 2	335	375	375	375	375	375	309	375	375	375	375	375	375	375	375	375	375	375	375	375	375	364	370		
FOT NOB Q3	100	100	100	100	100	100	100	100	100	100	100	100	100	100	100	100	100	100	100	100	100	100			
Existing Plant Retirements/Conversions																									
Annual Additions, Long Term Resources	134	147	146	147	153	739	139	147	174	582	134	141	553	444	128	767	533	123	1,183	545					
Annual Additions, Short Term Resources	835	1,075	1,163	1,155	1,346	1,103	809	1,295	1,310	1,257	1,355	1,401	1,122	1,280	1,163	1,281	933	1,119	1,374	1,339					
Total Annual Additions	969	1,222	1,310	1,302	1,498	1,842	948	1,443	1,484	1,839	1,488	1,543	1,675	1,724	1,292	2,048	1,466	1,241	2,557	1,884					

1/ Front office transaction amounts reflect one-year transaction periods, are not additive, and are reported as a 10/20-year annual average.

Case S-03		Capacity (MW)																			Resource Totals 1/										
		2015	2016	2017	2018	2019	2020	2021	2022	2023	2024	2025	2026	2027	2028	2029	2030	2031	2032	2033	2034	10-year	20-year								
East	Existing Plant Retirements/Conversions																														
	Hayden 1	-	-	-	-	-	-	-	-	-	-	-	-	-	-	-	-	-	-	(45)	-	-	-	-	-	-	-	-	(45)		
	Hayden 2	-	-	-	-	-	-	-	-	-	-	-	-	-	-	-	-	-	-	(33)	-	-	-	-	-	-	-	-	-	(33)	
	Hunter 2 (Coal Early Retirement/Conversions)	-	-	-	-	-	-	-	-	-	-	-	-	-	-	-	-	-	-	-	-	-	(269)	-	-	-	-	-	-	(269)	
	Huntington 2 (Coal Early Retirement/Conversions)	-	-	-	-	-	-	-	-	(450)	-	-	-	-	-	-	-	-	-	-	-	-	-	-	-	-	-	(450)	(450)		
	Carbon 1 (Coal Early Retirement/Conversions)	(67)	-	-	-	-	-	-	-	-	-	-	-	-	-	-	-	-	-	-	-	-	-	-	-	-	-	-	(67)	(67)	
	Carbon 2 (Coal Early Retirement/Conversions)	(105)	-	-	-	-	-	-	-	-	-	-	-	-	-	-	-	-	-	-	-	-	-	-	-	-	-	-	(105)	(105)	
	Cholla 4 (Coal Early Retirement/Conversions)	-	-	-	-	-	-	-	-	-	-	-	(387)	-	-	-	-	-	-	-	-	-	-	-	-	-	-	-	-	(387)	
	DaveJohnston 1 (Coal Early Retirement/Conversions)	-	-	-	-	(106)	-	-	-	-	-	-	-	-	-	-	-	-	-	-	-	-	-	-	-	-	-	-	(106)	(106)	
	DaveJohnston 2	-	-	-	-	-	-	-	-	-	-	-	-	-	-	-	-	-	-	-	-	-	-	-	-	-	-	-	-	(106)	
	DaveJohnston 3	-	-	-	-	-	-	-	-	-	-	-	-	-	-	-	-	(106)	-	-	-	-	-	-	-	-	-	-	-	(220)	
	DaveJohnston 4	-	-	-	-	-	-	-	-	-	-	-	-	-	-	-	-	-	-	-	-	-	(330)	-	-	-	-	-	-	(330)	
	Naughton 1	-	-	-	-	-	-	-	-	-	-	-	-	-	-	-	-	-	-	-	(156)	-	-	-	-	-	-	-	-	(156)	
	Naughton 2	-	-	-	-	-	-	-	-	-	-	-	-	-	-	-	-	-	(201)	-	-	-	-	-	-	-	-	-	-	(201)	
	Naughton 3 (Coal Early Retirement/Conversions)	(50)	-	-	(280)	-	-	-	-	-	-	-	-	-	-	-	-	-	-	-	-	-	-	-	-	-	-	(330)	(330)		
	Gadsby 1-6	-	-	-	-	-	-	-	-	-	-	-	-	-	-	-	-	-	-	-	-	-	-	-	-	-	(358)	-	-	(358)	
	Coal Ret. AZ - Gas RePower	-	-	-	-	-	-	-	-	-	-	-	-	387	-	-	-	-	-	-	-	-	-	-	-	-	-	-	-	387	
	Coal Ret. WY - Gas RePower	-	-	-	337	-	-	-	-	-	-	-	-	-	-	-	-	-	(337)	-	-	-	-	-	-	-	-	-	337	-	
	Expansion Resources																														
		CCCT - DJohns - F 1xl	-	-	-	-	-	-	-	-	-	-	-	-	-	-	-	313	-	-	-	-	-	-	-	-	-	-	-	313	
		CCCT - DJohns - J 1xl	-	-	-	-	-	-	-	-	-	-	-	-	-	-	-	-	-	-	-	-	423	-	-	-	-	-	-	423	
		CCCT - Huntington - F 1xl	-	-	-	-	-	-	-	-	313	-	-	-	-	-	-	-	-	-	-	-	-	-	-	-	-	-	313	313	
		CCCT - Naughton - J 1xl	-	-	-	-	-	-	-	-	-	-	-	-	-	-	-	-	-	-	-	-	-	-	-	-	-	-	401	401	
		CCCT - Utah-N - F2xl	-	-	-	-	-	-	-	-	-	-	-	-	-	-	-	-	-	-	-	-	-	-	1,270	-	-	-	1,270		
		CCCT - Utah-S - J 1xl	-	-	-	-	-	-	-	-	-	-	423	-	-	-	-	-	423	-	-	-	-	-	-	-	-	-	423	846	
		Total CCCT	-	-	-	-	-	-	-	313	-	423	-	-	-	-	313	-	824	-	-	-	-	-	1,693	-	-	-	736	3,567	
		Wind, DJohnston, 43	-	-	-	-	-	25	-	-	-	-	-	-	-	-	-	-	-	-	-	-	-	-	-	-	-	25	25		
		Total Wind	-	-	-	-	-	25	-	-	-	-	-	-	-	-	-	-	-	-	-	-	-	-	-	-	-	25	25		
		Utility Solar - PV - East	-	-	-	-	-	154	-	-	-	-	-	-	-	-	-	-	-	-	-	-	-	-	-	-	-	154	154		
		DSM, Class 1, ID-Irrigate	-	3.5	-	-	-	-	-	-	-	-	-	-	-	-	-	-	-	-	-	-	-	-	-	-	-	-	3.5	3.5	
		DSM, Class 1, UT-DLC-RES	-	5.3	-	-	-	-	-	-	-	-	-	-	-	-	-	-	-	-	-	-	-	-	-	-	-	-	5.3	5.3	
	DSM, Class 1, UT-Irrigate	-	6.5	-	-	-	-	-	-	-	-	-	-	-	-	-	-	-	-	-	-	-	-	-	-	-	-	6.5	6.5		
	DSM, Class 1 Total	-	15.4	-	-	-	-	-	-	-	-	-	-	-	-	-	-	-	-	-	-	-	-	-	-	-	-	15.4	15.4		
	DSM, Class 2, ID	8	9	6	6	7	5	4	4	5	5	5	5	5	5	5	5	4	4	4	4	4	4	4	4	4	4	59	104		
	DSM, Class 2, UT	127	136	100	102	109	93	86	90	91	93	78	81	80	80	81	75	74	75	73	64						1,026	1,786			
	DSM, Class 2, WY	12	15	10	12	15	12	13	14	15	16	13	13	14	14	15	15	15	16	17	15						136	283			
	DSM, Class 2 Total	147	160	116	120	130	111	103	108	110	114	95	99	98	99	100	94	94	96	94	83						1,220	2,172			
	Battery Storage - East	-	8.0	-	-	-	-	-	-	-	-	-	-	-	-	-	-	-	-	-	-	-	-	-	-	-	8	8			
	FOT Mona Q3	-	200	233	188	265	236	-	112	50	38	144	164	164	231	232	242	243	300	298	223						132	178			
West	Existing Plant Retirements/Conversions																														
	JimBridger 1 (Coal Early Retirement/Conversions)	-	-	-	-	-	-	-	-	-	-	-	(354)	-	-	-	-	-	-	-	-	-	-	-	-	-	-	(354)	(354)		
	JimBridger 2 (Coal Early Retirement/Conversions)	-	-	-	-	-	-	-	-	-	-	-	-	-	-	-	-	-	-	-	-	-	-	-	-	-	(359)	-	(359)		
	Expansion Resources																														
		IC Aero WV	-	-	-	-	101	-	-	-	-	-	-	-	-	-	-	-	-	-	-	-	-	-	-	-	-	101	101		
		Wind, YK, 29	-	-	-	-	-	-	-	13	-	-	-	-	-	-	-	-	-	-	-	-	-	-	-	-	-	13	13		
		Total Wind	-	-	-	-	-	-	-	13	-	-	-	-	-	-	-	-	-	-	-	-	-	-	-	-	-	13	13		
		Oregon Solar Capacity Standard	-	7	-	-	-	-	-	-	-	-	-	-	-	-	-	-	-	-	-	-	-	-	-	-	-	7	7		
		DSM, Class 1, OR-Curtail	-	-	10.6	-	-	-	-	-	-	-	-	-	-	-	-	-	-	-	-	-	-	-	-	-	-	10.6	10.6		
		DSM, Class 1, OR-DLC-RES	-	-	-	-	-	-	-	-	-	-	-	-	-	-	-	-	-	-	-	-	-	-	-	-	-	-	3.7		
		DSM, Class 1, OR-Irrigate	-	-	-	-	-	-	-	-	-	-	3.4	-	-	-	-	-	-	-	-	-	-	-	-	-	-	-	3.4		
		DSM, Class 1 Total	-	-	10.6	-	-	-	-	-	-	-	3.4	-	-	-	-	-	-	-	-	-	-	-	-	-	-	-	14.0	17.8	
		DSM, Class 2, CA	3	3	2	2	2	1	1	2	2	2	1	1	1	1	1	1	1	1	1	1	1	1	1	1	1	21	34		
		DSM, Class 2, OR	58	56	37	34	31	27	25	25	23	23	22	22	22	22	21	20	21	21	20	19						339	547		
		DSM, Class 2, WA	17	17	11	10	11	9	10	10	11	11	9	9	9	9	8	8	8	8	8	7						116	200		
		DSM, Class 2 Total	78	77	50	47	45	38	36	36	36	35	32	32	32	32	31	30	30	30	28	27						476	781		
		Battery Storage - West	-	10	-	-	-	-	-	-	-	-	-	-	-	-	-	-	-	-	-	-	-	-	-	-	-	10	10		
		Geothermal, Greenfield - West	-	30	-	-	-	-	-	-	-	-	-	-	-	-	-	-	-	-	-	-	-	-	-	-	-	30	30		
		FOT COB Q3	315	268	268	268	268	268	175	268	268	268	268	268	268	268	268	268	268	268	225	268	251				263	263			
		FOT MidColumbia Q3	400	400	400	400	400	400	400	400	400	400	400	400	400	400	400	400	400	400	400	400	400	400	400	400	400	400	400	400	
		FOT MidColumbia Q3 - 2	375	375	375	375	375	375	375	375	375	375	375	375	375	375	375	375	375	375	375	375	375	375	375	375	375	375	375	375	
		FOT NOB Q3	100	100	100	100	100	100	100	100	100	100	100	100	100	100	100	100	100	100	100	100	100	100	100	100	100	100	100	100	
	Existing Plant Retirements/Conversions		(222)	-	-	57	(106)	-	-	(450)	-	(354)	-	-	-	-	(326)	-	(694)	(77)	-	(1,316)	-								
	Annual Additions, Long Term Resources		225	307	176	166	276	328	139	471	146	576	127	131	131	444	132	951	124	126	1,815	110									
	Annual Additions, Short Term Resources		1,190	1,343	1,376	1,331	1,408	1,379	1,050	1,255	1,193	1,181	1,287	1,307	1,307	1,374	1,374	1,385	1,386	1,400	1,441	1,349									
	Total Annual Additions		1,415	1,650	1,551	1,498	1,684	1,706	1,189	1,726	1,339	1,757	1,414	1,438	1,438	1,819	1,506	2,337	1,510	1,526	3,256	1,459									

1/ Front office transaction amounts reflect one-year transaction periods, are not additive, and are reported as a 1

Case S-04	Capacity (MW)																				Resource Totals 1/				
	2015	2016	2017	2018	2019	2020	2021	2022	2023	2024	2025	2026	2027	2028	2029	2030	2031	2032	2033	2034	10-year	20-year			
East	Existing Plant Retirements/Conversions																								
	Hayden 1	-	-	-	-	-	-	-	-	-	-	-	-	-	-	-	-	(45)	-	-	-	-	(45)		
	Hayden 2	-	-	-	-	-	-	-	-	-	-	-	-	-	-	-	-	(33)	-	-	-	-	(33)		
	Hunter 2 (Coal Early Retirement/Conversions)	-	-	-	-	-	-	-	-	-	-	-	-	-	-	-	-	-	-	(269)	-	-	(269)		
	Huntington 2 (Coal Early Retirement/Conversions)	-	-	-	-	-	-	-	(450)	-	-	-	-	-	-	-	-	-	-	-	-	-	(450)	(450)	
	Carbon 1 (Coal Early Retirement/Conversions)	(67)	-	-	-	-	-	-	-	-	-	-	-	-	-	-	-	-	-	-	-	-	(67)	(67)	
	Carbon 2 (Coal Early Retirement/Conversions)	(105)	-	-	-	-	-	-	-	-	-	-	-	-	-	-	-	-	-	-	-	-	(105)	(105)	
	Cholla 4 (Coal Early Retirement/Conversions)	-	-	-	-	-	-	-	-	-	(387)	-	-	-	-	-	-	-	-	-	-	-	-	(387)	
	DaveJohnston 1 (Coal Early Retirement/Conversions)	-	-	-	-	(106)	-	-	-	-	-	-	-	-	-	-	-	-	-	-	-	-	(106)	(106)	
	DaveJohnston 2	-	-	-	-	-	-	-	-	-	-	-	-	-	(106)	-	-	-	-	-	-	-	-	(106)	
	DaveJohnston 3	-	-	-	-	-	-	-	-	-	-	-	-	-	(220)	-	-	-	-	-	-	-	-	(220)	
	DaveJohnston 4	-	-	-	-	-	-	-	-	-	-	-	-	-	-	-	-	-	-	(330)	-	-	-	(330)	
	Naughton 1	-	-	-	-	-	-	-	-	-	-	-	-	-	-	-	(156)	-	-	-	-	-	-	(156)	
	Naughton 2	-	-	-	-	-	-	-	-	-	-	-	-	-	-	-	(201)	-	-	-	-	-	-	(201)	
	Naughton 3 (Coal Early Retirement/Conversions)	(50)	-	-	(280)	-	-	-	-	-	-	-	-	-	-	-	-	-	-	-	-	-	(330)	(330)	
	Gadsby 1-6	-	-	-	-	-	-	-	-	-	-	-	-	-	-	-	-	-	-	(358)	-	-	-	(358)	
	Coal Ret. AZ - Gas RePower	-	-	-	-	-	-	-	-	-	-	387	-	-	-	-	-	-	-	-	-	-	-	387	
	Coal Ret. WY - Gas RePower	-	-	-	337	-	-	-	-	-	-	-	-	-	-	-	(337)	-	-	-	-	-	-	337	
	Expansion Resources																								
	CCCT - DJohns - F 1xl	-	-	-	-	-	-	-	-	-	-	-	-	-	313	-	-	-	-	-	-	-	-	313	
	CCCT - DJohns - J 1xl	-	-	-	-	-	-	-	-	-	-	-	-	-	-	-	-	-	-	423	-	-	-	423	
	CCCT - Huntington - J 1xl	-	-	-	-	-	-	-	-	-	-	423	-	-	-	-	-	-	-	-	-	-	-	423	
	CCCT - Naughton - J 1xl	-	-	-	-	-	-	-	-	-	-	-	-	-	-	-	401	-	-	-	-	-	-	401	
	CCCT - Utah-N - F 2xl	-	-	-	-	-	-	-	-	-	-	-	-	-	-	-	-	-	-	1,270	-	-	-	1,270	
	CCCT - Utah-S - J 1xl	-	-	-	-	-	-	-	-	423	-	-	-	-	-	-	-	423	-	-	-	-	-	423	
	Total CCCT	-	-	-	-	-	-	-	-	423	-	423	-	313	-	-	824	-	-	1,693	-	-	-	423	3,676
	Wind, DJohnston, 43	-	-	-	-	-	25	-	-	-	-	-	-	-	-	-	-	-	-	-	-	-	-	25	25
	Total Wind	-	-	-	-	-	25	-	-	-	-	-	-	-	-	-	-	-	-	-	-	-	-	25	25
	Utility Solar - PV - East	-	-	-	-	-	154	-	-	-	-	-	-	-	-	-	-	-	-	-	-	-	-	154	154
	DSM, Class 1, UT-DLC-RES	-	-	-	-	-	-	-	-	-	-	-	-	-	-	-	-	-	-	4.9	-	-	-	4.9	
	DSM, Class 1 Total	-	-	-	-	-	-	-	-	-	-	-	-	-	-	-	-	-	-	4.9	-	-	-	4.9	
	DSM, Class 2, ID	4	4	5	5	5	4	4	4	5	5	4	4	4	5	5	4	4	4	4	4	4	4	44	86
	DSM, Class 2, UT	69	78	84	86	92	81	84	90	91	92	74	73	72	73	71	66	65	65	63	64	64	64	845	1,531
	DSM, Class 2, WY	7	8	10	12	14	12	13	14	15	16	13	13	13	14	14	14	14	15	15	15	15	121	261	
	DSM, Class 2 Total	79	90	99	102	111	97	101	108	110	112	91	89	90	92	90	84	84	84	82	83	83	1,010	1,878	
FOT Mona Q3	-	-	-	-	15	-	-	-	142	133	114	237	53	44	82	122	130	138	240	75	114	40	82		
West	Existing Plant Retirements/Conversions																								
	JimBridger 1 (Coal Early Retirement/Conversions)	-	-	-	-	-	-	-	-	-	(354)	-	-	-	-	-	-	-	-	-	-	-	(354)	(354)	
	JimBridger 2 (Coal Early Retirement/Conversions)	-	-	-	-	-	-	-	-	-	-	-	-	-	-	-	-	-	-	(359)	-	-	-	(359)	
	Expansion Resources																								
	Wind, YK, 29	-	-	-	-	-	-	-	-	-	27	-	-	-	-	-	-	-	-	-	-	-	-	27	27
	Total Wind	-	-	-	-	-	-	-	-	-	27	-	-	-	-	-	-	-	-	-	-	-	-	27	27
	Oregon Solar Capacity Standard	-	7	-	-	-	-	-	-	-	-	-	-	-	-	-	-	-	-	-	-	-	-	7	7
	DSM, Class 1, OR-Curtail	-	-	-	-	-	-	-	-	-	-	10.6	-	10.6	-	-	10.6	-	-	-	1.1	-	-	10.6	32.9
	DSM, Class 1, OR-Irrigate	-	-	-	-	-	-	-	-	5.0	3.4	-	-	-	-	-	-	-	-	-	-	-	-	8.4	8.4
	DSM, Class 1 Total	-	-	-	-	-	-	-	-	5.0	3.4	10.6	-	10.6	-	-	10.6	-	-	-	1.1	-	-	19.0	41.3
	DSM, Class 2, CA	1	2	2	2	2	1	1	2	2	2	1	1	1	1	1	1	1	1	1	1	1	1	16	29
	DSM, Class 2, OR	44	39	36	32	29	27	25	25	23	23	21	21	21	21	20	20	20	19	19	19	19	303	504	
	DSM, Class 2, WA	8	9	10	10	11	9	10	10	11	11	9	9	9	9	8	8	8	8	7	7	7	98	178	
	DSM, Class 2 Total	54	49	47	44	42	38	36	36	36	35	31	31	30	30	30	29	29	29	27	27	27	417	710	
	FOT COB Q3	-	96	151	117	268	268	-	268	268	268	160	222	268	268	268	268	268	268	167	268	170	206		
	FOT MidColumbia Q3	400	400	400	400	400	400	400	400	400	400	400	400	400	400	400	400	400	400	400	400	400	400	400	400
	FOT MidColumbia Q3 - 2	228	375	375	375	375	375	321	375	375	375	375	375	375	375	375	375	375	375	375	375	375	355	365	
	FOT NOB Q3	100	100	100	100	100	100	100	100	100	100	100	100	100	100	100	100	100	100	100	100	100	100	100	100
	Existing Plant Retirements/Conversions	(222)	-	-	57	(106)	-	-	-	(450)	-	(354)	-	-	-	(326)	-	(694)	(77)	-	(1,316)	-	-	-	-
	Annual Additions, Long Term Resources	133	146	146	146	153	314	137	149	149	607	121	554	120	436	119	948	113	118	1,802	111	-	-	-	
	Annual Additions, Short Term Resources	728	971	1,026	992	1,158	1,143	821	1,285	1,276	1,257	1,380	1,088	1,141	1,225	1,265	1,273	1,281	1,383	1,117	1,257	-	-	-	
	Total Annual Additions	861	1,117	1,172	1,138	1,311	1,457	959	1,435	1,425	1,864	1,501	1,642	1,261	1,661	1,384	2,221	1,393	1,500	2,919	1,368	-	-	-	

1/ Front office transaction amounts reflect one-year transaction periods, are not additive, and are reported as a 10/20-year annual average.

Case S-05		Capacity (MW)																				Resource Totals 1/			
		2015	2016	2017	2018	2019	2020	2021	2022	2023	2024	2025	2026	2027	2028	2029	2030	2031	2032	2033	2034	10-year	20-year		
East	Existing Plant Retirements/Conversions																								
	Hayden 1	-	-	-	-	-	-	-	-	-	-	-	-	-	-	-	-	-	(45)	-	-	-	-	(45)	
	Hayden 2	-	-	-	-	-	-	-	-	-	-	-	-	-	-	-	-	-	(33)	-	-	-	-	(33)	
	Hunter 2 (Coal Early Retirement/Conversions)	-	-	-	-	-	-	-	-	-	-	-	-	-	-	-	-	-	-	-	(269)	-	-	(269)	
	Huntington 2 (Coal Early Retirement/Conversions)	-	-	-	-	-	-	-	-	(450)	-	-	-	-	-	-	-	-	-	-	-	-	-	(450)	(450)
	Carbon 1 (Coal Early Retirement/Conversions)	(67)	-	-	-	-	-	-	-	-	-	-	-	-	-	-	-	-	-	-	-	-	-	(67)	(67)
	Carbon 2 (Coal Early Retirement/Conversions)	(105)	-	-	-	-	-	-	-	-	-	-	-	-	-	-	-	-	-	-	-	-	-	(105)	(105)
	Cholla 4 (Coal Early Retirement/Conversions)	-	-	-	-	-	-	-	-	-	-	-	(387)	-	-	-	-	-	-	-	-	-	-	-	(387)
	DaveJohnston 1 (Coal Early Retirement/Conversions)	-	-	-	-	(106)	-	-	-	-	-	-	-	-	-	-	-	-	-	-	-	-	-	(106)	(106)
	DaveJohnston 2	-	-	-	-	-	-	-	-	-	-	-	-	-	(106)	-	-	-	-	-	-	-	-	-	(106)
	DaveJohnston 3	-	-	-	-	-	-	-	-	-	-	-	-	-	(220)	-	-	-	-	-	-	-	-	-	(220)
	DaveJohnston 4	-	-	-	-	-	-	-	-	-	-	-	-	-	-	-	-	-	-	(330)	-	-	-	-	(330)
	Naughton 1	-	-	-	-	-	-	-	-	-	-	-	-	-	-	-	-	(156)	-	-	-	-	-	-	(156)
	Naughton 2	-	-	-	-	-	-	-	-	-	-	-	-	-	-	-	(201)	-	-	-	-	-	-	-	(201)
	Naughton 3 (Coal Early Retirement/Conversions)	(50)	-	-	(280)	-	-	-	-	-	-	-	-	-	-	-	-	-	-	-	-	-	-	(330)	(330)
	Gadsby 1-6	-	-	-	-	-	-	-	-	-	-	-	-	-	-	-	-	-	-	(358)	-	-	-	-	(358)
	Coal Ret_AZ - Gas RePower	-	-	-	-	-	-	-	-	-	-	387	-	-	-	-	-	-	-	-	-	-	-	-	387
	Coal Ret_WY - Gas RePower	-	-	-	337	-	-	-	-	-	-	-	-	-	-	-	-	(337)	-	-	-	-	-	-	337
	Expansion Resources																								
	CCCT - DJohns - F 1x1	-	-	-	-	-	-	-	-	-	-	-	-	-	-	313	-	-	-	-	-	-	-	-	313
	CCCT - DJohns - J 1x1	-	-	-	-	-	-	-	-	-	-	-	-	-	-	-	-	-	-	-	423	-	-	-	423
	CCCT - Huntington - J 1x1	-	-	-	-	-	-	-	-	-	-	-	-	423	-	-	-	-	-	-	-	-	-	-	423
	CCCT - Naughton - J 1x1	-	-	-	-	-	-	-	-	-	-	-	-	-	-	-	-	-	-	-	401	-	-	-	401
	CCCT - Utah-N - F 2x1	-	-	-	-	-	-	-	-	-	-	-	-	-	-	-	-	-	-	-	-	635	-	-	635
	CCCT - Utah-S - J 1x1	-	-	-	-	-	-	-	-	-	-	-	-	-	-	-	-	423	-	423	-	-	-	-	846
	Total CCCT	-	-	-	-	-	-	-	-	-	-	-	-	-	423	313	-	423	-	423	824	635	-	-	3,041
	Wind, DJohnston, 43	-	-	-	-	-	25	-	-	-	-	-	-	-	-	-	-	-	-	-	-	-	-	25	25
	Total Wind	-	-	-	-	-	25	-	-	-	-	-	-	-	-	-	-	-	-	-	-	-	-	25	25
	Utility Solar - PV - East	-	-	-	-	-	154	-	-	-	-	-	-	-	-	-	-	-	-	-	-	-	-	154	154
	DSM, Class 2, ID	4	4	5	5	5	4	4	4	5	5	4	4	5	5	5	4	4	4	4	4	4	4	4	87
	DSM, Class 2, UT	69	78	84	86	92	81	84	88	89	90	73	73	74	73	71	68	71	71	69	64	840	1,546	840	1,546
	DSM, Class 2, WY	6	8	10	12	14	12	13	14	15	16	13	13	13	14	14	14	14	16	16	15	121	263	121	263
	DSM, Class 2 Total	79	90	99	102	111	97	101	106	108	111	90	90	92	92	90	86	90	91	89	83	1,005	1,896	1,005	1,896
FOT Mona Q3	-	-	-	-	-	-	-	-	53	145	189	208	44	196	44	122	92	75	300	229	20	85	20	85	
West	Existing Plant Retirements/Conversions																								
	JimBridger 1 (Coal Early Retirement/Conversions)	-	-	-	-	-	-	-	-	-	(354)	-	-	-	-	-	-	-	-	-	-	-	-	(354)	(354)
	JimBridger 2 (Coal Early Retirement/Conversions)	-	-	-	-	-	-	-	-	-	-	-	-	-	-	-	-	-	-	(359)	-	-	-	-	(359)
	Expansion Resources																								
	Wind, YK, 29	-	-	-	-	-	-	-	-	-	27	-	-	-	-	-	-	-	-	-	-	-	-	27	27
	Total Wind	-	-	-	-	-	-	-	-	-	27	-	-	-	-	-	-	-	-	-	-	-	-	27	27
	Oregon Solar Capacity Standard	-	7	-	-	-	-	-	-	-	-	-	-	-	-	-	-	-	-	-	-	-	-	7	7
	DSM, Class 1, OR-Curtail	-	-	-	-	-	-	-	-	-	-	-	10.6	-	-	-	-	-	-	-	-	-	-	-	10.6
	DSM, Class 1, OR-Irrigate	-	-	-	-	-	-	-	5.0	-	3.4	-	-	-	-	-	-	-	-	-	-	-	-	8.4	8.4
	DSM, Class 1 Total	-	-	-	-	-	-	-	5.0	-	3.4	-	10.6	-	-	-	-	-	-	-	-	-	-	8.4	19.0
	DSM, Class 2, CA	1	2	2	2	2	1	1	2	2	2	1	1	1	1	1	1	1	1	1	1	1	1	16	28
	DSM, Class 2, OR	44	39	35	32	29	27	25	25	23	23	21	21	21	20	20	20	20	19	19	19	19	303	504	
	DSM, Class 2, WA	8	9	10	10	10	9	9	10	11	11	9	9	9	8	8	8	8	8	8	8	7	97	177	
	DSM, Class 2 Total	54	49	47	44	42	38	36	36	36	35	31	31	30	30	29	29	29	28	27	416	709	416	709	
	FOT COB Q3	-	71	139	90	252	185	-	230	268	268	268	268	239	268	140	268	268	221	204	103	150	187	150	187
	FOT MidColumbia Q3	400	400	400	400	400	400	400	400	400	400	400	400	400	400	400	400	400	400	400	400	400	400	400	400
	FOT MidColumbia Q3 - 2	224	375	375	375	375	375	262	375	375	375	375	375	375	375	375	375	375	375	375	375	375	375	349	362
	FOT NOB Q3	100	100	100	100	100	100	100	100	100	100	100	100	100	100	100	100	100	100	100	100	100	100	100	100
	Existing Plant Retirements/Conversions	(222)	-	-	57	(106)	-	-	(450)	-	(354)	-	-	-	-	(326)	-	(694)	(77)	-	(1,316)	-	-	-	-
	Annual Additions, Long Term Resources	133	146	146	146	153	314	137	147	144	176	120	131	545	436	119	538	119	542	940	745	-	-	-	-
	Annual Additions, Short Term Resources	724	946	1,014	965	1,127	1,060	762	1,105	1,196	1,288	1,332	1,351	1,158	1,339	1,059	1,265	1,235	1,171	1,379	1,207	-	-	-	-
	Total Annual Additions	857	1,092	1,160	1,111	1,280	1,373	899	1,252	1,340	1,464	1,452	1,482	1,704	1,775	1,179	1,803	1,353	1,713	2,319	1,952	-	-	-	-

1/ Front office transaction amounts reflect one-year transaction periods, are not additive, and are reported as a 10/20-year annual average.

Case S-06		Capacity (MW)																				Resource Totals 1/			
		2015	2016	2017	2018	2019	2020	2021	2022	2023	2024	2025	2026	2027	2028	2029	2030	2031	2032	2033	2034	10-year	20-year		
East	Existing Plant Retirements/Conversions																								
	Hayden 1	-	-	-	-	-	-	-	-	-	-	-	-	-	-	-	-	-	(45)	-	-	-	-	(45)	
	Hayden 2	-	-	-	-	-	-	-	-	-	-	-	-	-	-	-	-	-	(33)	-	-	-	-	(33)	
	Hunter 2 (Coal Early Retirement/Conversions)	-	-	-	-	-	-	-	-	-	-	-	-	-	-	-	-	-	-	-	(269)	-	-	(269)	
	Huntington 2 (Coal Early Retirement/Conversions)	-	-	-	-	-	-	-	-	(450)	-	-	-	-	-	-	-	-	-	-	-	-	-	(450)	
	Carbon 1 (Coal Early Retirement/Conversions)	(67)	-	-	-	-	-	-	-	-	-	-	-	-	-	-	-	-	-	-	-	-	-	(67)	
	Carbon 2 (Coal Early Retirement/Conversions)	(105)	-	-	-	-	-	-	-	-	-	-	-	-	-	-	-	-	-	-	-	-	-	(105)	
	Cholla 4 (Coal Early Retirement/Conversions)	-	-	-	-	-	-	-	-	-	-	-	(387)	-	-	-	-	-	-	-	-	-	-	(387)	
	DaveJohnston 1 (Coal Early Retirement/Conversions)	-	-	-	-	(106)	-	-	-	-	-	-	-	-	-	-	-	-	-	-	-	-	-	(106)	
	DaveJohnston 2	-	-	-	-	-	-	-	-	-	-	-	-	-	(106)	-	-	-	-	-	-	-	-	(106)	
	DaveJohnston 3	-	-	-	-	-	-	-	-	-	-	-	-	-	(220)	-	-	-	-	-	-	-	-	(220)	
	DaveJohnston 4	-	-	-	-	-	-	-	-	-	-	-	-	-	-	-	-	-	-	-	(330)	-	-	(330)	
	Naughton 1	-	-	-	-	-	-	-	-	-	-	-	-	-	-	-	(156)	-	-	-	-	-	-	(156)	
	Naughton 2	-	-	-	-	-	-	-	-	-	-	-	-	-	-	-	(201)	-	-	-	-	-	-	(201)	
	Naughton 3 (Coal Early Retirement/Conversions)	(50)	-	-	(280)	-	-	-	-	-	-	-	-	-	-	-	-	-	-	-	-	-	-	(330)	
	Gadsby 1-6	-	-	-	-	-	-	-	-	-	-	-	-	-	-	-	-	-	-	(358)	-	-	-	(358)	
	Coal Ret_AZ - Gas RePower	-	-	-	-	-	-	-	-	-	-	387	-	-	-	-	-	-	-	-	-	-	-	387	
	Coal Ret_WY - Gas RePower	-	-	-	337	-	-	-	-	-	-	-	-	-	-	-	-	(337)	-	-	-	-	-	337	
	Expansion Resources																								
	CCCT - DJohns - F 1xl	-	-	-	-	-	-	-	-	-	-	-	-	-	-	313	-	-	-	-	-	-	-	313	
	CCCT - DJohns - J 1xl	-	-	-	-	-	-	-	-	-	-	-	-	-	-	-	-	-	-	-	423	-	-	423	
	CCCT - Huntington - J 1xl	-	-	-	-	-	-	-	-	-	-	-	-	-	-	-	-	423	-	-	-	-	-	423	
	CCCT - Naughton - J 1xl	-	-	-	-	-	-	-	-	-	-	-	-	-	-	-	-	-	-	-	401	-	-	401	
	CCCT - Utah-N - F 2xl	-	-	-	-	-	-	-	-	-	-	-	-	-	-	-	-	-	-	-	635	-	-	635	
	CCCT - Utah-S - J 1xl	-	-	-	-	-	-	-	-	-	-	-	-	-	-	423	-	-	-	-	423	-	-	846	
	Total CCCT	-	-	-	-	-	-	-	-	-	-	-	-	-	-	736	-	423	-	-	1,882	-	-	3,041	
	Wind_DJohnston_43	-	-	-	-	-	25	-	-	-	-	-	-	-	-	-	-	-	-	-	-	-	-	25	
	Total Wind	-	-	-	-	-	25	-	-	-	-	-	-	-	-	-	-	-	-	-	-	-	-	25	
	Utility Solar - PV - East	-	-	-	-	-	12	-	-	-	-	-	-	-	-	-	-	-	-	142	-	-	12	154	
	DSM, Class 2, ID	4	4	5	5	5	4	4	4	5	6	5	5	5	5	5	4	4	4	4	4	4	4	92	
	DSM, Class 2, UT	69	78	84	86	92	81	86	92	94	93	78	81	80	80	79	73	73	71	71	70	854	1,609		
	DSM, Class 2, WY	7	8	10	12	14	12	13	14	15	16	13	13	14	15	15	15	16	16	17	16	122	272		
	DSM, Class 2 Total	79	90	99	102	111	97	103	111	114	115	96	99	99	99	98	92	93	92	92	90	1,022	1,973		
	FOT Mona Q3	-	-	-	-	-	9	43	-	171	101	21	100	130	196	44	44	156	139	300	34	209	34	85	
	West	Existing Plant Retirements/Conversions																							
		JimBridger 1 (Coal Early Retirement/Conversions)	-	-	-	-	-	-	-	-	(354)	-	-	-	-	-	-	-	-	-	-	-	(354)	(354)	
		JimBridger 2 (Coal Early Retirement/Conversions)	-	-	-	-	-	-	-	-	-	-	-	-	-	-	-	-	-	-	(359)	-	-	(359)	
		Expansion Resources																							
		Wind, YK, 29	-	-	-	-	-	-	-	-	209	-	-	-	-	-	-	-	-	-	-	-	-	209	209
		Total Wind	-	-	-	-	-	-	-	-	209	-	-	-	-	-	-	-	-	-	-	-	-	-	209
Oregon Solar Capacity Standard		-	7	-	-	-	-	-	-	-	-	-	-	-	-	-	-	-	-	-	-	-	7	7	
DSM, Class 1, OR-Curtail		-	-	-	-	-	-	-	-	10.6	-	-	10.6	-	-	-	-	10.6	-	-	-	-	10.6	31.8	
DSM, Class 1, OR-Irrigate		-	-	-	-	-	-	-	5.0	-	-	3.4	-	-	-	-	-	-	-	-	-	-	5.0	8.4	
DSM, Class 1 Total		-	-	-	-	-	-	-	5.0	10.6	-	3.4	10.6	-	-	-	-	10.6	-	-	-	-	15.6	40.2	
DSM, Class 2, CA		1	2	2	2	2	1	1	2	2	2	1	1	1	1	1	1	1	1	1	1	1	16	29	
DSM, Class 2, OR		44	39	36	32	29	27	25	25	24	21	22	22	22	21	21	21	21	19	19	305	514			
DSM, Class 2, WA		8	9	10	10	11	9	10	10	11	11	9	9	9	9	8	8	8	8	8	7	98	181		
DSM, Class 2 Total		54	49	47	44	42	38	36	36	37	36	31	32	32	32	30	30	30	28	27	420	724			
Pump Storage - West		-	-	-	-	-	-	-	-	-	400	-	-	-	-	-	-	-	-	-	-	-	400	400	
FOT COB Q3		-	92	148	112	268	268	-	268	268	268	268	268	268	197	68	268	268	218	-	137	169	183		
FOT MidColumbia Q3		400	400	400	400	400	400	400	400	400	400	400	400	400	400	400	400	400	400	400	400	400	400	400	
FOT MidColumbia Q3 - 2		226	375	375	375	375	375	363	375	375	375	375	375	375	375	375	375	375	375	375	375	375	359	367	
FOT NOB Q3		100	100	100	100	100	100	100	100	100	100	100	100	100	100	100	100	100	100	100	100	100	100	100	
Existing Plant Retirements/Conversions		(222)	-	-	57	(106)	-	-	(450)	-	(354)	-	-	-	(326)	-	(694)	(77)	-	(1,316)	-	-	-	-	
Annual Additions, Long Term Resources		133	147	146	147	153	172	139	151	370	551	130	142	131	868	130	546	133	264	2,002	118	-	-		
Annual Additions, Short Term Resources		726	967	1,023	987	1,152	1,186	863	1,314	1,244	1,164	1,243	1,273	1,339	1,116	987	1,299	1,282	1,393	909	1,221	-	-		
Total Annual Additions		860	1,114	1,169	1,134	1,305	1,358	1,002	1,465	1,614	1,715	1,373	1,415	1,470	1,984	1,117	1,845	1,415	1,657	2,910	1,339	-	-		

1/ Front office transaction amounts reflect one-year transaction periods, are not additive, and are reported as a 10/20-year annual average.

Case S-07		Capacity (MW)																				Resource Totals 1/		
		2015	2016	2017	2018	2019	2020	2021	2022	2023	2024	2025	2026	2027	2028	2029	2030	2031	2032	2033	2034	10-year	20-year	
East	Existing Plant Retirements/Conversions																							
	Hayden 1	-	-	-	-	-	-	-	-	-	-	-	-	-	-	-	-	-	(45)	-	-	-	-	(45)
	Hayden 2	-	-	-	-	-	-	-	-	-	-	-	-	-	-	-	-	-	(33)	-	-	-	-	(33)
	Hunter 2 (Coal Early Retirement/Conversions)	-	-	-	-	-	-	-	-	-	-	-	-	-	-	-	-	-	-	-	(269)	-	-	(269)
	Huntington 2 (Coal Early Retirement/Conversions)	-	-	-	-	-	-	-	(450)	-	-	-	-	-	-	-	-	-	-	-	-	-	-	(450)
	Carbon 1 (Coal Early Retirement/Conversions)	(67)	-	-	-	-	-	-	-	-	-	-	-	-	-	-	-	-	-	-	-	-	-	(67)
	Carbon 2 (Coal Early Retirement/Conversions)	(105)	-	-	-	-	-	-	-	-	-	-	-	-	-	-	-	-	-	-	-	-	-	(105)
	Cholla 4 (Coal Early Retirement/Conversions)	-	-	-	-	-	-	-	-	-	-	(387)	-	-	-	-	-	-	-	-	-	-	-	(387)
	DaveJohnston 1 (Coal Early Retirement/Conversions)	-	-	-	-	(106)	-	-	-	-	-	-	-	-	-	-	-	-	-	-	-	-	-	(106)
	DaveJohnston 2	-	-	-	-	-	-	-	-	-	-	-	-	-	-	(106)	-	-	-	-	-	-	-	(106)
	DaveJohnston 3	-	-	-	-	-	-	-	-	-	-	-	-	-	-	(220)	-	-	-	-	-	-	-	(220)
	DaveJohnston 4	-	-	-	-	-	-	-	-	-	-	-	-	-	-	-	-	-	-	-	(330)	-	-	(330)
	Naughton 1	-	-	-	-	-	-	-	-	-	-	-	-	-	-	-	-	(156)	-	-	-	-	-	(156)
	Naughton 2	-	-	-	-	-	-	-	-	-	-	-	-	-	-	-	-	(201)	-	-	-	-	-	(201)
	Naughton 3 (Coal Early Retirement/Conversions)	(50)	-	-	(280)	-	-	-	-	-	-	-	-	-	-	-	-	-	-	-	-	-	-	(330)
	Gadsby 1-6	-	-	-	-	-	-	-	-	-	-	-	-	-	-	-	-	-	-	(358)	-	-	-	(358)
	Coal Ret_AZ - Gas RePower	-	-	-	-	-	-	-	-	-	-	387	-	-	-	-	-	-	-	-	-	-	-	387
	Coal Ret_WY - Gas RePower	-	-	-	337	-	-	-	-	-	-	-	-	-	-	-	-	(337)	-	-	-	-	-	337
	Expansion Resources																							
	CCCT - DJohns - F 1x1	-	-	-	-	-	-	-	-	-	-	-	-	-	-	313	-	-	-	-	-	-	-	313
	CCCT - DJohns - J 1x1	-	-	-	-	-	-	-	-	-	-	-	-	-	-	-	-	-	-	-	423	-	-	423
	CCCT - Huntington - J 1x1	-	-	-	-	-	-	-	-	-	-	-	-	-	-	-	-	423	-	-	-	-	-	423
	CCCT - Naughton - J 1x1	-	-	-	-	-	-	-	-	-	-	-	-	-	-	-	-	-	-	-	-	401	-	401
	CCCT - Utah-S - J 1x1	-	-	-	-	-	-	-	-	-	-	-	-	-	-	-	846	-	-	-	-	-	-	846
	Total CCCT	-	-	-	-	-	-	-	-	-	-	-	-	-	-	313	-	1,269	-	-	423	401	-	2,406
	Wind, DJohnston, 43	-	-	-	-	-	-	-	25	-	-	-	-	-	-	-	-	-	-	-	-	-	25	25
	Wind, WYAE, 43	-	-	-	-	-	-	-	500	-	-	-	-	-	-	-	-	-	-	-	-	-	-	500
	Total Wind	-	-	-	-	-	-	-	525	-	-	-	-	-	-	-	-	-	-	-	-	-	-	525
	Utility Solar - PV - East	-	-	-	-	-	-	108	-	-	-	-	-	-	-	-	-	-	23	-	-	-	-	108
DSM, Class 2, ID	4	4	10	10	10	9	9	9	9	9	7	7	7	7	7	6	6	6	6	6	6	6	81	
DSM, Class 2, UT	69	78	112	110	122	108	112	116	124	123	99	119	119	121	118	104	103	101	101	100	1,073	2,157		
DSM, Class 2, WY	6	8	18	20	23	21	22	23	24	25	19	20	20	21	20	20	20	21	21	21	189	392		
DSM, Class 2 Total	79	90	139	139	154	138	143	148	157	157	126	146	146	149	145	130	130	128	128	127	1,343	2,697		
FOT Mona Q3	-	-	-	-	-	-	-	-	-	-	44	44	50	149	44	-	-	-	-	266	75	-	34	
West	Existing Plant Retirements/Conversions																							
	JimBridger 1 (Coal Early Retirement/Conversions)	-	-	-	-	-	-	-	-	-	(354)	-	-	-	-	-	-	-	-	-	-	-	(354)	
	JimBridger 2 (Coal Early Retirement/Conversions)	-	-	-	-	-	-	-	-	-	-	-	-	-	-	-	-	-	-	-	(359)	-	(359)	
	Expansion Resources																							
	CCCT - Jbridge - J 1x1	-	-	-	-	-	-	-	-	-	-	-	-	-	-	-	-	-	-	-	401	-	401	
	Total CCCT	-	-	-	-	-	-	-	-	-	-	-	-	-	-	-	-	-	-	-	401	-	401	
	Oregon Solar Capacity Standard	-	7	-	-	-	-	-	-	-	-	-	-	-	-	-	-	-	-	-	-	-	7	
	DSM, Class 1, OR-Curtail	-	-	-	-	-	-	-	-	-	10.6	-	10.6	-	-	-	10.6	-	-	-	-	-	10.6	
	DSM, Class 1, OR-Irrigate	-	-	-	-	-	-	3.4	5.0	-	-	-	-	-	-	-	-	-	-	-	-	-	8.4	
	DSM, Class 1 Total	-	-	-	-	-	-	3.4	5.0	-	10.6	-	10.6	-	-	-	10.6	-	-	-	-	-	19.0	
	DSM, Class 2, CA	1	2	3	3	4	3	3	3	3	3	2	3	3	3	2	2	2	2	2	2	2	28	
	DSM, Class 2, OR	44	39	61	55	51	48	45	43	41	39	37	36	37	34	32	32	33	30	30	464	801		
	DSM, Class 2, WA	8	9	19	19	19	17	17	17	18	18	14	14	14	14	13	11	11	11	10	10	163	282	
	DSM, Class 2 Total	54	49	83	77	73	68	65	64	62	60	53	53	52	53	50	45	45	45	41	42	655	1,134	
	FOT COB Q3	-	93	102	25	143	142	-	72	18	262	268	253	268	268	200	-	-	-	20	139	86	114	
	FOT MidColumbia Q3	400	400	400	400	400	400	400	400	400	400	400	400	400	400	400	400	400	400	400	400	400	400	
	FOT MidColumbia Q3 - 2	227	375	375	375	375	375	192	375	375	375	375	375	375	375	375	170	149	223	375	375	342	329	
	FOT NOB Q3	100	100	100	100	100	100	100	100	100	100	100	100	100	100	100	100	100	100	100	100	100	100	
	Existing Plant Retirements/Conversions	(222)	-	-	57	(106)	-	-	(450)	-	(354)	-	-	-	-	(326)	-	(694)	(77)	-	(1,316)	-	-	
	Annual Additions, Long Term Resources	132	146	223	216	227	205	318	742	219	228	179	209	198	515	195	1,455	198	173	993	569	-	-	
	Annual Additions, Short Term Resources	727	968	977	900	1,018	1,017	692	947	893	1,137	1,187	1,172	1,193	1,292	1,119	670	649	723	1,161	1,089	-	-	
	Total Annual Additions	859	1,115	1,200	1,117	1,246	1,222	1,010	1,689	1,112	1,365	1,366	1,381	1,391	1,807	1,314	2,125	847	896	2,154	1,658	-	-	

1/ Front office transaction amounts reflect one-year transaction periods, are not additive, and are reported as a 10-20 year annual average.

Case S-08		Capacity (MW)																				Resource Totals 1/				
		2015	2016	2017	2018	2019	2020	2021	2022	2023	2024	2025	2026	2027	2028	2029	2030	2031	2032	2033	2034	10-year	20-year			
East	Existing Plant Retirements/Conversions																									
	Hayden 1	-	-	-	-	-	-	-	-	-	-	-	-	-	-	-	-	-	(45)	-	-	-	-	(45)		
	Hayden 2	-	-	-	-	-	-	-	-	-	-	-	-	-	-	-	-	-	(33)	-	-	-	-	(33)		
	Hunter 2 (Coal Early Retirement/Conversions)	-	-	-	-	-	-	-	-	-	-	-	-	-	-	-	-	-	-	-	(269)	-	-	(269)		
	Huntington 2 (Coal Early Retirement/Conversions)	-	-	-	-	-	-	-	(450)	-	-	-	-	-	-	-	-	-	-	-	-	-	-	(450)	(450)	
	Carbon 1 (Coal Early Retirement/Conversions)	(67)	-	-	-	-	-	-	-	-	-	-	-	-	-	-	-	-	-	-	-	-	-	(67)	(67)	
	Carbon 2 (Coal Early Retirement/Conversions)	(105)	-	-	-	-	-	-	-	-	-	-	-	-	-	-	-	-	-	-	-	-	-	(105)	(105)	
	Cholla 4 (Coal Early Retirement/Conversions)	-	-	-	-	-	-	-	-	-	-	(387)	-	-	-	-	-	-	-	-	-	-	-	-	(387)	
	DaveJohnston 1 (Coal Early Retirement/Conversions)	-	-	-	-	(106)	-	-	-	-	-	-	-	-	-	-	-	-	-	-	-	-	-	(106)	(106)	
	DaveJohnston 2	-	-	-	-	-	-	-	-	-	-	-	-	-	-	(106)	-	-	-	-	-	-	-	-	(106)	
	DaveJohnston 3	-	-	-	-	-	-	-	-	-	-	-	-	-	-	(220)	-	-	-	-	-	-	-	-	(220)	
	DaveJohnston 4	-	-	-	-	-	-	-	-	-	-	-	-	-	-	-	-	-	-	-	(330)	-	-	-	(330)	
	Naughton 1	-	-	-	-	-	-	-	-	-	-	-	-	-	-	-	-	(156)	-	-	-	-	-	-	(156)	
	Naughton 2	-	-	-	-	-	-	-	-	-	-	-	-	-	-	-	-	(201)	-	-	-	-	-	-	(201)	
	Naughton 3 (Coal Early Retirement/Conversions)	(50)	-	-	(280)	-	-	-	-	-	-	-	-	-	-	-	-	-	-	-	-	-	-	(330)	(330)	
	Gadsby 1-6	-	-	-	-	-	-	-	-	-	-	-	-	-	-	-	-	-	-	(358)	-	-	-	-	(358)	
	Coal Ret_AZ - Gas RePower	-	-	-	-	-	-	-	-	-	-	387	-	-	-	-	-	-	-	-	-	-	-	-	387	
	Coal Ret_WY - Gas RePower	-	-	-	337	-	-	-	-	-	-	-	-	-	-	-	-	(337)	-	-	-	-	-	-	337	
	Expansion Resources																									
	CCCT - DJohns - F 1xl	-	-	-	-	-	-	-	-	-	-	-	-	-	-	-	-	-	-	-	313	-	-	-	313	
	CCCT - DJohns - J 1xl	-	-	-	-	-	-	-	-	-	-	-	-	-	-	-	-	-	-	-	423	-	-	-	423	
	CCCT - Huntington - J 1xl	-	-	-	-	-	-	-	-	-	-	-	-	-	-	-	-	423	-	-	-	-	-	-	423	
	CCCT - Utah-N - F 2xl	-	-	-	-	-	-	-	-	-	-	-	-	-	-	-	-	-	-	-	-	-	635	-	635	
	CCCT - Utah-S - J 1xl	-	-	-	-	-	-	-	-	-	-	-	-	-	-	423	-	-	-	423	-	-	-	-	846	
	Total CCCT	-	-	-	-	-	-	-	-	-	-	-	-	-	-	423	-	423	423	-	736	635	-	-	2,640	
	Wind, WYAE, 43	-	-	-	-	-	-	-	383	365	-	-	-	-	-	-	-	211	-	-	-	-	-	748	959	
	Total Wind	-	-	-	-	-	-	-	383	365	-	-	-	-	-	-	-	211	-	-	-	-	-	-	748	959
	DSM, Class 1, UT-DLC-RES	-	-	-	-	-	-	-	-	-	-	-	-	-	-	-	-	-	-	-	4.9	-	-	-	4.9	
	DSM, Class 1 Total	-	-	-	-	-	-	-	-	-	-	-	-	-	-	-	-	-	-	-	4.9	-	-	-	4.9	
	DSM, Class 2, ID	4	4	10	10	10	9	9	9	9	9	7	7	7	7	7	6	6	6	6	6	6	6	81	148	
	DSM, Class 2, UT	69	78	112	108	122	108	112	119	124	123	99	119	119	121	118	104	103	101	101	100	100	1,074	2,158		
	DSM, Class 2, WY	6	8	18	20	22	21	22	23	24	25	19	20	20	21	21	20	20	21	21	21	21	189	392		
	DSM, Class 2 Total	79	90	139	138	154	138	143	150	156	157	126	146	146	149	145	130	130	128	128	127	1,344	2,698			
	FOT Mona Q3	-	-	-	-	-	-	-	-	-	3	44	44	48	57	44	131	-	-	75	75	-	-	0	26	
	Existing Plant Retirements/Conversions																									
	JimBridger 1 (Coal Early Retirement/Conversions)	-	-	-	-	-	-	-	-	-	(354)	-	-	-	-	-	-	-	-	-	-	-	-	(354)	(354)	
	JimBridger 2 (Coal Early Retirement/Conversions)	-	-	-	-	-	-	-	-	-	-	-	-	-	-	-	-	-	-	-	(359)	-	-	-	(359)	
	Expansion Resources																									
	CCCT - Jbridger - J 1xl	-	-	-	-	-	-	-	-	-	-	-	-	-	-	-	-	-	-	-	401	-	-	-	401	
	Total CCCT	-	-	-	-	-	-	-	-	-	-	-	-	-	-	-	-	-	-	-	401	-	-	-	401	
	Oregon Solar Capacity Standard	-	7	-	-	-	-	-	-	-	-	-	-	-	-	-	-	-	-	-	-	-	-	7	7	
	DSM, Class 1, OR-Curtail	-	-	-	-	-	-	-	-	-	10.6	10.6	10.6	-	-	-	-	-	-	-	-	-	-	10.6	31.8	
	DSM, Class 1, OR-DLC-RES	-	-	-	-	-	-	-	-	-	-	-	-	-	-	-	-	-	4.5	-	-	-	-	-	4.5	
	DSM, Class 1, OR-Irrigate	-	-	-	-	-	-	-	8.4	-	-	-	-	-	-	-	-	-	-	-	-	-	-	8.4	8.4	
	DSM, Class 1 Total	-	-	-	-	-	-	-	8.4	-	10.6	10.6	10.6	-	-	-	-	-	4.5	-	-	-	-	19.0	44.7	
DSM, Class 2, CA	1	2	3	3	4	3	3	3	3	3	3	2	3	3	3	2	2	2	2	2	2	2	28	51		
DSM, Class 2, OR	44	39	58	57	51	48	45	44	41	39	37	36	36	37	34	32	32	33	30	30	30	464	801			
DSM, Class 2, WA	8	9	20	19	19	17	17	18	18	18	14	14	14	14	13	11	11	11	10	10	10	163	282			
DSM, Class 2 Total	54	49	81	79	73	68	65	64	62	60	53	53	52	53	50	45	45	45	41	42	42	655	1,134			
FOT COB Q3	-	93	103	26	144	143	-	130	26	268	266	250	268	268	108	268	-	36	189	-	93	129	129			
FOT MidColumbia Q3	400	400	400	400	400	400	400	400	400	400	400	400	400	400	400	400	400	400	400	400	400	400	400	400		
FOT MidColumbia Q3 - 2	227	375	375	375	375	375	195	375	375	375	375	375	375	375	375	375	358	375	375	331	342	356	356			
FOT NOB Q3	100	100	100	100	100	100	100	100	100	100	100	100	100	100	100	100	100	100	100	100	100	100	100			
Existing Plant Retirements/Conversions	(222)	-	-	57	(106)	-	-	(450)	-	(354)	-	-	-	-	(326)	-	(694)	(77)	-	(1,316)	-	-	-			
Annual Additions, Long Term Resources	132	146	221	217	227	205	207	606	583	228	189	209	198	624	195	809	602	174	1,311	803	-	-	-			
Annual Additions, Short Term Resources	727	968	978	901	1,019	1,018	695	1,005	901	1,146	1,185	1,169	1,190	1,200	1,027	1,274	858	986	1,139	831	-	-	-			
Total Annual Additions	859	1,115	1,199	1,118	1,247	1,223	902	1,610	1,485	1,374	1,374	1,379	1,389	1,825	1,222	2,084	1,460	1,159	2,450	1,635	-	-	-			

1/ Front office transaction amounts reflect one-year transaction periods, are not additive, and are reported as a 10/20-year annual average.

Case S-09	Capacity (MW)																				Resource Totals 1/		
	2015	2016	2017	2018	2019	2020	2021	2022	2023	2024	2025	2026	2027	2028	2029	2030	2031	2032	2033	2034	10-year	20-year	
East																							
Existing Plant Retirements/Conversions																							
Hayden 1	-	-	-	-	-	-	-	-	-	-	-	-	-	-	-	-	-	-	-	(45)	-	-	(45)
Hayden 2	-	-	-	-	-	-	-	-	-	-	-	-	-	-	-	-	-	-	-	(33)	-	-	(33)
Hunter 2 (Coal Early Retirement/Conversions)	-	-	-	-	-	-	-	-	-	-	-	-	-	-	-	-	-	-	-	-	(269)	-	(269)
Huntington 2 (Coal Early Retirement/Conversions)	-	-	-	-	-	-	-	-	(450)	-	-	-	-	-	-	-	-	-	-	-	-	-	(450)
Carbon 1 (Coal Early Retirement/Conversions)	(67)	-	-	-	-	-	-	-	-	-	-	-	-	-	-	-	-	-	-	-	-	-	(67)
Carbon 2 (Coal Early Retirement/Conversions)	(105)	-	-	-	-	-	-	-	-	-	-	-	-	-	-	-	-	-	-	-	-	-	(105)
Cholla 4 (Coal Early Retirement/Conversions)	-	-	-	-	-	-	-	-	-	-	-	-	(387)	-	-	-	-	-	-	-	-	-	(387)
DaveJohnston 1 (Coal Early Retirement/Conversions)	-	-	-	-	(106)	-	-	-	-	-	-	-	-	-	-	-	-	-	-	-	-	-	(106)
DaveJohnston 2	-	-	-	-	-	-	-	-	-	-	-	-	-	-	(106)	-	-	-	-	-	-	-	(106)
DaveJohnston 3	-	-	-	-	-	-	-	-	-	-	-	-	-	-	(220)	-	-	-	-	-	-	-	(220)
DaveJohnston 4	-	-	-	-	-	-	-	-	-	-	-	-	-	-	-	-	-	-	-	(330)	-	-	(330)
Naughton 1	-	-	-	-	-	-	-	-	-	-	-	-	-	-	-	-	(156)	-	-	-	-	-	(156)
Naughton 2	-	-	-	-	-	-	-	-	-	-	-	-	-	-	-	-	(201)	-	-	-	-	-	(201)
Naughton 3 (Coal Early Retirement/Conversions)	(50)	-	-	(280)	-	-	-	-	-	-	-	-	-	-	-	-	-	-	-	-	-	-	(330)
Gadsby 1-6	-	-	-	-	-	-	-	-	-	-	-	-	-	-	-	-	-	-	-	(358)	-	-	(358)
Coal Ret_AZ - Gas RePower	-	-	-	-	-	-	-	-	-	-	-	387	-	-	-	-	-	-	-	-	-	-	387
Coal Ret_WY - Gas RePower	-	-	-	337	-	-	-	-	-	-	-	-	-	-	-	-	(337)	-	-	-	-	-	337
Expansion Resources																							
CCCT - DJohns - F 1xl	-	-	-	-	-	-	-	-	-	-	-	-	-	-	-	-	-	-	-	313	-	-	313
CCCT - Huntington - J 1xl	-	-	-	-	-	-	-	-	-	-	-	-	-	-	-	-	423	-	-	-	-	-	423
CCCT - Naughton - J 1xl	-	-	-	-	-	-	-	-	-	-	-	-	-	-	-	401	-	-	-	-	-	-	401
CCCT - Utah-N - F 2xl	-	-	-	-	-	-	-	-	-	-	-	-	-	-	-	-	-	-	1,270	-	-	-	1,270
CCCT - Utah-S - J 1xl	-	-	-	-	-	-	-	-	-	423	-	-	-	423	-	-	-	-	-	-	-	-	423
Total CCCT	-	-	-	-	-	-	-	-	-	423	-	-	-	423	-	824	-	-	1,583	-	423	3,253	
Wind, DJohnston, 43	-	-	-	-	-	106	-	-	-	-	-	-	-	326	-	-	-	-	17	-	106	449	
Wind, UT, 31	-	-	-	-	-	-	-	143	-	-	-	-	-	-	-	-	-	-	-	-	143	143	
Total Wind	-	-	-	-	-	106	-	143	-	-	-	-	-	326	-	-	-	-	17	-	249	592	
DSM, Class 1, ID-Irrigate	-	-	-	-	-	-	-	-	-	-	-	-	-	-	-	-	-	-	-	3.5	-	3.5	
DSM, Class 1, UT-DLC-RES	-	-	-	-	-	-	-	-	-	-	-	-	-	-	-	-	-	-	-	4.9	-	4.9	
DSM, Class 1 Total	-	-	-	-	-	-	-	-	-	-	-	-	-	-	-	-	-	-	-	4.9	3.5	8.5	
DSM, Class 2, ID	4	4	5	5	5	4	4	4	5	5	4	4	5	5	5	4	4	4	4	4	4	44	87
DSM, Class 2, UT	69	78	84	86	92	81	84	88	89	90	74	73	74	74	77	72	72	73	71	71	840	1,570	
DSM, Class 2, WY	6	8	10	12	14	12	13	14	15	16	13	13	13	14	14	14	15	16	16	17	121	266	
DSM, Class 2 Total	79	90	99	102	111	97	101	106	109	111	91	90	92	92	96	90	92	93	91	92	1,005	1,923	
FOT Mona Q3	-	-	-	-	10	38	-	152	131	63	149	186	259	277	150	114	97	300	94	300	39	116	
West																							
Existing Plant Retirements/Conversions																							
JimBridger 1 (Coal Early Retirement/Conversions)	-	-	-	-	-	-	-	-	-	(354)	-	-	-	-	-	-	-	-	-	-	(354)	(354)	
JimBridger 2 (Coal Early Retirement/Conversions)	-	-	-	-	-	-	-	-	-	-	-	-	-	-	-	-	-	-	-	(359)	-	-	(359)
Expansion Resources																							
Oregon Solar Capacity Standard	-	7	-	-	-	-	-	-	-	-	-	-	-	-	-	-	-	-	-	-	7	7	
DSM, Class 1, OR-Curtail	-	-	-	-	-	-	-	-	10.6	-	-	10.6	-	-	-	-	10.6	-	-	-	10.6	31.8	
DSM, Class 1, OR-Irrigate	-	-	-	-	-	-	-	3.4	5.0	-	-	-	-	-	-	-	-	-	-	-	8.4	8.4	
DSM, Class 1 Total	-	-	-	-	-	-	-	3.4	15.6	-	-	10.6	-	-	-	-	10.6	-	-	-	19.0	40.2	
DSM, Class 2, CA	1	2	2	2	2	1	1	2	2	2	1	1	1	1	1	1	1	1	1	1	16	29	
DSM, Class 2, OR	44	39	35	33	29	27	25	25	23	23	21	21	21	22	21	20	20	20	20	19	303	507	
DSM, Class 2, WA	8	9	10	10	10	9	9	10	11	11	9	9	9	9	9	8	8	8	8	7	97	178	
DSM, Class 2 Total	54	49	47	44	42	38	36	36	36	35	31	31	31	31	31	29	29	29	28	28	416	714	
FOT COB Q3	-	93	149	113	268	268	-	268	268	268	268	268	268	268	268	268	228	166	267	169	212		
FOT MidColumbia Q3	400	400	400	400	400	400	400	400	400	400	400	400	400	400	400	400	400	400	400	400	400	400	
FOT MidColumbia Q3 - 2	227	375	375	375	375	375	359	375	375	375	375	375	375	375	375	375	375	375	375	375	359	367	
FOT NOB Q3	100	100	100	100	100	100	100	100	100	100	100	100	100	100	100	100	100	100	100	100	100	100	
Existing Plant Retirements/Conversions	(222)	-	-	57	(106)	-	-	(450)	-	(354)	-	-	-	(326)	-	(694)	(77)	-	(1,316)	-	-		
Annual Additions, Long Term Resources	133	146	146	146	152	241	137	289	160	569	121	131	123	873	127	943	131	122	1,725	123			
Annual Additions, Short Term Resources	727	968	1,024	988	1,153	1,181	859	1,295	1,274	1,206	1,292	1,329	1,402	1,420	1,293	1,257	1,240	1,403	1,135	1,442			
Total Annual Additions	860	1,114	1,170	1,135	1,305	1,422	996	1,584	1,434	1,775	1,413	1,461	1,524	2,293	1,420	2,200	1,372	1,525	2,859	1,566			

1/ Front office transaction amounts reflect one-year transaction periods, are not additive, and are reported as a 10/20-year annual average.

Case S-10_ECA		Capacity (MW)																				Resource Totals 1/	
		2015	2016	2017	2018	2019	2020	2021	2022	2023	2024	2025	2026	2027	2028	2029	2030	2031	2032	2033	2034	10-year	20-year
East	Existing Plant Retirements/Conversions																						
	Hayden 1	-	-	-	-	-	-	-	-	-	-	-	-	-	-	-	-	(45)	-	-	-	-	(45)
	Hayden 2	-	-	-	-	-	-	-	-	-	-	-	-	-	-	-	-	(33)	-	-	-	-	(33)
	Hunter 2 (Coal Early Retirement/Conversions)	-	-	-	-	-	-	-	-	-	-	-	-	-	-	-	-	-	-	(269)	-	-	(269)
	Huntington 2 (Coal Early Retirement/Conversions)	-	-	-	-	-	-	-	-	-	-	-	-	-	-	-	(450)	-	-	-	-	-	(450)
	Carbon 1 (Coal Early Retirement/Conversions)	(67)	-	-	-	-	-	-	-	-	-	-	-	-	-	-	-	-	-	-	-	(67)	(67)
	Carbon 2 (Coal Early Retirement/Conversions)	(105)	-	-	-	-	-	-	-	-	-	-	-	-	-	-	-	-	-	-	-	(105)	(105)
	Cholla 4 (Coal Early Retirement/Conversions)	-	-	-	-	-	-	-	-	-	-	(387)	-	-	-	-	-	-	-	-	-	-	(387)
	DaveJohnston 1	-	-	-	-	-	-	-	-	-	-	-	-	-	(106)	-	-	-	-	-	-	-	(106)
	DaveJohnston 2	-	-	-	-	-	-	-	-	-	-	-	-	-	(106)	-	-	-	-	-	-	-	(106)
	DaveJohnston 3	-	-	-	-	-	-	-	-	-	-	-	-	-	(220)	-	-	-	-	-	-	-	(220)
	DaveJohnston 4	-	-	-	-	-	-	-	-	-	-	-	-	-	(330)	-	-	-	-	-	-	-	(330)
	Naughton 1	-	-	-	-	-	-	-	-	-	-	-	-	-	-	-	(156)	-	-	-	-	-	(156)
	Naughton 2	-	-	-	-	-	-	-	-	-	-	-	-	-	-	-	(201)	-	-	-	-	-	(201)
	Naughton 3 (Coal Early Retirement/Conversions)	(50)	-	-	(280)	-	-	-	-	-	-	-	-	-	-	-	-	-	-	-	-	(330)	(330)
	Gadsby 1-6	-	-	-	-	-	-	-	-	-	-	-	-	-	-	-	-	-	-	(358)	-	-	(358)
	Coal Ret_AZ - Gas RePower	-	-	-	-	-	-	-	-	-	-	387	-	-	-	-	-	-	-	-	-	-	387
	Coal Ret_WY - Gas RePower	-	-	-	337	-	-	-	-	-	-	-	-	-	-	-	(337)	-	-	-	-	337	-
	Expansion Resources																						
	CCCT - DJohns - F 1xl	-	-	-	-	-	-	-	-	-	-	-	-	-	-	-	313	-	-	-	-	-	313
	CCCT - DJohns - J 1xl	-	-	-	-	-	-	-	-	-	-	-	-	-	423	-	-	-	-	-	-	-	423
	CCCT - Utah-N - F 2xl	-	-	-	-	-	-	-	-	-	-	-	-	-	-	-	-	-	-	635	-	-	635
	CCCT - Utah-N - J 1xl	-	-	-	-	-	-	-	-	-	-	-	-	-	-	-	-	-	-	423	-	-	423
	CCCT - Utah-S - J 1xl	-	-	-	-	-	-	-	-	-	-	-	-	-	-	-	846	-	-	-	-	-	846
	Total CCCT	-	-	-	-	-	-	-	-	-	-	-	-	-	423	-	1,159	-	-	1,058	-	-	2,640
	Utility Solar - PV - East	-	-	-	-	-	-	-	-	-	-	-	-	-	-	-	3	-	-	-	-	-	3
	DSM, Class 1, ID-Irrigate	-	3.5	-	-	-	-	-	-	-	-	-	-	-	-	-	16.5	-	-	-	-	3.5	20.0
	DSM, Class 1, UT-Curtail	-	-	24.0	24.5	-	-	-	-	-	-	-	-	-	-	-	-	-	-	-	-	48.5	48.5
	DSM, Class 1, UT-DLC-RES	-	5.3	6.5	6.6	-	13.3	-	-	-	-	-	-	-	-	-	-	26.1	-	-	-	31.7	57.8
DSM, Class 1, UT-Irrigate	-	6.5	-	-	-	3.5	-	-	-	-	-	-	-	-	-	6.4	-	-	-	-	10.1	16.5	
DSM, Class 1, WY-Curtail	-	-	13.0	13.2	-	-	-	-	-	-	-	-	-	-	-	-	-	-	-	-	26.2	26.2	
DSM, Class 1 Total	-	15.4	43.5	44.2	-	16.8	-	-	-	-	-	-	-	-	-	22.9	26.1	-	-	-	119.9	168.9	
DSM, Class 2, ID	8	9	6	6	7	5	4	4	5	6	5	5	5	5	5	5	5	4	4	4	60	107	
DSM, Class 2, UT	127	136	106	105	108	96	86	93	98	105	85	85	84	84	81	77	76	73	63	64	1,060	1,831	
DSM, Class 2, WY	13	15	11	13	14	13	13	14	15	16	13	13	14	15	15	16	16	16	15	15	138	286	
DSM, Class 2 Total	148	160	123	124	129	114	103	112	118	127	103	103	104	104	102	97	97	93	82	83	1,258	2,225	
Battery Storage - East	-	8.0	-	-	-	-	-	-	-	-	-	-	-	-	-	-	-	-	-	-	8	8	
Geothermal, Greenfield - East	-	30.0	-	-	-	-	-	-	-	-	-	-	-	-	-	-	-	-	-	-	30.0	30.0	
FOT Mona Q3	711	458	358	283	277	281	-	-	-	-	-	-	-	286	229	300	299	299	250	165	237	210	
Existing Plant Retirements/Conversions	(222)	-	-	57	-	-	-	-	-	-	-	-	-	(762)	-	(1,144)	(77)	-	(627)	-	-	-	
Annual Additions, Long Term Resources	148	213	166	169	129	131	103	112	118	127	103	103	104	527	102	1,282	123	93	1,140	83	-	-	
Annual Additions, Short Term Resources	711	458	358	283	277	281	-	-	-	-	-	-	-	286	229	300	299	299	250	165	-	-	
Total Annual Additions	859	672	525	452	406	412	103	112	118	127	103	103	104	813	331	1,582	422	392	1,390	248	-	-	

1/ Front office transaction amounts reflect one-year transaction periods, are not additive, and are reported as a 10/20-year annual average.

Case S-10_WCA		Capacity (MW)																				Resource Totals 1/	
		2015	2016	2017	2018	2019	2020	2021	2022	2023	2024	2025	2026	2027	2028	2029	2030	2031	2032	2033	2034	10-year	20-year
West	Existing Plant Retirements/Conversions	-	-	-	-	-	(512)	-	-	-	-	-	-	-	-	-	-	-	-	-	-	(512)	(512)
	Chehalis (Thermal Early Retirement/Conversions)	-	-	-	-	-	(512)	-	-	-	-	-	-	-	-	-	-	-	-	-	-	(512)	(512)
	Expansion Resources	-	-	-	-	-	-	-	-	-	-	-	-	-	-	-	-	-	-	-	-	-	-
	IC Aero PO	-	-	-	-	-	106	-	-	-	-	-	-	-	-	-	-	-	-	-	-	106	106
	IC Aero WV	-	-	-	-	-	-	-	-	101	-	-	-	-	-	-	-	-	-	-	-	101	101
	Oregon Solar Capacity Standard	-	7	-	-	-	-	-	-	-	-	-	-	-	-	-	-	-	-	-	-	7	7
	DSM, Class 1, OR-Curtail	-	-	10.6	10.6	-	-	-	10.6	-	-	-	-	-	-	-	-	-	-	-	-	31.8	31.8
	DSM, Class 1, OR-DLC-RES	-	-	-	-	-	-	-	-	-	-	-	-	-	-	-	-	-	-	-	3.0	11.2	14.2
	DSM, Class 1, OR-Irrigate	-	-	-	-	5.0	-	-	-	-	-	-	-	-	-	-	-	-	3.4	-	-	5.0	8.4
	DSM, Class 1 Total	-	-	10.6	10.6	5.0	-	-	10.6	-	-	-	-	-	-	-	-	-	3.4	3.0	11.2	36.8	54.4
	DSM, Class 2, CA	1	2	2	2	2	1	1	2	2	2	1	1	1	1	1	1	1	1	1	1	16	29
	DSM, Class 2, OR	44	39	35	32	29	27	25	25	23	23	21	21	22	22	21	20	20	20	19	19	302	507
	DSM, Class 2, WA	8	9	10	10	10	9	10	10	11	11	9	9	9	9	9	8	8	8	8	7	97	179
	DSM, Class 2 Total	54	49	47	44	42	38	36	36	36	35	31	31	32	32	32	29	29	29	28	28	415	715
	Battery Storage - West	-	-	1	-	1	-	-	-	-	-	-	-	-	-	-	-	-	-	-	-	2	2
	FOT Mid Columbia Flat	-	-	-	-	-	38	125	202	29	57	72	114	119	117	137	197	189	196	192	233	45	101
	FOT COB - Jan	-	-	-	-	-	297	297	297	297	297	297	297	297	297	297	297	297	297	297	297	149	223
	FOT MidColumbia - Jan	400	400	400	400	400	400	400	400	400	400	400	400	400	400	400	400	400	400	400	400	400	400
	FOT MidColumbia - Jan - 2	51	77	281	253	336	375	375	375	375	375	375	375	375	375	375	375	375	375	375	375	287	331
	FOT NOB - Jan	100	76	100	100	100	100	100	100	100	100	100	100	100	100	100	100	100	100	100	100	98	99
Existing Plant Retirements/Conversions	-	-	-	-	-	(512)	-	-	-	-	-	-	-	-	-	-	-	-	-	-	-	-	
Annual Additions, Long Term Resources	54	56	58	55	48	144	36	47	136	35	31	31	32	32	32	29	29	33	31	39	-	-	
Annual Additions, Short Term Resources	551	553	781	753	836	1,210	1,298	1,374	1,201	1,229	1,244	1,286	1,291	1,289	1,309	1,369	1,361	1,368	1,364	1,405	-	-	
Total Annual Additions	605	609	839	807	884	1,354	1,333	1,421	1,338	1,264	1,275	1,317	1,322	1,321	1,340	1,399	1,390	1,401	1,395	1,444	-	-	

1/ Front office transaction amounts reflect one-year transaction periods, are not additive, and are reported as a 10/20-year annual average.

Case S-10_System		Capacity (MW)																				Resource Totals 1/				
		2015	2016	2017	2018	2019	2020	2021	2022	2023	2024	2025	2026	2027	2028	2029	2030	2031	2032	2033	2034	10-year	20-year			
East	Existing Plant Retirements/Conversions	-	-	-	-	-	-	-	-	-	-	-	-	-	-	-	-	(45)	-	-	-	-	-	-	(45)	
	Hayden 1	-	-	-	-	-	-	-	-	-	-	-	-	-	-	-	-	-	(33)	-	-	-	-	-	-	(33)
	Hayden 2	-	-	-	-	-	-	-	-	-	-	-	-	-	-	-	-	-	-	-	-	-	-	-	-	-
	Hunter 2 (Coal Early Retirement/Conversions)	-	-	-	-	-	-	-	-	-	-	-	-	-	-	-	-	-	-	-	(269)	-	-	-	-	(269)
	Huntington 2 (Coal Early Retirement/Conversions)	-	-	-	-	-	-	-	-	-	-	-	-	-	-	-	-	(450)	-	-	-	-	-	-	-	(450)
	Carbon 1 (Coal Early Retirement/Conversions)	(67)	-	-	-	-	-	-	-	-	-	-	-	-	-	-	-	-	-	-	-	-	-	-	(67)	(67)
	Carbon 2 (Coal Early Retirement/Conversions)	(105)	-	-	-	-	-	-	-	-	-	-	-	-	-	-	-	-	-	-	-	-	-	-	(105)	(105)
	Cholla 4 (Coal Early Retirement/Conversions)	-	-	-	-	-	-	-	-	-	-	-	(387)	-	-	-	-	-	-	-	-	-	-	-	-	(387)
	DaveJohnston 1	-	-	-	-	-	-	-	-	-	-	-	-	-	-	(106)	-	-	-	-	-	-	-	-	-	(106)
	DaveJohnston 2	-	-	-	-	-	-	-	-	-	-	-	-	-	-	(106)	-	-	-	-	-	-	-	-	-	(106)
	DaveJohnston 3	-	-	-	-	-	-	-	-	-	-	-	-	-	-	(220)	-	-	-	-	-	-	-	-	-	(220)
	DaveJohnston 4	-	-	-	-	-	-	-	-	-	-	-	-	-	-	(330)	-	-	-	-	-	-	-	-	-	(330)
	Naughton 1	-	-	-	-	-	-	-	-	-	-	-	-	-	-	-	(156)	-	-	-	-	-	-	-	-	(156)
	Naughton 2	-	-	-	-	-	-	-	-	-	-	-	-	-	-	-	(201)	-	-	-	-	-	-	-	-	(201)
	Naughton 3 (Coal Early Retirement/Conversions)	(50)	-	-	(280)	-	-	-	-	-	-	-	-	-	-	-	-	-	-	-	-	-	-	-	(330)	(330)
	Gadsby 1-6	-	-	-	-	-	-	-	-	-	-	-	-	-	-	-	-	-	-	-	(358)	-	-	-	-	(358)
	Coal Ret. AZ - Gas RePower	-	-	-	-	-	-	-	-	-	-	-	387	-	-	-	-	-	-	-	-	-	-	-	-	387
	Coal Ret. WY - Gas RePower	-	-	-	337	-	-	-	-	-	-	-	-	-	-	-	-	-	(337)	-	-	-	-	-	337	-
	Expansion Resources																									
		CCCT - DJohns - F 1x1	-	-	-	-	-	-	-	-	-	-	-	-	-	-	-	313	-	-	-	-	-	-	-	313
		CCCT - DJohns - J 1x1	-	-	-	-	-	-	-	-	-	-	-	-	-	423	-	-	-	-	-	-	-	-	-	423
		CCCT - Utah-N - F 2x1	-	-	-	-	-	-	-	-	-	-	-	-	-	-	-	-	-	-	635	-	-	-	-	635
		CCCT - Utah-N - J 1x1	-	-	-	-	-	-	-	-	-	-	-	-	-	-	-	-	-	-	-	-	423	-	-	423
		CCCT - Utah-S - J 1x1	-	-	-	-	-	-	-	-	-	-	-	-	-	-	-	846	-	-	-	-	-	-	-	846
		Total CCCT	-	-	-	-	-	-	-	-	-	-	-	-	-	423	-	1,159	-	-	635	423	-	-	-	2,640
		DSM, Class 2, ID	4	4	5	5	5	4	4	4	5	5	5	5	5	5	5	4	4	4	4	4	4	4	45	91
	DSM, Class 2, UT	69	78	84	86	92	81	84	90	91	93	75	80	80	80	79	73	73	73	73	71	847	1,603			
	DSM, Class 2, WY	6	8	10	12	14	12	13	14	15	16	13	13	14	15	15	15	15	16	17	17	121	271			
	DSM, Class 2 Total	79	90	99	102	111	97	101	108	110	115	92	98	98	99	98	92	93	94	94	92	1,013	1,964			
	FOT Mona Q3	-	-	-	-	-	-	-	-	-	-	-	-	-	184	56	144	138	300	300	300	-	-	-	71	
West	Expansion Resources																									
		Oregon Solar Capacity Standard	-	7	-	-	-	-	-	-	-	-	-	-	-	-	-	-	-	-	-	-	-	-	7	7
		DSM, Class 2, CA	1	2	2	2	2	1	1	2	2	2	1	1	1	1	1	1	1	1	1	1	1	16	29	
		DSM, Class 2, OR	44	39	36	32	29	27	25	25	23	23	21	22	22	22	21	21	21	21	20	19	303	511		
		DSM, Class 2, WA	8	9	10	10	11	9	9	10	11	11	9	9	9	9	8	8	8	8	8	7	98	180		
		DSM, Class 2 Total	54	49	47	44	42	38	36	36	36	35	31	32	32	32	31	30	30	30	28	28	416	721		
		FOT COB Q3	-	62	29	-	60	104	-	-	-	-	-	-	-	268	268	268	268	268	223	165	25	99		
		FOT MidColumbia Q3	400	400	400	400	400	400	400	400	400	400	400	400	400	400	400	400	400	400	400	400	400	400	400	
		FOT MidColumbia Q3 - 2	227	375	375	370	375	375	160	198	196	162	248	290	357	375	375	375	375	375	375	375	375	281	317	
		FOT NOB Q3	100	100	100	100	100	100	100	100	100	100	100	100	100	100	100	100	100	100	100	100	100	100	100	
	Existing Plant Retirements/Conversions		(222)	-	-	57	-	-	-	-	-	-	-	-	-	(762)	-	(1,144)	(77)	-	(627)	-	-	-	-	
Annual Additions, Long Term Resources		133	147	146	146	153	135	137	144	146	149	123	130	130	555	129	1,282	123	124	757	543	-	-	-		
Annual Additions, Short Term Resources		727	937	904	870	935	979	660	698	696	662	748	790	857	1,327	1,199	1,287	1,280	1,443	1,398	1,340	-	-	-		
Total Annual Additions		860	1,084	1,050	1,016	1,088	1,113	797	843	842	811	871	920	988	1,881	1,328	2,569	1,403	1,567	2,155	1,883	-	-	-		

1/ Front office transaction amounts reflect one-year transaction periods, are not additive, and are reported as a 10/20-year annual average.

Case S-11		Capacity (MW)																				Resource Totals 1/	
		2015	2016	2017	2018	2019	2020	2021	2022	2023	2024	2025	2026	2027	2028	2029	2030	2031	2032	2033	2034	10-year	20-year
East	Existing Plant Retirements/Conversions																						
	Hayden 1	-	-	-	-	-	-	-	-	-	-	-	-	-	-	-	-	-	(45)	-	-	-	(45)
	Hayden 2	-	-	-	-	-	-	-	-	-	-	-	-	-	-	-	-	-	(33)	-	-	-	(33)
	Hunter 2 (Coal Early Retirement/Conversions)	-	-	-	-	-	-	-	-	-	-	-	-	-	-	-	-	-	-	-	(269)	-	(269)
	Huntington 2 (Coal Early Retirement/Conversions)	-	-	-	-	-	-	-	-	(450)	-	-	-	-	-	-	-	-	-	-	-	-	(450)
	Carbon 1 (Coal Early Retirement/Conversions)	(67)	-	-	-	-	-	-	-	-	-	-	-	-	-	-	-	-	-	-	-	-	(67)
	Carbon 2 (Coal Early Retirement/Conversions)	(105)	-	-	-	-	-	-	-	-	-	-	-	-	-	-	-	-	-	-	-	-	(105)
	Cholla 4 (Coal Early Retirement/Conversions)	-	-	-	-	-	-	-	-	-	-	(387)	-	-	-	-	-	-	-	-	-	-	(387)
	DaveJohnston 1 (Coal Early Retirement/Conversions)	-	-	-	-	(106)	-	-	-	-	-	-	-	-	-	-	-	-	-	-	-	-	(106)
	DaveJohnston 2	-	-	-	-	-	-	-	-	-	-	-	-	-	-	(106)	-	-	-	-	-	-	(106)
	DaveJohnston 3	-	-	-	-	-	-	-	-	-	-	-	-	-	-	(220)	-	-	-	-	-	-	(220)
	DaveJohnston 4	-	-	-	-	-	-	-	-	-	-	-	-	-	-	-	-	-	-	-	(330)	-	(330)
	Naughton 1	-	-	-	-	-	-	-	-	-	-	-	-	-	-	-	-	(156)	-	-	-	-	(156)
	Naughton 2	-	-	-	-	-	-	-	-	-	-	-	-	-	-	-	(201)	-	-	-	-	-	(201)
	Naughton 3 (Coal Early Retirement/Conversions)	(50)	-	-	(280)	-	-	-	-	-	-	-	-	-	-	-	-	-	-	-	-	-	(330)
	Gadsby 1-6	-	-	-	-	-	-	-	-	-	-	-	-	-	-	-	-	-	-	-	(358)	-	(358)
	Coal Ret_ AZ - Gas RePower	-	-	-	-	-	-	-	-	-	-	-	387	-	-	-	-	-	-	-	-	-	387
	Coal Ret_ WY - Gas RePower	-	-	-	337	-	-	-	-	-	-	-	-	-	-	-	(337)	-	-	-	-	-	337
	Expansion Resources																						
	CCCT - Dlohns - F 1xl	-	-	-	-	-	-	-	-	-	-	-	-	-	-	-	-	-	-	313	-	-	313
	CCCT - Huntington - J 1xl	-	-	-	-	-	-	-	-	-	-	423	-	-	-	-	-	-	-	-	-	-	423
	CCCT - Naughton - J 1xl	-	-	-	-	-	-	-	-	-	-	-	-	-	-	-	401	-	-	-	-	-	401
	CCCT - Utah-N - J 1xl	-	-	-	-	-	-	-	-	-	-	-	-	-	423	-	-	-	-	-	-	-	423
	Total CCCT	-	-	-	-	-	-	-	-	-	-	423	-	-	423	-	-	401	-	-	313	-	1,560
	Modular-Nuclear-East	-	-	-	-	-	-	-	-	-	-	-	-	-	-	-	-	3,110	-	-	-	-	3,110
	Wind, DJohnston, 43	-	-	-	-	-	106	-	-	-	-	-	-	-	-	326	-	-	-	17	-	106	449
	Wind, CO, 3l	-	-	-	-	-	-	-	-	-	-	-	-	426	69	18	-	-	-	12	100	31	656
	Wind, UT, 3l	-	-	-	-	-	-	-	-	-	-	-	250	-	-	-	-	-	-	-	-	-	250
	Wind, WYAE, 43	-	-	-	-	-	-	-	-	-	-	-	-	-	-	389	-	-	-	-	-	-	389
	Total Wind	-	-	-	-	-	106	-	-	-	-	-	250	-	426	784	18	-	-	12	117	31	1,744
	Utility Solar - PV - East	-	-	-	-	-	-	-	-	-	750	-	-	-	-	-	-	-	-	-	-	-	750
	DSM, Class 2, ID	5	5	6	6	7	6	6	6	7	7	6	6	6	5	5	5	5	5	5	5	5	60
	DSM, Class 2, UT	80	91	100	101	110	99	103	107	109	109	89	89	88	88	85	79	78	77	76	75	1,009	1,835
DSM, Class 2, WY	8	9	12	14	16	15	15	17	18	19	15	15	16	16	16	16	16	17	17	17	141	303	
DSM, Class 2 Total	92	106	117	121	132	119	124	130	134	134	110	110	110	110	107	101	100	99	97	97	1,209		
FOT Mona Q3	-	-	-	-	-	-	-	-	27	-	-	-	-	-	-	-	-	-	-	-	-	3	
Existing Plant Retirements/Conversions																							
JimBridger 1 (Coal Early Retirement/Conversions)	-	-	-	-	-	-	-	-	-	-	(354)	-	-	-	-	-	-	-	-	-	-	(354)	
JimBridger 2 (Coal Early Retirement/Conversions)	-	-	-	-	-	-	-	-	-	-	-	-	-	-	-	-	-	-	-	(359)	-	(359)	
Expansion Resources																							
Modular-Nuclear-West	-	-	-	-	-	-	-	-	-	-	-	-	-	-	-	-	518	-	-	-	-	518	
Wind, WW, 29	-	-	-	-	-	-	-	-	-	-	-	-	38	376	33	92	-	18	-	10	-	567	
Total Wind	-	-	-	-	-	-	-	-	-	-	-	-	38	376	33	92	-	18	-	10	-	567	
Utility Solar - PV - West	-	-	-	-	-	-	-	-	-	-	339	66	-	-	-	-	-	-	-	-	-	405	
Oregon Solar Capacity Standard	-	-	7	-	-	-	-	-	-	-	-	-	-	-	-	-	-	-	-	-	7	7	
DSM, Class 1, OR-Curtail	-	-	-	-	-	-	-	-	10.6	-	-	-	10.6	-	-	-	-	-	-	-	10.6	31.8	
DSM, Class 1, OR-Irrigate	-	-	-	-	-	-	-	5.0	-	-	3.4	-	-	-	-	-	-	-	-	-	5.0	8.4	
DSM, Class 1 Total	-	-	-	-	-	-	-	5.0	10.6	-	3.4	10.6	-	-	-	-	-	-	-	-	15.6	40.2	
DSM, Class 2, CA	2	2	2	2	2	2	2	2	2	2	2	2	2	2	2	2	2	2	2	2	21	39	
DSM, Class 2, OR	47	42	40	37	36	34	31	39	36	35	33	33	33	32	32	29	28	29	27	27	376	679	
DSM, Class 2, WA	11	11	12	12	13	11	11	12	12	12	10	10	10	10	10	8	8	8	8	8	117	208	
DSM, Class 2 Total	60	55	54	51	51	46	44	52	51	50	45	46	45	45	43	39	38	38	37	36	514	927	
FOT COB Q3	-	67	106	53	198	206	-	268	254	-	-	-	-	-	-	-	-	-	-	-	115	58	
FOT MidColumbia Q3	400	400	400	400	400	400	400	400	400	400	400	400	400	400	400	400	400	-	-	-	400	320	
FOT MidColumbia Q3 - 2	215	375	375	375	375	375	248	375	375	264	293	193	88	5	15	156	-	-	-	-	335	205	
FOT NOB Q3	100	100	100	100	100	100	100	100	100	100	100	100	100	100	100	100	-	-	9	30	100	82	
Existing Plant Retirements/Conversions																					(222)	-	
Annual Additions, Long Term Resources																					152	168	
Annual Additions, Short Term Resources																					715	942	
Total Annual Additions																					866	1,110	

1/ Front office transaction amounts reflect one-year transaction periods, are not additive, and are reported as a 10/20-year annual average.

Case S-12		Capacity (MW)																			Resource Totals 1/							
		2015	2016	2017	2018	2019	2020	2021	2022	2023	2024	2025	2026	2027	2028	2029	2030	2031	2032	2033	2034	10-year	20-year					
East	Existing Plant Retirements/Conversions	-	-	-	-	-	-	-	-	-	-	-	-	-	-	-	-	-	(45)	-	-	-	-	-	-	-	-	(45)
	Hayden 1	-	-	-	-	-	-	-	-	-	-	-	-	-	-	-	-	-	-	(33)	-	-	-	-	-	-	-	(33)
	Hayden 2	-	-	-	-	-	-	-	-	-	-	-	-	-	-	-	-	-	-	-	-	-	-	-	-	-	-	(269)
	Hunter 2 (Coal Early Retirement/Conversions)	-	-	-	-	-	-	-	-	-	-	-	-	-	-	-	-	-	-	-	-	-	-	-	-	-	-	(450)
	Huntington 2 (Coal Early Retirement/Conversions)	-	-	-	-	-	-	-	-	-	-	-	-	-	-	-	-	-	-	-	-	-	-	-	-	-	-	(450)
	Carbon 1 (Coal Early Retirement/Conversions)	(67)	-	-	-	-	-	-	-	-	-	-	-	-	-	-	-	-	-	-	-	-	-	-	-	-	-	(67)
	Carbon 2 (Coal Early Retirement/Conversions)	(105)	-	-	-	-	-	-	-	-	-	-	-	-	-	-	-	-	-	-	-	-	-	-	-	-	-	(105)
	Cholla 4 (Coal Early Retirement/Conversions)	-	-	-	-	-	-	-	-	-	-	-	-	-	-	-	-	-	-	-	-	-	-	-	-	-	-	(387)
	DaveJohnston 1 (Coal Early Retirement/Conversions)	-	-	-	-	-	(106)	-	-	-	-	-	-	-	-	-	-	-	-	-	-	-	-	-	-	-	-	(106)
	DaveJohnston 2	-	-	-	-	-	-	-	-	-	-	-	-	-	-	-	-	-	-	-	-	-	-	-	-	-	-	(106)
	DaveJohnston 3	-	-	-	-	-	-	-	-	-	-	-	-	-	-	-	-	-	-	-	-	-	-	-	-	-	-	(220)
	DaveJohnston 4	-	-	-	-	-	-	-	-	-	-	-	-	-	-	-	-	-	-	-	-	-	-	-	-	-	-	(330)
	Naughton 1	-	-	-	-	-	-	-	-	-	-	-	-	-	-	-	-	-	-	-	-	-	-	-	-	-	-	(156)
	Naughton 2	-	-	-	-	-	-	-	-	-	-	-	-	-	-	-	-	-	-	-	-	-	-	-	-	-	-	(201)
	Naughton 3 (Coal Early Retirement/Conversions)	(50)	-	-	-	(280)	-	-	-	-	-	-	-	-	-	-	-	-	-	-	-	-	-	-	-	-	-	(330)
	Gadsby 1-6	-	-	-	-	-	-	-	-	-	-	-	-	-	-	-	-	-	-	-	-	-	-	-	-	-	-	(358)
	Coal Ret_AZ - Gas RePower	-	-	-	-	-	-	-	-	-	-	-	387	-	-	-	-	-	-	-	-	-	-	-	-	-	-	387
	Coal Ret_WY - Gas RePower	-	-	-	-	337	-	-	-	-	-	-	-	-	-	-	-	-	-	-	-	-	-	-	-	-	-	337
	Expansion Resources	-	-	-	-	-	-	-	-	-	-	-	-	-	-	-	-	-	-	-	-	-	-	-	-	-	-	-
	CCCT - DJohns - F 1x1	-	-	-	-	-	-	-	-	-	-	-	-	-	-	-	313	-	-	-	-	-	-	-	-	-	-	313
	CCCT - DJohns - J 1x1	-	-	-	-	-	-	-	-	-	-	-	-	-	-	-	-	-	-	-	-	-	-	-	-	-	-	423
	CCCT - Huntington - J 1x1	-	-	-	-	-	-	-	-	-	-	-	-	-	-	423	-	-	-	-	-	-	-	-	-	-	-	423
	CCCT - Naughton - J 1x1	-	-	-	-	-	-	-	-	-	-	-	-	-	-	-	-	-	-	-	-	-	-	-	-	-	-	401
	CCCT - Utah-S - J 1x1	-	-	-	-	-	-	-	-	-	-	-	-	-	-	-	-	-	-	-	-	-	-	-	-	-	-	846
	Total CCCT	-	-	-	-	-	-	-	-	-	-	-	-	-	-	423	313	-	-	-	-	-	-	-	-	-	-	2,406
	Wind, DJohnston, 43	-	-	-	-	-	-	-	-	-	-	-	-	-	-	-	-	-	-	-	-	-	-	-	-	-	-	26
	Total Wind	-	-	-	-	-	-	-	-	-	-	-	-	-	-	-	-	-	-	-	-	-	-	-	-	-	-	26
	Utility Solar - PV - East	-	-	-	-	-	-	-	-	-	-	-	-	-	-	-	-	-	-	-	-	-	-	-	-	-	-	154
	DSM, Class 1, ID-Irrigate	-	-	-	-	-	-	-	-	-	-	-	-	-	-	-	-	-	-	-	-	-	-	-	-	-	-	4.0
	DSM, Class 1 Total	-	-	-	-	-	-	-	-	-	-	-	-	-	-	-	-	-	-	-	-	-	-	-	-	-	-	4.0
	DSM, Class 2, ID	4	4	5	5	5	4	4	4	5	5	5	5	5	5	5	5	4	4	4	4	4	4	4	4	4	4	91
	DSM, Class 2, UT	69	78	84	86	92	81	86	90	92	93	75	81	80	80	81	75	74	73	71	73	850	1,612					
	DSM, Class 2, WY	7	8	10	12	14	12	13	14	15	16	13	13	14	15	15	15	15	16	17	17	121	270					
	DSM, Class 2 Total	79	90	99	102	111	97	103	108	112	114	92	99	99	99	100	94	94	93	92	94	1,016	1,973					
	FOT Mona Q3	-	-	-	-	-	-	-	-	18	40	140	172	194	44	170	44	80	47	75	300	300	20	81				
	West	Existing Plant Retirements/Conversions	-	-	-	-	-	-	-	-	-	-	-	-	-	-	-	-	-	-	-	-	-	-	-	-	-	(354)
		JimBridger 1 (Coal Early Retirement/Conversions)	-	-	-	-	-	-	-	-	-	-	-	-	-	-	-	-	-	-	-	-	-	-	-	-	-	(354)
JimBridger 2 (Coal Early Retirement/Conversions)		-	-	-	-	-	-	-	-	-	-	-	-	-	-	-	-	-	-	-	-	-	-	-	-	-	(359)	
Expansion Resources		-	-	-	-	-	-	-	-	-	-	-	-	-	-	-	-	-	-	-	-	-	-	-	-	-	-	
Wind, YK, 29		-	-	-	-	-	-	-	-	-	-	-	-	-	-	-	-	-	-	-	-	-	-	-	-	-	6	
Total Wind		-	-	-	-	-	-	-	-	-	-	-	-	-	-	-	-	-	-	-	-	-	-	-	-	-	6	
Utility Solar - PV - West		-	-	-	-	-	-	-	-	-	-	-	-	-	-	-	-	-	-	-	-	-	-	-	-	-	605	
Oregon Solar Capacity Standard		-	-	7	-	-	-	-	-	-	-	-	-	-	-	-	-	-	-	-	-	-	-	-	-	-	7	
DSM, Class 1, OR-Curtail		-	-	-	-	-	-	-	-	-	-	-	10.6	-	-	-	-	-	-	-	-	-	-	-	-	-	-	10.6
DSM, Class 1, OR-Irrigate		-	-	-	-	-	-	-	-	5.0	3.4	-	-	-	-	-	-	-	-	-	-	-	-	-	-	-	8.4	
DSM, Class 1 Total		-	-	-	-	-	-	-	-	5.0	3.4	-	10.6	-	-	-	-	-	-	-	-	-	-	-	-	-	-	8.4
DSM, Class 2, CA		1	2	2	2	2	1	1	2	2	2	1	1	1	1	1	1	1	1	1	1	16	29					
DSM, Class 2, OR		44	39	35	32	29	27	25	25	23	23	21	22	22	22	21	20	20	21	20	19	303	510					
DSM, Class 2, WA		8	9	10	10	11	9	10	10	11	11	9	9	9	9	9	8	8	8	8	7	98	181					
DSM, Class 2 Total		54	50	47	44	42	38	36	36	36	35	31	32	32	32	31	30	29	30	28	28	417	720					
FOT COB Q3		-	70	139	89	251	244	-	268	268	268	268	268	220	268	105	268	268	147	128	268	160	190					
FOT MidColumbia Q3		400	400	400	400	400	400	400	400	400	400	400	400	400	400	400	400	400	400	400	400	400	400	400	400	400	400	
FOT MidColumbia Q3 - 2		224	375	375	375	375	375	282	375	375	375	375	375	375	375	375	375	375	375	375	375	351	363					
FOT NOB Q3		100	100	100	100	100	100	100	100	100	100	100	100	100	100	100	100	100	100	100	100	100	100	100	100	100	100	
Existing Plant Retirements/Conversions	(222)	-	-	57	(106)	-	-	-	-	(450)	-	-	-	-	-	-	-	-	-	-	-	-	-	-	-	-	-	
Annual Additions, Long Term Resources	133	147	146	146	153	135	139	149	410	149	133	131	553	445	132	547	123	654	944	916								
Annual Additions, Short Term Resources	724	945	1,014	964	1,126	1,119	782	1,161	1,183	1,283	1,315	1,336	1,139	1,312	1,024	1,223	1,190	1,097	1,303	1,443								
Total Annual Additions	857	1,092	1,160	1,111	1,279	1,253	921	1,310	1,593	1,433	1,448	1,467	1,692	1,758	1,156	1,770	1,312	1,752	2,247	2,359								

1/ Front office transaction amounts reflect one-year transaction periods, are not additive, and are reported as a 10/20-year annual average.

Case S-13		Capacity (MW)																			Resource Totals 1/					
		2015	2016	2017	2018	2019	2020	2021	2022	2023	2024	2025	2026	2027	2028	2029	2030	2031	2032	2033	2034	10-year	20-year			
East	Existing Plant Retirements/Conversions	-	-	-	-	-	-	-	-	-	-	-	-	-	-	-	-	(45)	-	-	-	-	(45)			
	Hayden 1	-	-	-	-	-	-	-	-	-	-	-	-	-	-	-	-	-	(45)	-	-	-	-	(45)		
	Hayden 2	-	-	-	-	-	-	-	-	-	-	-	-	-	-	-	-	-	(33)	-	-	-	-	(33)		
	Hunter 2 (Coal Early Retirement/Conversions)	-	-	-	-	-	-	-	-	-	-	-	-	-	-	-	-	-	-	-	(269)	-	-	(269)		
	Huntington 2 (Coal Early Retirement/Conversions)	-	-	-	-	-	-	-	-	(450)	-	-	-	-	-	-	-	-	-	-	-	-	-	(450)	(450)	(450)
	Carbon 1 (Coal Early Retirement/Conversions)	(67)	-	-	-	-	-	-	-	-	-	-	-	-	-	-	-	-	-	-	-	-	-	(67)	(67)	(67)
	Carbon 2 (Coal Early Retirement/Conversions)	(105)	-	-	-	-	-	-	-	-	-	-	-	-	-	-	-	-	-	-	-	-	-	(105)	(105)	(105)
	Cholla 4 (Coal Early Retirement/Conversions)	-	-	-	-	-	-	-	-	-	-	(387)	-	-	-	-	-	-	-	-	-	-	-	(387)	(387)	(387)
	DaveJohnston 1 (Coal Early Retirement/Conversions)	-	-	-	-	(106)	-	-	-	-	-	-	-	-	-	-	-	-	-	-	-	-	-	(106)	(106)	(106)
	DaveJohnston 2	-	-	-	-	-	-	-	-	-	-	-	-	-	(106)	-	-	-	-	-	-	-	-	(106)	(106)	(106)
	DaveJohnston 3	-	-	-	-	-	-	-	-	-	-	-	-	-	(220)	-	-	-	-	-	-	-	-	(220)	(220)	(220)
	DaveJohnston 4	-	-	-	-	-	-	-	-	-	-	-	-	-	-	-	-	-	-	-	(330)	-	-	(330)	(330)	(330)
	Naughton 1	-	-	-	-	-	-	-	-	-	-	-	-	-	-	-	(156)	-	-	-	-	-	-	(156)	(156)	(156)
	Naughton 2	-	-	-	-	-	-	-	-	-	-	-	-	-	-	-	(201)	-	-	-	-	-	-	(201)	(201)	(201)
	Naughton 3 (Coal Early Retirement/Conversions)	(50)	-	-	(280)	-	-	-	-	-	-	-	-	-	-	-	-	-	-	-	-	-	-	(330)	(330)	(330)
	Gadsby 1-6	-	-	-	-	-	-	-	-	-	-	-	-	-	-	-	-	-	-	-	(358)	-	-	(358)	(358)	(358)
	Coal Ret_AZ - Gas RePower	-	-	-	-	-	-	-	-	-	-	387	-	-	-	-	-	-	-	-	-	-	-	387	387	387
	Coal Ret_WY - Gas RePower	-	-	-	337	-	-	-	-	-	-	-	-	-	-	-	-	(337)	-	-	-	-	-	337	337	337
	Expansion Resources																									
	CCCT - DJohns - F 1xl	-	-	-	-	-	-	-	-	-	-	-	-	-	313	-	-	-	-	-	-	-	-	313	313	313
	CCCT - DJohns - J 1xl	-	-	-	-	-	-	-	-	-	-	-	-	-	-	-	-	-	-	423	-	-	-	423	423	423
	CCCT - Huntington - J 1xl	-	-	-	-	-	-	-	-	-	-	-	-	-	-	-	-	423	-	-	-	-	-	423	423	423
	CCCT - Naughton - J 1xl	-	-	-	-	-	-	-	-	-	-	-	-	-	-	-	-	-	-	401	-	-	-	401	401	401
	CCCT - Utah-N - F 2xl	-	-	-	-	-	-	-	-	-	-	-	-	-	-	-	-	-	-	635	-	-	-	635	635	635
	CCCT - Utah-S - J 1xl	-	-	-	-	-	-	-	-	-	-	-	-	423	-	-	-	-	-	423	-	-	-	423	423	423
	Total CCCT	-	-	-	-	-	-	-	-	-	-	-	-	423	313	-	423	-	401	1,481	-	-	-	3,041	3,041	3,041
	Wind, DJohnston, 43	-	-	-	-	-	25	-	-	-	-	-	-	-	-	-	-	-	-	-	-	-	-	25	25	25
	Total Wind	-	-	-	-	-	25	-	-	-	-	-	-	-	-	-	-	-	-	-	-	-	-	25	25	25
	Utility Solar - PV - East	-	-	-	-	-	154	-	-	-	-	-	-	-	-	-	-	-	-	-	-	-	-	154	154	154
	DSM, Class 1, UT-DLC-RES	-	-	-	-	-	-	-	-	-	-	-	-	-	-	-	-	-	-	-	-	-	-	4.9	4.9	4.9
	DSM, Class 1 Total	-	-	-	-	-	-	-	-	-	-	-	-	-	-	-	-	-	-	-	-	-	-	4.9	4.9	4.9
	DSM, Class 2, ID	4	4	5	5	5	4	4	4	5	5	5	5	5	5	5	5	4	4	4	4	4	4	45	90	90
	DSM, Class 2, UT	69	78	84	86	92	81	84	90	94	93	75	77	80	80	77	73	66	65	66	69	69	850	1,577	1,577	
	DSM, Class 2, WY	7	8	10	12	14	12	13	14	15	16	13	13	14	15	15	15	14	15	15	16	16	121	266	266	
	DSM, Class 2 Total	79	90	99	102	111	97	101	108	113	115	92	95	99	99	97	92	84	84	85	89	89	1,016	1,933	1,933	
	CAES - East	-	-	-	-	-	-	-	-	-	300.0	-	-	-	-	-	-	-	-	-	-	-	-	300.0	300.0	300.0
	FOT Mona Q3	-	-	-	-	-	9	-	-	122	103	119	197	229	44	73	44	255	244	143	75	300	35	98	98	98
	Existing Plant Retirements/Conversions																									
	JimBridger 1 (Coal Early Retirement/Conversions)	-	-	-	-	-	-	-	-	-	-	(354)	-	-	-	-	-	-	-	-	-	-	-	(354)	(354)	(354)
	JimBridger 2 (Coal Early Retirement/Conversions)	-	-	-	-	-	-	-	-	-	-	-	-	-	-	-	-	-	-	-	(359)	-	-	(359)	(359)	(359)
	Expansion Resources																									
	Wind, YK, 29	-	-	-	-	-	-	-	-	-	-	29	-	-	-	-	-	-	-	-	-	-	-	29	29	29
	Total Wind	-	-	-	-	-	-	-	-	-	-	29	-	-	-	-	-	-	-	-	-	-	-	29	29	29
	Oregon Solar Capacity Standard	-	7	-	-	-	-	-	-	-	-	-	-	-	-	-	-	-	-	-	-	-	-	7	7	7
	DSM, Class 1, OR-Curtail	-	-	-	-	-	-	-	-	-	10.6	-	-	10.6	-	-	-	-	-	-	10.6	-	-	10.6	10.6	10.6
	DSM, Class 1, OR-Irrigate	-	-	-	-	-	-	-	-	5.0	-	-	-	-	-	-	-	3.4	-	-	-	-	-	5.0	5.0	5.0
	DSM, Class 1 Total	-	-	-	-	-	-	-	-	5.0	10.6	-	-	10.6	-	-	-	3.4	10.6	-	-	-	-	15.6	15.6	15.6
DSM, Class 2, CA	1	2	2	2	2	1	1	2	2	2	1	1	1	1	1	1	1	1	1	1	1	16	29	29		
DSM, Class 2, OR	44	39	36	32	29	27	25	25	23	23	21	22	22	22	21	21	20	20	19	19	19	303	509	509		
DSM, Class 2, WA	8	9	10	10	11	9	10	10	11	11	9	9	9	9	9	8	8	8	8	7	7	98	180	180		
DSM, Class 2 Total	54	49	47	44	42	38	36	36	36	35	31	32	32	32	31	30	29	29	27	27	27	417	718	718		
FOT COB Q3	-	93	148	113	268	260	-	268	268	268	268	268	150	268	169	268	268	189	128	212	169	194	194	194		
FOT MidColumbia Q3	400	400	400	400	400	400	400	400	400	400	400	400	400	400	400	400	400	400	400	400	400	400	400	400		
FOT MidColumbia Q3 - 2	227	375	375	375	375	375	313	375	375	375	375	375	375	375	375	375	375	375	375	375	375	354	364	364		
FOT NOB Q3	100	100	100	100	100	100	100	100	100	100	100	100	100	100	100	100	100	100	100	100	100	100	100	100		
Existing Plant Retirements/Conversions	(222)	-	-	57	(106)	-	-	(450)	-	(354)	-	-	-	(326)	-	(694)	(77)	-	(1,316)	-	-	-	-	-		
Annual Additions, Long Term Resources	133	147	146	146	153	314	137	149	160	450	153	138	553	445	128	548	124	513	1,593	122	-	-	122	122		
Annual Additions, Short Term Resources	727	968	1,023	988	1,152	1,135	813	1,265	1,246	1,262	1,339	1,372	1,069	1,216	1,088	1,397	1,387	1,206	1,078	1,387	-	-	1,387	1,387		
Total Annual Additions	860	1,114	1,169	1,134	1,305	1,449	950	1,415	1,405	1,711	1,492	1,510	1,622	1,661	1,216	1,946	1,511	1,720	2,671	1,508	-	-	1,508	1,508		

1/ Front office transaction amounts reflect one-year transaction periods, are not additive, and are reported as a 10/20-year annual average.

Case S-14		Capacity (MW)																			Resource Totals 1/			
		2015	2016	2017	2018	2019	2020	2021	2022	2023	2024	2025	2026	2027	2028	2029	2030	2031	2032	2033	2034	10-year	20-year	
East	Existing Plant Retirements/Conversions	Hayden 1	-	-	-	-	-	-	-	-	-	-	-	-	-	-	-	-	(45)	-	-	-	-	(45)
		Hayden 2	-	-	-	-	-	-	-	-	-	-	-	-	-	-	-	-	-	(33)	-	-	-	-
	Hunter 2 (Coal Early Retirement/Conversions)	-	-	-	-	-	-	-	-	-	-	-	-	-	-	-	-	-	-	-	-	(269)	-	(269)
	Huntington 2 (Coal Early Retirement/Conversions)	-	-	-	-	-	-	-	-	(450)	-	-	-	-	-	-	-	-	-	-	-	-	-	(450)
	Carbon 1 (Coal Early Retirement/Conversions)	(67)	-	-	-	-	-	-	-	-	-	-	-	-	-	-	-	-	-	-	-	-	-	(67)
	Carbon 2 (Coal Early Retirement/Conversions)	(105)	-	-	-	-	-	-	-	-	-	-	-	-	-	-	-	-	-	-	-	-	-	(105)
	Cholla 4 (Coal Early Retirement/Conversions)	-	-	-	-	-	-	-	-	-	-	-	-	(387)	-	-	-	-	-	-	-	-	-	(387)
	DaveJohnston 1 (Coal Early Retirement/Conversions)	-	-	-	-	-	(106)	-	-	-	-	-	-	-	-	-	-	-	-	-	-	-	-	(106)
	DaveJohnston 2	-	-	-	-	-	-	-	-	-	-	-	-	-	-	-	-	-	-	(106)	-	-	-	(106)
	DaveJohnston 3	-	-	-	-	-	-	-	-	-	-	-	-	-	-	-	-	-	-	(220)	-	-	-	(220)
	DaveJohnston 4	-	-	-	-	-	-	-	-	-	-	-	-	-	-	-	-	-	-	-	-	(330)	-	(330)
	Naughton 1	-	-	-	-	-	-	-	-	-	-	-	-	-	-	-	-	-	-	-	-	-	-	(156)
	Naughton 2	-	-	-	-	-	-	-	-	-	-	-	-	-	-	-	-	-	-	(201)	-	-	-	(201)
	Naughton 3 (Coal Early Retirement/Conversions)	(50)	-	-	-	-	(280)	-	-	-	-	-	-	-	-	-	-	-	-	-	-	-	-	(330)
	Goodsby 1-6	-	-	-	-	-	-	-	-	-	-	-	-	-	-	-	-	-	-	-	-	(358)	-	(358)
	Coal Ret. A-Z - Gas RePower	-	-	-	-	-	-	-	-	-	-	-	-	-	387	-	-	-	-	-	-	-	-	387
	Coal Ret. W-Y - Gas RePower	-	-	-	-	337	-	-	-	-	-	-	-	-	-	-	-	-	-	-	-	-	-	337
	Expansion Resources		-	-	-	-	-	-	-	-	-	-	-	-	-	-	-	-	-	-	-	-	-	-
	CCCT - DJohns - F 1x1	-	-	-	-	-	-	-	-	-	-	-	-	-	-	-	313	-	-	-	-	-	-	313
	CCCT - DJohns - J 1x1	-	-	-	-	-	-	-	-	-	-	-	-	-	-	-	-	-	-	-	-	423	-	423
	CCCT - Huntington - J 1x1	-	-	-	-	-	-	-	-	-	-	-	-	-	-	-	-	-	-	-	-	-	423	423
	CCCT - Naughton - J 1x1	-	-	-	-	-	-	-	-	-	-	-	-	-	-	-	-	-	-	-	-	-	401	401
	CCCT - Utah-N - F 2x1	-	-	-	-	-	-	-	-	-	-	-	-	-	-	-	-	-	-	-	-	-	635	635
	CCCT - Utah-S - J 1x1	-	-	-	-	-	-	-	-	-	-	423	-	-	-	-	-	-	-	-	-	-	423	846
	Total CCCT	-	-	-	-	-	-	-	-	-	-	423	-	-	-	-	-	-	-	-	-	-	1,459	423
	Wind, DJohnston, 43	-	-	-	-	-	-	25	-	-	-	-	-	-	-	-	-	-	-	-	-	-	-	25
	Total Wind	-	-	-	-	-	-	25	-	-	-	-	-	-	-	-	-	-	-	-	-	-	-	25
Utility Solar - PV - East	-	-	-	-	-	-	108	-	-	-	-	-	-	-	-	-	-	-	-	-	-	46	108	
DSM, Class 3, ID-C&I Pricing	-	-	-	-	-	-	-	-	-	-	-	-	-	-	-	-	-	-	-	-	-	1.6	1.6	
DSM, Class 3, ID-C&I Demand Buyback	-	-	-	-	-	-	-	-	-	-	-	-	-	-	-	-	-	-	-	-	-	0.1	0.1	
DSM, Class 3, ID-Irrigate Price	-	-	-	-	-	-	-	-	-	-	-	-	-	-	-	-	-	-	-	-	-	1.8	1.8	
DSM, Class 3, ID-Res Price	-	-	-	-	-	-	-	-	-	-	-	-	-	-	-	-	-	-	-	-	-	2.7	2.7	
DSM, Class 3, UT-C&I Pricing	-	-	-	-	-	-	-	-	20.6	6.2	3.4	-	-	-	-	-	-	-	-	-	-	3.4	0.9	
DSM, Class 3, UT-C&I Demand Buyback	-	-	-	-	-	-	-	-	-	-	-	-	-	-	-	-	-	-	-	-	-	5.3	5.3	
DSM, Class 3, UT-Irrigate Price	-	-	-	-	-	-	-	-	-	-	-	-	-	-	-	-	-	-	-	-	-	0.8	0.8	
DSM, Class 3, UT-Res Price	-	-	-	-	-	-	-	-	-	-	-	-	-	-	-	-	-	-	-	-	-	69.4	69.4	
DSM, Class 3, WY-C&I Pricing	-	-	-	-	-	-	-	8.9	-	4.1	-	-	-	-	-	-	-	-	-	-	-	1.5	13.0	
DSM, Class 3, WY-C&I Demand Buyback	-	-	-	-	-	-	-	-	-	-	-	-	-	-	-	-	-	-	-	-	-	4.2	4.2	
DSM, Class 3, WY-Irrigate Price	-	-	-	-	-	-	-	-	-	-	-	-	-	-	-	-	-	-	-	-	-	0.3	0.3	
DSM, Class 3, WY-Res Price	-	-	-	-	-	-	-	-	-	-	-	-	-	-	-	-	-	-	-	-	-	9.7	9.7	
DSM, Class 1 Total	-	-	-	-	-	-	-	29.5	6.2	7.5	-	-	-	-	-	-	-	-	-	3.4	-	98.3	43.2	
DSM, Class 2, ID	4	4	5	5	5	4	4	4	5	6	5	5	5	5	5	4	4	4	4	4	4	4	46	
DSM, Class 2, UT	69	78	84	86	92	81	86	91	94	93	81	81	80	84	81	75	74	73	71	71	71	853	1,625	
DSM, Class 2, WY	7	8	10	12	14	12	13	14	15	16	13	13	14	15	15	15	15	16	17	17	17	122	273	
DSM, Class 2 Total	79	90	99	102	111	97	103	110	114	115	99	99	99	104	100	95	94	94	92	93	1,021	1,989		
FOT Mona Q3	-	-	-	-	-	-	-	-	75	60	-	-	56	88	151	294	163	98	80	238	217	300	14	
West																								
Existing Plant Retirements/Conversions																								
JimBridger 1 (Coal Early Retirement/Conversions)																						(354)		
JimBridger 2 (Coal Early Retirement/Conversions)																						(359)		
Expansion Resources																								
Wind, YK, 29																						79		
Total Wind																						79		
Oregon Solar Capacity Standard																						7		
DSM, Class 1, OR-Irrigate																						8.4		
DSM, Class 3, CA-C&I Pricing																						0.7		
DSM, Class 3, CA-Irrigate Price																						0.7		
DSM, Class 3, CA-Res Price																						1.6		
DSM, Class 3, OR-C&I Pricing																						0.2		
DSM, Class 3, OR-C&I Demand Buyback																						2.0		
DSM, Class 3, OR-Irrigate Price																						1.7		
DSM, Class 3, OR-Res Price																						29.9		
DSM, Class 3, WA-C&I Pricing																						1.1		
DSM, Class 3, WA-C&I Demand Buyback																						0.5		
DSM, Class 3, WA-Irrigate Price																						1.1		
DSM, Class 3, WA-Res Price																						8.3		
DSM, Class 1 Total																						27.6		
DSM, Class 2, CA		1	2	2	2	2	1	1	2	2	1	1	1	1	1	1	1	1	1	1	1	1	16	
DSM, Class 2, OR		44	39	36	32	29	27	25	25	23	22	22	22	22	21	21	21	21	20	21	21	303		
DSM, Class 2, WA		8	9	10	10	11	9	10	10	11	9	9	9	9	8	8	8	8	7	7	7	98		
DSM, Class 2 Total		54	49	47	44	42	38	36	36	36	35	32	32	32	32	31	30	30	30	28	29	417		
FOT COB Q3		-	93	141	105	268	268	-	268	268	249	268	268	268	268	268	268	268	175	259	166	212		
FOT MidColumbia Q3		400	400	400	400	400	400	400	400	400	400	400	400	400	400	400	400	400	400	400	400	400	400	
FOT MidColumbia Q3 - 2		226	375	375	375	375	375	321	375	375	375	375	375	375	375	375	375	375	375	375	375	355		
FOT NOB Q3		100	100	100	100	100	100	100	100	100	100	100	100	100	100	100	100	100	100	100	100	100		
Existing Plant Retirements/Conversions		(222)	-	-	57	(106)	-	-	(450)	-	(354)	-	-	-	(326)	-	(694)	(77)	-	(1,316)	-	-		
Annual Additions, Long Term Resources		133	147	154	146	153	268	139	265	156	580	136	139	135	449	132	977	133	127	1,579	294	-		
Annual Additions, Short Term Resources		726	968	1,016	980	1,143	1,143	821	1,218	1,203	1,124	1,199	1,231	1,294	1,437	1,306	1,241	1,223	1,381	1,267	1,434	-		
Total Annual Additions		860	1,114	1,169	1,127	1,296	1,411	960	1,483	1,359	1,705	1,334	1,370	1,429	1,886	1,438	2,218	1,357	1,509	2,846	1,728	-		

1/ Front office transaction amounts reflect one-year transaction periods, are not additive, and are reported as a 10/20-year annual average.

Case S-15		Capacity (MW)																				Resource Totals 1/					
		2015	2016	2017	2018	2019	2020	2021	2022	2023	2024	2025	2026	2027	2028	2029	2030	2031	2032	2033	2034	10-year	20-year				
East	Existing Plant Retirements/Conversions																										
	Hayden 1	-	-	-	-	-	-	-	-	-	-	-	-	-	-	-	-	-	-	(45)	-	-	(45)				
	Hayden 2	-	-	-	-	-	-	-	-	-	-	-	-	-	-	-	-	-	-	(33)	-	-	(33)				
	Hunter 2 (Thermal Early Retirement/Conversions)	-	-	-	-	-	-	-	-	-	-	-	-	-	-	-	-	-	-	-	-	(269)	-	(269)			
	Huntington 2 (Thermal Early Retirement/Conversions)	-	-	-	-	-	-	-	(450)	-	-	-	-	-	-	-	-	-	-	-	-	-	-	(450)	(450)		
	Carbon 1 (Thermal Early Retirement/Conversions)	(67)	-	-	-	-	-	-	-	-	-	-	-	-	-	-	-	-	-	-	-	-	-	(67)	(67)		
	Carbon 2 (Thermal Early Retirement/Conversions)	(105)	-	-	-	-	-	-	-	-	-	-	-	-	-	-	-	-	-	-	-	-	-	(105)	(105)		
	Cholla 4 (Thermal Early Retirement/Conversions)	-	-	-	-	-	-	-	-	-	-	(387)	-	-	-	-	-	-	-	-	-	-	-	-	(387)		
	DaveJohnston 1 (Thermal Early Retirement/Conversions)	-	-	-	-	(106)	-	-	-	-	-	-	-	-	-	-	-	-	-	-	-	-	-	(106)	(106)		
	DaveJohnston 2	-	-	-	-	-	-	-	-	-	-	-	-	-	(106)	-	-	-	-	-	-	-	-	-	(106)		
	DaveJohnston 3	-	-	-	-	-	-	-	-	-	-	-	-	-	(220)	-	-	-	-	-	-	-	-	-	(220)		
	DaveJohnston 4	-	-	-	-	-	-	-	-	-	-	-	-	-	-	-	-	-	-	-	-	(330)	-	(330)			
	Naughton 1	-	-	-	-	-	-	-	-	-	-	-	-	-	-	-	-	-	-	-	-	(156)	-	(156)			
	Naughton 2	-	-	-	-	-	-	-	-	-	-	-	-	-	-	-	-	-	-	-	-	(201)	-	(201)			
	Naughton 3 (Thermal Early Retirement/Conversions)	(50)	-	-	(280)	-	-	-	-	-	-	-	-	-	-	-	-	-	-	-	-	-	-	(330)	(330)		
	Gadsby 1-6	-	-	-	-	-	-	-	-	-	-	-	-	-	-	-	-	-	-	-	-	-	(358)	-	(358)		
	Coal Ret. AZ - Gas RePower	-	-	-	-	-	-	-	-	-	-	387	-	-	-	-	-	-	-	-	-	-	-	-	387		
	Coal Ret. WY - Gas RePower	-	-	-	337	-	-	-	-	-	-	-	-	-	-	-	-	(337)	-	-	-	-	-	-	337		
	Expansion Resources																										
	CCCT - DJohns - F 1x1	-	-	-	-	-	-	-	-	-	-	-	-	-	313	-	-	-	-	-	-	-	-	-	313		
	CCCT - DJohns - J 1x1	-	-	-	-	-	-	-	-	-	-	-	-	-	-	-	-	-	-	423	-	-	-	-	423		
	CCCT - Huntington - J 1x1	-	-	-	-	-	-	-	-	-	-	-	-	-	-	-	-	-	423	-	-	-	-	-	423		
	CCCT - Naughton - J 1x1	-	-	-	-	-	-	-	-	-	-	-	-	-	-	-	-	-	-	401	-	-	-	-	401		
	CCCT - Utah-N - F 2x1	-	-	-	-	-	-	-	-	-	-	-	-	-	-	-	-	-	-	-	-	-	635	-	635		
	CCCT - Utah-N - J 1x1	-	-	-	-	-	-	-	-	-	-	-	-	-	-	-	-	-	-	-	-	423	-	-	423		
	CCCT - Utah-S - J 1x1	-	-	-	-	-	-	-	-	-	423	-	-	-	-	-	-	-	-	-	-	423	-	-	423		
	Total CCCT	-	-	-	-	-	-	-	-	-	423	-	-	-	-	-	-	736	-	-	423	-	401	1,481	-	423	3,464
	Wind, DJohnston, 43	-	-	-	-	25	-	-	-	-	-	-	-	-	-	-	-	-	-	-	-	-	-	-	25	25	
	Total Wind	-	-	-	-	25	-	-	-	-	-	-	-	-	-	-	-	-	-	-	-	-	-	-	25	25	
	Utility Solar - PV - East	-	-	-	-	154	-	-	-	-	-	-	-	-	-	-	-	-	-	-	-	-	-	-	154	154	
	DSM, Class 1, ID-Irrigate	-	-	-	-	-	-	-	8.8	-	-	-	-	-	7.6	-	-	-	-	-	-	-	-	-	8.8	16.4	
	DSM, Class 1, UT-DLC-RES	-	-	-	-	-	-	-	37.2	-	-	-	-	-	-	-	-	-	-	-	-	-	10.0	-	37.2	47.2	
	DSM, Class 1, UT-Irrigate	-	-	-	-	-	-	-	13.2	-	-	-	-	-	-	-	-	-	-	-	-	-	-	-	13.2	13.2	
	DSM, Class 1 Total	-	-	-	-	-	-	-	59.2	-	-	-	-	-	7.6	-	-	-	-	-	-	-	10.0	-	59.2	76.7	
	DSM, Class 2, ID	4	4	5	6	7	5	6	6	6	6	5	5	5	4	5	4	4	4	4	4	4	4	4	54	99	
	DSM, Class 2, UT	80	89	96	102	108	96	100	104	106	105	85	85	86	72	70	65	65	63	62	64	64	64	985	1,701		
	DSM, Class 2, WY	7	9	10	12	14	13	14	16	15	17	14	15	15	14	14	14	14	15	15	15	15	15	127	271		
	DSM, Class 2 Total	90	102	111	119	129	114	120	126	127	128	104	105	106	90	88	83	84	82	81	83	83	1,167	2,070			
	FOT Mona Q3	-	-	-	-	-	261	-	283	262	173	247	274	293	77	-	276	275	95	-	255	-	-	98	139		
	West	Existing Plant Retirements/Conversions																									
		JimBridger 1 (Thermal Early Retirement/Conversions)	-	-	-	-	-	-	-	-	-	(354)	-	-	-	-	-	-	-	-	-	-	-	-	(354)	(354)	
		JimBridger 2 (Thermal Early Retirement/Conversions)	-	-	-	-	-	-	-	-	-	-	-	-	-	-	-	-	-	-	-	(359)	-	-	(359)	(359)	
		Chehalis	-	-	-	-	-	(465)	-	-	-	-	-	-	-	-	-	-	-	-	-	-	-	-	(465)	(465)	
		Expansion Resources																									
		IC Aero PO	-	-	-	-	-	106	-	-	-	-	-	-	-	-	-	-	-	-	-	-	-	-	106	106	
		Wind, YK, 29	-	-	-	-	-	-	-	-	-	27	-	-	-	-	-	-	-	-	-	-	-	-	-	27	27
		Total Wind	-	-	-	-	-	-	-	-	-	27	-	-	-	-	-	-	-	-	-	-	-	-	-	27	27
Oregon Solar Capacity Standard		-	7	-	-	-	-	-	-	-	-	-	-	-	-	-	-	-	-	-	-	-	-	-	7	7	
DSM, Class 1, CA-Curtail		-	-	-	-	-	-	-	-	-	-	-	-	-	-	-	-	-	-	-	-	-	-	1.0	1.0		
DSM, Class 1, CA-DLC-RES		-	-	-	-	-	-	-	-	-	-	-	-	-	-	-	-	-	-	-	-	-	-	2.6	2.6		
DSM, Class 1, CA-Irrigate		-	-	-	-	-	-	-	3.6	-	-	-	-	-	-	-	-	-	-	-	-	-	0.6	3.6	4.2		
DSM, Class 1, OR-Curtail		-	-	-	-	-	-	-	10.6	-	-	-	-	21.2	-	-	-	-	-	-	-	-	1.1	10.6	32.9		
DSM, Class 1, OR-DLC-RES		-	-	-	-	-	-	-	-	-	-	-	7.5	-	-	-	-	-	-	-	-	-	-	3.0	10.5		
DSM, Class 1, OR-Irrigate		-	-	-	-	-	-	8.4	-	-	-	-	-	-	-	-	-	-	-	-	-	-	0.3	8.4	8.7		
DSM, Class 1, WA-Curtail		-	-	-	-	-	-	-	-	-	-	-	-	6.2	-	-	-	-	-	-	-	-	3.0	0.3	9.5		
DSM, Class 1, WA-DLC-RES		-	-	-	-	-	-	-	-	-	-	-	-	-	-	-	-	-	-	-	-	-	-	3.7	3.7		
DSM, Class 1, WA-Irrigate		-	-	-	-	-	-	-	-	-	-	-	-	4.5	-	-	-	-	-	-	-	-	-	0.6	5.1		
DSM, Class 1 Total		-	-	-	-	-	-	-	22.6	-	-	-	7.5	31.8	-	-	-	-	-	-	-	-	3.0	13.1	22.6	78.1	
DSM, Class 2, CA		1	2	2	2	2	2	2	2	2	2	2	2	2	1	2	1	1	1	1	1	1	1	2	19	33	
DSM, Class 2, OR		44	40	37	34	30	30	28	28	26	25	23	26	25	23	22	21	21	23	27	27	27	27	322	559		
DSM, Class 2, WA		9	10	11	10	11	9	10	11	11	12	10	10	10	9	9	8	8	8	8	8	8	8	104	191		
DSM, Class 2 Total		55	52	49	47	44	41	39	40	39	39	34	37	37	34	33	30	30	32	36	36	36	36	445	783		
FOT COB Q3		-	73	118	69	219	268	229	268	268	268	268	268	268	268	268	234	268	268	268	261	268	178	221			
FOT MidColumbia Q3		400	400	400	400	400	400	400	400	400	400	400	400	400	400	400	400	400	400	400	400	400	400	400	400	400	
FOT MidColumbia Q3 - 2		217	375	375	375	375	375	375	375	375	375	375	375	375	375	375	375	375	375	375	375	375	375	359	367		
FOT NOB Q3		100	100	100	100	100	100	100	100	100	100	100	100	100	100	100	100	100	100	100	100	100	100	100	100	100	
Existing Plant Retirements/Conversions		(222)	-	-	57	(106)	(465)	-	(450)	-	(354)	-	-	-	(326)	-	(694)	(77)	-	(1,316)	-	-	-	-	-	-	
Annual Additions, Long Term Resources		145	161	160	166	173	441	159	248	165	617	138	149	183	860	120	536	114	515	1,601	142	-	-	-	-		
Annual Additions, Short Term Resources		717	948	993	944	1,094	1,404	1,104	1,426	1,405	1,316	1,390	1,417	1,436	1,220	1,109	1,419	1,418	1,238	1,136	1,398	-	-	-	-		
Total Annual Additions		862	1,109	1,154	1,110	1,267	1,844	1,263	1,674	1,571	1,932	1,528	1,566	1,618	2,079	1,229	1,955	1,532	1,753	2,736	1,540	-	-	-	-		

1/ Front office transaction amounts reflect one-year transaction periods, are not additive, and are reported as a 10/20-year annual average.

APPENDIX L – STOCHASTIC PRODUCTION COST SIMULATION RESULTS

Introduction

This appendix reports additional results for the Monte Carlo production cost simulations conducted with the Planning and Risk (PaR) model for the core and sensitivity cases. These results supplement the data presented in Volume I Chapter 8 of the IRP document. The results presented include the following:

- Screening of portfolios balancing costs and risk
- Statistics of the stochastic simulation results
- Components of portfolios' present value revenue requirements (PVRR)
- Energy-not-serve
- Customer rate impact of portfolios in the final screen as compares with the preferred portfolio
- Loss of load probability of the preferred portfolio

The figures and tables in this appendix are the following for the core and sensitivity cases:

- Figure L.1 through Figure L.6 – Stochastic Risk Profile under regional haze scenarios 1 and 2 by price scenario, Core Cases
- Figure L.7 – Stochastic Risk Profile under regional haze scenarios 1 and 2 and medium gas plus high CO2 price
- Table L.1 – Stochastic Mean PVRR (\$m) by Price Scenario, Core Cases
- Table L.2 – Stochastic Mean PVRR (\$m) by Price Scenario, Sensitivity Cases
- Table L.3 through Table L.6 – Stochastic Risk Results by price scenario, Core Cases
- Table L.7 through Table L.9 – Stochastic Risk Results by price scenario, Sensitivity Cases
- Table L.10 – Stochastic Risk Adjusted PVRR (\$m) by Price Scenario, Core Cases
- Table L.11 – Stochastic Risk Adjusted PVRR (\$m) by Price Scenario, Sensitivity Cases
- Table L.12 – Carbon Dioxide Emissions (Thousand Tons) by Price Scenario, Core Cases
- Table L.13 – Carbon Dioxide Emissions (Thousand Tons) by Price Scenario, Sensitivity Cases
- Table L.14 through Table L.17 – Average Annual Energy Not Served (2015 – 2034) by price scenario, Core Cases
- Table L.18 through Table L.20 – Average Annual Energy Not Served (2015 – 2034) by price scenario, Sensitivity Cases
- Table L.21 through Table L.24 – Portfolio PVRR Cost Components by price scenario, Core Cases
- Table L.25 through Table L.27 – Portfolio PVRR Cost Components by price scenario, Sensitivity Cases
- Table L.28 – 10-year Average Incremental Customer Rate Impact (\$m), Final Screen Portfolios
- Table L.29 – Loss of Load Probability for a Major (> 25,000 MWh) July Event, Final Screen Portfolios, Base Price Curve
- Table L.30 – Average Loss of Load Probability during Summer Peak, Final Screen Portfolios,

Figure L.1 – Stochastic Risk Profile under Regional Haze Scenarios 1 and 3, Low Price

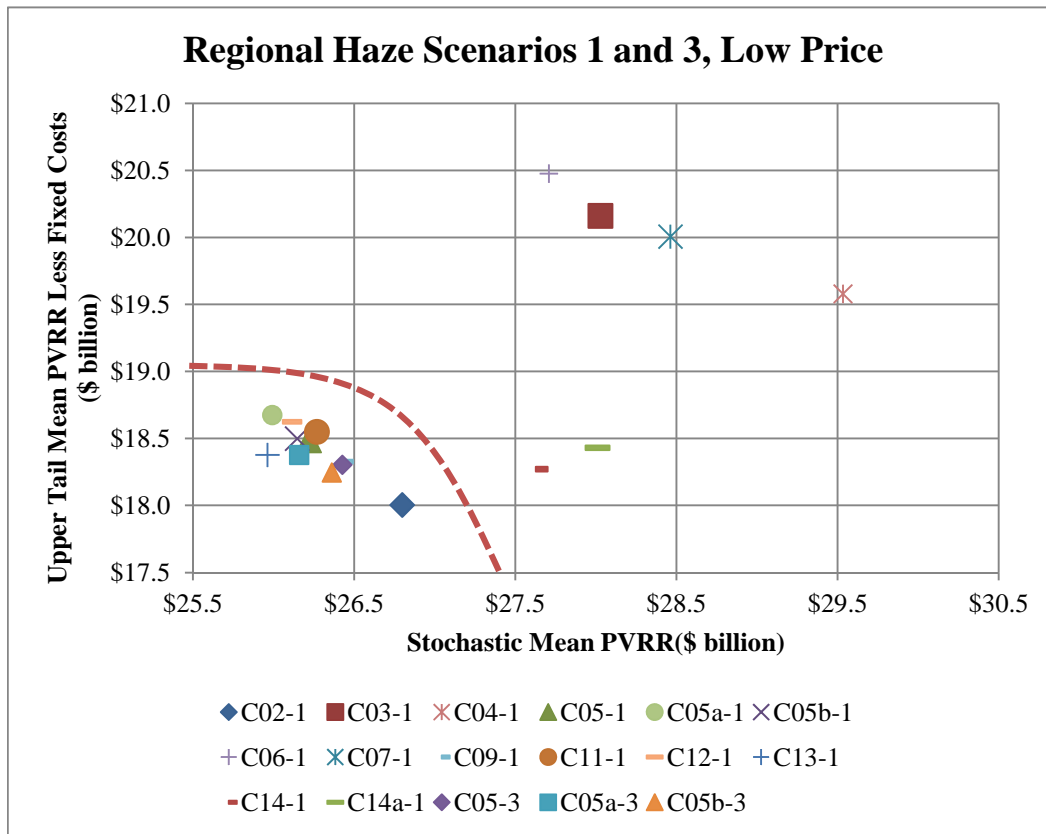

Figure L.2 – Stochastic Risk Profile under Regional Haze Scenarios 1 and 3, Base Price

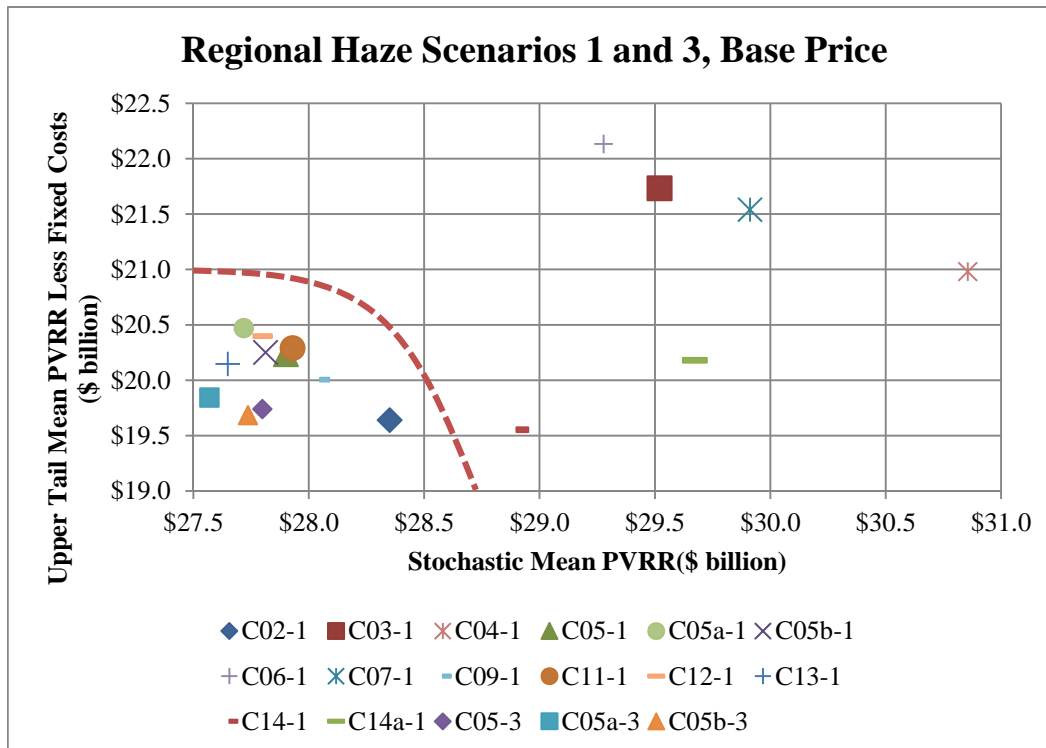

Figure L.3 – Stochastic Risk Profile under Regional Haze Scenarios 1 and 3, High Price

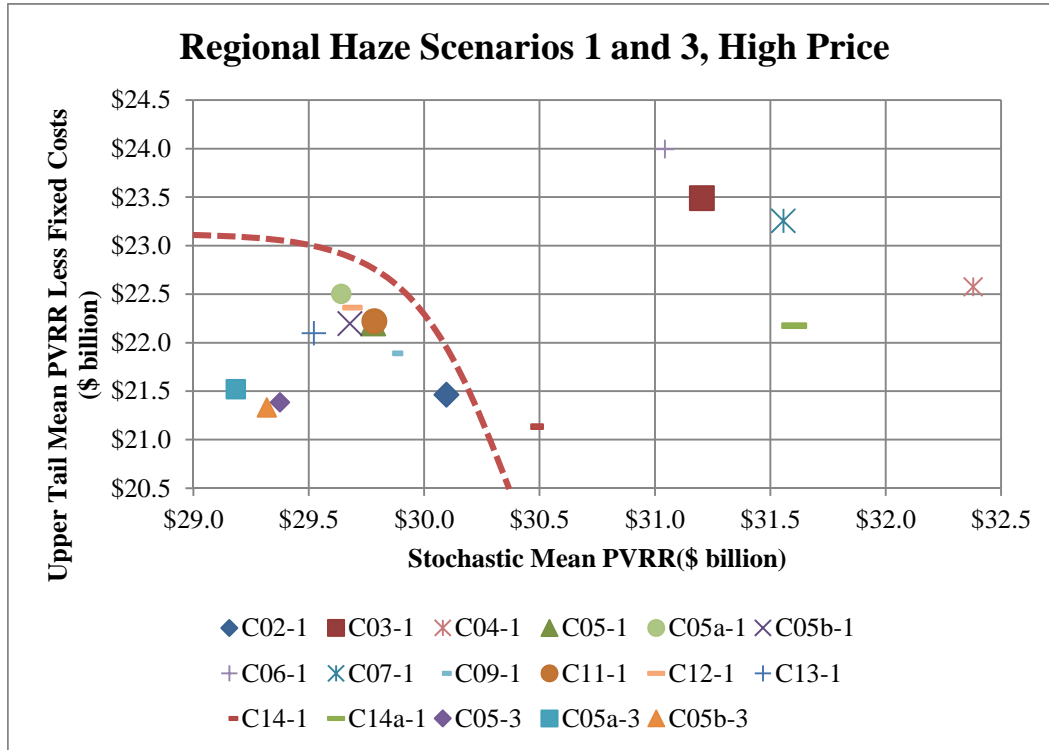

Figure L.4 – Stochastic Risk Profile under Regional Haze Scenario 2, Low Price

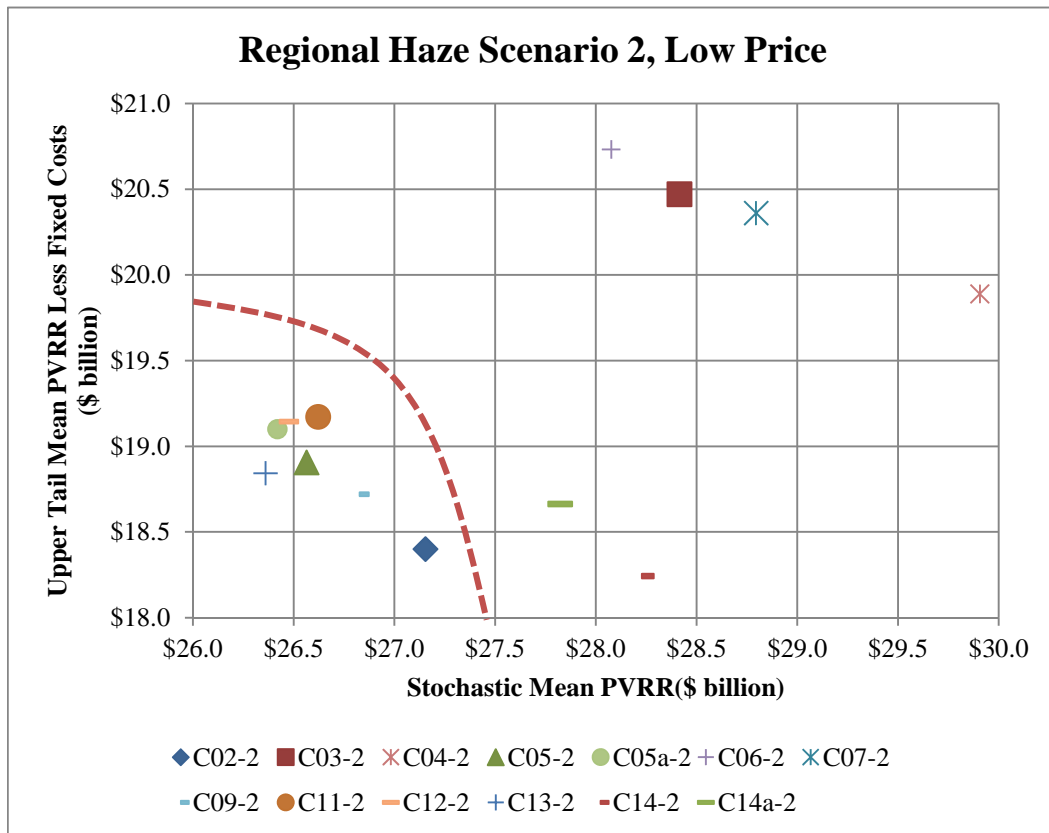

Figure L.5 – Stochastic Risk Profile under Regional Haze Scenario 2, Base Price

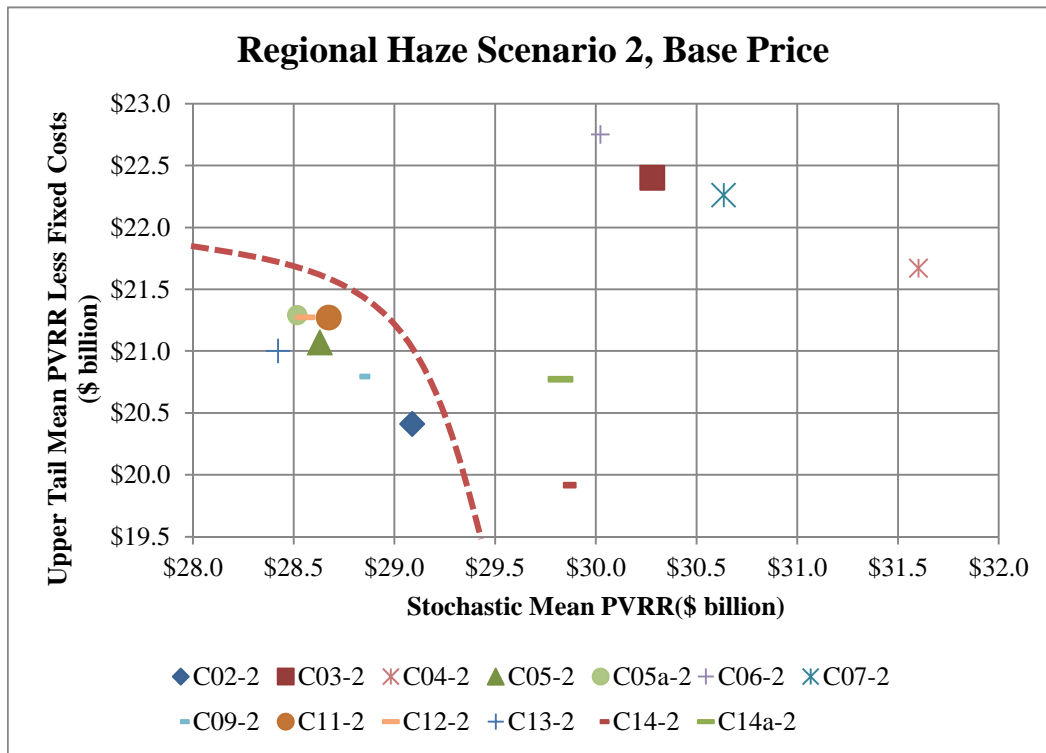

Figure L.6 – Stochastic Risk Profile under Regional Haze Scenario 2, High Price

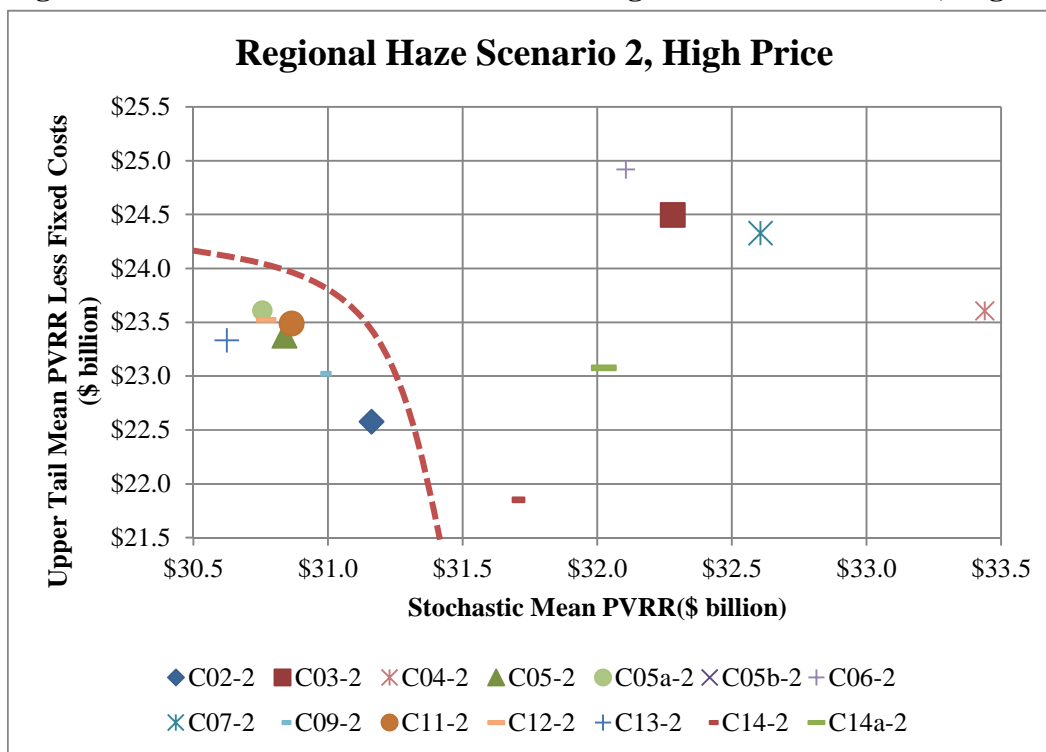

Figure L.7 – Stochastic Risk Profile, High CO₂

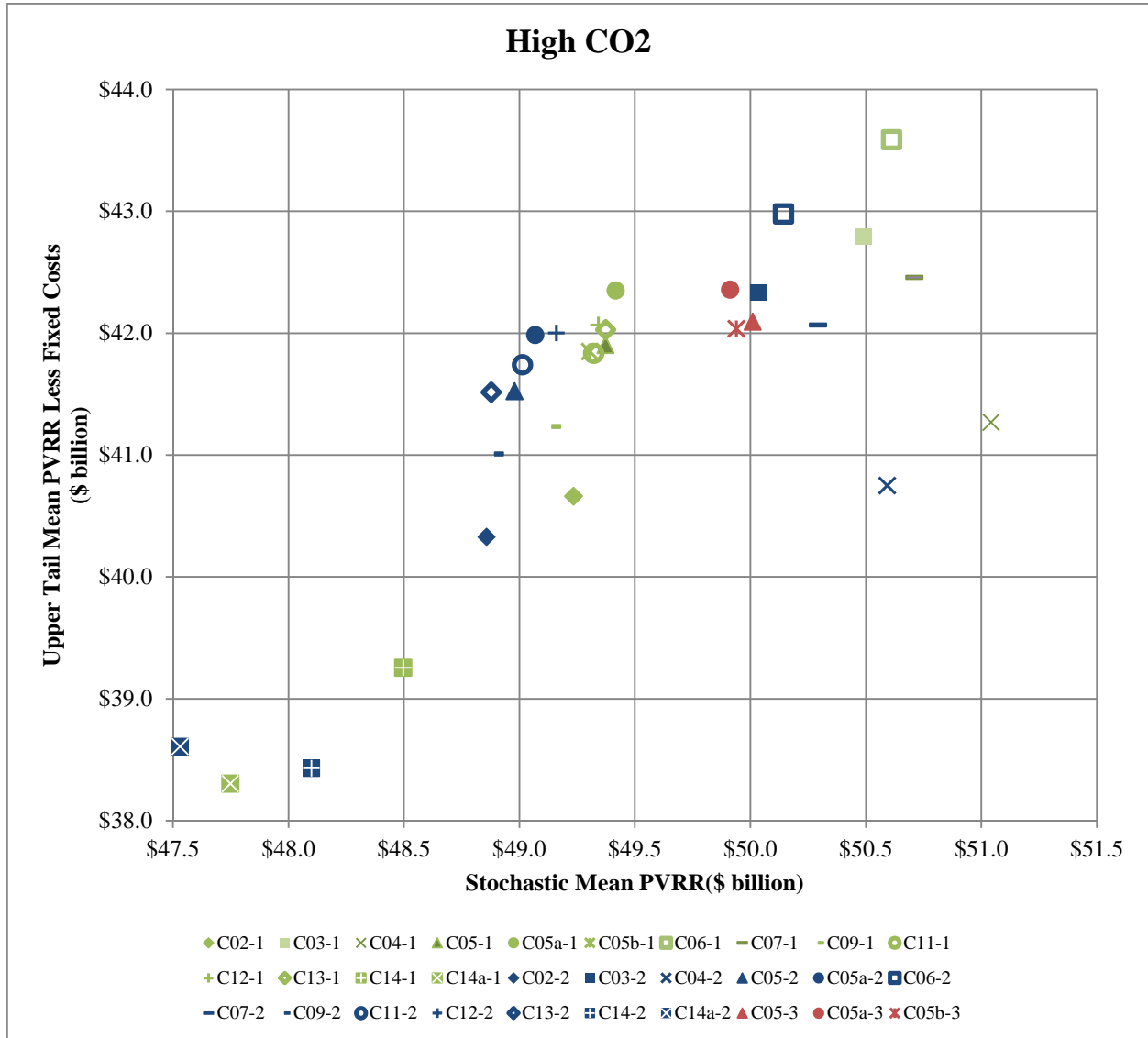

Table L.1 – Stochastic Mean PVRR (\$m) by Price Scenario, Core Cases

Case	Low	Base	High	High CO ₂
C01-R	26,888	27,990	29,347	50,810
C01-1	26,060	27,739	29,614	49,361
C02-1	26,798	28,350	30,096	49,234
C03-1	28,029	29,521	31,205	50,491
C04-1	29,534	30,856	32,379	51,042
C05-1	26,220	27,900	29,778	49,374
C05a-1	25,993	27,718	29,641	49,417
C05b-1	26,147	27,813	29,678	49,306
C06-1	27,710	29,278	31,043	50,612
C07-1	28,462	29,912	31,556	50,711
C09-1	26,435	28,049	29,865	49,142
C11-1	26,271	27,931	29,784	49,322
C12-1	26,115	27,801	29,690	49,343
C13-1	25,963	27,649	29,523	49,373
C14-1	27,627	28,900	30,464	48,497
C14a-1	28,012	29,675	31,604	47,750
C01-2	26,489	28,545	30,742	49,087
C02-2	27,154	29,088	31,161	48,858
C03-2	28,416	30,282	32,281	50,038
C04-2	29,908	31,601	33,439	50,592
C05-2	26,564	28,629	30,838	48,980
C05a-2	26,419	28,517	30,756	49,069
C06-2	28,077	30,023	32,106	50,143
C07-2	28,795	30,634	32,606	50,293
C09-2	26,827	28,831	30,976	48,895
C11-2	26,623	28,675	30,865	49,013
C12-2	26,477	28,557	30,771	49,161
C13-2	26,361	28,422	30,624	48,878
C14-2	28,229	29,841	31,686	48,100
C14a-2	27,824	29,825	32,025	47,531
C05-3	26,427	27,799	29,376	50,011
C05a-3	26,159	27,570	29,184	49,913
C05a-3Q Preferred Portfolio	26,090	27,500	29,086	49,616
C05b-3	26,361	27,736	29,319	49,940

Table L.2 – Stochastic Mean PVRR (\$m) by Price Scenario, Sensitivity Cases

Case	Low	Base	High
S-01	24,588	25,914	27,408
S-02	27,558	29,523	31,696
S-03	27,179	28,797	30,603
S-04	26,436	28,160	30,075
S-05	25,628	27,194	28,972
S-06	26,655	28,338	30,217
S-07	29,160	30,593	32,236
S-08	29,946	31,332	32,935
S-09	26,229	27,872	29,725
S-10_ECA	19,782	20,824	21,924
S-10_WCA	8,028	8,465	8,988
S-10_System	25,768	27,169	28,742
S-11	30,654	31,539	32,774
S-12	25,662	27,209	28,975
S-13	26,586	28,274	30,156
S-14	26,171	27,843	29,715
S-15	26,653	28,306	30,138

Table L.3 – Stochastic Risk Results, PVRR (\$m), Core Cases, Low Price Curve

Case	Standard Deviation	5th percentile	95th percentile	Upper Tail (mean of 3 Highest) No Fixed Costs
C01-R	176	26,609	27,190	18,157
C01-1	207	25,750	26,433	18,280
C02-1	189	26,530	27,113	18,004
C03-1	194	27,779	28,357	20,157
C04-1	190	29,271	29,845	19,579
C05-1	205	25,933	26,554	18,486
C05a-1	216	25,686	26,368	18,673
C05b-1	197	25,883	26,480	18,498
C06-1	211	27,415	28,091	20,474
C07-1	193	28,198	28,782	20,007
C09-1	171	26,182	26,684	18,326
C11-1	196	25,997	26,589	18,546
C12-1	212	25,795	26,507	18,625
C13-1	204	25,676	26,343	18,375
C14-1	220	27,355	28,039	18,268
C14a-1	223	27,708	28,394	18,428
C01-2	255	26,138	26,901	18,929
C02-2	218	26,809	27,509	18,400
C03-2	226	28,111	28,822	20,469
C04-2	228	29,557	30,258	19,887
C05-2	239	26,216	26,937	18,905
C05a-2	251	26,095	26,765	19,099
C06-2	232	27,742	28,402	20,731
C07-2	225	28,480	29,130	20,361
C09-2	218	26,507	27,183	18,720
C11-2	263	26,231	27,131	19,169
C12-2	293	26,073	27,051	19,143
C13-2	227	25,995	26,705	18,842
C14-2	198	27,967	28,592	18,241
C14a-2	222	27,516	28,165	18,661
C05-3	202	26,125	26,799	18,303
C05a-3	182	25,883	26,442	18,377
C05a-3Q Preferred Portfolio	175	25,807	26,328	18,353
C05b-3	184	26,069	26,622	18,246

Table L.4 – Stochastic Risk Results, PVRR (\$m), Core Cases, Base Price Curve

Case	Standard Deviation	5th percentile	95th percentile	Upper Tail (mean of 3 Highest) No Fixed Costs
C01-R	223	27,592	28,374	19,311
C01-1	264	27,322	28,195	20,042
C02-1	240	27,979	28,795	19,640
C03-1	244	29,181	29,964	21,731
C04-1	241	30,515	31,279	20,981
C05-1	256	27,500	28,363	20,235
C05a-1	269	27,304	28,221	20,470
C05b-1	246	27,452	28,255	20,248
C06-1	263	28,899	29,785	22,131
C07-1	243	29,563	30,350	21,539
C09-1	218	27,705	28,413	20,004
C11-1	246	27,558	28,374	20,288
C12-1	265	27,378	28,289	20,396
C13-1	260	27,258	28,096	20,145
C14-1	253	28,563	29,365	19,551
C14a-1	267	29,294	30,119	20,177
C01-2	304	28,106	29,003	21,045
C02-2	269	28,657	29,522	20,411
C03-2	273	29,893	30,762	22,399
C04-2	274	31,156	32,061	21,670
C05-2	285	28,162	29,100	21,070
C05a-2	298	28,102	28,962	21,289
C06-2	276	29,589	30,423	22,751
C07-2	273	30,226	31,024	22,262
C09-2	264	28,420	29,254	20,792
C11-2	307	28,181	29,251	21,268
C12-2	340	28,063	29,120	21,270
C13-2	279	27,966	28,864	21,001
C14-2	248	29,514	30,290	19,915
C14a-2	270	29,423	30,277	20,769
C05-3	252	27,379	28,257	19,738
C05a-3	231	27,191	27,934	19,842
C05a-3Q Preferred Portfolio	224	27,123	27,811	19,814
C05b-3	234	27,334	28,086	19,683

Table L.5 – Stochastic Risk Results, PVRR (\$m), Core Cases, High Price Curve

Case	Standard Deviation	5th percentile	95th percentile	Upper Tail (mean of 3 Highest) No Fixed Costs
C01-R	287	28,846	29,785	20,743
C01-1	329	29,088	30,113	22,034
C02-1	302	29,623	30,594	21,463
C03-1	304	30,764	31,697	23,487
C04-1	300	31,939	32,870	22,574
C05-1	317	29,277	30,333	22,197
C05a-1	333	29,129	30,218	22,499
C05b-1	306	29,230	30,213	22,195
C06-1	324	30,573	31,614	23,995
C07-1	304	31,108	32,043	23,255
C09-1	278	29,421	30,311	21,887
C11-1	309	29,312	30,273	22,218
C12-1	329	29,165	30,229	22,358
C13-1	326	29,025	30,015	22,097
C14-1	298	30,055	30,984	21,131
C14a-1	318	31,143	32,105	22,171
C01-2	363	30,216	31,346	23,336
C02-2	330	30,651	31,687	22,577
C03-2	330	31,813	32,800	24,493
C04-2	331	32,906	34,000	23,601
C05-2	341	30,279	31,371	23,375
C05a-2	356	30,241	31,339	23,608
C06-2	332	31,592	32,648	24,914
C07-2	330	32,116	33,144	24,328
C09-2	319	30,486	31,525	23,020
C11-2	362	30,285	31,493	23,486
C12-2	397	30,194	31,381	23,522
C13-2	339	30,088	31,176	23,331
C14-2	307	31,259	32,225	21,850
C14a-2	326	31,540	32,604	23,072
C05-3	313	28,857	29,885	21,385
C05a-3	292	28,693	29,649	21,520
C05a-3Q Preferred Portfolio	284	28,625	29,537	21,452
C05b-3	297	28,830	29,781	21,330

Table L.6 – Stochastic Risk Results, PVRR (\$m), Core Cases, High CO₂ Price Curve

Case	Standard Deviation	5th percentile	95th percentile	Upper Tail (mean of 3 Highest) No Fixed Costs
C01-R	263	50,336	51,179	42,258
C01-1	297	48,859	49,877	41,802
C02-1	291	48,767	49,682	40,662
C03-1	275	50,084	50,894	42,790
C04-1	266	50,600	51,421	41,267
C05-1	303	48,893	49,891	41,902
C05a-1	316	48,915	49,968	42,350
C05b-1	286	48,826	49,703	41,848
C06-1	290	50,185	51,110	43,586
C07-1	273	50,260	51,206	42,457
C09-1	259	48,708	49,533	41,233
C11-1	289	48,830	49,789	41,834
C12-1	311	48,849	49,892	42,067
C13-1	303	48,960	49,949	42,027
C14-1	327	47,997	49,045	39,253
C14a-1	324	47,344	48,296	38,303
C01-2	332	48,596	49,704	41,712
C02-2	292	48,412	49,462	40,329
C03-2	294	49,639	50,613	42,332
C04-2	290	50,144	51,054	40,750
C05-2	303	48,424	49,532	41,523
C05a-2	339	48,569	49,610	41,985
C06-2	292	49,678	50,663	42,979
C07-2	294	49,861	50,832	42,067
C09-2	295	48,478	49,459	41,008
C11-2	336	48,485	49,665	41,740
C12-2	364	48,597	49,814	42,001
C13-2	289	48,377	49,353	41,516
C14-2	311	47,652	48,634	38,429
C14a-2	329	46,958	48,044	38,608
C05-3	294	49,530	50,522	42,095
C05a-3	274	49,463	50,381	42,357
C05a-3Q Preferred Portfolio	278	49,199	50,101	42,160
C05b-3	274	49,464	50,351	42,036

Table L.7 – Stochastic Risk Results, PVRR (\$m), Sensitivity Cases, Low Price Curve

Case	Standard Deviation	5th percentile	95th percentile	Upper Tail (mean of 3 Highest) No Fixed Costs
S-01	171	24,358	24,874	17,109
S-02	197	27,278	27,854	19,342
S-03	161	26,970	27,437	18,792
S-04	199	26,144	26,768	18,581
S-05	196	25,368	25,976	18,119
S-06	229	26,335	27,129	18,695
S-07	187	28,905	29,449	19,855
S-08	198	29,689	30,325	19,837
S-09	217	25,917	26,617	18,571
S-10_ECA	272	19,456	20,276	13,809
S-10_WCA	128	7,854	8,256	5,941
S-10_System	162	25,535	25,989	17,959
S-11	181	30,375	30,969	17,116
S-12	209	25,375	26,047	18,180
S-13	204	26,294	26,907	18,567
S-14	199	25,893	26,498	18,517
S-15	206	26,347	26,976	18,649

Table L.8 – Stochastic Risk Results, PVRR (\$m), Sensitivity Cases, Base Price Curve

Case	Standard Deviation	5th percentile	95th percentile	Upper Tail (mean of 3 Highest) No Fixed Costs
S-01	220	25,589	26,338	18,517
S-02	254	29,122	29,964	21,397
S-03	211	28,481	29,131	20,460
S-04	252	27,760	28,629	20,383
S-05	248	26,846	27,680	19,768
S-06	284	27,922	28,926	20,476
S-07	237	30,249	31,008	21,370
S-08	249	30,993	31,812	21,306
S-09	267	27,467	28,355	20,279
S-10_ECA	314	20,404	21,361	14,878
S-10_WCA	141	8,258	8,707	6,394
S-10_System	211	26,834	27,466	19,418
S-11	224	31,167	31,946	18,043
S-12	261	26,824	27,721	19,797
S-13	256	27,870	28,733	20,334
S-14	252	27,451	28,312	20,273
S-15	258	27,909	28,695	20,423

Table L.9 – Stochastic Risk Results, PVRR (\$m), Sensitivity Cases, High Price Curve

Case	Standard Deviation	5th percentile	95th percentile	Upper Tail (mean of 3 Highest) No Fixed Costs
S-01	277	26,990	27,883	20,077
S-02	324	31,182	32,190	23,643
S-03	271	30,180	31,039	22,333
S-04	315	29,571	30,609	22,391
S-05	310	28,529	29,502	21,631
S-06	349	29,702	30,827	22,468
S-07	298	31,798	32,735	23,084
S-08	310	32,504	33,471	22,991
S-09	327	29,220	30,244	22,233
S-10_ECA	365	21,388	22,568	16,053
S-10_WCA	159	8,753	9,268	6,956
S-10_System	273	28,307	29,142	21,062
S-11	283	32,304	33,254	19,406
S-12	324	28,490	29,533	21,651
S-13	320	29,649	30,689	22,290
S-14	316	29,219	30,245	22,237
S-15	325	29,638	30,626	22,400

Table L.10 – Stochastic Risk Adjusted PVRR (\$m) by Price Scenario, Core Cases

Case	Low	Base	High	High CO2
C01-R	28,248	29,408	30,837	53,369
C01-1	27,382	29,149	31,120	51,855
C02-1	28,154	29,790	31,626	51,718
C03-1	29,447	31,019	32,789	53,036
C04-1	31,026	32,420	34,023	53,613
C05-1	27,547	29,319	31,295	51,869
C05a-1	27,311	29,129	31,152	51,915
C05b-1	27,471	29,226	31,189	51,791
C06-1	29,114	30,768	32,624	53,167
C07-1	29,901	31,429	33,159	53,271
C09-1	27,769	29,469	31,381	51,619
C11-1	27,601	29,350	31,298	51,811
C12-1	27,440	29,215	31,201	51,838
C13-1	27,281	29,053	31,023	51,871
C14-1	29,029	30,368	32,013	50,950
C14a-1	29,432	31,181	33,209	50,164
C01-2	27,834	29,995	32,309	51,573
C02-2	28,529	30,564	32,746	51,332
C03-2	29,857	31,820	33,921	52,569
C04-2	31,421	33,204	35,139	53,145
C05-2	27,910	30,084	32,406	51,457
C05a-2	27,757	29,966	32,323	51,550
C06-2	29,498	31,544	33,738	52,677
C07-2	30,252	32,185	34,263	52,834
C09-2	28,187	30,293	32,552	51,368
C11-2	27,980	30,138	32,440	51,496
C12-2	27,830	30,013	32,340	51,652
C13-2	27,697	29,865	32,183	51,346
C14-2	29,659	31,356	33,297	50,532
C14a-2	29,232	31,339	33,655	49,933
C05-3	27,767	29,211	30,870	52,537
C05a-3	27,481	28,967	30,667	52,432
C05a-3Q Preferred Portfolio	27,406	28,890	30,563	52,121
C05b-3	27,692	29,140	30,808	52,458

Table L.11 – Stochastic Risk Adjusted PVRR (\$m) by Price Scenario, Sensitivity Cases

Case	Low	Base	High
S-01	25,832	27,231	28,803
S-02	28,951	31,021	33,305
S-03	28,551	30,253	32,155
S-04	27,774	29,592	31,606
S-05	26,926	28,578	30,447
S-06	28,011	29,784	31,759
S-07	30,633	32,144	33,873
S-08	31,463	32,923	34,609
S-09	27,560	29,289	31,238
S-10_ECA	20,796	21,892	23,052
S-10_WCA	8,441	8,901	9,451
S-10_System	27,067	28,542	30,199
S-11	32,203	33,137	34,437
S-12	26,964	28,595	30,451
S-13	27,931	29,710	31,691
S-14	27,496	29,259	31,228
S-15	28,002	29,741	31,670

Table L.12 – Carbon Dioxide Emissions (Thousand Tons) by Price Scenario, Core Cases

Case	Low	Base	High	High CO ₂
C01-R	954,131	968,854	966,480	770,940
C01-1	884,900	891,716	887,700	749,180
C02-1	877,961	885,913	882,086	729,463
C03-1	865,727	873,288	869,936	733,376
C04-1	859,153	867,139	863,921	727,016
C05-1	882,521	889,576	885,516	736,826
C05a-1	884,354	891,521	887,442	741,484
C05b-1	885,615	892,956	889,002	739,289
C06-1	869,416	876,150	872,465	739,385
C07-1	865,338	872,280	868,916	734,375
C09-1	883,946	891,909	887,727	727,116
C11-1	881,361	888,468	883,908	734,810
C12-1	878,575	887,201	883,248	738,260
C13-1	880,500	889,921	886,142	751,840
C14-1	845,210	855,017	851,563	703,575
C14a-1	786,902	794,662	790,518	669,998
C01-2	833,847	839,679	835,188	721,516
C02-2	828,825	835,872	831,792	701,058
C03-2	819,487	825,881	821,982	701,549
C04-2	813,156	819,638	815,845	696,154
C05-2	833,961	840,153	835,753	709,547
C05a-2	836,923	843,280	838,861	713,725
C06-2	823,300	828,898	824,711	707,456
C07-2	819,570	825,263	821,324	702,313
C09-2	837,389	844,468	840,009	704,503
C11-2	832,417	838,547	833,673	709,203
C12-2	832,979	840,373	836,123	725,364
C13-2	831,714	840,321	836,068	714,659
C14-2	798,739	806,523	802,567	678,744
C14a-2	762,962	769,632	765,115	661,706
C05-3	920,425	929,133	925,789	767,434
C05a-3	920,690	929,808	926,533	766,421
C05a-3Q Preferred Portfolio	922,019	930,639	926,565	760,565
C05b-3	920,445	929,146	925,797	767,672

Table L.13 – Carbon Dioxide Emissions (Thousand Tons) by Price Scenario, Sensitivity Cases

Case	Low	Base	High
S-01	854,947	862,891	860,285
S-02	906,398	913,399	908,198
S-03	883,328	891,064	886,684
S-04	886,590	893,822	889,722
S-05	872,672	879,615	875,786
S-06	879,179	885,555	881,575
S-07	867,801	875,603	872,134
S-08	865,604	873,525	870,110
S-09	875,527	882,938	878,961
S-10_ECA	664,332	671,039	667,937
S-10_WCA	235,827	240,945	242,142
S-10_System	923,536	928,931	924,459
S-11	815,094	827,344	824,962
S-12	873,102	879,784	875,867
S-13	878,753	885,215	881,317
S-14	880,406	887,152	883,024
S-15	869,631	876,787	873,126

Table L.14 – Average Annual Energy Not Served (2015 – 2034), Core Cases, Low Price Curve

Case	Average Annual Energy Not Served, 2015-2034 (GWh)	Upper Tail Mean Energy Not Served Cumulative Total, 2015-2034 (GWh)
C01-R	59.2	79.5
C01-1	41.4	53.1
C02-1	57.1	79.4
C03-1	60.6	81.0
C04-1	60.0	80.6
C05-1	59.7	84.6
C05a-1	61.5	83.0
C05b-1	59.6	81.2
C06-1	62.4	85.3
C07-1	59.9	81.4
C09-1	55.3	78.4
C11-1	58.2	80.7
C12-1	64.2	84.9
C13-1	42.0	53.3
C14-1	76.1	55.0
C14a-1	76.0	98.8
C01-2	72.5	99.6
C02-2	80.5	113.9
C03-2	76.5	105.2
C04-2	78.3	103.7
C05-2	83.0	128.5
C05a-2	85.6	128.0
C06-2	78.5	109.2
C07-2	78.5	107.5
C09-2	73.6	107.3
C11-2	84.2	135.3
C12-2	84.3	127.3
C13-2	71.8	98.6
C14-2	78.6	96.0
C14a-2	75.0	96.7
C05-3	64.2	83.6
C05a-3	61.1	79.5
C05a-3Q Preferred Portfolio	58.9	80.2
C05b-3	62.8	80.4

Table L.15 – Average Annual Energy Not Served (2015 – 2034), Core Cases, Base Price Curve

Case	Average Annual Energy Not Served, 2015-2034 (GWh)	Upper Tail Mean Energy Not Served Cumulative Total, 2015-2034 (GWh)
C01-R	60.2	80.0
C01-1	42.2	53.3
C02-1	58.0	79.7
C03-1	61.7	81.2
C04-1	61.0	80.7
C05-1	60.6	84.9
C05a-1	62.5	83.2
C05b-1	60.5	81.4
C06-1	63.6	85.4
C07-1	60.9	81.5
C09-1	55.9	78.6
C11-1	58.9	80.9
C12-1	65.2	85.4
C13-1	43.0	53.5
C14-1	76.7	54.3
C14a-1	77.0	99.3
C01-2	73.2	100.0
C02-2	81.4	114.2
C03-2	77.7	105.4
C04-2	79.4	103.9
C05-2	84.0	128.7
C05a-2	86.5	128.5
C06-2	79.9	109.6
C07-2	79.6	107.8
C09-2	74.1	107.6
C11-2	85.0	135.8
C12-2	85.7	127.6
C13-2	72.5	99.2
C14-2	79.8	96.2
C14a-2	75.7	96.9
C05-3	65.3	84.3
C05a-3	62.3	79.8
C05a-3Q Preferred Portfolio	59.8	80.5
C05b-3	64.0	80.7

Table L.16 – Average Annual Energy Not Served (2015 – 2034), Core Cases, High Price Curve

Case	Average Annual Energy Not Served, 2015-2034 (GWh)	Upper Tail Mean Energy Not Served Cumulative Total, 2015-2034 (GWh)
C01-R	61.5	80.8
C01-1	43.5	53.8
C02-1	59.4	80.5
C03-1	63.3	82.1
C04-1	62.6	81.6
C05-1	62.2	85.8
C05a-1	64.2	84.0
C05b-1	62.2	82.2
C06-1	65.2	86.4
C07-1	62.6	82.4
C09-1	57.3	79.5
C11-1	60.3	81.6
C12-1	66.8	86.0
C13-1	44.3	54.2
C14-1	78.3	55.8
C14a-1	78.7	100.4
C01-2	74.7	100.5
C02-2	83.0	115.4
C03-2	79.4	106.3
C04-2	81.1	104.8
C05-2	85.7	129.9
C05a-2	88.3	129.6
C06-2	81.5	110.5
C07-2	81.3	108.9
C09-2	75.5	108.6
C11-2	86.7	136.7
C12-2	87.6	128.6
C13-2	74.0	100.1
C14-2	81.2	97.1
C14a-2	77.5	97.6
C05-3	66.8	85.3
C05a-3	63.7	80.7
C05a-3Q Preferred Portfolio	61.1	81.4
C05b-3	65.4	81.5

Table L.17 – Average Annual Energy Not Served (2015 – 2034), Core Cases, High CO₂ Price Curve

Case	Average Annual Energy Not Served, 2015-2034 (GWh)	Upper Tail Mean Energy Not Served Cumulative Total, 2015-2034 (GWh)
C01-R	61.9	79.4
C01-1	50.2	58.2
C02-1	61.0	83.3
C03-1	67.6	83.0
C04-1	68.1	83.5
C05-1	63.9	89.0
C05a-1	66.3	86.0
C05b-1	63.4	82.6
C06-1	69.0	87.7
C07-1	67.2	84.6
C09-1	57.7	80.0
C11-1	62.0	82.6
C12-1	72.3	88.7
C13-1	53.1	56.9
C14-1	97.9	61.5
C14a-1	99.7	121.0
C01-2	97.2	117.9
C02-2	101.4	132.5
C03-2	99.0	122.4
C04-2	100.7	122.1
C05-2	103.9	145.8
C05a-2	106.7	146.0
C06-2	100.4	127.9
C07-2	100.7	124.7
C09-2	94.3	125.3
C11-2	104.8	154.4
C12-2	111.4	144.9
C13-2	95.5	116.2
C14-2	93.9	111.7
C14a-2	94.1	113.8
C05-3	68.2	86.0
C05a-3	64.2	79.3
C05a-3Q		
Preferred Portfolio	60.8	80.1
C05b-3	66.8	80.3

Table L.18 – Average Annual Energy Not Served (2015 – 2034), Sensitivity Cases, Low Price Curve

Case	Average Annual Energy Not Served, 2015-2034 (GWh)	Upper Tail Mean Energy Not Served Cumulative Total, 2015-2034
S-01	43.1	61.6
S-02	56.5	73.6
S-03	27.3	46.9
S-04	61.3	83.6
S-05	51.9	72.4
S-06	66.5	83.5
S-07	57.3	81.0
S-08	58.5	82.0
S-09	74.5	96.7
S-10_ECA	50.3	54.8
S-10_WCA	17.4	46.3
S-10_System	32.8	56.7
S-11	66.8	89.5
S-12	54.7	73.1
S-13	61.3	81.7
S-14	60.7	81.6
S-15	55.9	74.5

Table L.19 – Average Annual Energy Not Served (2015 – 2034), Sensitivity Cases, Base Price Curve

Case	Average Annual Energy Not Served, 2015-2034 (GWh)	Upper Tail Mean Energy Not Served Cumulative Total, 2015-2034
S-01	43.9	61.8
S-02	57.2	73.9
S-03	27.4	46.9
S-04	62.1	83.8
S-05	52.8	72.4
S-06	67.8	83.9
S-07	58.3	81.1
S-08	59.5	82.1
S-09	75.6	97.1
S-10_ECA	51.2	54.8
S-10_WCA	17.1	46.1
S-10_System	33.4	57.1
S-11	67.3	90.1
S-12	55.8	73.3
S-13	62.2	82.0
S-14	61.6	82.0
S-15	56.3	74.2

Table L.20 – Average Annual Energy Not Served (2015 – 2034), Sensitivity Cases, Price Curve

Case	Average Annual Energy Not Served, 2015-2034 (GWh)	Upper Tail Mean Energy Not Served Cumulative Total, 2015-2034
S-01	45.2	62.3
S-02	58.8	74.5
S-03	28.4	47.4
S-04	63.8	84.8
S-05	54.3	73.4
S-06	69.7	84.5
S-07	59.8	81.8
S-08	60.8	82.8
S-09	77.3	98.1
S-10_ECA	52.3	54.8
S-10_WCA	17.4	46.3
S-10_System	34.2	57.4
S-11	68.5	91.0
S-12	57.3	74.1
S-13	63.7	82.8
S-14	63.1	82.8
S-15	57.3	74.5

Table L.21 – Portfolio PVRR (\$m) Cost Components, Core Cases, Low Price Curve

Case	Thermal Fuel	Variable O&M incl. FOT	Emission Cost	Long Term Contracts	Renewables	DSM	System Balancing Sales	System Balancing Purchases	Capital and Fixed O&M Cost	Total PVRR
C01-R	13,671	1,487	0	908	1,901	800	(3,190)	2,202	9,109	26,888
C01-1	13,419	1,598	0	910	1,904	737	(2,943)	2,241	8,193	26,060
C02-1	13,251	1,480	0	911	1,927	728	(3,016)	2,314	9,205	26,798
C03-1	12,902	1,424	0	909	1,910	3,003	(2,910)	2,484	8,306	28,029
C04-1	12,775	1,283	0	909	1,976	3,003	(3,046)	2,244	10,391	29,534
C05-1	13,320	1,595	0	911	1,904	728	(2,894)	2,472	8,184	26,220
C05a-1	13,369	1,633	0	912	1,897	731	(2,867)	2,529	7,789	25,993
C05b-1	13,368	1,600	0	912	1,907	728	(2,938)	2,459	8,111	26,147
C06-1	12,954	1,499	0	910	1,902	3,008	(2,857)	2,582	7,713	27,710
C07-1	12,868	1,389	0	909	1,920	3,004	(2,952)	2,428	8,897	28,462
C09-1	13,399	1,414	0	912	1,905	949	(2,943)	2,330	8,469	26,436
C11-1	13,266	1,553	0	914	1,903	907	(2,894)	2,471	8,151	26,271
C12-1	13,299	1,610	0	911	1,910	763	(2,867)	2,532	7,955	26,115
C13-1	13,400	1,586	0	910	1,904	789	(2,911)	2,273	8,012	25,963
C14-1	12,559	1,617	0	910	1,935	1,120	(2,920)	2,502	9,904	27,627
C14a-1	12,470	1,728	0	914	1,943	1,155	(2,902)	2,587	10,118	28,012
C01-2	13,318	1,641	0	911	1,903	847	(2,878)	2,639	8,108	26,489
C02-2	13,267	1,546	0	910	1,930	777	(2,976)	2,515	9,184	27,154
C03-2	12,944	1,493	0	909	1,911	3,002	(2,899)	2,638	8,417	28,416
C04-2	12,810	1,350	0	909	1,976	2,994	(3,034)	2,425	10,478	29,908
C05-2	13,368	1,665	0	910	1,911	777	(2,872)	2,660	8,143	26,564
C05a-2	13,422	1,683	0	912	1,898	780	(2,859)	2,711	7,872	26,419
C06-2	13,010	1,570	0	910	1,903	3,003	(2,846)	2,729	7,800	28,077
C07-2	12,923	1,469	0	909	1,916	3,004	(2,925)	2,611	8,888	28,795
C09-2	13,464	1,477	0	913	1,905	944	(2,927)	2,500	8,552	26,828
C11-2	13,300	1,643	0	913	1,911	934	(2,863)	2,701	8,084	26,623
C12-2	13,388	1,694	0	911	1,911	774	(2,873)	2,669	8,003	26,478
C13-2	13,380	1,670	0	912	1,911	798	(2,869)	2,590	7,969	26,362
C14-2	12,534	1,632	0	910	1,958	1,152	(2,929)	2,546	10,426	28,229
C14a-2	12,676	1,764	0	914	1,931	1,163	(2,865)	2,623	9,618	27,824
C05-3	13,475	1,492	0	908	1,911	773	(3,010)	2,320	8,557	26,427
C05a-3	13,490	1,519	0	908	1,898	787	(2,953)	2,340	8,171	26,159
C05a-3Q Preferred Portfolio	13,525	1,463	0	903	1,938	764	(2,944)	2,327	8,115	26,090
C05b-3	13,472	1,492	0	908	1,909	774	(3,007)	2,318	8,495	26,361

Table L.22 – Portfolio PVRR (\$m) Cost Components, Core Cases, Base Price Curve

Case	Thermal Fuel	Variable O&M incl. FOT	Emission Cost	Long Term Contracts	Renewable	DSM	System Balancing Sales	System Balancing Purchases	Capital and Fixed O&M Cost	Total PVRR
C01-R	15,171	1,616	0	912	1,901	800	(4,138)	2,618	9,109	27,990
C01-1	15,211	1,743	0	914	1,904	737	(3,760)	2,796	8,193	27,739
C02-1	14,998	1,605	0	916	1,927	728	(3,861)	2,833	9,205	28,350
C03-1	14,503	1,554	0	913	1,910	3,003	(3,727)	3,059	8,306	29,521
C04-1	14,348	1,389	0	912	1,975	3,003	(3,902)	2,739	10,391	30,856
C05-1	15,082	1,744	0	916	1,904	728	(3,705)	3,049	8,184	27,900
C05a-1	15,147	1,788	0	917	1,897	731	(3,670)	3,119	7,789	27,718
C05b-1	15,136	1,750	0	917	1,907	728	(3,760)	3,024	8,111	27,813
C06-1	14,563	1,644	0	913	1,902	3,008	(3,656)	3,191	7,713	29,278
C07-1	14,452	1,514	0	912	1,920	3,004	(3,775)	2,987	8,897	29,912
C09-1	15,194	1,522	0	919	1,905	949	(3,777)	2,868	8,469	28,049
C11-1	15,017	1,697	0	920	1,903	906	(3,706)	3,043	8,151	27,932
C12-1	15,075	1,762	0	916	1,910	763	(3,686)	3,105	7,955	27,801
C13-1	15,217	1,736	0	914	1,904	789	(3,745)	2,823	8,012	27,649
C14-1	14,022	1,754	0	915	1,936	1,120	(3,757)	3,007	9,904	28,900
C14a-1	14,234	1,866	0	921	1,943	1,155	(3,715)	3,153	10,118	29,675
C01-2	15,382	1,796	0	916	1,903	847	(3,672)	3,265	8,108	28,545
C02-2	15,341	1,674	0	915	1,930	777	(3,808)	3,074	9,184	29,088
C03-2	14,861	1,619	0	913	1,911	3,002	(3,705)	3,263	8,417	30,282
C04-2	14,685	1,452	0	912	1,976	2,994	(3,872)	2,976	10,478	31,601
C05-2	15,470	1,817	0	915	1,911	777	(3,673)	3,269	8,143	28,629
C05a-2	15,543	1,838	0	917	1,898	780	(3,656)	3,326	7,872	28,518
C06-2	14,940	1,710	0	913	1,903	3,003	(3,633)	3,387	7,800	30,023
C07-2	14,826	1,590	0	912	1,916	3,004	(3,732)	3,229	8,888	30,634
C09-2	15,609	1,588	0	919	1,906	944	(3,753)	3,067	8,552	28,831
C11-2	15,384	1,791	0	919	1,911	933	(3,661)	3,313	8,084	28,676
C12-2	15,509	1,851	0	916	1,911	774	(3,681)	3,274	8,003	28,557
C13-2	15,519	1,818	0	918	1,912	798	(3,693)	3,182	7,969	28,422
C14-2	14,270	1,768	0	915	1,958	1,152	(3,754)	3,107	10,426	29,841
C14a-2	14,727	1,903	0	921	1,931	1,163	(3,666)	3,229	9,618	29,826
C05-3	15,075	1,619	0	912	1,911	773	(3,861)	2,812	8,557	27,799
C05a-3	15,099	1,651	0	912	1,898	787	(3,794)	2,847	8,171	27,571
C05a-3Q Preferred Portfolio	15,129	1,586	0	904	2,010	764	(3,804)	2,797	8,115	27,500
C05b-3	15,071	1,620	0	912	1,909	774	(3,855)	2,810	8,495	27,736

Table L.23 – Portfolio PVRR (\$m) Cost Components, Core Cases, High Price Curve

Case	Thermal Fuel	Variable O&M incl. FOT	Emission Cost	Long Term Contracts	Renewable	DSM	System Balancing Sales	System Balancing Purchases	Capital and Fixed O&M Cost	Total PVRR
C01-R	16,484	1,737	0	911	1,901	800	(4,965)	3,369	9,109	29,348
C01-1	16,797	1,885	0	914	1,904	737	(4,481)	3,665	8,193	29,614
C02-1	16,528	1,726	0	916	1,927	728	(4,605)	3,672	9,205	30,096
C03-1	15,929	1,671	0	913	1,910	3,003	(4,453)	3,925	8,306	31,205
C04-1	15,752	1,482	0	912	1,975	3,003	(4,667)	3,531	10,391	32,379
C05-1	16,630	1,886	0	916	1,904	728	(4,415)	3,946	8,184	29,778
C05a-1	16,710	1,937	0	917	1,897	731	(4,371)	4,032	7,789	29,641
C05b-1	16,691	1,894	0	917	1,907	728	(4,482)	3,913	8,111	29,678
C06-1	16,000	1,775	0	913	1,902	3,008	(4,361)	4,094	7,713	31,043
C07-1	15,872	1,626	0	912	1,920	3,004	(4,511)	3,836	8,897	31,556
C09-1	16,759	1,624	0	919	1,905	949	(4,502)	3,741	8,469	29,866
C11-1	16,512	1,831	0	920	1,903	905	(4,403)	3,966	8,151	29,784
C12-1	16,618	1,908	0	916	1,910	763	(4,391)	4,010	7,955	29,690
C13-1	16,795	1,876	0	914	1,903	789	(4,463)	3,696	8,012	29,523
C14-1	15,332	1,881	0	915	1,935	1,120	(4,481)	3,857	9,904	30,464
C14a-1	15,823	1,993	0	921	1,942	1,155	(4,419)	4,070	10,118	31,604
C01-2	17,176	1,941	0	916	1,903	847	(4,364)	4,215	8,108	30,742
C02-2	17,147	1,799	0	915	1,930	777	(4,538)	3,947	9,184	31,161
C03-2	16,540	1,737	0	913	1,911	3,002	(4,417)	4,179	8,417	32,281
C04-2	16,334	1,544	0	912	1,976	2,994	(4,622)	3,822	10,478	33,439
C05-2	17,303	1,962	0	915	1,911	777	(4,371)	4,197	8,143	30,838
C05a-2	17,387	1,986	0	917	1,898	780	(4,349)	4,264	7,872	30,756
C06-2	16,636	1,841	0	913	1,903	3,003	(4,326)	4,336	7,800	32,106
C07-2	16,499	1,703	0	912	1,916	3,004	(4,450)	4,132	8,888	32,606
C09-2	17,464	1,693	0	919	1,905	944	(4,470)	3,967	8,552	30,976
C11-2	17,160	1,932	0	920	1,911	932	(4,344)	4,271	8,084	30,865
C12-2	17,344	1,999	0	916	1,911	774	(4,379)	4,203	8,003	30,771
C13-2	17,347	1,960	0	918	1,911	798	(4,393)	4,113	7,969	30,624
C14-2	15,820	1,893	0	915	1,958	1,152	(4,474)	3,997	10,426	31,686
C14a-2	16,539	2,034	0	921	1,931	1,163	(4,356)	4,176	9,618	32,025
C05-3	16,481	1,740	0	912	1,911	773	(4,612)	3,614	8,557	29,376
C05a-3	16,510	1,776	0	912	1,898	787	(4,532)	3,663	8,171	29,184
C05a-3Q Preferred Portfolio	16,507	1,698	0	909	2,113	764	(4,579)	3,559	8,115	29,086
C05b-3	16,477	1,743	0	912	1,909	774	(4,606)	3,616	8,495	29,319

Table L.24 – Portfolio PVRR (\$m) Cost Components, Core Cases, High CO₂ Price Curve

Case	Thermal Fuel	Variable O&M incl. FOT	Emission Cost	Long Term Contracts	Renewable	DSM	System Balancing Sales	System Balancing Purchases	Capital and Fixed O&M Cost	Total PVRR
C01-R	15,444	2,118	16,568	923	1,901	800	(4,008)	7,953	9,109	50,810
C01-1	16,274	2,333	15,826	924	1,904	737	(4,159)	7,328	8,193	49,361
C02-1	15,983	2,108	15,095	924	1,927	728	(4,216)	7,481	9,205	49,234
C03-1	15,236	2,046	15,285	923	1,911	3,003	(4,051)	7,832	8,306	50,491
C04-1	15,079	1,752	15,027	923	1,976	3,003	(4,324)	7,215	10,391	51,042
C05-1	16,100	2,343	15,324	924	1,905	728	(3,997)	7,864	8,184	49,374
C05a-1	16,183	2,418	15,497	925	1,898	731	(3,959)	7,935	7,789	49,417
C05b-1	16,148	2,346	15,395	925	1,907	728	(4,034)	7,780	8,111	49,306
C06-1	15,331	2,199	15,462	924	1,902	3,008	(3,957)	8,030	7,713	50,612
C07-1	15,214	1,973	15,304	923	1,920	3,004	(4,158)	7,634	8,897	50,711
C09-1	16,320	1,968	14,978	925	1,905	949	(4,087)	7,714	8,469	49,142
C11-1	16,013	2,274	15,273	926	1,904	910	(4,002)	7,872	8,151	49,322
C12-1	16,060	2,382	15,431	924	1,911	763	(3,972)	7,890	7,955	49,343
C13-1	16,215	2,333	15,992	924	1,904	789	(4,121)	7,325	8,012	49,373
C14-1	14,656	2,265	13,942	924	1,936	1,120	(4,086)	7,836	9,904	48,497
C14a-1	15,354	2,361	12,787	925	1,943	1,155	(4,218)	7,325	10,118	47,750
C01-2	16,684	2,405	14,765	925	1,904	847	(4,144)	7,596	8,108	49,088
C02-2	16,610	2,191	14,011	924	1,931	777	(4,256)	7,487	9,184	48,858
C03-2	15,941	2,120	14,038	923	1,911	3,002	(4,119)	7,804	8,417	50,038
C04-2	15,772	1,824	13,820	923	1,977	2,994	(4,399)	7,205	10,478	50,592
C05-2	16,781	2,428	14,277	924	1,912	777	(4,068)	7,807	8,143	48,980
C05a-2	16,858	2,461	14,426	925	1,899	780	(4,043)	7,892	7,872	49,070
C06-2	16,052	2,273	14,213	924	1,903	3,003	(4,022)	7,998	7,800	50,143
C07-2	15,930	2,071	14,048	923	1,917	3,004	(4,191)	7,702	8,888	50,293
C09-2	17,023	2,041	14,108	925	1,906	944	(4,184)	7,580	8,552	48,895
C11-2	16,663	2,397	14,292	926	1,911	935	(4,058)	7,863	8,084	49,013
C12-2	16,891	2,486	14,942	924	1,912	774	(4,194)	7,424	8,003	49,161
C13-2	16,858	2,436	14,554	924	1,912	798	(4,117)	7,544	7,969	48,878
C14-2	15,309	2,266	12,999	924	1,958	1,152	(4,235)	7,302	10,426	48,100
C14a-2	16,027	2,416	12,470	925	1,931	1,163	(4,226)	7,207	9,618	47,531
C05-3	15,769	2,151	16,368	923	1,911	773	(4,138)	7,696	8,557	50,011
C05a-3	15,790	2,206	16,335	923	1,898	787	(4,036)	7,840	8,171	49,913
C05a-3Q Preferred Portfolio	15,750	2,099	16,121	919	2,175	764	(4,071)	7,743	8,115	49,616
C05b-3	15,771	2,152	16,374	923	1,909	774	(4,134)	7,676	8,495	49,940

Table L.25 – Portfolio PVRR (\$m) Cost Components, Sensitivity Cases, Low Price Curve

Case	Thermal Fuel	Variable O&M incl. FOT	Long Term Contracts	Renewable	DSM	System Balancing Sales	System Balancing Purchases	Transmission Capital and O&M	Capital and Fixed O&M Cost	Total PVRR
S-01	12,648	1,429	905	1,904	758	(2,998)	2,079	0	7,864	24,588
S-02	13,961	1,686	919	1,905	789	(2,846)	2,535	0	8,609	27,558
S03	13,373	1,724	907	1,957	1,576	(3,054)	1,947	0	8,749	27,179
S-04	13,441	1,610	910	1,904	738	(2,904)	2,454	0	8,282	26,436
S-05	13,054	1,556	910	1,904	735	(2,902)	2,430	0	7,942	25,628
S-06	13,200	1,575	915	1,911	786	(2,863)	2,652	0	8,479	26,655
S-07	12,915	1,438	908	1,946	2,830	(2,935)	2,331	945	8,782	29,160
S-08	12,823	1,449	909	1,967	2,826	(2,943)	2,329	2,044	8,543	29,946
S-09	13,192	1,618	909	1,931	742	(2,878)	2,584	0	8,130	26,229
S-10_ECA	9,930	703	348	1,726	1,245	(2,073)	1,368	0	6,536	19,782
S-10_WCA	3,198	766	574	304	199	(635)	1,268	0	2,352	8,027
S-10_System	13,461	1,459	901	1,938	768	(2,973)	2,110	0	8,106	25,768
S-11	12,055	1,499	909	1,990	1,280	(3,044)	2,048	0	13,917	30,654
S-12	13,055	1,559	911	1,912	772	(2,946)	2,442	0	7,956	25,662
S-13	13,203	1,587	915	1,904	766	(2,846)	2,604	0	8,452	26,586
S-14	13,252	1,600	911	1,906	786	(2,887)	2,527	0	8,076	26,172
S-15	12,903	1,595	912	1,904	989	(2,762)	2,717	0	8,397	26,654

Table L.26 – Portfolio PVRR (\$m) Cost Components, Sensitivity Cases, Base Price Curve

Case	Thermal Fuel	Variable O&M incl. FOT	Long Term Contracts	Renewable	DSM	System Balancing Sales	System Balancing Purchases	Transmission Capital and O&M	Capital and Fixed O&M Cost	Total PVRR
S-01	14,196	1,561	908	1,904	758	(3,850)	2,574	0	7,864	25,914
S-02	15,965	1,840	929	1,905	789	(3,642)	3,128	0	8,609	29,523
S03	15,157	1,899	912	1,957	1,576	(3,903)	2,449	0	8,749	28,797
S-04	15,257	1,759	916	1,904	738	(3,718)	3,021	0	8,282	28,160
S-05	14,701	1,705	914	1,904	735	(3,714)	3,008	0	7,942	27,194
S-06	14,901	1,725	919	1,911	786	(3,656)	3,273	0	8,479	28,338
S-07	14,528	1,564	912	1,946	2,830	(3,767)	2,853	945	8,782	30,593
S-08	14,395	1,583	912	1,967	2,826	(3,777)	2,839	2,044	8,543	31,332
S-09	14,914	1,774	914	1,931	742	(3,689)	3,155	0	8,130	27,872
S-10_ECA	11,282	733	352	1,796	1,245	(2,725)	1,604	0	6,536	20,824
S-10_WCA	3,426	916	574	304	199	(791)	1,484	0	2,352	8,465
S-10_System	14,993	1,579	901	2,010	768	(3,794)	2,606	0	8,106	27,169
S-11	13,403	1,596	914	1,990	1,280	(3,944)	2,382	0	13,917	31,539
S-12	14,695	1,705	915	1,912	772	(3,759)	3,014	0	7,956	27,209
S-13	14,908	1,739	921	1,904	766	(3,639)	3,223	0	8,452	28,274
S-14	14,977	1,750	916	1,906	786	(3,691)	3,122	0	8,076	27,844
S-15	14,511	1,758	917	1,904	989	(3,543)	3,373	0	8,397	28,307

Table L.27 – Portfolio PVRR (\$m) Cost Components, Sensitivity Cases, High Price Curve

Case	Thermal Fuel	Variable O&M incl. FOT	Long Term Contracts	Renewable	DSM	System Balancing Sales	System Balancing Purchases	Transmission Capital and O&M	Capital and Fixed O&M Cost	Total PVRR
S-01	15,572	1,683	908	1,903	758	(4,615)	3,335	0	7,864	27,408
S-02	17,686	1,986	929	1,905	789	(4,314)	4,106	0	8,609	31,696
S03	16,701	2,062	917	1,958	1,576	(4,642)	3,283	0	8,749	30,603
S-04	16,849	1,903	916	1,904	738	(4,430)	3,913	0	8,282	30,075
S-05	16,165	1,846	914	1,904	735	(4,428)	3,894	0	7,942	28,972
S-06	16,410	1,867	919	1,911	786	(4,356)	4,201	0	8,479	30,217
S-07	15,959	1,683	912	1,946	2,830	(4,501)	3,681	945	8,782	32,236
S-08	15,792	1,707	912	1,967	2,826	(4,514)	3,658	2,044	8,543	32,935
S-09	16,431	1,923	914	1,931	742	(4,396)	4,050	0	8,130	29,725
S-10_ECA	12,495	742	356	1,903	1,245	(3,296)	1,943	0	6,536	21,924
S-10_WCA	3,548	1,054	574	304	199	(913)	1,869	0	2,352	8,987
S-10_System	16,325	1,689	906	2,114	768	(4,562)	3,397	0	8,106	28,742
S-11	14,620	1,679	914	1,990	1,280	(4,722)	3,095	0	13,917	32,774
S-12	16,155	1,846	915	1,912	772	(4,481)	3,900	0	7,956	28,975
S-13	16,418	1,883	924	1,904	766	(4,337)	4,146	0	8,452	30,156
S-14	16,497	1,894	917	1,906	786	(4,394)	4,034	0	8,076	29,716
S-15	15,922	1,917	917	1,904	989	(4,223)	4,316	0	8,397	30,139

Table L.28 –10-year Average Incremental Customer Rate Impact (\$m), Final Screen Portfolios

Case	Low Price		Base Price		High Price		Average	
	Difference from Preferred Portfolio	Rank	Difference from Preferred Portfolio	Rank	Difference from Preferred Portfolio	Rank	Difference from Preferred Portfolio	Rank
C05a-3Q, Preferred Portfolio	0.0	1	0.0	1	0.0	1	0.0	1
C05-1	8.9	6	16.2	7	24.7	7	16.6	7
C05-3	10.9	7	10.2	4	9.7	4	10.3	4
C05a-3	0.1	2	0.3	2	0.7	2	0.4	2
C05b-1	4.0	4	11.8	6	20.8	6	12.2	6
C05b-3	0.9	3	1.0	3	1.5	3	1.1	3
C09-1	15.1	8	21.4	8	29.0	8	21.8	8
C13-1	4.1	5	11.6	5	20.1	5	11.9	5

Table L.29 – Loss of Load Probability for a Major (> 25,000 MWh) July Event, Final Screen Portfolios, Base Price Curve

Year	C05a-3Q, Preferred Portfolio	C05-1	C05-3	C05a-3	C05b-1	C05b-3	C09-1	C13-1
2015	0%	0%	0%	0%	0%	0%	0%	0%
2016	24%	24%	24%	24%	24%	24%	24%	24%
2017	28%	28%	28%	28%	28%	28%	28%	28%
2018	2%	2%	2%	2%	4%	2%	2%	2%
2019	0%	0%	0%	0%	0%	0%	0%	0%
2020	36%	36%	36%	36%	36%	36%	40%	36%
2021	18%	18%	18%	18%	18%	18%	22%	18%
2022	36%	50%	36%	36%	50%	36%	38%	50%
2023	40%	44%	40%	40%	44%	40%	40%	2%
2024	4%	4%	4%	4%	6%	4%	4%	0%
2025	32%	40%	34%	34%	40%	34%	32%	12%
2026	44%	46%	44%	44%	46%	44%	44%	6%
2027	48%	50%	48%	48%	50%	48%	48%	8%
2028	48%	46%	58%	50%	44%	50%	44%	2%
2029	12%	12%	22%	12%	8%	14%	8%	2%
2030	6%	10%	6%	8%	6%	8%	6%	2%
2031	56%	56%	56%	54%	56%	54%	56%	6%
2032	56%	58%	56%	56%	54%	56%	54%	6%
2033	56%	52%	56%	56%	50%	56%	54%	24%
2034	64%	64%	66%	64%	64%	68%	64%	16%

Table L.30 – Average Loss of Load Probability during Summer Peak, Final Screen Portfolios, Base Price Curve

Average for operating years 2015 through 2024								
Event Size (MWh)	C05a-3Q, Preferred Portfolio	C05-1	C05-3	C05a-3	C05b-1	C05b-3	C09-1	C13-1
> 0	100%	100%	100%	100%	100%	100%	100%	100%
> 1,000	100%	99%	100%	100%	99%	100%	100%	98%
> 10,000	50%	52%	51%	51%	52%	51%	52%	44%
> 25,000	19%	21%	19%	19%	21%	19%	20%	16%
> 50,000	1%	1%	1%	1%	2%	1%	1%	1%
> 100,000	0%	0%	0%	0%	0%	0%	0%	0%
> 500,000	0%	0%	0%	0%	0%	0%	0%	0%
Average for operating years 2015 through 2034								
Event Size (MWh)	C05a-3Q, Preferred Portfolio	C05-1	C05-3	C05a-3	C05b-1	C05b-3	C09-1	C13-1
> 0	100%	100%	100%	100%	100%	100%	100%	100%
> 1,000	99%	99%	99%	99%	99%	100%	99%	98%
> 10,000	64%	65%	65%	64%	65%	64%	64%	40%
> 25,000	31%	32%	32%	31%	31%	31%	30%	12%
> 50,000	5%	6%	7%	5%	6%	6%	4%	2%
> 100,000	1%	1%	1%	1%	1%	1%	0%	1%
> 500,000	0%	0%	0%	0%	0%	0%	0%	0%
> 1,000,000	0%	0%	0%	0%	0%	0%	0%	0%

APPENDIX M – CASE STUDY FACT SHEETS

Case Fact Sheet Overview

This appendix documents the 2015 Integrated Resource Plan modeling assumptions used for the Core Case studies and the Sensitivity Case studies. The Core Fact sheets were provided to the public to further discussion at the November 14, 2014 Public Input Meeting. These aided in the discussion during the public process and provided details beyond the high level summary tables. Sensitivities were discussed extensively at the January and February meetings. Those fact sheets are included following the Core Fact sheets.

Case Fact Sheets - Overview

Core Case Fact Sheets

The following Core Case Fact sheets summarize key assumptions and portfolio results for each portfolio being developed for the 2015 IRP. All cases produce resource portfolios capable of meeting state renewable portfolio standard requirements. Similarly, in addition to the specific 111(d) and Regional Haze compliance requirements specified for each case, all cases include costs to meet known and assumed compliance obligations for Mercury and Air Toxics (MATS), coal combustion residuals (CCR) under subtitle D of RCRA, cooling water intake structures under §316(b) of the Clean Water Act, and effluent guidelines.

Quick Reference Guide

Case	Reg. Haze [1]	111(d) Def. [2]	111(d) Strat. [3]	CO ₂ Price	Class 2 DSM [4]	FOTs	1 st Year of New Thermal	SO PVRW w/o Trans. (\$m)	SO PVRW w/ Trans. (\$m)
C01-R	Ref	None	None	None	Base	Base	2028	\$26,822	\$26,828
C01-1	1	None	None	None	Base	Base	2024	\$26,647	\$26,683
C01-2	2	None	None	None	Base	Base	2024	\$27,233	\$27,254
C02-1	1	1	A	None	Base	Base	2024	\$27,693	\$27,787
C02-2	2	1	A	None	Base	Base	2024	\$28,213	\$28,313
C03-1	1	1	B	None	Base+	Base	2028	\$28,835	\$28,889
C03-2	2	1	B	None	Base+	Base	2025	\$29,447	\$29,509
C04-1	1	1	C	None	Base+	Base	2028	\$29,111	\$29,310
C04-2	2	1	C	None	Base+	Base	2025	\$29,706	\$29,913
C05-1	1	2	A	None	Base	Base	2024	\$26,603	\$26,646
C05-2	2	2	A	None	Base	Base	2024	\$27,127	\$27,177
C05-3	3	2	A	None	Base	Base	2028	\$26,569	\$26,615
C05a-1	1	2	A	None	Base	Base	2024	\$26,566	\$26,591
C05b-1	1	2	A	None	Base	Base	2024	\$26,605	\$26,649
C05a-2	2	2	A	None	Base	Base	2024	\$27,190	\$27,240
C05a-3	3	2	A	None	Base	Base	2028	\$26,560	\$26,578
C05a-3Q	3	2	A	None	Base	Base	2028	\$26,570	\$26,591
C05b-3	3	2	A	None	Base	Base	2028	\$26,604	\$26,649
C06-1	1	2	B	None	Base+	Base	2028	\$27,919	\$27,930
C06-2	2	2	B	None	Base+	Base	2025	\$28,530	\$28,549
C07-1	1	2	C	None	Base+	Base	2028	\$28,449	\$28,516
C07-2	2	2	C	None	Base+	Base	2025	\$29,028	\$29,115
C09-1	1	2	A	None	Base	Limited	2022	\$26,764	\$26,809
C09-2	2	2	A	None	Base	Limited	2022	\$27,361	\$27,454
C11-1	1	2	A	None	Accelerated	Base	2024	\$26,612	\$26,649
C11-2	2	2	A	None	Accelerated	Base	2024	\$27,124	\$27,175
C12-1	1	3a	None	None	Base	Base	2024	\$26,638	\$26,655
C12-2	2	3a	None	None	Base	Base	2024	\$27,215	\$27,241
C13-1	1	3b	None	None	Base	Base	2023	\$26,860	\$26,902
C13-2	2	3b	None	None	Base	Base	2023	\$27,340	\$27,360
C14-1	1	2	A	Yes	Base	Base	2024	\$39,364	\$39,442
C14-2	2	2	A	Yes	Base	Base	2024	\$39,342	\$39,584
C14a-1	1	2	A	Yes	Base	Base	2022	\$39,229	\$39,304
C14a-2	2	2	A	Yes	Base	Base	2022	\$39,271	\$39,347

[1] Regional Haze assumptions are defined in the Core Case Fact Sheet for each case.

[2] 1 = 111(d) emission rate targets applied to PacifiCorp's system for states in which PacifiCorp has fossil generation; 2 = 111(d) emission rate targets applied to PacifiCorp's system for states in which PacifiCorp has fossil generation and retail customers; 3a = 111(d) implemented as a mass cap applicable to new and existing fossil resources in PacifiCorp's system; 3b = 111(d) implemented as a mass cap applicable to existing fossil resources in PacifiCorp's system

[3] A = cost-effective energy efficiency, fossil re-dispatch before adding new renewables; B = increased energy efficiency, fossil re-dispatch before adding new renewables; C = increased energy efficiency, new renewables before fossil re-dispatch

[4] Base = base Class 2 DSM achievable potential supply curves; Base+ = base Class 2 DSM achievable potential supply curves with forced selections of approximately 1.5% of retail sales; Accelerated = accelerated Class 2 DSM achievable potential supply curves

Case Fact Sheets - Overview

Sensitivity Fact Sheets

The following Sensitivity Fact sheets summarize key assumptions and portfolio results for each sensitivity being developed for the 2015 IRP. All sensitivities produce resource portfolios capable of meeting state renewable portfolio standard requirements. Similarly, in addition to the specific 111(d) and Regional Haze compliance requirements specified for each case, all cases include costs to meet known and assumed compliance obligations for Mercury and Air Toxics (MATS), coal combustion residuals (CCR) under subtitle D of RCRA, cooling water intake structures under §316(b) of the Clean Water Act, and effluent guidelines.

Quick Reference Guide

Case	Description	Reg. Haze[1]	111(d) Strat. [2]	CO ₂ Price	Class 2 DSM [3]	1 st Year of New Thermal	SO PVRR w/o Trans. (\$m)	SO PVRR w/ Trans. (\$m)
S-01	Low Load	1	A	None	Base	2028	\$24,680	\$24,715
S-02	High Load	1	A	None	Base	2020	\$28,269	\$28,334
S-03	1-in-20 Load	1	A	None	Base	2019	\$27,529	\$27,709
S-04	Low DG	1	A	None	Base	2024	\$26,843	\$26,885
S-05	High DG	1	A	None	Base	2027	\$25,987	\$26,016
S-06	Pumped Storage	1	A	None	Base	2028	\$27,022	\$27,094
S-07	Energy Gateway 2	1	C	None	Base+	2028	\$29,221	\$29,227
S-08	Energy Gateway 5	1	C	None	Base+	2028	\$29,966	\$29,977
S-09	PTC Extension	1	A	None	Base	2024	\$26,416	\$26,443
S-10_ECA	East BAA	3	A	None	Base	2028	\$19,377	\$19,672
S-10_WCA	West BAA	3	A	None	Base	2020	\$8,096	\$8,129
S-10_System	Benchmark System	3	A	None	Base	2028	\$26,460	\$26,480
S-11	111(d) and High CO ₂ Price	1	A	High	Base	2024	\$44,629	\$45,091
S-12	Stakeholder Solar Cost Assumptions	1	A	None	Base	2027	\$25,993	\$26,029
S-13	Compressed Air Storage	1	A	None	Base	2027	\$26,950	\$27,046
S-14	Class 3 DSM	1	A	None	Base	2024	\$26,565	\$26,602
S-15	Restricted 111(d) Attributes	1	A	None	Base	2020	\$26,985	\$27,057

[1] Regional Haze assumptions are defined in the Core Case Fact Sheet for each case.

[2] A = cost-effective energy efficiency, fossil re-dispatch before adding new renewables; C = increased energy efficiency, new renewables before fossil re-dispatch

[3] Base = base Class 2 DSM achievable potential supply curves; Base+ = base Class 2 DSM achievable potential supply curves with forced selections of approximately 1.5% of retail sales;

Additional notes:

All Sensitivities incorporate: 111(d) emission rate targets applied to PacifiCorp's system for states in which PacifiCorp has fossil generation and retail customers;

Case: C01-R

CASE ASSUMPTIONS

Description

Case C01-R is a reference case that assumes known and potential future Regional Haze requirements for installation of selective catalytic reduction (SCR) without any future requirements to reduce CO₂ emissions, whether through a CO₂ price or 111(d) regulation.

Federal CO₂ Policy/Price Signal

None.

Forward Price Curve

Case C01-R gas and power prices utilize medium natural gas price assumptions consistent with the Company's September 30, 2014 OFPC through 2018 without incorporating 111(d) impacts. Post-2018 prices are followed by a 12-month blend that segues into a pure fundamentals forecast.

Nominal Average Annual Henry Hub Gas Prices

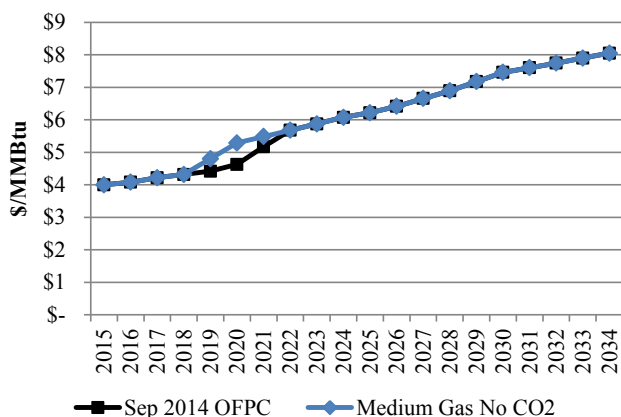

Nominal Average Annual Power Prices (Flat)

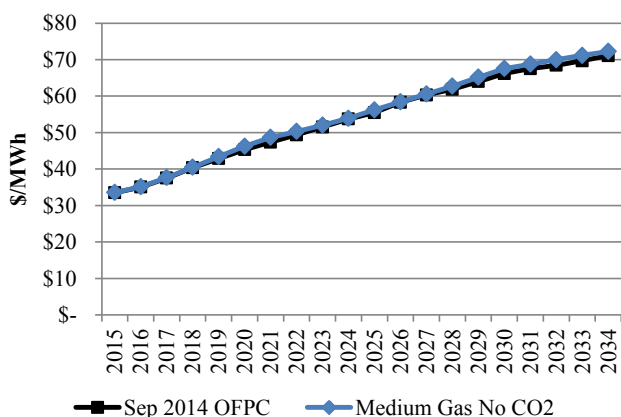

Regional Haze

C01-R Regional Haze assumptions are summarized in the following table.

Coal Unit	Description
Carbon 1	Shut Down Apr 2015
Carbon 2	Shut Down Apr 2015
Cholla 4	SCR by Dec 2017
Colstrip 3	SCR by Dec 2023

Coal Unit	Description
Colstrip 4	SCR by Dec 2022
Craig 1	SCR by Aug 2021
Craig 2	SCR by Jan 2018
Dave Johnson 1	Shut Down Dec 2027
Dave Johnson 2	Shut Down Dec 2027
Dave Johnson 3	SCR by Mar 2019, Shut Down Dec 2027
Dave Johnson 4	Shut Down Dec 2027
Hayden 1	SCR by Jun 2015
Hayden 2	SCR by Jun 2016
Hunter 1	SCR by Dec 2021
Hunter 2	SCR by Dec 2021
Hunter 3	SCR by Dec 2024
Huntington 1	SCR by Dec 2022
Huntington 2	SCR by Dec 2022
Jim Bridger 1	SCR by Dec 2022
Jim Bridger 2	SCR by Dec 2021
Jim Bridger 3	SCR by Dec 2015
Jim Bridger 4	SCR by Dec 2016
Naughton 1	Shut Down by Dec 2029
Naughton 2	Shut Down by Dec 2029
Naughton 3	Conversion by Jun 2018; Shut Down by Dec 2029
Wyodak	SCR by Mar 2019

SCR = selective catalytic reduction

Federal Tax Incentives

- PTCs expire end of 2013
- ITC of 30% expire end of 2016, thereafter it continues in perpetuity at 10%.

Load Forecast

The figure below shows the medium system coincident peak load forecast applicable to this case before accounting for any potential contribution from DSM or distributed generation resources.

Coincident System Peak Load

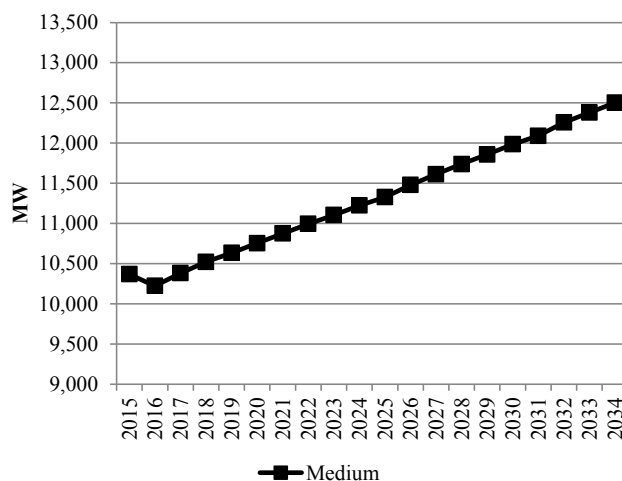

Case: C01-R

Energy Efficiency (Class 2 DSM)

This case uses base supply curves with economic resource selections up to the achievable potential. Class 2 resources that are not selected in any given year are not available for selection in future years. Achievable potential by state and year are summarized below.

Class 2 DSM Cumulative Achievable Potential

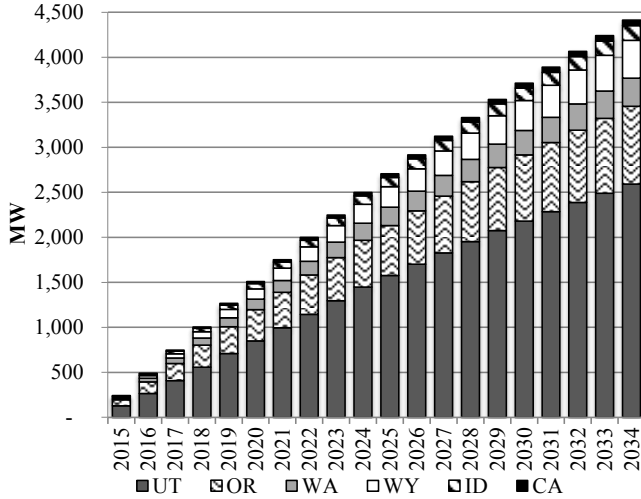

Distributed Generation

Base case distributed generation penetration is assumed in all states. Distributed generation by state and year are summarized in the following figure.

Distributed Generation - Base PenetrationCase

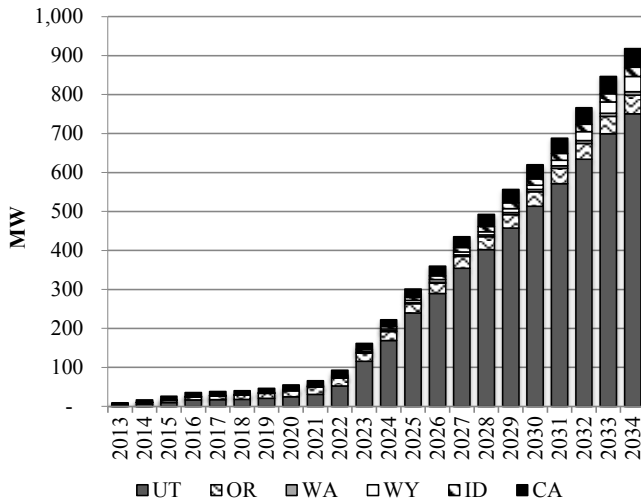

PORTFOLIO SUMMARY

System Optimizer PVRR (\$m)

System Cost without Transmission Upgrades	\$26,822
Transmission Upgrades	\$6
Total Cost	\$26,828

Resource Portfolio

Cumulative changes to the resource portfolio (new resource additions and resource retirements), represented as nameplate capacity, are summarized in the figure below.

Cumulative Nameplate Capacity

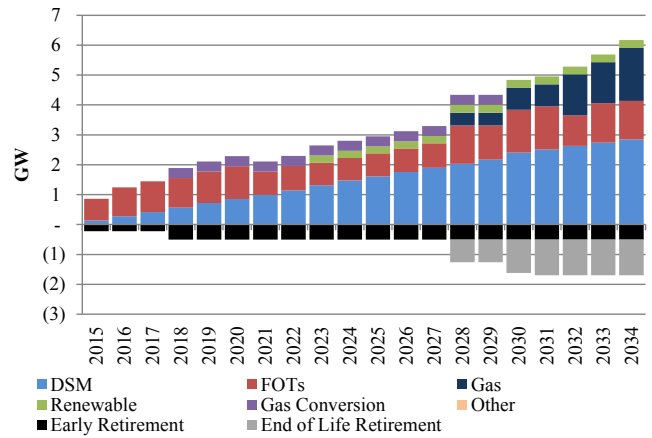

System CO₂ Emissions (System Optimizer)

System CO₂ emissions from System Optimizer are shown in the figure below.

System CO₂ Emissions (System Optimizer)

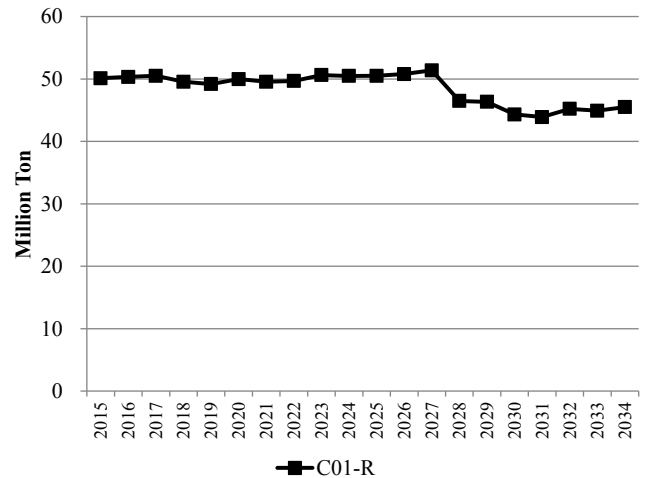

CASE ASSUMPTIONS

Description

Case C01-1 is a reference case that, for planning purposes, assumes one of two different Regional Haze compliance scenarios reflecting potential inter-temporal and fleet trade-off compliance outcomes. This case produces a portfolio without any future requirements to reduce CO₂ emissions, whether through a CO₂ price or 111(d) regulation.

Federal CO₂ Policy/Price Signal

None.

Forward Price Curve

Case C01-1 gas and power prices utilize medium natural gas price assumptions consistent with the Company's September 30, 2014 OFPC through 2018 without incorporating 111(d) impacts. Post-2018 prices are followed by a 12-month blend that segues into a pure fundamentals forecast.

Nominal Average Annual Henry Hub Gas Prices

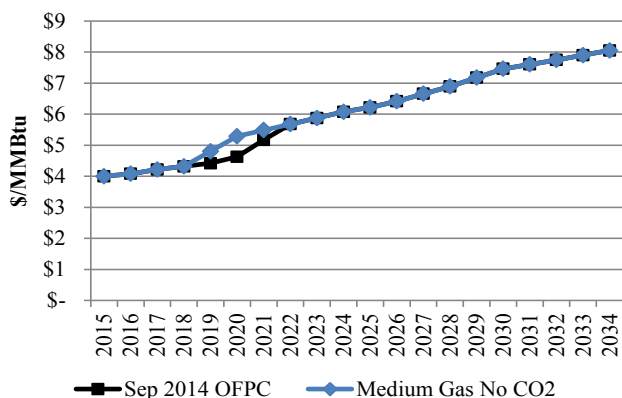

Nominal Average Annual Power Prices (Flat)

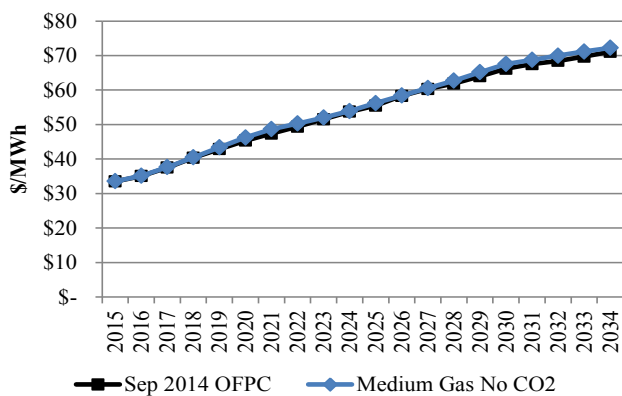

Regional Haze

Case C01-1 reflects Regional Haze Scenario 1, which assumes inter-temporal and fleet trade-off Regional Haze compliance outcomes as shown in the table below. This scenario is for planning purposes recognizing that agency, regulator, and joint owner perspectives on acceptability have not been determined.

Coal Unit	Description
Carbon 1	Shut Down Apr 2015
Carbon 2	Shut Down Apr 2015
Cholla 4	Conversion by Jun 2025
Colstrip 3	SCR by Dec 2023
Colstrip 4	SCR by Dec 2022
Craig 1	SCR by Aug 2021
Craig 2	SCR by Jan 2018
Dave Johnston 1	Shut Down Mar 2019
Dave Johnston 2	Shut Down Dec 2027
Dave Johnston 3	Shut Down Dec 2027
Dave Johnston 4	Shut Down Dec 2032
Hayden 1	SCR by Jun 2015
Hayden 2	SCR by Jun 2016
Hunter 1	SCR by Dec 2021
Hunter 2	Shut Down by Dec 2032
Hunter 3	SCR by Dec 2024
Huntington 1	Shut Down by Dec 2036
Huntington 2	Shut Down by Dec 2021
Jim Bridger 1	Shut Down by Dec 2023
Jim Bridger 2	Shut Down by Dec 2032
Jim Bridger 3	SCR by Dec 2015
Jim Bridger 4	SCR by Dec 2016
Naughton 1	Shut Down by Dec 2029
Naughton 2	Shut Down by Dec 2029
Naughton 3	Conversion by Jun 2018; Shut Down by Dec 2029
Wyodak	Shut Down by Dec 2039

SCR = selective catalytic reduction

Federal Tax Incentives

- PTCs expire end of 2013
- ITC of 30% expire end of 2016, thereafter it continues in perpetuity at 10%.

Load Forecast

The following figure shows the medium system coincident peak load forecast applicable to this case before accounting for any potential contribution from DSM or distributed generation resources.

Coincident System Peak Load

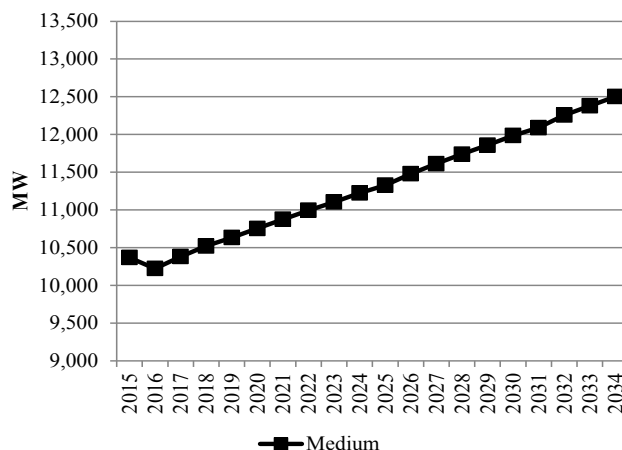

Case: C01-1

Energy Efficiency (Class 2 DSM)

This case uses base supply curves with economic resource selections up to the achievable potential. Class 2 resources that are not selected in any given year are not available for selection in future years. Achievable potential by state and year are summarized below.

Class 2 DSM Cumulative Achievable Potential

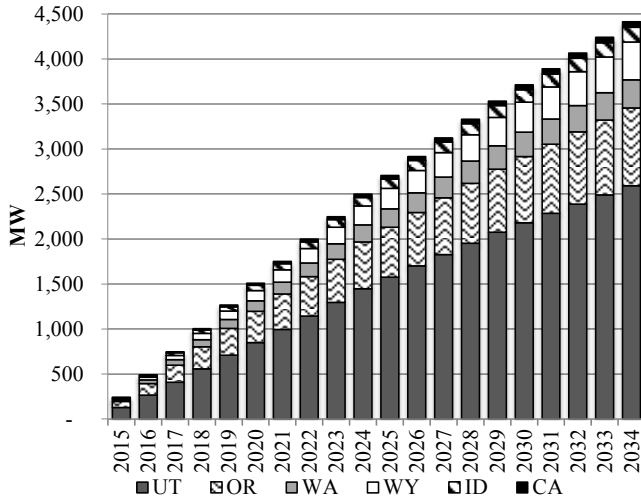

Distributed Generation

Base case distributed generation penetration is assumed in all states. Distributed generation by state and year are summarized in the following figure.

Distributed Generation - Base Penetration Case

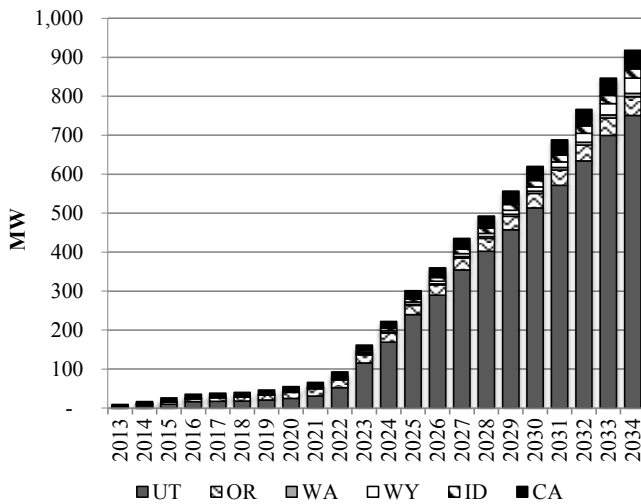

PORTFOLIO SUMMARY

System Optimizer PVRR (\$m)

System Cost without Transmission Upgrades	\$26,647
Transmission Integration	\$30
Transmission Reinforcement	\$6
Total Cost	\$26,683

Resource Portfolio

Cumulative changes to the resource portfolio (new resource additions and resource retirements), represented as nameplate capacity, are summarized in the figure below.

Cumulative Nameplate Capacity

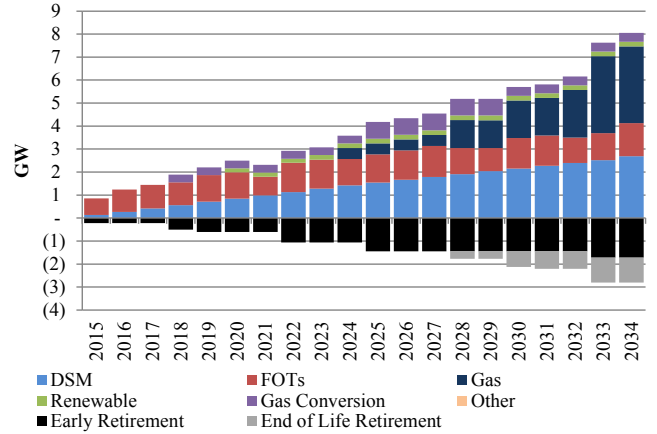

System CO₂ Emissions (System Optimizer)

System CO₂ emissions from System Optimizer are shown alongside those from Case C01-R in the figure below.

System CO₂ Emissions (System Optimizer)

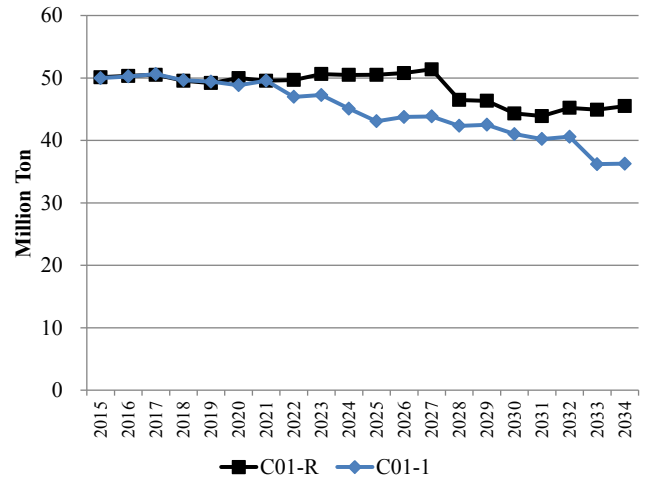

111(d) Compliance Profiles

Not applicable.

Case: C01-2

CASE ASSUMPTIONS

Description

Case C01-2 is a reference case that, for planning purposes, assumes one of two different Regional Haze compliance scenarios reflecting potential inter-temporal and fleet trade-off compliance outcomes. This case produces a portfolio without any future requirements to reduce CO₂ emissions, whether through a CO₂ price or 111(d) regulation.

Federal CO₂ Policy/Price Signal

None.

Forward Price Curve

Case C01-2 gas and power prices utilize medium natural gas price assumptions consistent with the Company's September 30, 2014 OFPC through 2018 without incorporating 111(d) impacts. Post-2018 prices are followed by a 12-month blend that segues into a pure fundamentals forecast.

Nominal Average Annual Henry Hub Gas Prices

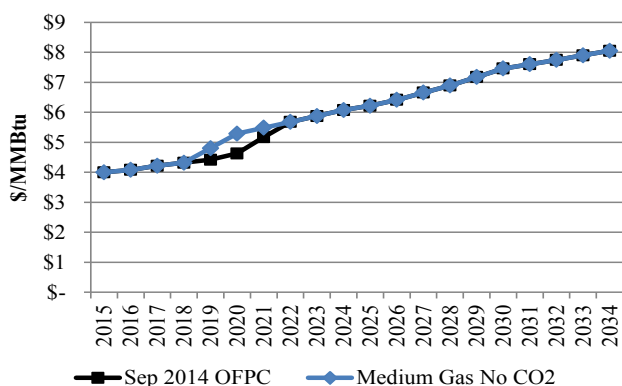

Nominal Average Annual Power Prices (Flat)

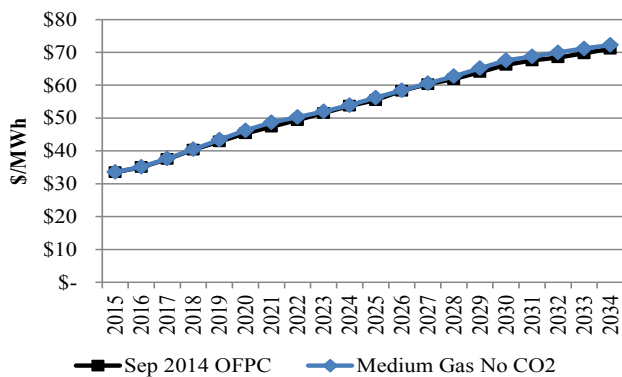

Regional Haze

Case C01-2 reflects Regional Haze Scenario 2, which assumes inter-temporal and fleet trade-off Regional Haze compliance outcomes as shown in the table below. This scenario is for planning purposes recognizing that agency, regulator, and joint owner perspectives on acceptability have not been determined.

Coal Unit	Description
Carbon 1	Shut Down Apr 2015
Carbon 2	Shut Down Apr 2015
Cholla 4	Conversion by Jun 2025
Colstrip 3	SCR by Dec 2023
Colstrip 4	SCR by Dec 2022
Craig 1	SCR by Aug 2021
Craig 2	SCR by Jan 2018
Dave Johnson 1	Shut Down Mar 2019
Dave Johnson 2	Shut Down Dec 2023
Dave Johnson 3	Shut Down Dec 2027
Dave Johnson 4	Shut Down Dec 2032
Hayden 1	SCR by Jun 2015
Hayden 2	SCR by Jun 2016
Hunter 1	SCR by Dec 2021
Hunter 2	Shut Down Dec 2024
Hunter 3	SCR by Dec 2024
Huntington 1	Shut Down Dec 2024
Huntington 2	Shut Down by Dec 2021
Jim Bridger 1	Shut Down by Dec 2023
Jim Bridger 2	Shut Down by Dec 2028
Jim Bridger 3	SCR by Dec 2015
Jim Bridger 4	SCR by Dec 2016
Naughton 1	Shut Down by Dec 2029
Naughton 2	Shut Down by Dec 2029
Naughton 3	Conversion by Jun 2018; Shut Down by Dec 2029
Wyodak	Shut Down by Dec 2032

* SCR = selective catalytic reduction

Federal Tax Incentives

- PTCs expire end of 2013
- ITC of 30% expire end of 2016, thereafter it continues in perpetuity at 10%.

Load Forecast

The figure below shows the medium system coincident peak load forecast applicable to this case before accounting for any potential contribution from DSM or distributed generation resources.

Coincident System Peak Load

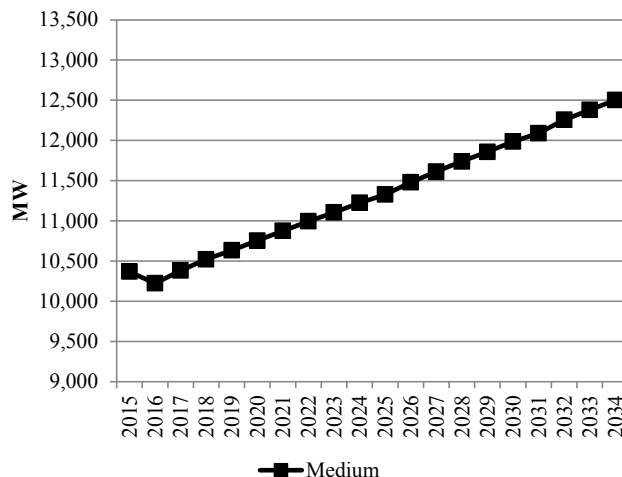

Case: C01-2

Energy Efficiency (Class 2 DSM)

This case uses base supply curves with economic resource selections up to the achievable potential. Class 2 resources that are not selected in any given year are not available for selection in future years. Achievable potential by state and year are summarized below.

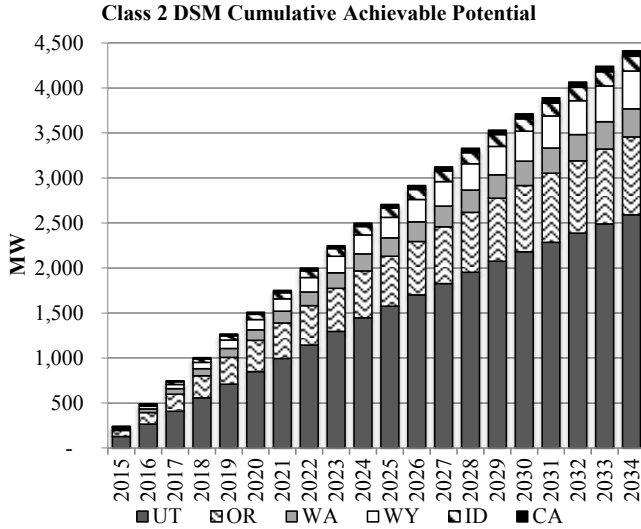

Distributed Generation

Base case distributed generation penetration is assumed in all states. Distributed generation by state and year are summarized in the following figure.

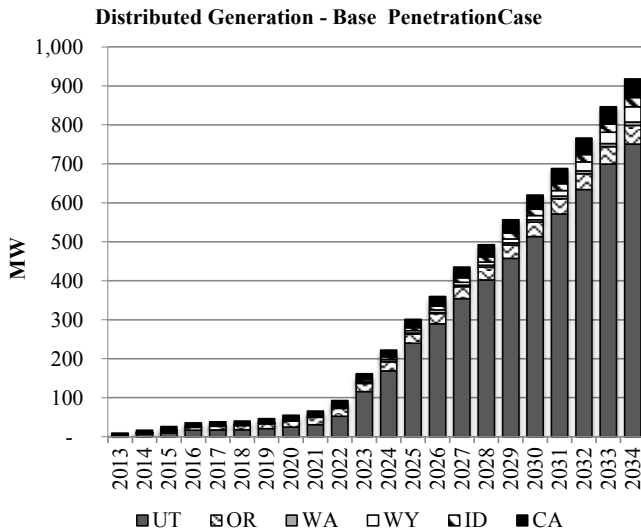

PORTFOLIO SUMMARY

System Optimizer PVRR (\$m)

System Cost without Transmission Upgrades	\$27,233
Transmission Integration	\$11
Transmission Reinforcement	\$10
Total Cost	\$27,254

Resource Portfolio

Cumulative changes to the resource portfolio (new resource additions and resource retirements), represented as nameplate capacity, are summarized in the figure below.

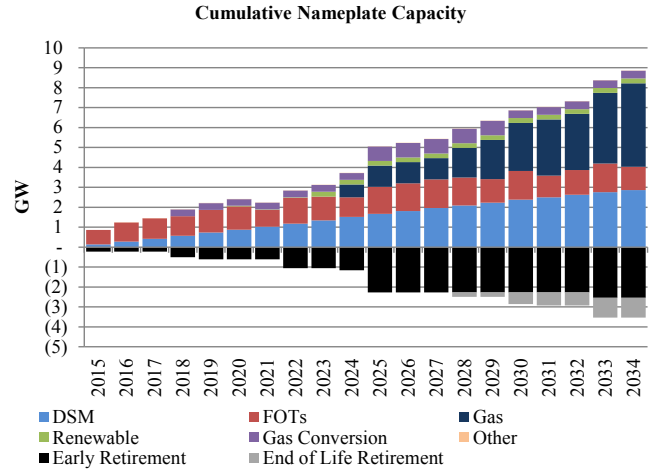

System CO₂ Emissions (System Optimizer)

System CO₂ emissions from System Optimizer are shown alongside those from Case C01-R in the figure below.

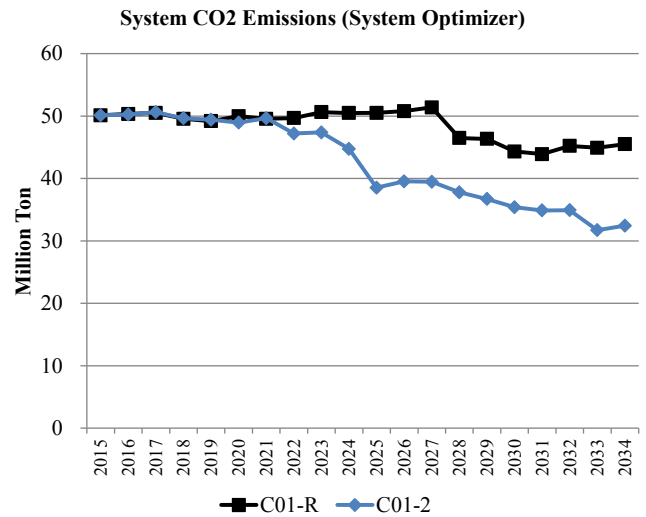

111(d) Compliance Profiles

Not applicable.

CASE ASSUMPTIONS

Description

Case C02-1 produces a portfolio that meets PacifiCorp’s share of state 111(d) emission rate goals in all states in which PacifiCorp owns fossil generation. The compliance strategy applied to this case relies on flexible allocation of renewable energy and energy efficiency while prioritizing re-dispatch of fossil generation to achieve incremental emission rate reductions as required. For planning purposes, this case assumes one of two different Regional Haze compliance scenarios reflecting potential inter-temporal and fleet trade-off compliance outcomes.

Federal CO₂ Policy/Price Signal

C02-1 reflects EPA’s proposed 111(d) rule with no additional CO₂ price signal. The table below summarizes the interim emission rate goal and the final emission rate target by state assumed to apply to PacifiCorp’s system.

State	Interim Goal (Avg. 2020-2029) (lb/MWh)	Final Target (2030 & Beyond) (lb/MWh)
WY	1,808	1,714
UT*	1,378	1,322
OR	407	372
WA	264	215
MT	1,882	1,771
CO	1,159	1,108
AZ	753	702

*EPA’s calculation of the target for UT treated PacifiCorp’s Lakeside 2 NGCC plant as an existing resource. The emission rate assumed for UT assumes Lake Side 2 is correctly classified as “under construction”.

The 111(d) compliance strategy implemented for this case is summarized as follows:

- Flexible allocation of system renewable resources and flexible allocation of cumulative energy efficiency savings beginning 2017 from ID and CA, where PacifiCorp does not own fossil generation.
- Cumulative cost-effective selection of energy efficiency beginning 2017.
- New NGCC generation in WY and UT (new NGCC resources are not allowed in OR, WA, and ID).
- Re-dispatch of existing fossil generation, as required.
- Addition of new renewable resources, as required.

Forward Price Curve

Case C02-1 gas and power prices reflect medium natural gas prices and regional compliance with EPA’s proposed 111(d) rule as implemented in the Company’s September 2014 official forward price curve (OFPC).

Nominal Average Annual Henry Hub Gas Prices

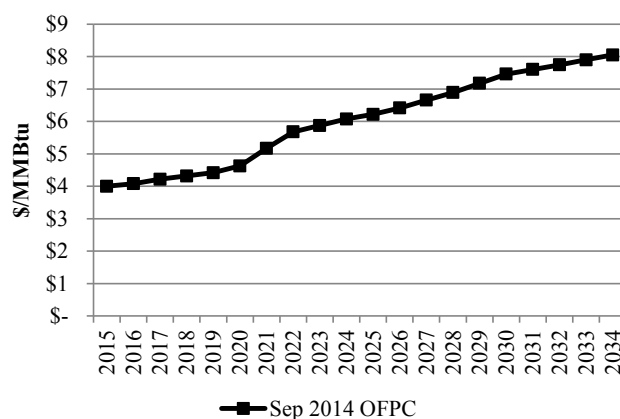

Nominal Average Annual Power Prices (Flat)

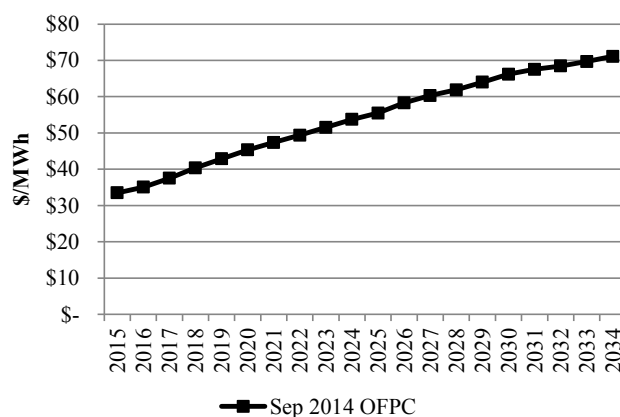

Regional Haze

Case C02-1 reflects Regional Haze Scenario 1, which assumes inter-temporal and fleet trade-off Regional Haze compliance outcomes as shown in the table below. This scenario is for planning purposes recognizing that agency, regulator, and joint owner perspectives on acceptability have not been determined.

Coal Unit	Description
Carbon 1	Shut Down Apr 2015
Carbon 2	Shut Down Apr 2015
Cholla 4	Conversion by Jun 2025
Colstrip 3	SCR by Dec 2023
Colstrip 4	SCR by Dec 2022
Craig 1	SCR by Aug 2021
Craig 2	SCR by Jan 2018
Dave Johnston 1	Shut Down Mar 2019
Dave Johnston 2	Shut Down Dec 2027
Dave Johnston 3	Shut Down Dec 2027
Dave Johnston 4	Shut Down Dec 2032
Hayden 1	SCR by Jun 2015
Hayden 2	SCR by Jun 2016
Hunter 1	SCR by Dec 2021
Hunter 2	Shut Down by Dec 2032
Hunter 3	SCR by Dec 2024

Case: C02-1

Coal Unit	Description
Huntington 1	Shut Down by Dec 2036
Huntington 2	Shut Down by Dec 2021
Jim Bridger 1	Shut Down by Dec 2023
Jim Bridger 2	Shut Down by Dec 2032
Jim Bridger 3	SCR by Dec 2015
Jim Bridger 4	SCR by Dec 2016
Naughton 1	Shut Down by Dec 2029
Naughton 2	Shut Down by Dec 2029
Naughton 3	Conversion by Jun 2018; Shut Down by Dec 2029
Wyodak	Shut Down by Dec 2039

*SCR = selective catalytic reduction

Federal Tax Incentives

- PTCs expire end of 2013
- ITC of 30% expire end of 2016, thereafter it continues in perpetuity at 10%.

Load Forecast

The figure below shows the medium system coincident peak load forecast applicable to this case before accounting for any potential contribution from DSM or distributed generation resources.

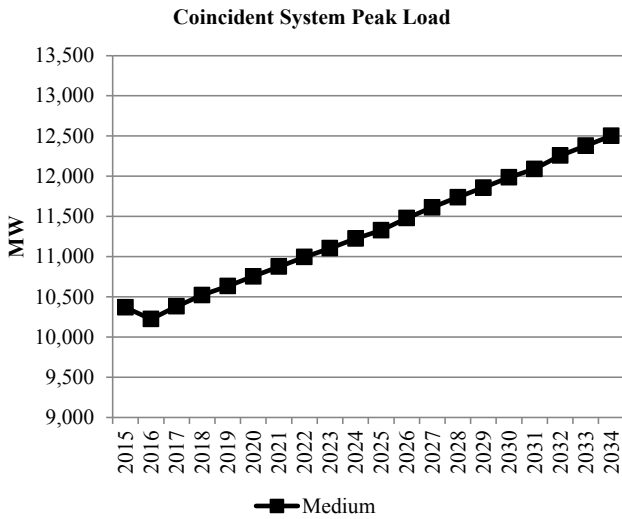

Energy Efficiency (Class 2 DSM)

This case uses base supply curves with economic resource selections up to the achievable potential. Class 2 resources that are not selected in any given year are not available for selection in future years. Achievable potential by state and year are summarized in the following figure.

Class 2 DSM Cumulative Achievable Potential

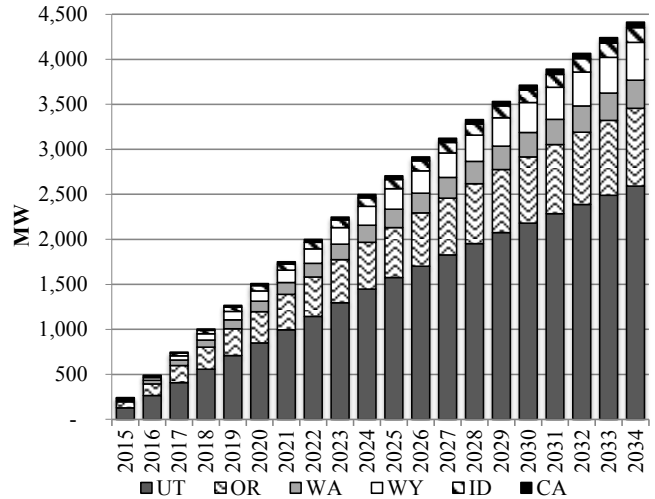

Distributed Generation

Base case distributed generation penetration is assumed in all states. Distributed generation by state and year are summarized in the following figure.

Distributed Generation - Base Penetration Case

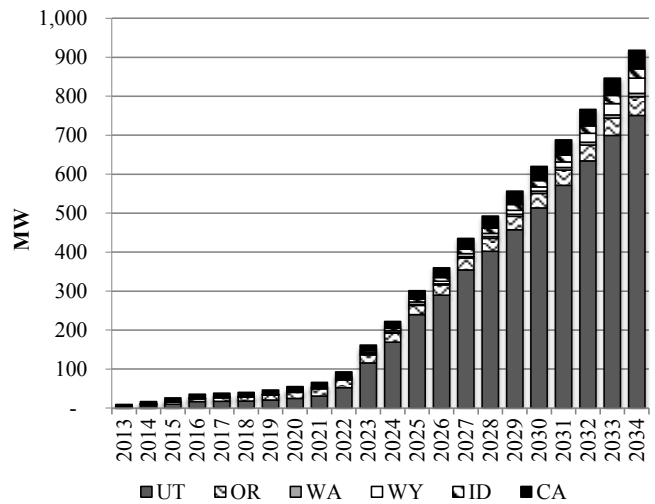

PORTFOLIO SUMMARY

System Optimizer PVRR (\$m)

System Cost without Transmission Upgrades	\$27,693
Transmission Integration	\$87
Transmission Reinforcement	\$6
Total Cost	\$27,787

Resource Portfolio

Cumulative changes to the resource portfolio (new resource additions and resource retirements), represented as nameplate capacity, are summarized in the following figure.

Case: C02-1

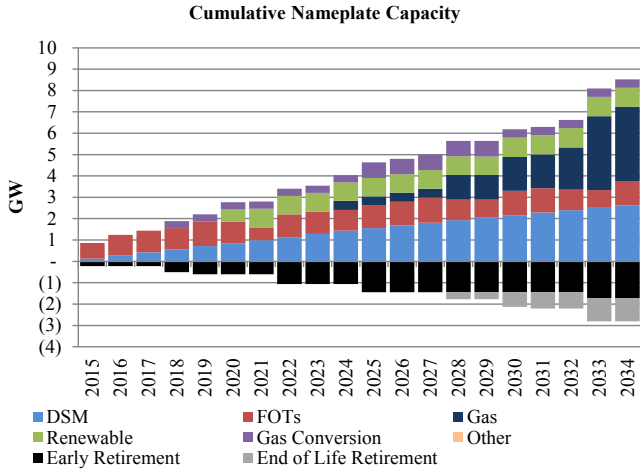

System CO₂ Emissions (System Optimizer)

System CO₂ emissions from System Optimizer are shown alongside those from Cases C01-R and C01-1 in the figure below.

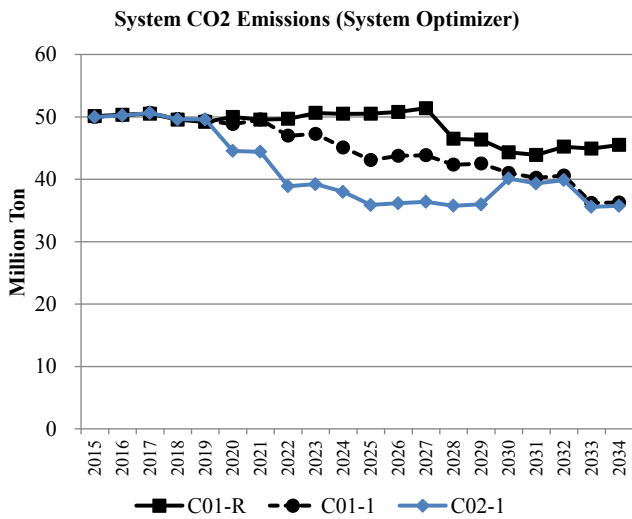

111(d) Compliance Profiles

The following figures summarize how compliance with state emission rate goals is achieved. The sum of each stacked bar represents the fossil emission rate. The net final rate represents the fossil rate after accounting for the emission rate impacts of new thermal (new NGCC units or nuclear, as applicable), re-dispatch of fossil units, energy efficiency (EE), and allocated renewable energy (RE).

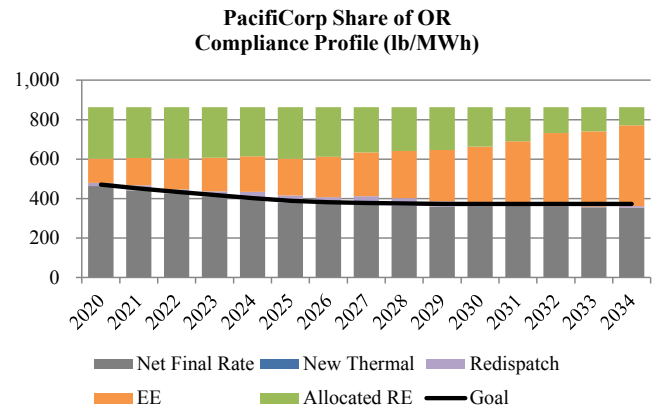
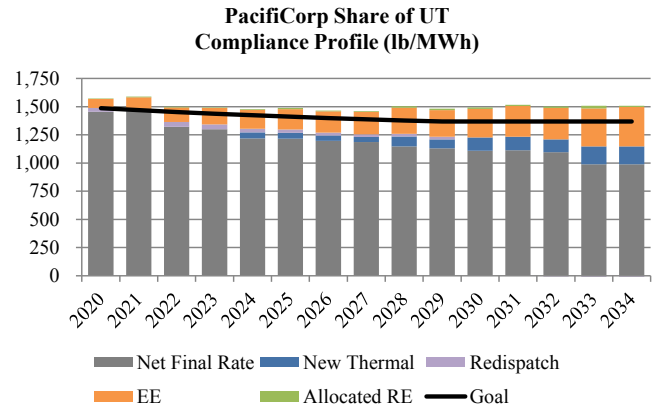
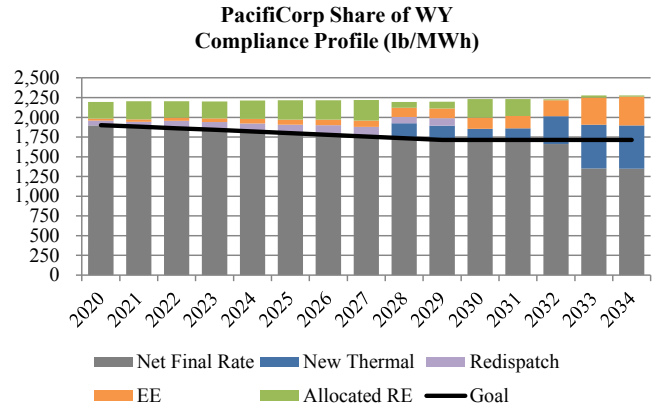

Case: C02-1

PacifiCorp Share of WA Compliance Profile (lb/MWh)

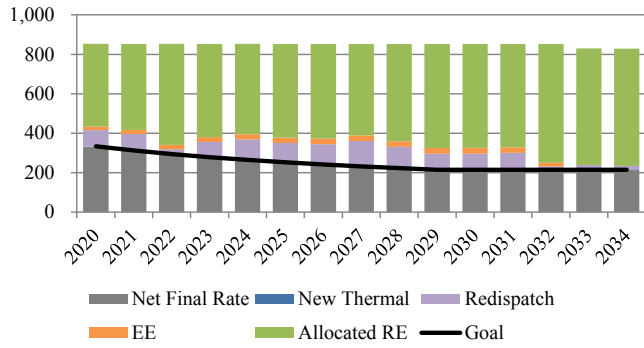

PacifiCorp's Share of AZ Compliance Profile (lb/MWh)

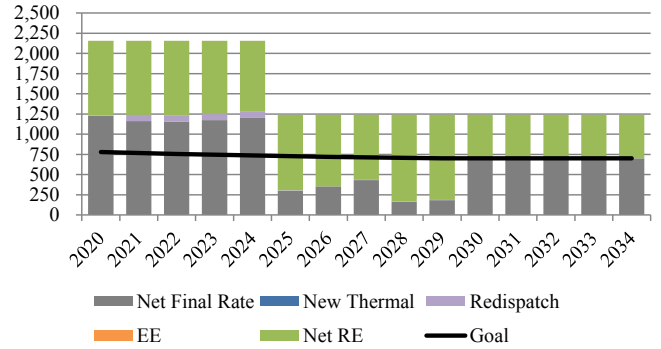

PacifiCorp's Share of MT Compliance Profile (lb/MWh)

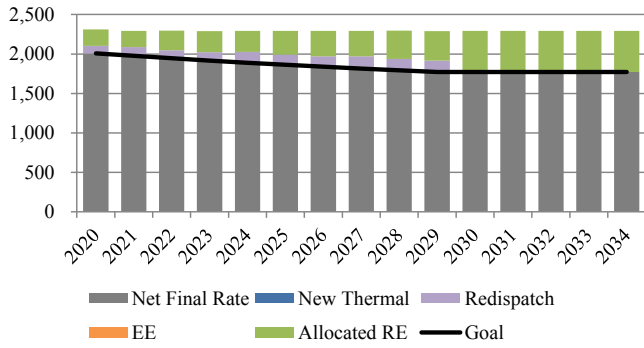

PacifiCorp's Share of CO Compliance Profile (lb/MWh)

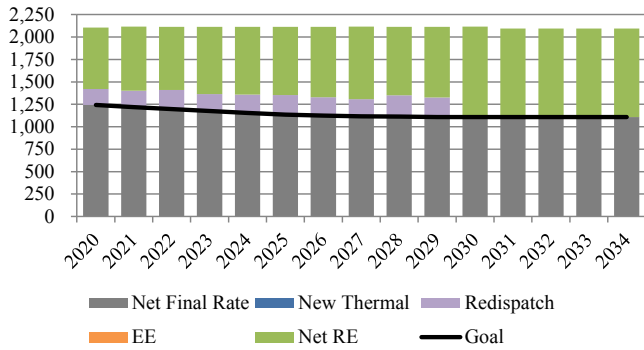

CASE ASSUMPTIONS

Description

Case C02-2 produces a portfolio that meets PacifiCorp’s share of state 111(d) emission rate goals in all states in which PacifiCorp owns fossil generation. The compliance strategy applied to this case relies on flexible allocation of renewable energy and energy efficiency while prioritizing re-dispatch of fossil generation to achieve incremental emission rate reductions as required. For planning purposes, this case assumes one of two different Regional Haze compliance scenarios reflecting potential inter-temporal and fleet trade-off compliance outcomes.

Federal CO₂ Policy/Price Signal

C02-2 reflects EPA’s proposed 111(d) rule with no additional CO₂ price signal. The table below summarizes the interim emission rate goal and the final emission rate target by state assumed to apply to PacifiCorp’s system.

State	Interim Goal (Avg. 2020-2029) (lb/MWh)	Final Target (2030 & Beyond) (lb/MWh)
WY	1,808	1,714
UT*	1,378	1,322
OR	407	372
WA	264	215
MT	1,882	1,771
CO	1,159	1,108
AZ	753	702

*EPA’s calculation of the target for UT treated PacifiCorp’s Lakeside 2 NGCC plant as an existing resource. The emission rate assumed for UT assumes Lake Side 2 is correctly classified as “under construction”.

The 111(d) compliance strategy implemented for this case is summarized as follows:

- Flexible allocation of system renewable resources and flexible allocation of cumulative energy efficiency savings beginning 2017 from ID and CA, where PacifiCorp does not own fossil generation.
- Cumulative cost-effective selection of energy efficiency beginning 2017.
- New NGCC generation in WY and UT (new NGCC resources are not allowed in OR, WA, and ID).
- Re-dispatch of existing fossil generation, as required.
- Addition of new renewable resources, as required.

Forward Price Curve

Case C02-2 gas and power prices reflect medium natural gas prices and regional compliance with EPA’s proposed 111(d) rule as implemented in the Company’s September 2014 official forward price curve (OFPC).

Nominal Average Annual Henry Hub Gas Prices

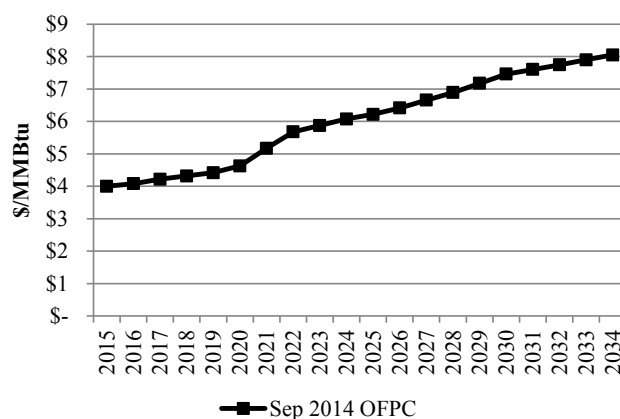

Nominal Average Annual Power Prices (Flat)

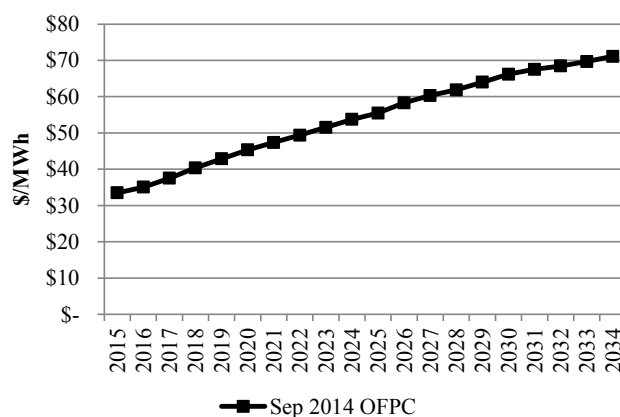

Regional Haze

Case C02-2 reflects Regional Haze Scenario 2, which assumes inter-temporal and fleet trade-off Regional Haze compliance outcomes as shown in the table below. This scenario is for planning purposes recognizing that agency, regulator, and joint owner perspectives on acceptability have not been determined.

Coal Unit	Description
Carbon 1	Shut Down Apr 2015
Carbon 2	Shut Down Apr 2015
Cholla 4	Conversion by Jun 2025
Colstrip 3	SCR by Dec 2023
Colstrip 4	SCR by Dec 2022
Craig 1	SCR by Aug 2021
Craig 2	SCR by Jan 2018
Dave Johnson 1	Shut Down Mar 2019
Dave Johnson 2	Shut Down Dec 2023
Dave Johnson 3	Shut Down Dec 2027
Dave Johnson 4	Shut Down Dec 2032
Hayden 1	SCR by Jun 2015
Hayden 2	SCR by Jun 2016
Hunter 1	SCR by Dec 2021
Hunter 2	Shut Down Dec 2024
Hunter 3	SCR by Dec 2024
Huntington 1	Shut Down Dec 2024

Case: C02-2

Coal Unit	Description
Huntington 2	Shut Down by Dec 2021
Jim Bridger 1	Shut Down by Dec 2023
Jim Bridger 2	Shut Down by Dec 2028
Jim Bridger 3	SCR by Dec 2015
Jim Bridger 4	SCR by Dec 2016
Naughton 1	Shut Down by Dec 2029
Naughton 2	Shut Down by Dec 2029
Naughton 3	Conversion by Jun 2018; Shut Down by Dec 2029
Wyodak	Shut Down by Dec 2032

*SCR = selective catalytic reduction

Federal Tax Incentives

- PTCs expire end of 2013
- ITC of 30% expire end of 2016, thereafter it continues in perpetuity at 10%.

Load Forecast

The figure below shows the medium system coincident peak load forecast applicable to this case before accounting for any potential contribution from DSM or distributed generation resources.

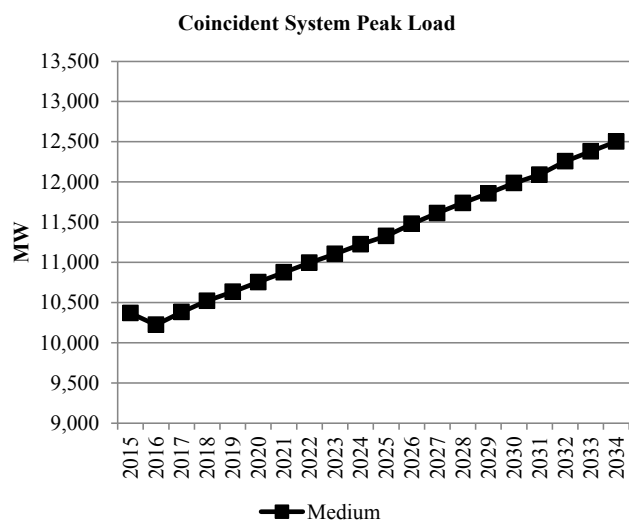

Energy Efficiency (Class 2 DSM)

This case uses base supply curves with economic resource selections up to the achievable potential. Class 2 resources that are not selected in any given year are not available for selection in future years. Achievable potential by state and year are summarized in the following figure.

Class 2 DSM Cumulative Achievable Potential

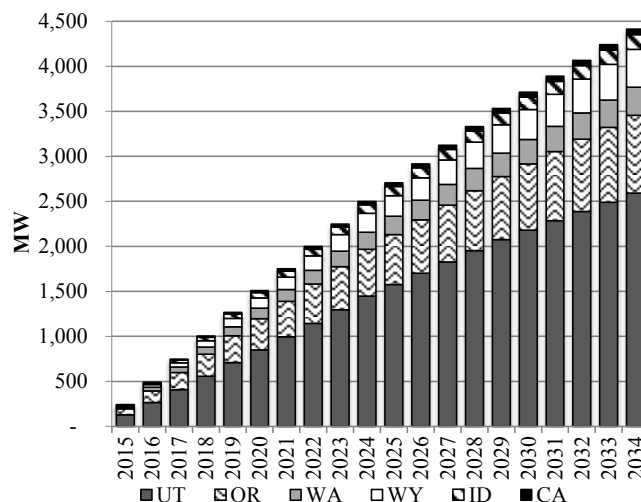

Distributed Generation

Base case distributed generation penetration is assumed in all states. Distributed generation by state and year are summarized below.

Distributed Generation - Base Penetration Case

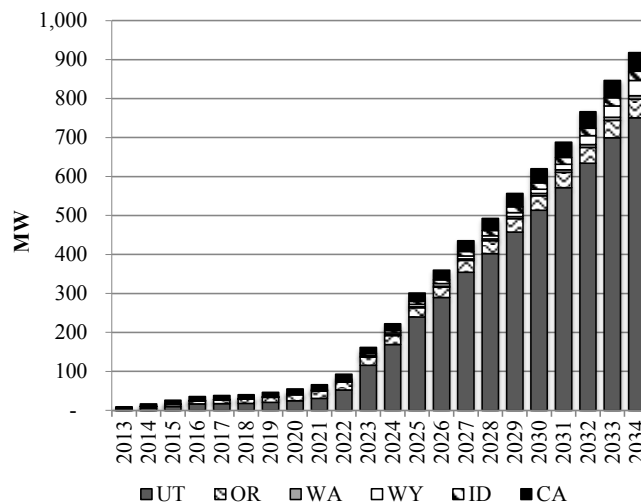

PORTFOLIO SUMMARY

System Optimizer PVRR (\$m)

System Cost without Transmission Upgrades	\$28,213
Transmission Integration	\$91
Transmission Reinforcement	\$10
Total Cost	\$28,313

Resource Portfolio

Cumulative changes to the resource portfolio (new resource additions and resource retirements), represented as nameplate capacity, are summarized in the following figure.

Case: C02-2

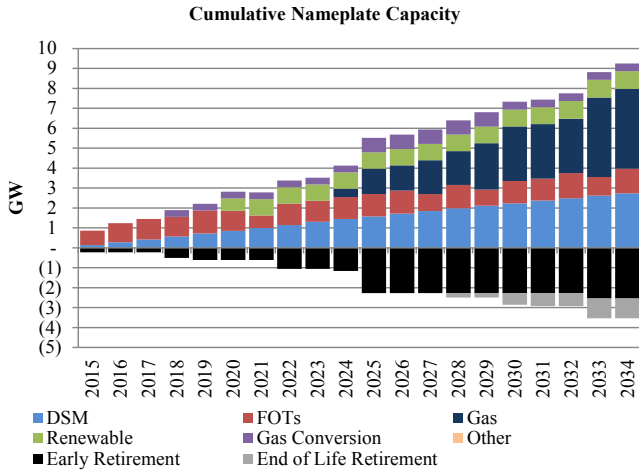

System CO₂ Emissions (System Optimizer)

System CO₂ emissions from System Optimizer are shown alongside those from Cases C01-R and C01-2 in the figure below.

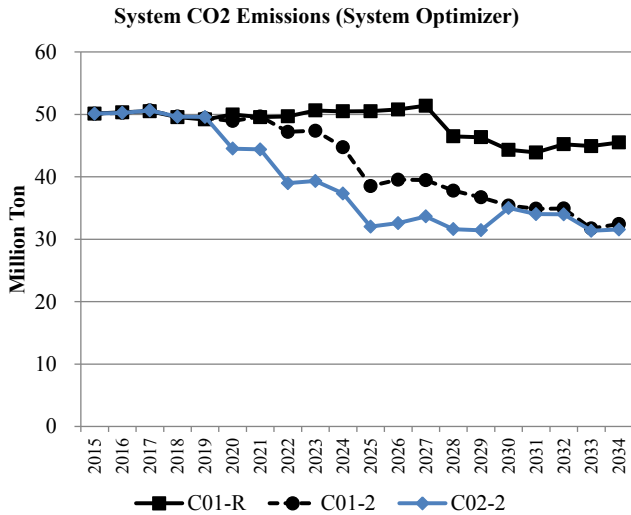

111(d) Compliance Profiles

The following figures summarize how compliance with state emission rate goals is achieved. The sum of each stacked bar represents the fossil emission rate. The net final rate represents the fossil rate after accounting for the emission rate impacts of new thermal (new NGCC units or nuclear, as applicable), re-dispatch of fossil units, energy efficiency (EE), and allocated renewable energy (RE).

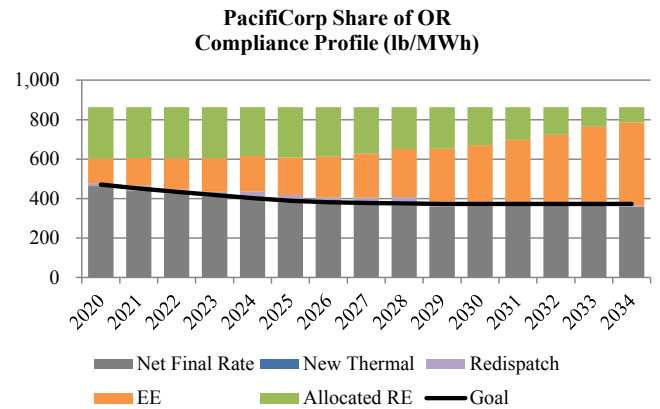
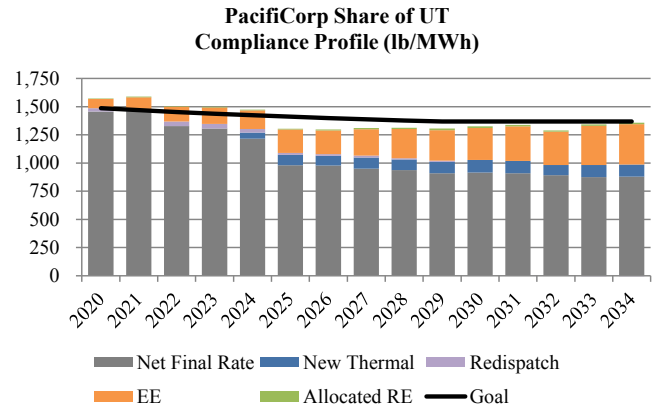
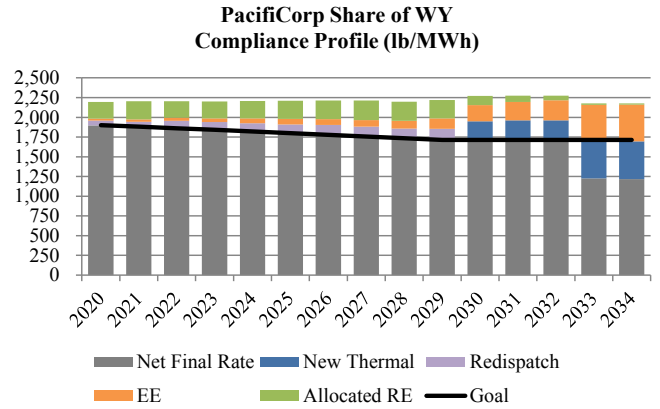

Case: C02-2

PacifiCorp Share of WA Compliance Profile (lb/MWh)

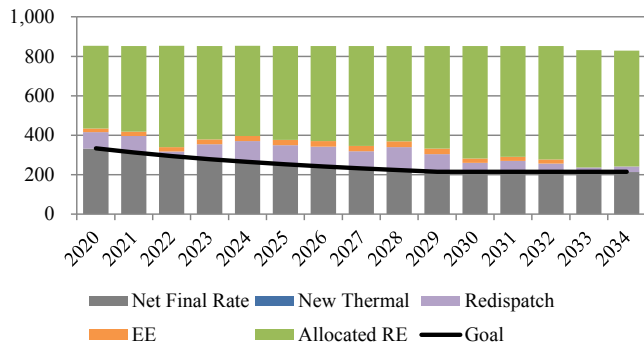

PacifiCorp's Share of AZ Compliance Profile (lb/MWh)

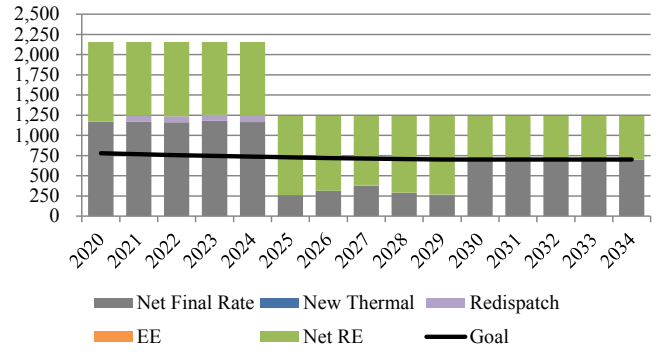

PacifiCorp's Share of MT Compliance Profile (lb/MWh)

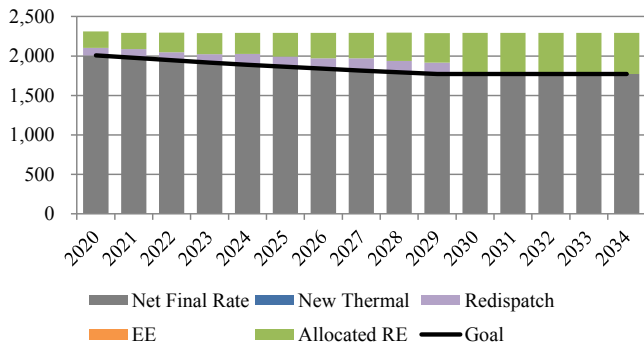

PacifiCorp's Share of CO Compliance Profile (lb/MWh)

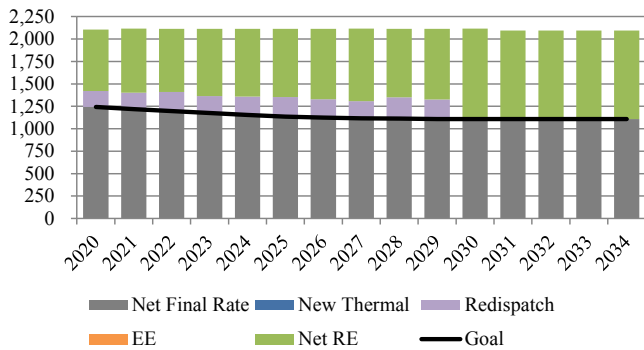

CASE ASSUMPTIONS

Description

Case C03-1 produces a portfolio that meets PacifiCorp’s share of state 111(d) emission rate goals in all states in which PacifiCorp owns fossil generation. The compliance strategy applied to this case relies on flexible allocation of renewable energy and energy efficiency, increased energy efficiency acquisition, and re-dispatch of fossil generation. New renewable resources are added after re-dispatch of fossil generation, as required. For planning purposes, this case assumes one of two different Regional Haze compliance scenarios reflecting potential inter-temporal and fleet trade-off compliance outcomes.

Federal CO₂ Policy/Price Signal

C03-1 reflects EPA’s proposed 111(d) rule with no additional CO₂ price signal. The table below summarizes the interim emission rate goal and the final emission rate target by state assumed to apply to PacifiCorp’s system.

State	Interim Goal (Avg. 2020-2029) (lb/MWh)	Final Target (2030 & Beyond) (lb/MWh)
WY	1,808	1,714
UT*	1,378	1,322
OR	407	372
WA	264	215
MT	1,882	1,771
CO	1,159	1,108
AZ	753	702

*EPA’s calculation of the target for UT treated PacifiCorp’s Lakeside 2 NGCC plant as an existing resource. The emission rate assumed for UT assumes Lake Side 2 is correctly classified as “under construction”.

The 111(d) compliance strategy implemented for this case is summarized as follows:

- Flexible allocation of system renewable resources and flexible allocation of cumulative energy efficiency savings beginning 2017 from ID and CA, where PacifiCorp does not own fossil generation.
- Cumulative selection of energy efficiency beginning 2017 up to 1.5% of retail sales.
- New NGCC generation in WY and UT (new NGCC resources are not allowed in OR, WA, and ID).
- Re-dispatch of existing fossil generation, as required.
- Addition of new renewable resources, as required.

Forward Price Curve

Case C03-1 gas and power prices reflect medium natural gas prices and regional compliance with EPA’s proposed 111(d) rule as implemented in the Company’s September 2014 official forward price curve (OFPC).

Nominal Average Annual Henry Hub Gas Prices

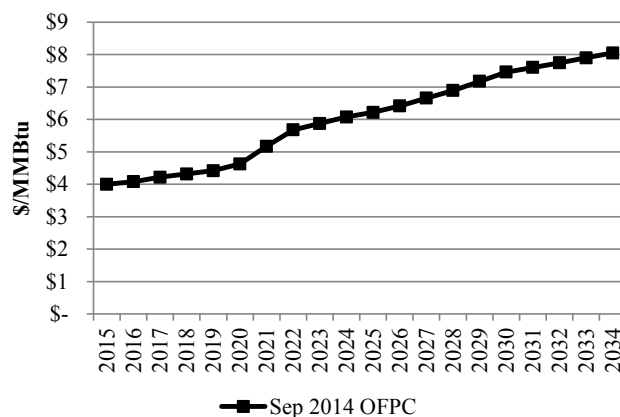

Nominal Average Annual Power Prices (Flat)

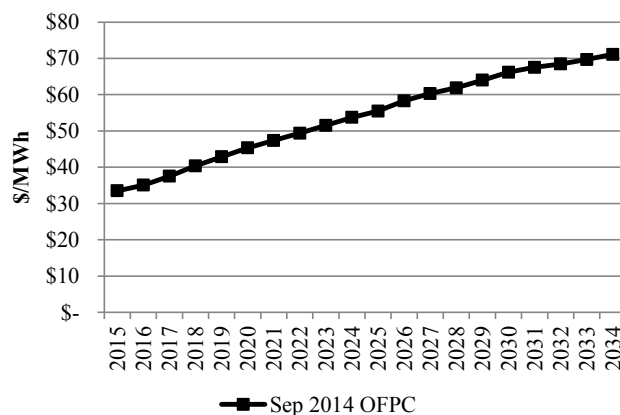

Regional Haze

Case C03-1 reflects Regional Haze Scenario 1, which assumes inter-temporal and fleet trade-off Regional Haze compliance outcomes as shown in the table below. This scenario is for planning purposes recognizing that agency, regulator, and joint owner perspectives on acceptability have not been determined.

Coal Unit	Description
Carbon 1	Shut Down Apr 2015
Carbon 2	Shut Down Apr 2015
Cholla 4	Conversion by Jun 2025
Colstrip 3	SCR by Dec 2023
Colstrip 4	SCR by Dec 2022
Craig 1	SCR by Aug 2021
Craig 2	SCR by Jan 2018
Dave Johnston 1	Shut Down Mar 2019
Dave Johnston 2	Shut Down Dec 2027
Dave Johnston 3	Shut Down Dec 2027
Dave Johnston 4	Shut Down Dec 2032
Hayden 1	SCR by Jun 2015
Hayden 2	SCR by Jun 2016
Hunter 1	SCR by Dec 2021
Hunter 2	Shut Down by Dec 2032
Hunter 3	SCR by Dec 2024
Huntington 1	Shut Down by Dec 2036

Case: C03-1

Coal Unit	Description
Huntington 2	Shut Down by Dec 2021
Jim Bridger 1	Shut Down by Dec 2023
Jim Bridger 2	Shut Down by Dec 2032
Jim Bridger 3	SCR by Dec 2015
Jim Bridger 4	SCR by Dec 2016
Naughton 1	Shut Down by Dec 2029
Naughton 2	Shut Down by Dec 2029
Naughton 3	Conversion by Jun 2018; Shut Down by Dec 2029
Wyodak	Shut Down by Dec 2039

*SCR = selective catalytic reduction

Federal Tax Incentives

- PTCs expire end of 2013
- ITC of 30% expire end of 2016, thereafter it continues in perpetuity at 10%.

Load Forecast

The figure below shows the medium system coincident peak load forecast applicable to this case before accounting for any potential contribution from DSM or distributed generation resources.

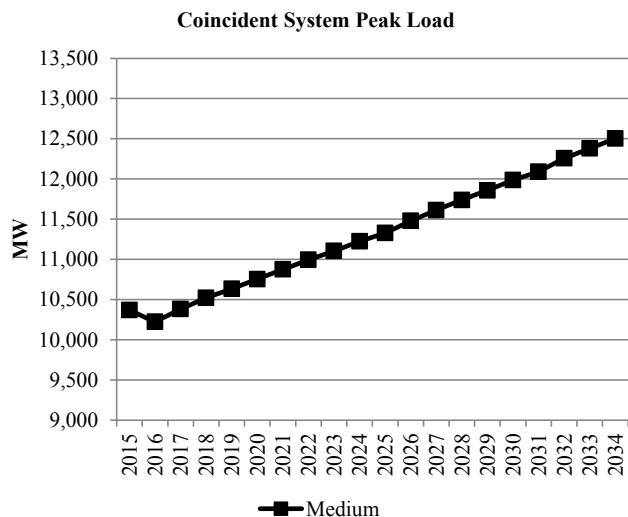

Energy Efficiency (Class 2 DSM)

This case uses base supply curves with economic resource selections up to the achievable potential. Additional energy efficiency beyond economic selections, up to 1.5% of retail sales, is forced into the resource portfolio. Class 2 resources that are not selected or forced in any given year are not available for selection in future years. Achievable potential by state and year are summarized in the following figure.

Class 2 DSM Cumulative Achievable Potential

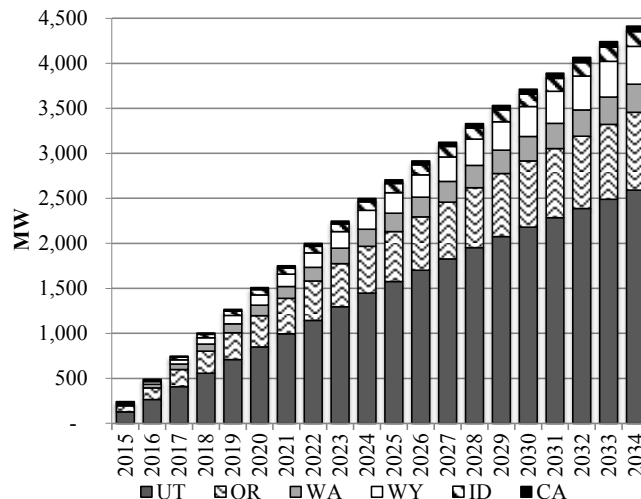

Distributed Generation

Base case distributed generation penetration is assumed in all states. Distributed generation by state and year are summarized below.

Distributed Generation - Base Penetration Case

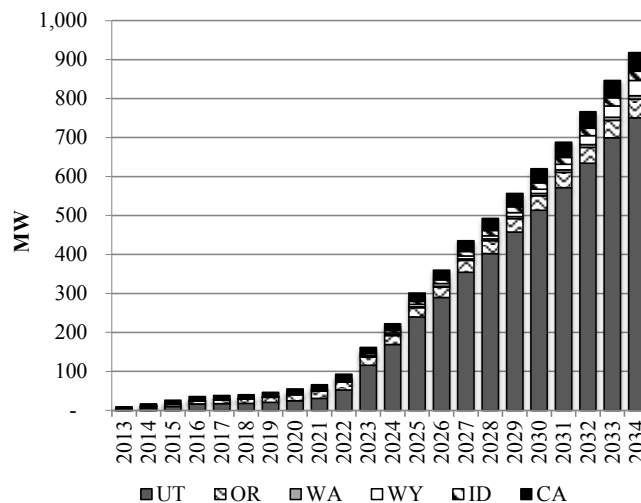

PORTFOLIO SUMMARY

System Optimizer PVRR (\$m)

System Cost without Transmission Upgrades	\$28,835
Transmission Integration	\$48
Transmission Reinforcement	\$6
Total Cost	\$28,889

Case: C03-1

Resource Portfolio

Cumulative changes to the resource portfolio (new resource additions and resource retirements), represented as nameplate capacity, are summarized in the figure below.

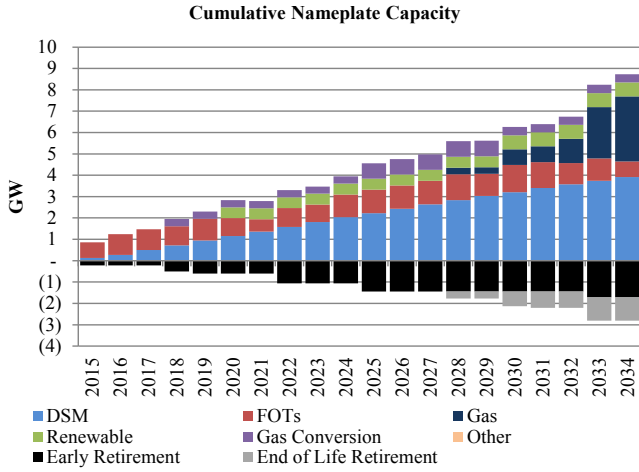

System CO₂ Emissions (System Optimizer)

System CO₂ emissions from System Optimizer are shown alongside those from Cases C01-R and C01-1 in the figure below.

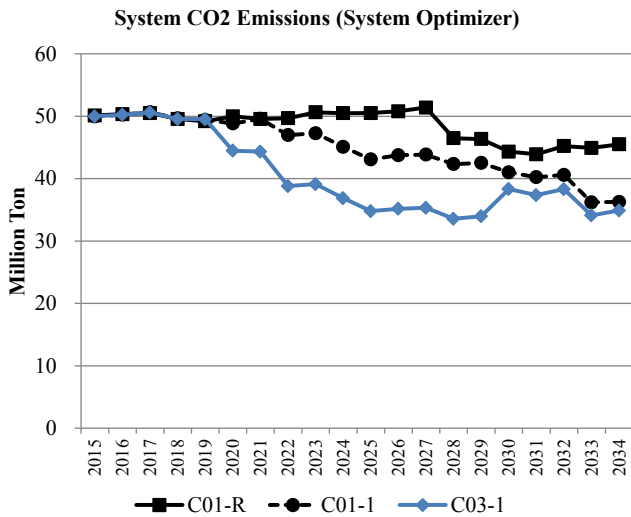

111(d) Compliance Profiles

The following figures summarize how compliance with state emission rate goals is achieved. The sum of each stacked bar represents the fossil emission rate. The net final rate represents the fossil rate after accounting for the emission rate impacts of new thermal (new NGCC units or nuclear, as applicable), re-dispatch of fossil units, energy efficiency (EE), and allocated renewable energy (RE).

PacifiCorp Share of WY Compliance Profile (lb/MWh)

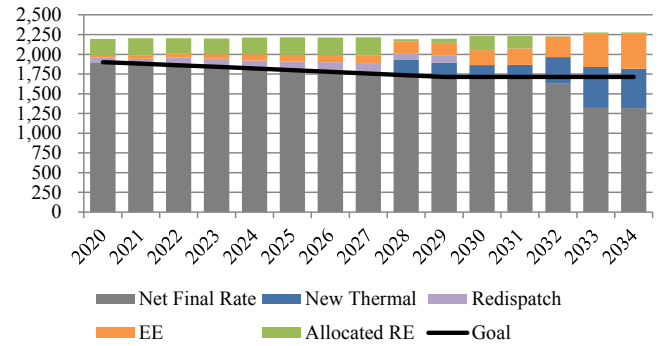

PacifiCorp Share of UT Compliance Profile (lb/MWh)

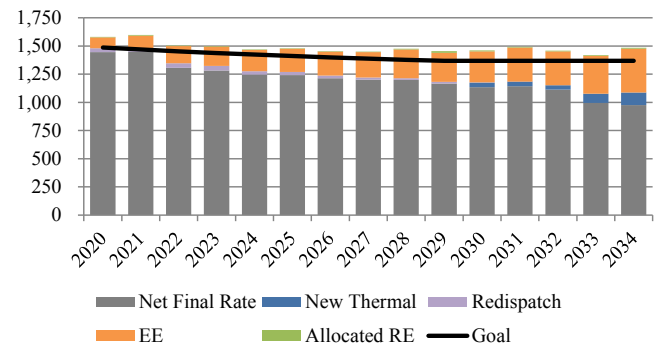

PacifiCorp Share of OR Compliance Profile (lb/MWh)

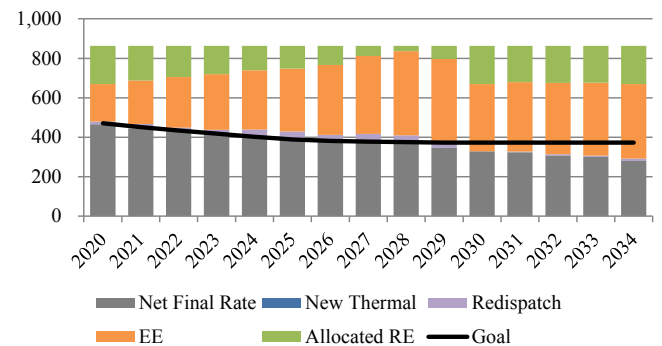

PacifiCorp Share of WA Compliance Profile (lb/MWh)

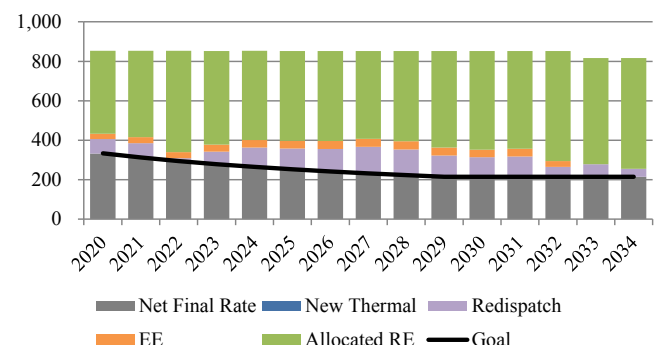

Case: C03-1

PacifiCorp's Share of MT Compliance Profile (lb/MWh)

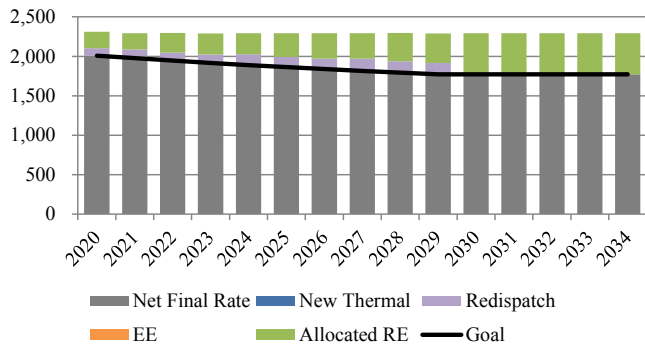

PacifiCorp's Share of CO Compliance Profile (lb/MWh)

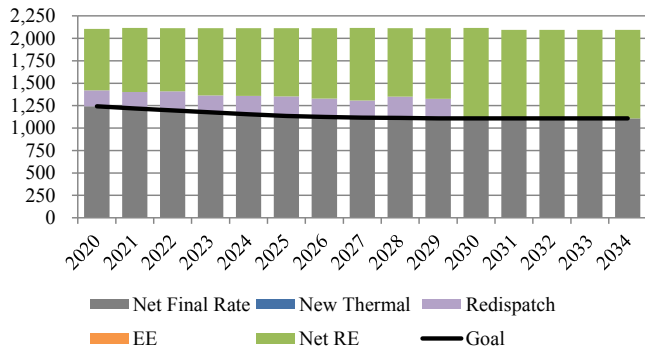

PacifiCorp's Share of AZ Compliance Profile (lb/MWh)

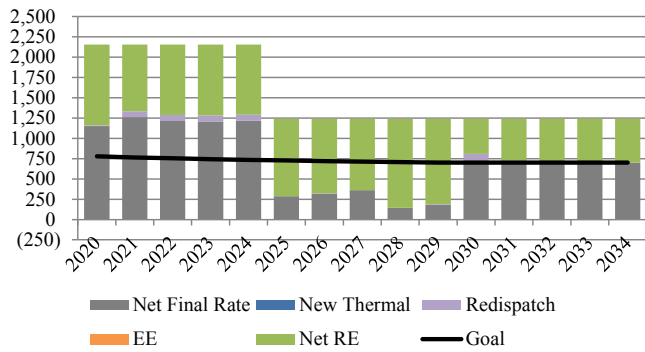

CASE ASSUMPTIONS

Description

Case C03-2 produces a portfolio that meets PacifiCorp’s share of state 111(d) emission rate goals in all states in which PacifiCorp owns fossil generation. The compliance strategy applied to this case relies on flexible allocation of renewable energy and energy efficiency, increased energy efficiency acquisition, and re-dispatch of fossil generation. New renewable resources are added after re-dispatch of fossil generation, as required. For planning purposes, this case assumes one of two different Regional Haze compliance scenarios reflecting potential inter-temporal and fleet trade-off compliance outcomes.

Federal CO₂ Policy/Price Signal

C03-2 reflects EPA’s proposed 111(d) rule with no additional CO₂ price signal. The table below summarizes the interim emission rate goal and the final emission rate target by state assumed to apply to PacifiCorp’s system.

State	Interim Goal (Avg. 2020-2029) (lb/MWh)	Final Target (2030 & Beyond) (lb/MWh)
WY	1,808	1,714
UT*	1,378	1,322
OR	407	372
WA	264	215
MT	1,882	1,771
CO	1,159	1,108
AZ	753	702

*EPA’s calculation of the target for UT treated PacifiCorp’s Lakeside 2 NGCC plant as an existing resource. The emission rate assumed for UT assumes Lake Side 2 is correctly classified as “under construction”.

The 111(d) compliance strategy implemented for this case is summarized as follows:

- Flexible allocation of system renewable resources and flexible allocation of cumulative energy efficiency savings beginning 2017 from ID and CA, where PacifiCorp does not own fossil generation.
- Cumulative selection of energy efficiency beginning 2017 up to 1.5% of retail sales.
- New NGCC generation in WY and UT (new NGCC resources are not allowed in OR, WA, and ID).
- Re-dispatch of existing fossil generation, as required.
- Addition of new renewable resources, as required.

Forward Price Curve

Case C03-2 gas and power prices reflect medium natural gas prices and regional compliance with EPA’s proposed 111(d) rule as implemented in the Company’s September 2014 official forward price curve (OFPC).

Nominal Average Annual Henry Hub Gas Prices

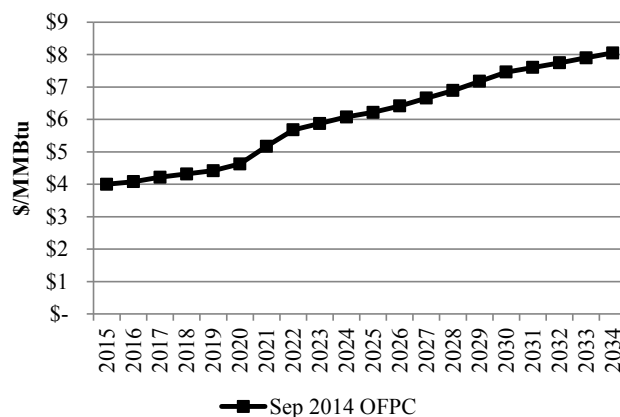

Nominal Average Annual Power Prices (Flat)

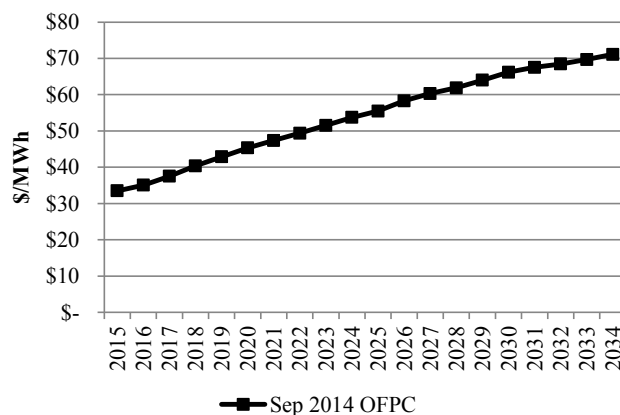

Regional Haze

Case C03-2 reflects Regional Haze Scenario 2, which assumes inter-temporal and fleet trade-off Regional Haze compliance outcomes as shown in the table below. This scenario is for planning purposes recognizing that agency, regulator, and joint owner perspectives on acceptability have not been determined.

Coal Unit	Description
Carbon 1	Shut Down Apr 2015
Carbon 2	Shut Down Apr 2015
Cholla 4	Conversion by Jun 2025
Colstrip 3	SCR by Dec 2023
Colstrip 4	SCR by Dec 2022
Craig 1	SCR by Aug 2021
Craig 2	SCR by Jan 2018
Dave Johnson 1	Shut Down Mar 2019
Dave Johnson 2	Shut Down Dec 2023
Dave Johnson 3	Shut Down Dec 2027
Dave Johnson 4	Shut Down Dec 2032
Hayden 1	SCR by Jun 2015
Hayden 2	SCR by Jun 2016
Hunter 1	SCR by Dec 2021
Hunter 2	Shut Down Dec 2024
Hunter 3	SCR by Dec 2024
Huntington 1	Shut Down Dec 2024
Huntington 2	Shut Down by Dec 2021

Case: C03-2

Coal Unit	Description
Jim Bridger 1	Shut Down by Dec 2023
Jim Bridger 2	Shut Down by Dec 2028
Jim Bridger 3	SCR by Dec 2015
Jim Bridger 4	SCR by Dec 2016
Naughton 1	Shut Down by Dec 2029
Naughton 2	Shut Down by Dec 2029
Naughton 3	Conversion by Jun 2018; Shut Down by Dec 2029
Wyodak	Shut Down by Dec 2032

*SCR = selective catalytic reduction

Federal Tax Incentives

- PTCs expire end of 2013
- ITC of 30% expire end of 2016, thereafter it continues in perpetuity at 10%.

Load Forecast

The figure below shows the medium system coincident peak load forecast applicable to this case before accounting for any potential contribution from DSM or distributed generation resources.

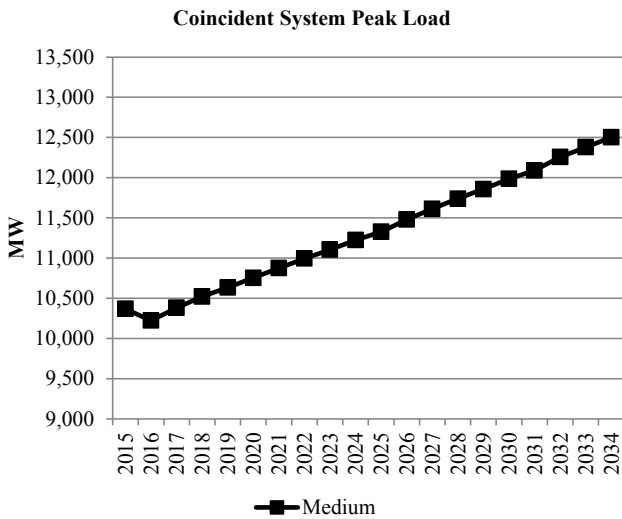

Energy Efficiency (Class 2 DSM)

This case uses base supply curves with economic resource selections up to the achievable potential. Additional energy efficiency beyond economic selections, up to 1.5% of retail sales, is forced into the resource portfolio. Class 2 resources that are not selected or forced in any given year are not available for selection in future years. Achievable potential by state and year are summarized in the following figure.

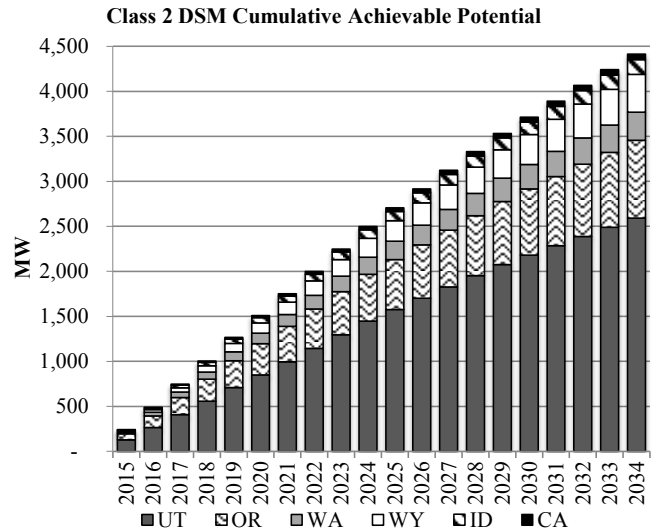

Distributed Generation

Base case distributed generation penetration is assumed in all states. Distributed generation by state and year are summarized below.

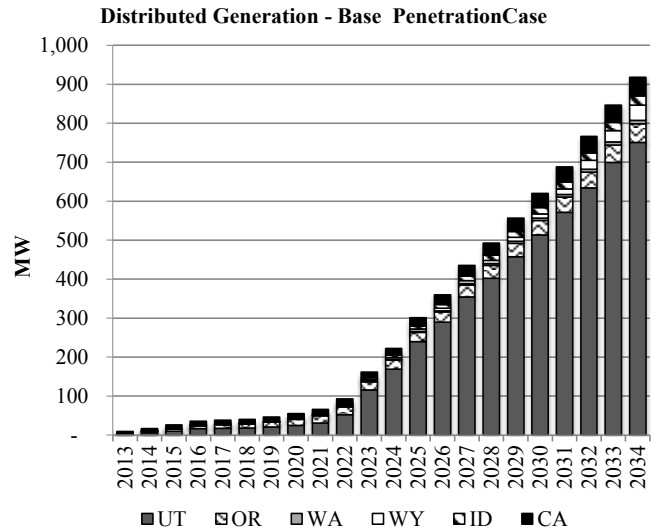

PORTFOLIO SUMMARY

System Optimizer PVRR (\$m)

System Cost without Transmission Upgrades	\$29,447
Transmission Integration	\$53
Transmission Reinforcement	\$10
Total Cost	\$29,509

Case: C03-2

Resource Portfolio

Cumulative changes to the resource portfolio (new resource additions and resource retirements), represented as nameplate capacity, are summarized in the figure below.

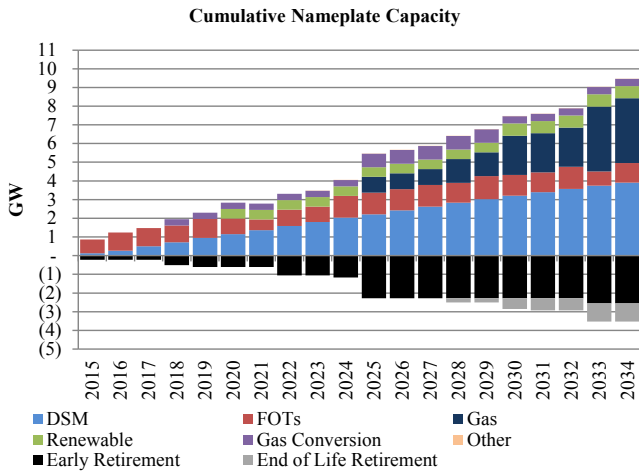

System CO₂ Emissions (System Optimizer)

System CO₂ emissions from System Optimizer are shown alongside those from Cases C01-R and C01-2 in the figure below.

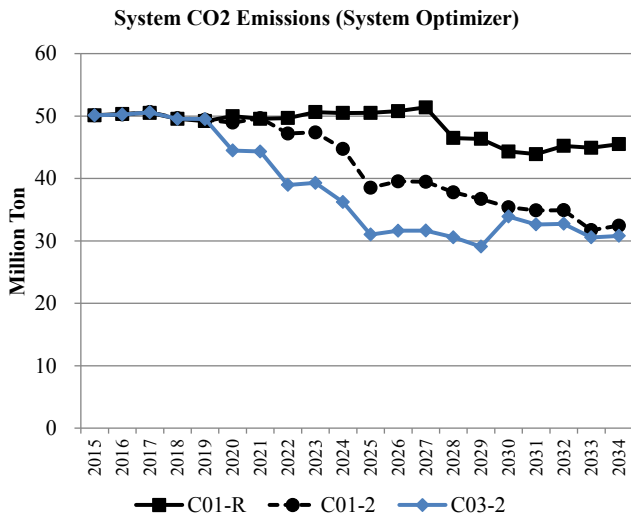

111(d) Compliance Profiles

The following figures summarize how compliance with state emission rate goals is achieved. The sum of each stacked bar represents the fossil emission rate. The net final rate represents the fossil rate after accounting for the emission rate impacts of new thermal (new NGCC units or nuclear, as applicable), re-dispatch of fossil units, energy efficiency (EE), and allocated renewable energy (RE).

PacifiCorp Share of WY Compliance Profile (lb/MWh)

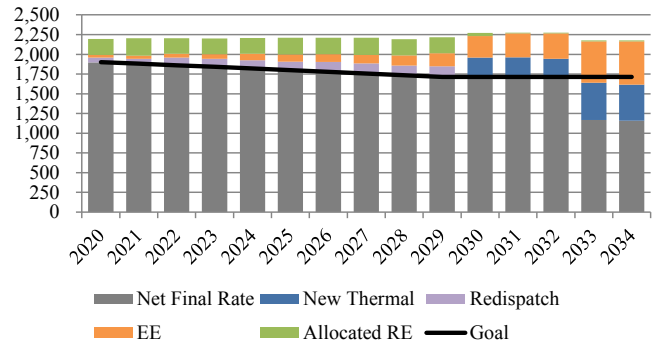

PacifiCorp Share of UT Compliance Profile (lb/MWh)

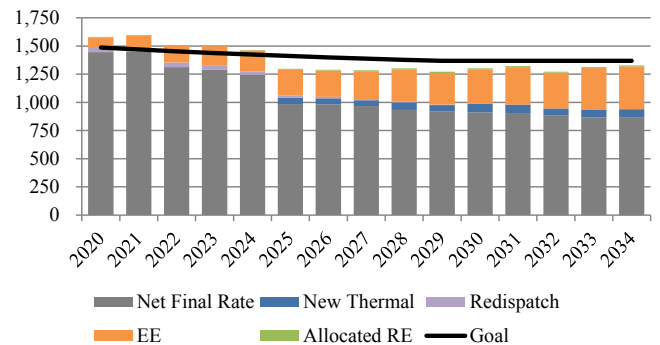

PacifiCorp Share of OR Compliance Profile (lb/MWh)

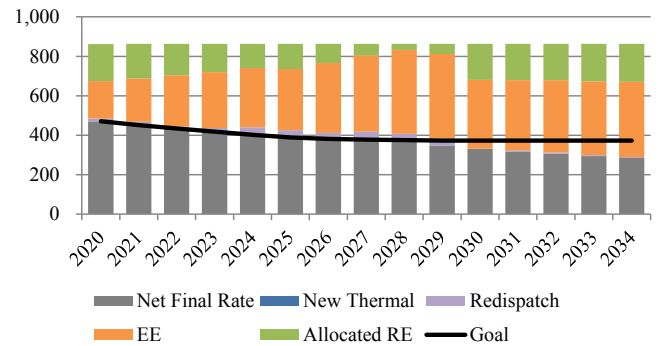

PacifiCorp Share of WA Compliance Profile (lb/MWh)

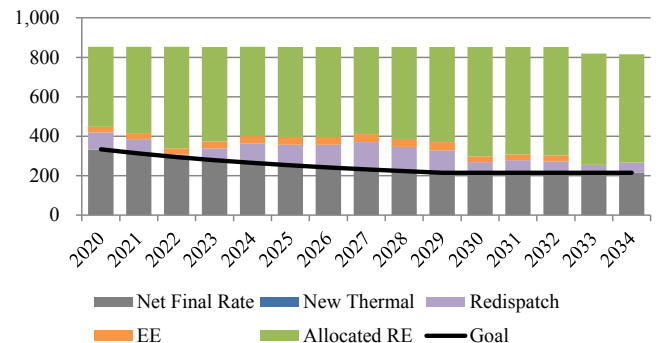

PacifiCorp's Share of MT Compliance Profile (lb/MWh)

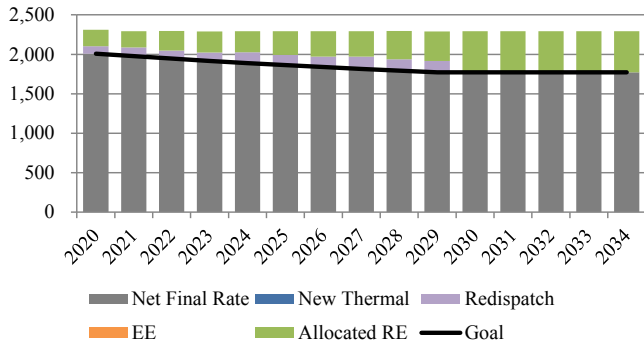

PacifiCorp's Share of CO Compliance Profile (lb/MWh)

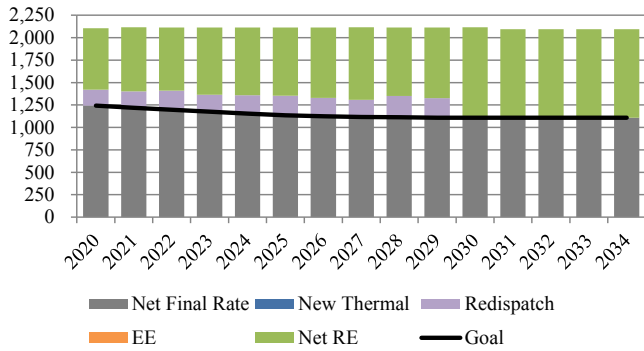

PacifiCorp's Share of AZ Compliance Profile (lb/MWh)

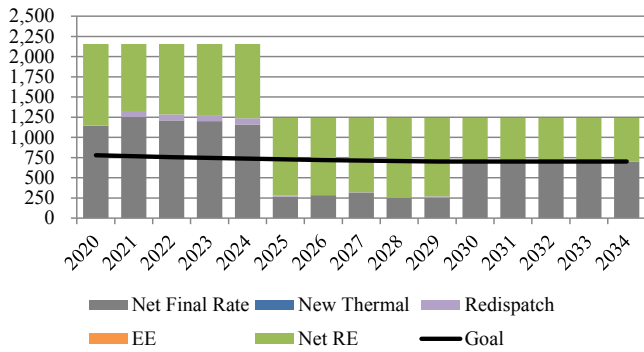

CASE ASSUMPTIONS

Description

Case C04-1 produces a portfolio that meets PacifiCorp’s share of state 111(d) emission rate goals in all states in which PacifiCorp owns fossil generation. The compliance strategy applied to this case relies on flexible allocation of renewable energy and energy efficiency, increased energy efficiency acquisition, and renewable resource acquisition. Re-dispatch of fossil generation is implemented after adding new renewable resources, as required. For planning purposes, this case assumes one of two different Regional Haze compliance scenarios reflecting potential inter-temporal and fleet trade-off compliance outcomes.

Federal CO₂ Policy/Price Signal

C04-1 reflects EPA’s proposed 111(d) rule with no additional CO₂ price signal. The table below summarizes the interim emission rate goal and the final emission rate target by state assumed to apply to PacifiCorp’s system.

State	Interim Goal (Avg. 2020-2029) (lb/MWh)	Final Target (2030 & Beyond) (lb/MWh)
WY	1,808	1,714
UT*	1,378	1,322
OR	407	372
WA	264	215
MT	1,882	1,771
CO	1,159	1,108
AZ	753	702

*EPA’s calculation of the target for UT treated PacifiCorp’s Lakeside 2 NGCC plant as an existing resource. The emission rate assumed for UT assumes Lake Side 2 is correctly classified as “under construction”.

The 111(d) compliance strategy implemented for this case is summarized as follows:

- Flexible allocation of system renewable resources and flexible allocation of cumulative energy efficiency savings beginning 2017 from ID and CA, where PacifiCorp does not own fossil generation.
- Cumulative selection of energy efficiency beginning 2017 up to 1.5% of retail sales.
- New NGCC generation in WY and UT (new NGCC resources are not allowed in OR, WA, and ID).
- Addition of new renewable resources, as required.
- Re-dispatch of existing fossil generation, as required.

Forward Price Curve

Case C04-1 gas and power prices reflect medium natural gas prices and regional compliance with EPA’s proposed 111(d) rule as implemented in the Company’s September 2014 official forward price curve (OFPC).

Nominal Average Annual Henry Hub Gas Prices

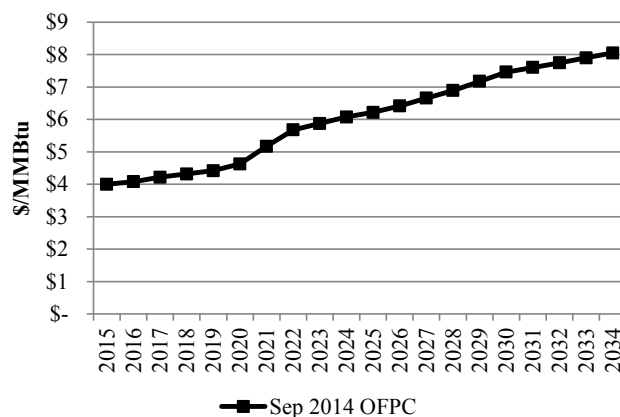

Nominal Average Annual Power Prices (Flat)

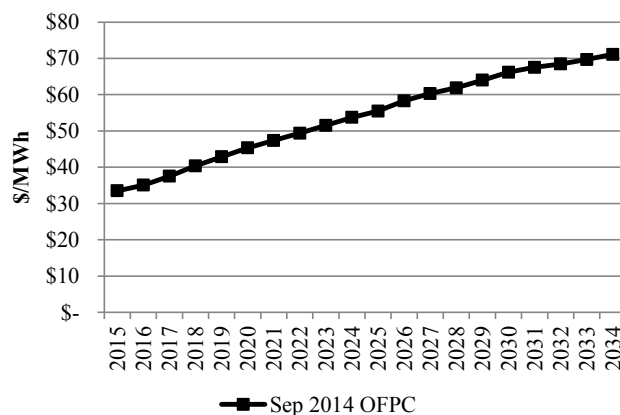

Regional Haze

Case C04-1 reflects Regional Haze Scenario 1, which assumes inter-temporal and fleet trade-off Regional Haze compliance outcomes as shown in the table below. This scenario is for planning purposes recognizing that agency, regulator, and joint owner perspectives on acceptability have not been determined.

Coal Unit	Description
Carbon 1	Shut Down Apr 2015
Carbon 2	Shut Down Apr 2015
Cholla 4	Conversion by Jun 2025
Colstrip 3	SCR by Dec 2023
Colstrip 4	SCR by Dec 2022
Craig 1	SCR by Aug 2021
Craig 2	SCR by Jan 2018
Dave Johnston 1	Shut Down Mar 2019
Dave Johnston 2	Shut Down Dec 2027
Dave Johnston 3	Shut Down Dec 2027
Dave Johnston 4	Shut Down Dec 2032
Hayden 1	SCR by Jun 2015
Hayden 2	SCR by Jun 2016
Hunter 1	SCR by Dec 2021
Hunter 2	Shut Down by Dec 2032
Hunter 3	SCR by Dec 2024
Huntington 1	Shut Down by Dec 2036

Case: C04-1

Coal Unit	Description
Huntington 2	Shut Down by Dec 2021
Jim Bridger 1	Shut Down by Dec 2023
Jim Bridger 2	Shut Down by Dec 2032
Jim Bridger 3	SCR by Dec 2015
Jim Bridger 4	SCR by Dec 2016
Naughton 1	Shut Down by Dec 2029
Naughton 2	Shut Down by Dec 2029
Naughton 3	Conversion by Jun 2018; Shut Down by Dec 2029
Wyodak	Shut Down by Dec 2039

*SCR = selective catalytic reduction

Federal Tax Incentives

- PTCs expire end of 2013
- ITC of 30% expire end of 2016, thereafter it continues in perpetuity at 10%.

Load Forecast

The figure below shows the medium system coincident peak load forecast applicable to this case before accounting for any potential contribution from DSM or distributed generation resources.

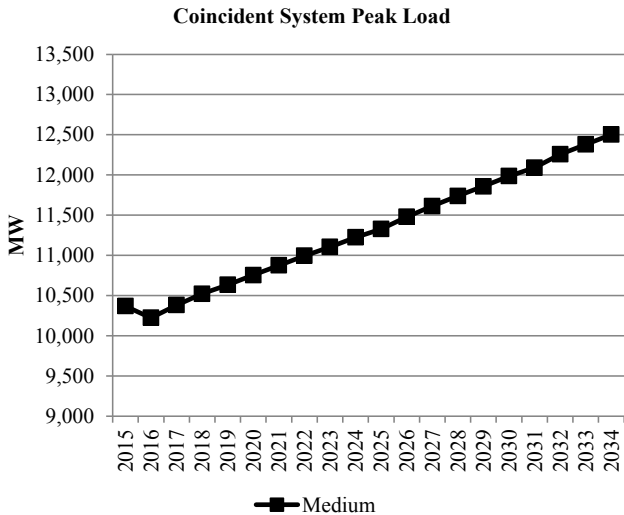

Energy Efficiency (Class 2 DSM)

This case uses base supply curves with economic resource selections up to the achievable potential. Additional energy efficiency beyond economic selections, up to 1.5% of retail sales, is forced into the resource portfolio. Class 2 resources that are not selected or forced in any given year are not available for selection in future years. Achievable potential by state and year are summarized in the following figure.

Class 2 DSM Cumulative Achievable Potential

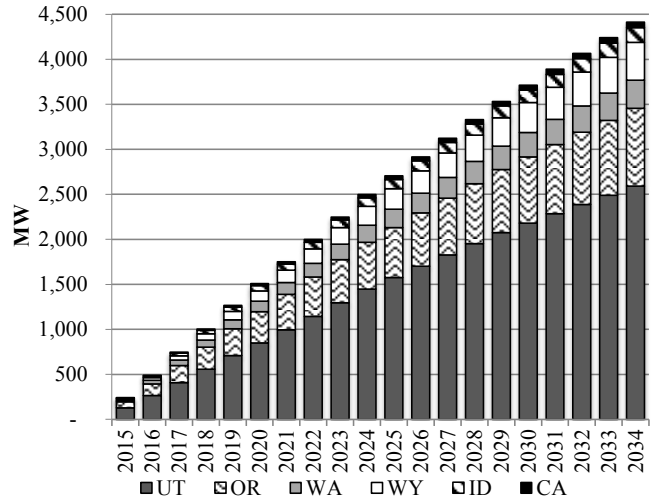

Distributed Generation

Base case distributed generation penetration is assumed in all states. Distributed generation by state and year are summarized below.

Distributed Generation - Base Penetration Case

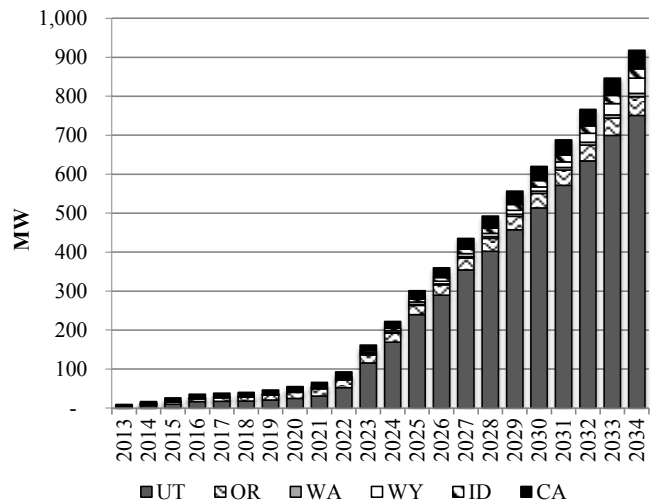

PORTFOLIO SUMMARY

System Optimizer PVRR (\$m)

System Cost without Transmission Upgrades	\$29,111
Transmission Integration	\$193
Transmission Reinforcement	\$6
Total Cost	\$29,310

Case: C04-1

Resource Portfolio

Cumulative changes to the resource portfolio (new resource additions and resource retirements), represented as nameplate capacity, are summarized in the figure below.

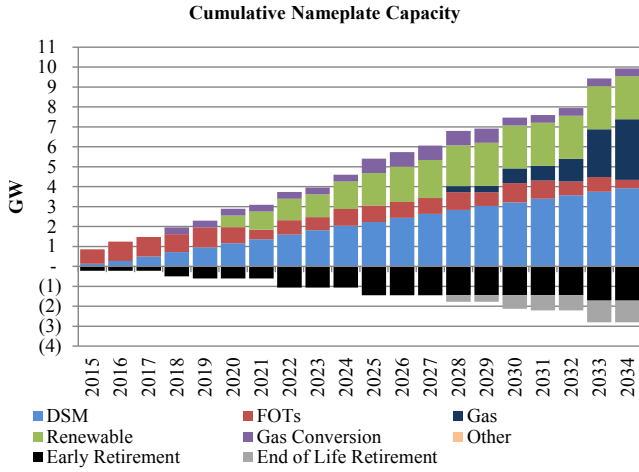

System CO₂ Emissions (System Optimizer)

System CO₂ emissions from System Optimizer are shown alongside those from Cases C01-R and C01-1 in the figure below.

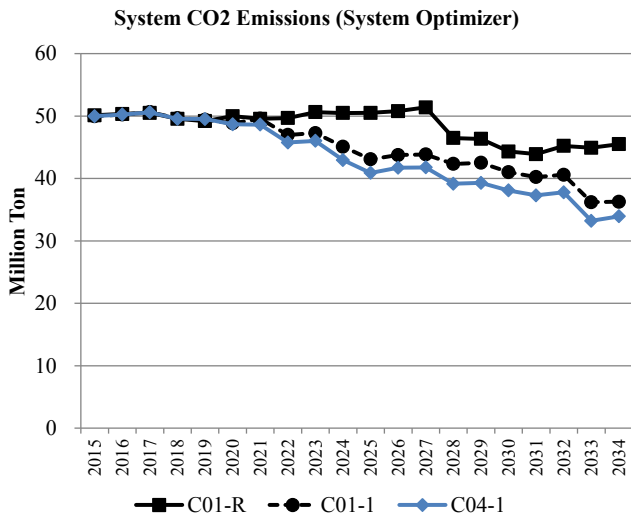

111(d) Compliance Profiles

The following figures summarize how compliance with state emission rate goals is achieved. The sum of each stacked bar represents the fossil emission rate. The net final rate represents the fossil rate after accounting for the emission rate impacts of new thermal (new NGCC units or nuclear, as applicable), re-dispatch of fossil units, energy efficiency (EE), and allocated renewable energy (RE).

PacifiCorp Share of WY Compliance Profile (lb/MWh)

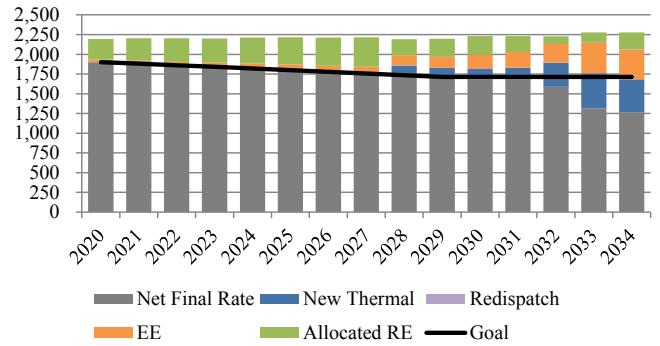

PacifiCorp Share of UT Compliance Profile (lb/MWh)

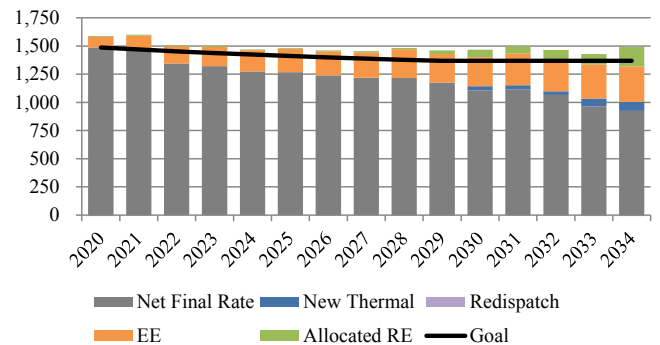

PacifiCorp Share of OR Compliance Profile (lb/MWh)

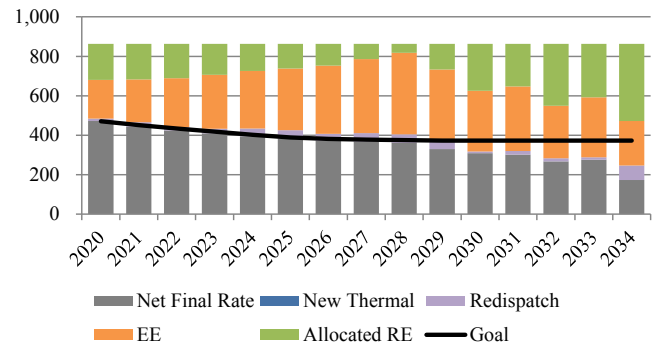

PacifiCorp Share of WA Compliance Profile (lb/MWh)

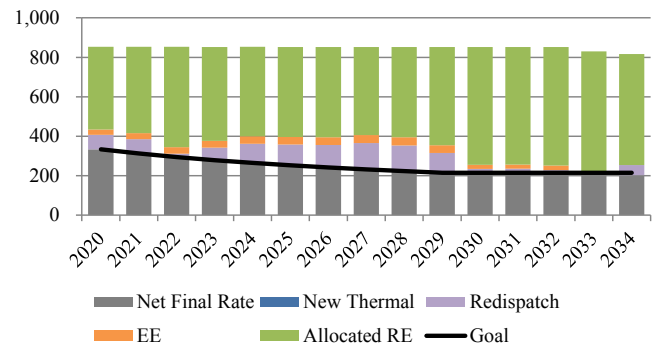

Case: C04-1

PacifiCorp's Share of MT Compliance Profile (lb/MWh)

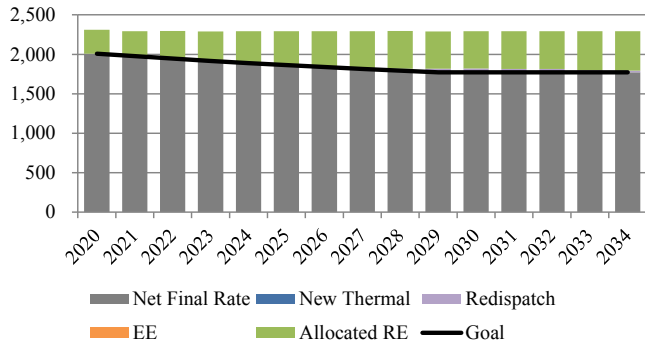

PacifiCorp's Share of CO Compliance Profile (lb/MWh)

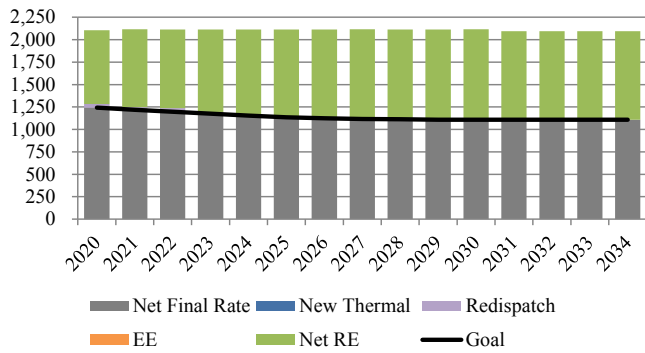

PacifiCorp's Share of AZ Compliance Profile (lb/MWh)

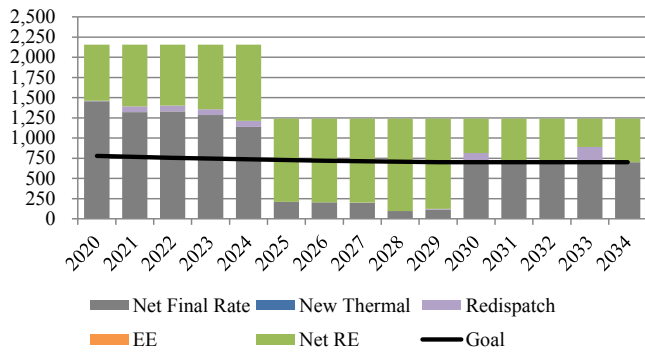

CASE ASSUMPTIONS

Description

Case C04-2 produces a portfolio that meets PacifiCorp’s share of state 111(d) emission rate goals in all states in which PacifiCorp owns fossil generation. The compliance strategy applied to this case relies on flexible allocation of renewable energy and energy efficiency, increased energy efficiency acquisition, and renewable resource acquisition. Re-dispatch of fossil generation is implemented after adding new renewable resources, as required. For planning purposes, this case assumes one of two different Regional Haze compliance scenarios reflecting potential inter-temporal and fleet trade-off compliance outcomes.

Federal CO₂ Policy/Price Signal

C04-2 reflects EPA’s proposed 111(d) rule with no additional CO₂ price signal. The table below summarizes the interim emission rate goal and the final emission rate target by state assumed to apply to PacifiCorp’s system.

State	Interim Goal (Avg. 2020-2029) (lb/MWh)	Final Target (2030 & Beyond) (lb/MWh)
WY	1,808	1,714
UT*	1,378	1,322
OR	407	372
WA	264	215
MT	1,882	1,771
CO	1,159	1,108
AZ	753	702

*EPA’s calculation of the target for UT treated PacifiCorp’s Lakeside 2 NGCC plant as an existing resource. The emission rate assumed for UT assumes Lake Side 2 is correctly classified as “under construction”.

The 111(d) compliance strategy implemented for this case is summarized as follows:

- Flexible allocation of system renewable resources and flexible allocation of cumulative energy efficiency savings beginning 2017 from ID and CA, where PacifiCorp does not own fossil generation.
- Cumulative selection of energy efficiency beginning 2017 up to 1.5% of retail sales.
- New NGCC generation in WY and UT (new NGCC resources are not allowed in OR, WA, and ID).
- Addition of new renewable resources, as required.
- Re-dispatch of existing fossil generation, as required.

Forward Price Curve

Case C04-2 gas and power prices reflect medium natural gas prices and regional compliance with EPA’s proposed 111(d) rule as implemented in the Company’s September 2014 official forward price curve (OFPC).

Nominal Average Annual Henry Hub Gas Prices

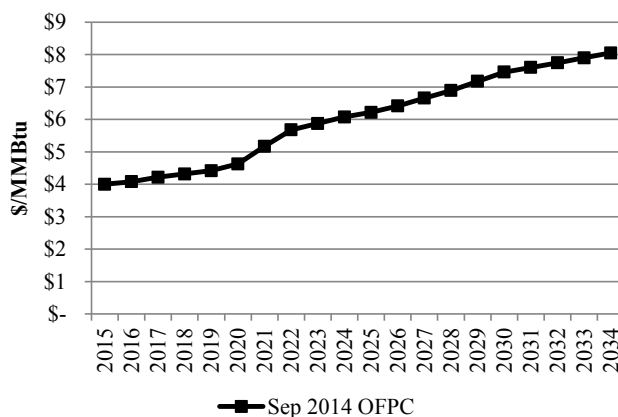

Nominal Average Annual Power Prices (Flat)

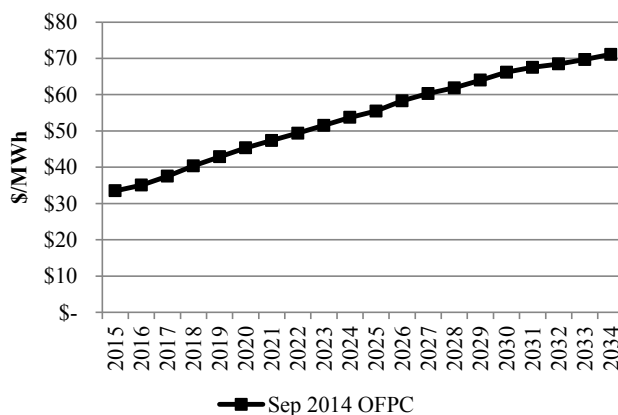

Regional Haze

Case C04-2 reflects Regional Haze Scenario 2, which assumes inter-temporal and fleet trade-off Regional Haze compliance outcomes as shown in the table below. This scenario is for planning purposes recognizing that agency, regulator, and joint owner perspectives on acceptability have not been determined.

Coal Unit	Description
Carbon 1	Shut Down Apr 2015
Carbon 2	Shut Down Apr 2015
Cholla 4	Conversion by Jun 2025
Colstrip 3	SCR by Dec 2023
Colstrip 4	SCR by Dec 2022
Craig 1	SCR by Aug 2021
Craig 2	SCR by Jan 2018
Dave Johnson 1	Shut Down Mar 2019
Dave Johnson 2	Shut Down Dec 2023
Dave Johnson 3	Shut Down Dec 2027
Dave Johnson 4	Shut Down Dec 2032
Hayden 1	SCR by Jun 2015
Hayden 2	SCR by Jun 2016
Hunter 1	SCR by Dec 2021
Hunter 2	Shut Down Dec 2024
Hunter 3	SCR by Dec 2024
Huntington 1	Shut Down Dec 2024
Huntington 2	Shut Down by Dec 2021

Case: C04-2

Coal Unit	Description
Jim Bridger 1	Shut Down by Dec 2023
Jim Bridger 2	Shut Down by Dec 2028
Jim Bridger 3	SCR by Dec 2015
Jim Bridger 4	SCR by Dec 2016
Naughton 1	Shut Down by Dec 2029
Naughton 2	Shut Down by Dec 2029
Naughton 3	Conversion by Jun 2018; Shut Down by Dec 2029
Wyodak	Shut Down by Dec 2032

*SCR = selective catalytic reduction

Federal Tax Incentives

- PTCs expire end of 2013
- ITC of 30% expire end of 2016, thereafter it continues in perpetuity at 10%.

Load Forecast

The figure below shows the medium system coincident peak load forecast applicable to this case before accounting for any potential contribution from DSM or distributed generation resources.

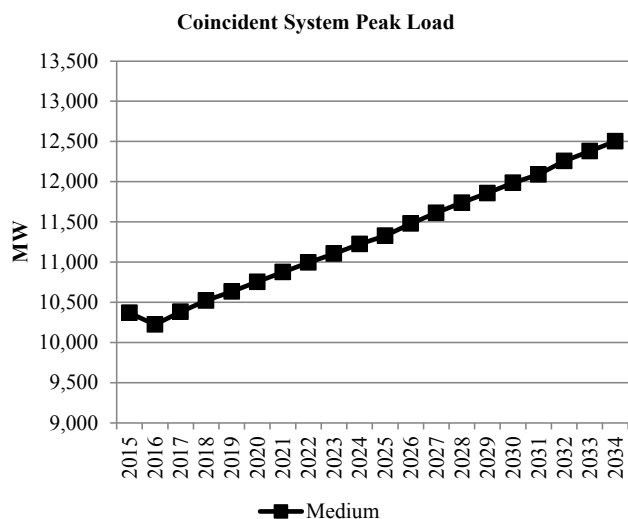

Energy Efficiency (Class 2 DSM)

This case uses base supply curves with economic resource selections up to the achievable potential. Additional energy efficiency beyond economic selections, up to 1.5% of retail sales, is forced into the resource portfolio. Class 2 resources that are not selected or forced in any given year are not available for selection in future years. Achievable potential by state and year are summarized in the following figure.

Class 2 DSM Cumulative Achievable Potential

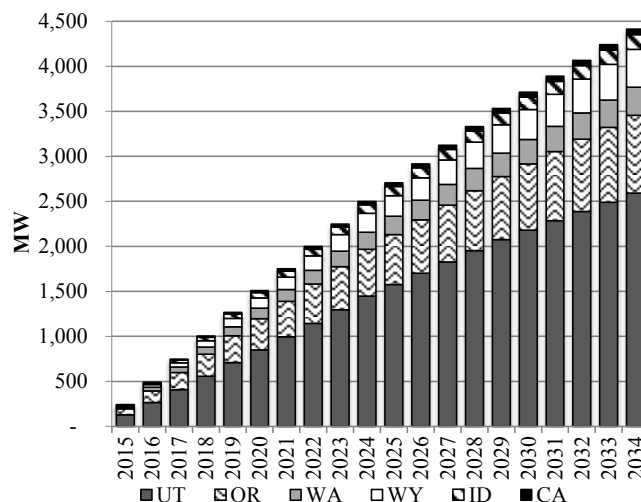

Distributed Generation

Base case distributed generation penetration is assumed in all states. Distributed generation by state and year are summarized below.

Distributed Generation - Base Penetration Case

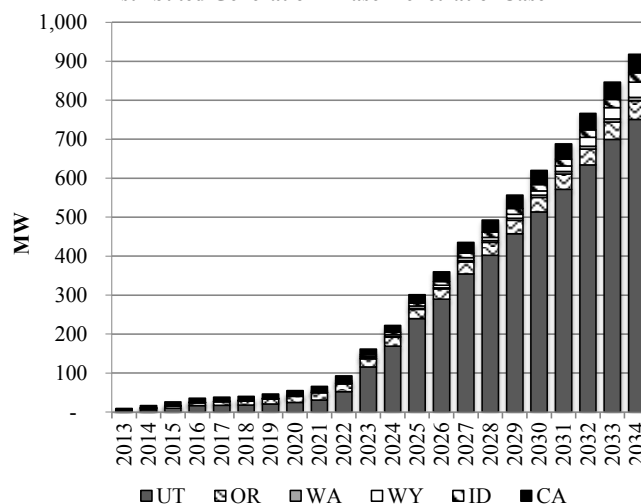

PORTFOLIO SUMMARY

System Optimizer PVRR (\$m)

System Cost without Transmission Upgrades	\$29,706
Transmission Integration	\$198
Transmission Reinforcement	\$10
Total Cost	\$29,913

Resource Portfolio

Cumulative changes to the resource portfolio (new resource additions and resource retirements), represented as nameplate capacity, are summarized in the following figure.

Case: C04-2

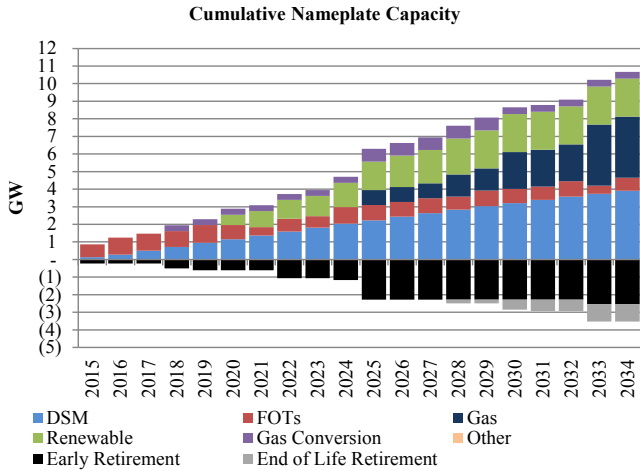

System CO₂ Emissions (System Optimizer)

System CO₂ emissions from System Optimizer are shown alongside those from Cases C01-R and C01-2 in the figure below.

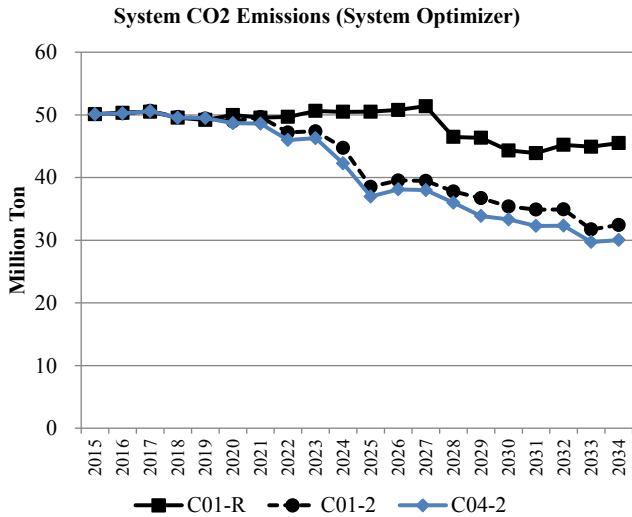

111(d) Compliance Profiles

The following figures summarize how compliance with state emission rate goals is achieved. The sum of each stacked bar represents the fossil emission rate. The net final rate represents the fossil rate after accounting for the emission rate impacts of new thermal (new NGCC units or nuclear, as applicable), re-dispatch of fossil units, energy efficiency (EE), and allocated renewable energy (RE).

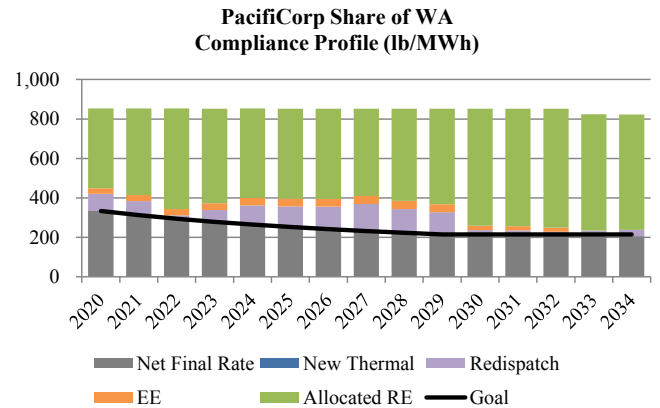
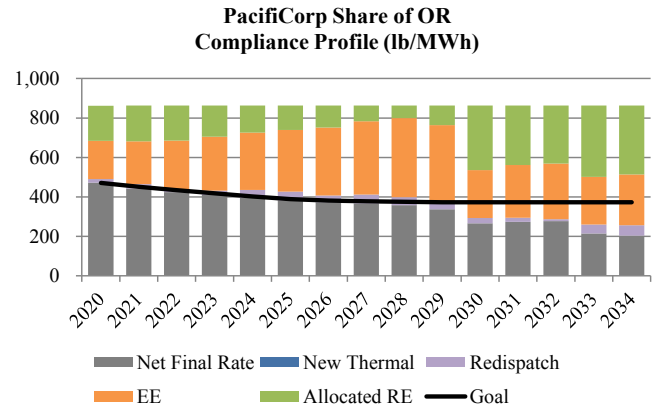
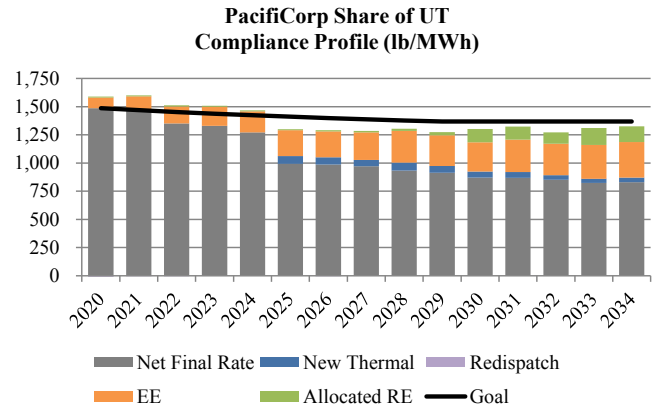
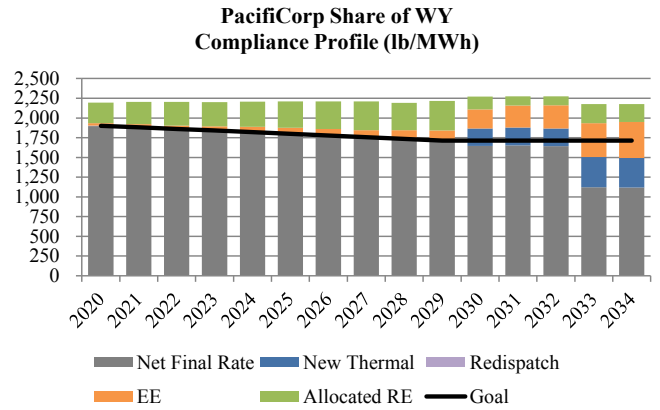

CASE ASSUMPTIONS

Description

Case C05-1 produces a portfolio that meets PacifiCorp’s share of state 111(d) emission rate goals in all states in which PacifiCorp has fossil generation and retail customers. The compliance strategy applied to this case relies on flexible allocation of renewable energy and energy efficiency while prioritizing re-dispatch of fossil generation to achieve incremental emission rate reductions as required. For planning purposes, this case assumes one of two different Regional Haze compliance scenarios reflecting potential inter-temporal and fleet trade-off compliance outcomes.

Federal CO₂ Policy/Price Signal

C05-1 reflects EPA’s proposed 111(d) rule with no additional CO₂ price signal. The table below summarizes the interim emission rate goal and the final emission rate target by state assumed to apply to PacifiCorp’s system.

State	Interim Goal (Avg. 2020-2029) (lb/MWh)	Final Target (2030 & Beyond) (lb/MWh)
WY	1,808	1,714
UT*	1,378	1,322
OR	407	372
WA	264	215

*EPA’s calculation of the target for UT treated PacifiCorp’s Lakeside 2 NGCC plant as an existing resource. The emission rate assumed for UT assumes Lake Side 2 is correctly classified as “under construction”.

The 111(d) compliance strategy implemented for this case is summarized as follows:

- Flexible allocation of system renewable resources and flexible allocation of cumulative energy efficiency savings beginning 2017 from ID and CA, where PacifiCorp does not own fossil generation.
- Cumulative cost-effective selection of energy efficiency beginning 2017.
- New NGCC generation in WY and UT (new NGCC resources are not allowed in OR, WA, and ID).
- Re-dispatch of existing fossil generation, as required.
- Addition of new renewable resources, as required.

Forward Price Curve

Case C05-1 gas and power prices reflect medium natural gas prices and regional compliance with EPA’s proposed 111(d) rule as implemented in the Company’s September 2014 official forward price curve (OFPC).

Nominal Average Annual Henry Hub Gas Prices

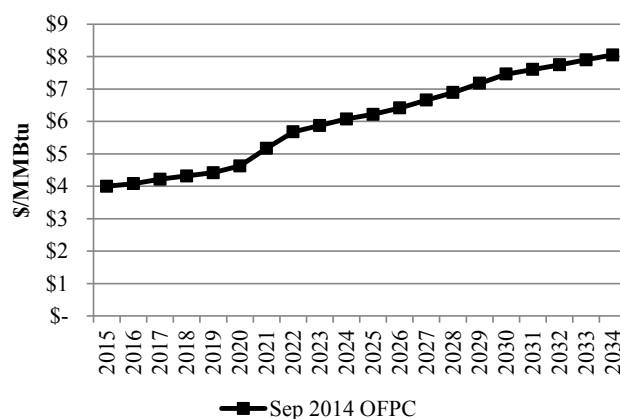

Nominal Average Annual Power Prices (Flat)

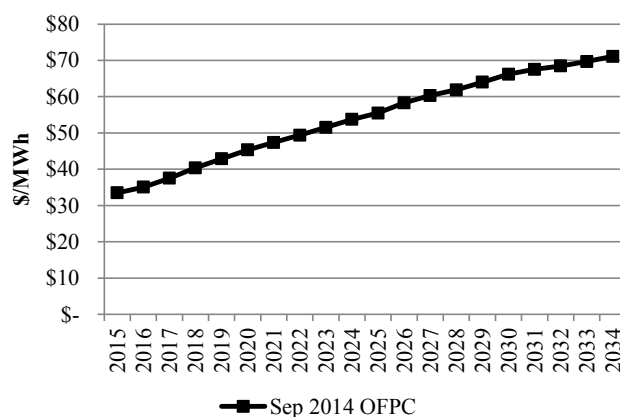

Regional Haze

Case C05-1 reflects Regional Haze Scenario 1, which assumes inter-temporal and fleet trade-off Regional Haze compliance outcomes as shown in the table below. This scenario is for planning purposes recognizing that agency, regulator, and joint owner perspectives on acceptability have not been determined.

Coal Unit	Description
Carbon 1	Shut Down Apr 2015
Carbon 2	Shut Down Apr 2015
Cholla 4	Conversion by Jun 2025
Colstrip 3	SCR by Dec 2023
Colstrip 4	SCR by Dec 2022
Craig 1	SCR by Aug 2021
Craig 2	SCR by Jan 2018
Dave Johnston 1	Shut Down Mar 2019
Dave Johnston 2	Shut Down Dec 2027
Dave Johnston 3	Shut Down Dec 2027
Dave Johnston 4	Shut Down Dec 2032
Hayden 1	SCR by Jun 2015
Hayden 2	SCR by Jun 2016
Hunter 1	SCR by Dec 2021
Hunter 2	Shut Down by Dec 2032
Hunter 3	SCR by Dec 2024
Huntington 1	Shut Down by Dec 2036

Case: C05-1

Coal Unit	Description
Huntington 2	Shut Down by Dec 2021
Jim Bridger 1	Shut Down by Dec 2023
Jim Bridger 2	Shut Down by Dec 2032
Jim Bridger 3	SCR by Dec 2015
Jim Bridger 4	SCR by Dec 2016
Naughton 1	Shut Down by Dec 2029
Naughton 2	Shut Down by Dec 2029
Naughton 3	Conversion by Jun 2018; Shut Down by Dec 2029
Wyodak	Shut Down by Dec 2039

*SCR = selective catalytic reduction

Federal Tax Incentives

- PTCs expire end of 2013
- ITC of 30% expire end of 2016, thereafter it continues in perpetuity at 10%.

Load Forecast

The figure below shows the medium system coincident peak load forecast applicable to this case before accounting for any potential contribution from DSM or distributed generation resources.

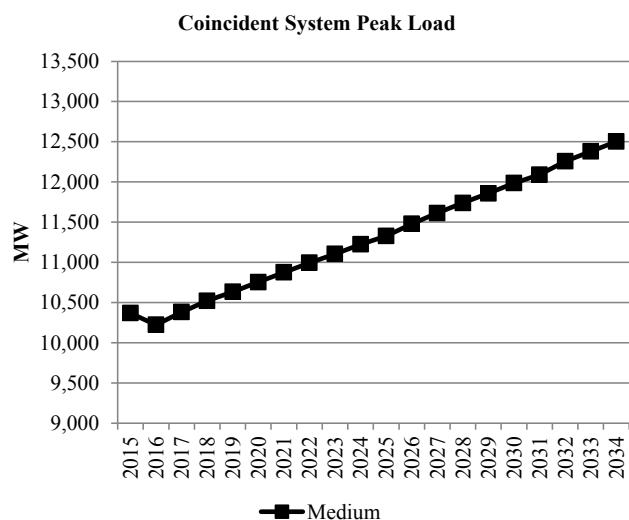

Energy Efficiency (Class 2 DSM)

This case uses base supply curves with economic resource selections up to the achievable potential. Class 2 resources that are not selected in any given year are not available for selection in future years. Achievable potential by state and year are summarized in the following figure.

Class 2 DSM Cumulative Achievable Potential

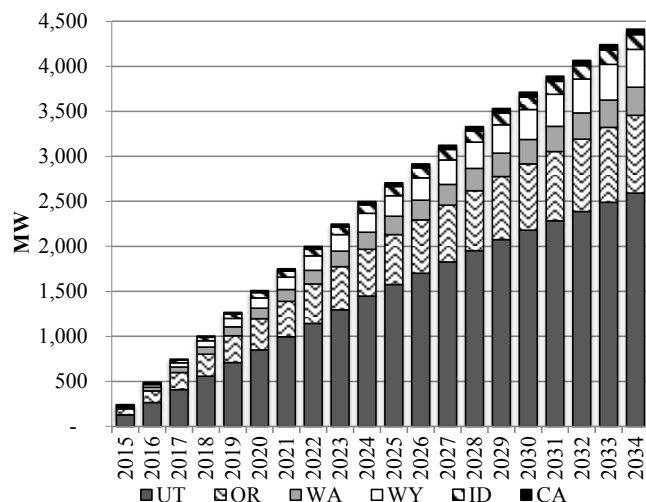

Distributed Generation

Base case distributed generation penetration is assumed in all states. Distributed generation by state and year are summarized below.

Distributed Generation - Base Penetration Case

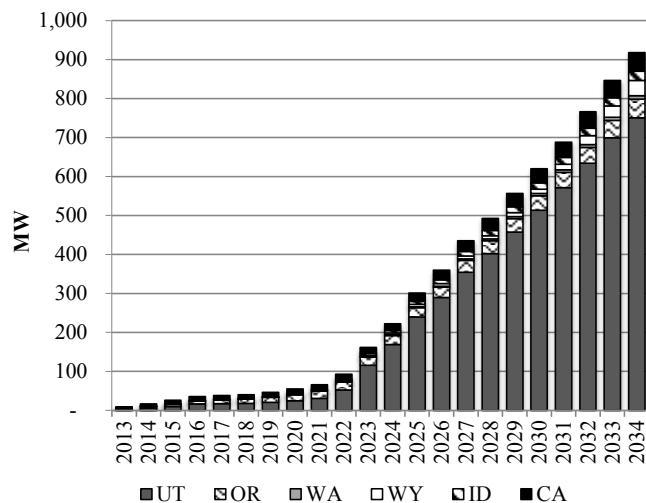

PORTFOLIO SUMMARY

System Optimizer PVRR (\$m)

System Cost without Transmission Upgrades	\$26,603
Transmission Integration	\$36
Transmission Reinforcement	\$6
Total Cost	\$26,646

Resource Portfolio

Cumulative changes to the resource portfolio (new resource additions and resource retirements), represented as nameplate capacity, are summarized in the figure below.

Case: C05-1

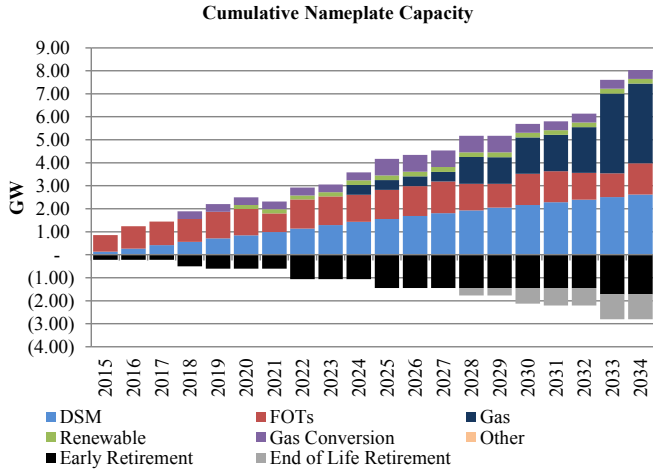

System CO₂ Emissions (System Optimizer)

System CO₂ emissions from System Optimizer are shown alongside those from Cases C01-R and C01-1 in the figure below.

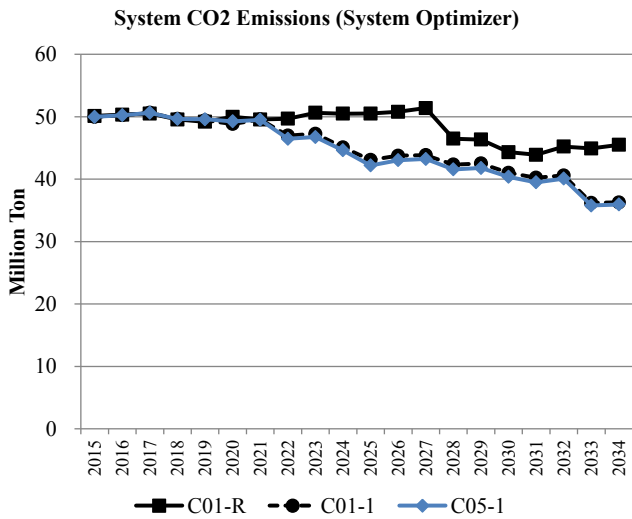

111(d) Compliance Profiles

The following figures summarize how compliance with state emission rate goals is achieved. The sum of each stacked bar represents the fossil emission rate. The net final rate represents the fossil rate after accounting for the emission rate impacts of new thermal (new NGCC units or nuclear, as applicable), re-dispatch of fossil units, energy efficiency (EE), and allocated renewable energy (RE).

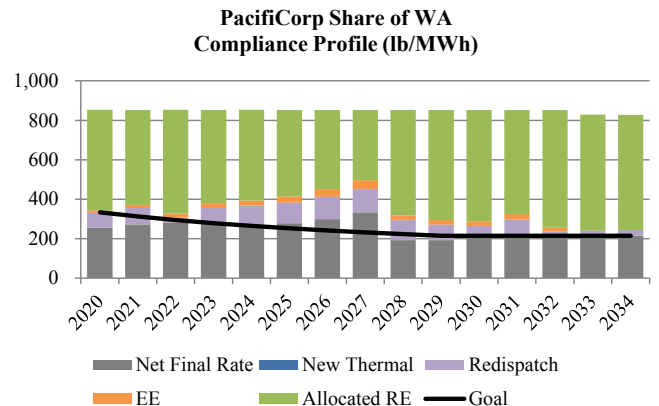
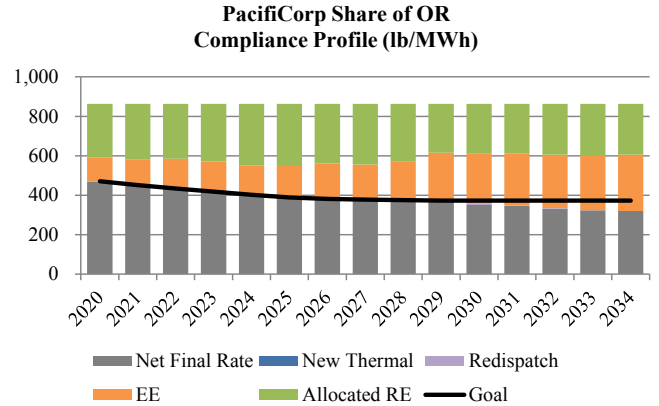
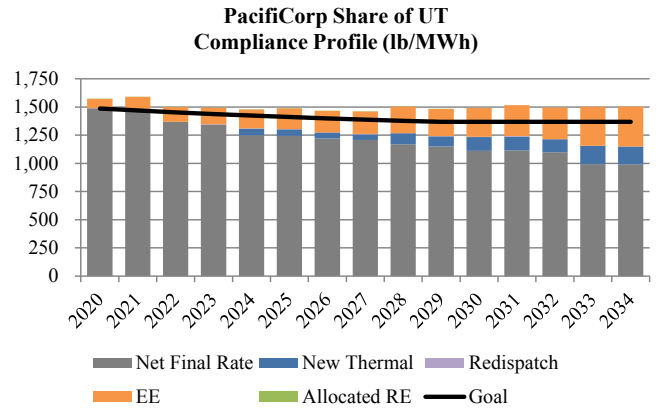
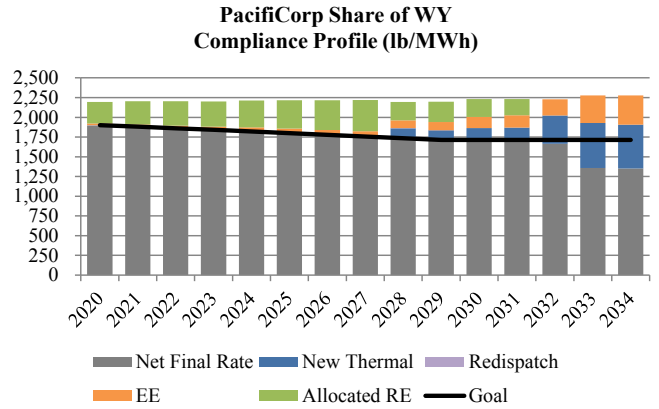

CASE ASSUMPTIONS

Description

Case C05-2 produces a portfolio that meets PacifiCorp’s share of state 111(d) emission rate goals in all states in which PacifiCorp has fossil generation and retail customers. The compliance strategy applied to this case relies on flexible allocation of renewable energy and energy efficiency while prioritizing re-dispatch of fossil generation to achieve incremental emission rate reductions as required. For planning purposes, this case assumes one of two different Regional Haze compliance scenarios reflecting potential inter-temporal and fleet trade-off compliance outcomes.

Federal CO₂ Policy/Price Signal

C05-2 reflects EPA’s proposed 111(d) rule with no additional CO₂ price signal. The table below summarizes the interim emission rate goal and the final emission rate target by state assumed to apply to PacifiCorp’s system.

State	Interim Goal (Avg. 2020-2029) (lb/MWh)	Final Target (2030 & Beyond) (lb/MWh)
WY	1,808	1,714
UT*	1,378	1,322
OR	407	372
WA	264	215

*EPA’s calculation of the target for UT treated PacifiCorp’s Lakeside 2 NGCC plant as an existing resource. The emission rate assumed for UT assumes Lake Side 2 is correctly classified as “under construction”.

The 111(d) compliance strategy implemented for this case is summarized as follows:

- Flexible allocation of system renewable resources and flexible allocation of cumulative energy efficiency savings beginning 2017 from ID and CA, where PacifiCorp does not own fossil generation.
- Cumulative cost-effective selection of energy efficiency beginning 2017.
- New NGCC generation in WY and UT (new NGCC resources are not allowed in OR, WA, and ID).
- Re-dispatch of existing fossil generation, as required.
- Addition of new renewable resources, as required.

Forward Price Curve

Case C05-2 gas and power prices reflect medium natural gas prices and regional compliance with EPA’s proposed 111(d) rule as implemented in the Company’s September 2014 official forward price curve (OFPC).

Nominal Average Annual Henry Hub Gas Prices

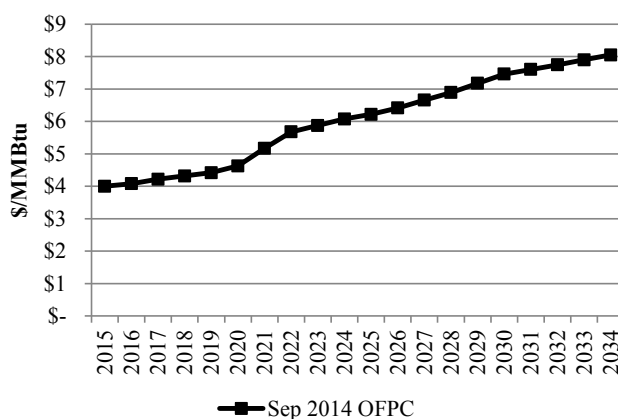

Nominal Average Annual Power Prices (Flat)

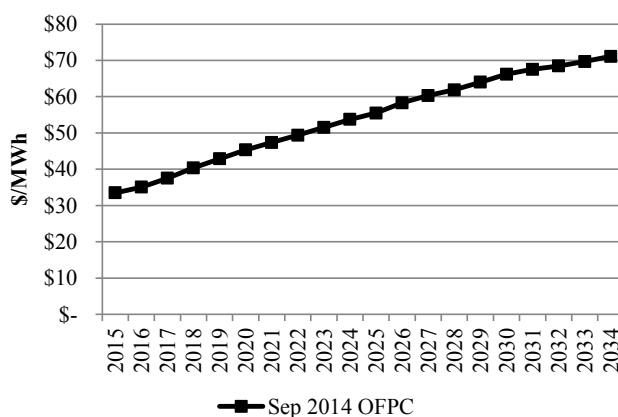

Regional Haze

Case C05-2 reflects Regional Haze Scenario 2, which assumes inter-temporal and fleet trade-off Regional Haze compliance outcomes as shown in the table below. This scenario is for planning purposes recognizing that agency, regulator, and joint owner perspectives on acceptability have not been determined.

Coal Unit	Description
Carbon 1	Shut Down Apr 2015
Carbon 2	Shut Down Apr 2015
Cholla 4	Conversion by Jun 2025
Colstrip 3	SCR by Dec 2023
Colstrip 4	SCR by Dec 2022
Craig 1	SCR by Aug 2021
Craig 2	SCR by Jan 2018
Dave Johnson 1	Shut Down Mar 2019
Dave Johnson 2	Shut Down Dec 2023
Dave Johnson 3	Shut Down Dec 2027
Dave Johnson 4	Shut Down Dec 2032
Hayden 1	SCR by Jun 2015
Hayden 2	SCR by Jun 2016
Hunter 1	SCR by Dec 2021
Hunter 2	Shut Down Dec 2024
Hunter 3	SCR by Dec 2024
Huntington 1	Shut Down Dec 2024
Huntington 2	Shut Down by Dec 2021

Case: C05-2

Coal Unit	Description
Jim Bridger 1	Shut Down by Dec 2023
Jim Bridger 2	Shut Down by Dec 2028
Jim Bridger 3	SCR by Dec 2015
Jim Bridger 4	SCR by Dec 2016
Naughton 1	Shut Down by Dec 2029
Naughton 2	Shut Down by Dec 2029
Naughton 3	Conversion by Jun 2018; Shut Down by Dec 2029
Wyodak	Shut Down by Dec 2032

*SCR = selective catalytic reduction

Federal Tax Incentives

- PTCs expire end of 2013
- ITC of 30% expire end of 2016, thereafter it continues in perpetuity at 10%.

Load Forecast

The figure below shows the medium system coincident peak load forecast applicable to this case before accounting for any potential contribution from DSM or distributed generation resources.

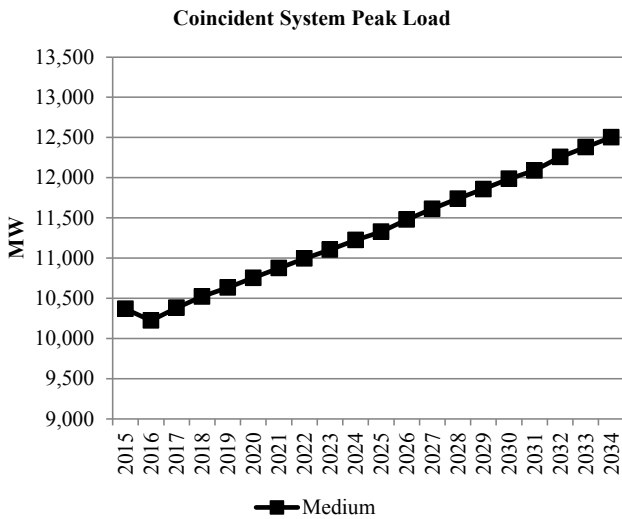

Energy Efficiency (Class 2 DSM)

This case uses base supply curves with economic resource selections up to the achievable potential. Class 2 resources that are not selected in any given year are not available for selection in future years. Achievable potential by state and year are summarized in the following figure.

Class 2 DSM Cumulative Achievable Potential

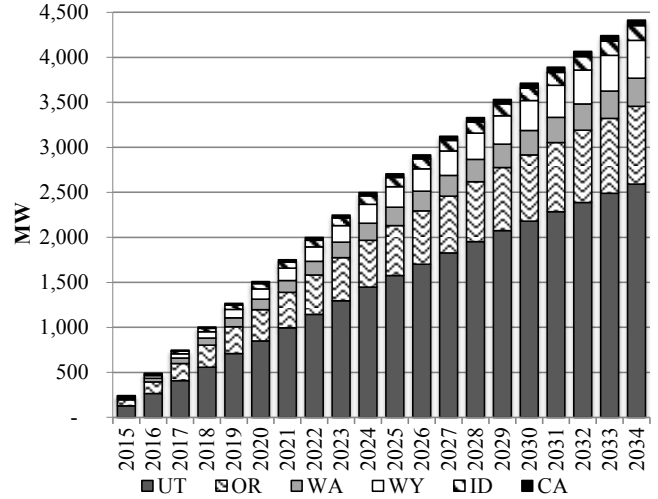

Distributed Generation

Base case distributed generation penetration is assumed in all states. Distributed generation by state and year are summarized below.

Distributed Generation - Base Penetration Case

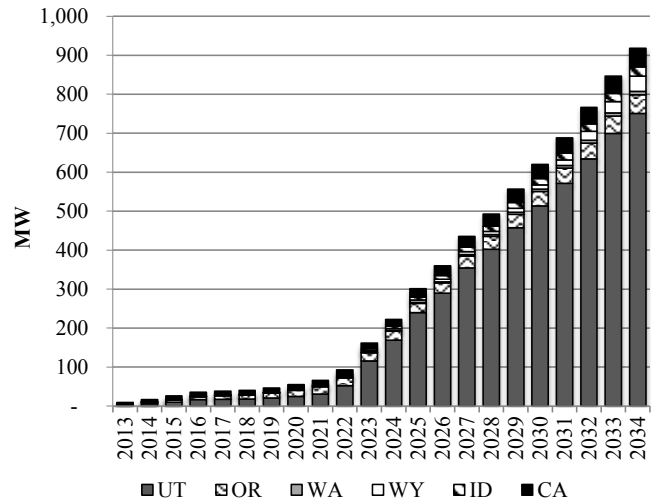

PORTFOLIO SUMMARY

System Optimizer PVRR (\$m)

System Cost without Transmission Upgrades	\$27,127
Transmission Integration	\$41
Transmission Reinforcement	\$10
Total Cost	\$27,177

Resource Portfolio

Cumulative changes to the resource portfolio (new resource additions and resource retirements), represented as nameplate capacity, are summarized in the figure below.

Case: C05-2

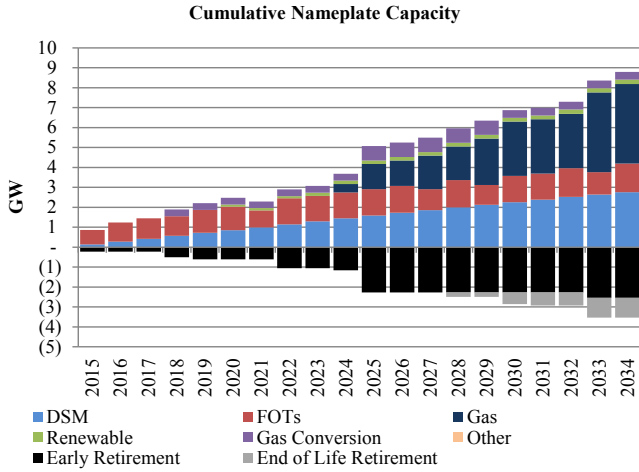

System CO₂ Emissions (System Optimizer)

System CO₂ emissions from System Optimizer are shown alongside those from Cases C01-R and C01-2 in the figure below.

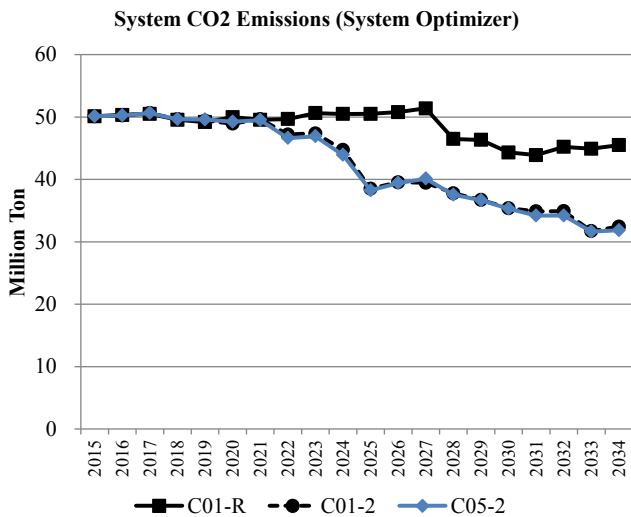

111(d) Compliance Profiles

The following figures summarize how compliance with state emission rate goals is achieved. The sum of each stacked bar represents the fossil emission rate. The net final rate represents the fossil rate after accounting for the emission rate impacts of new thermal (new NGCC units or nuclear, as applicable), re-dispatch of fossil units, energy efficiency (EE), and allocated renewable energy (RE).

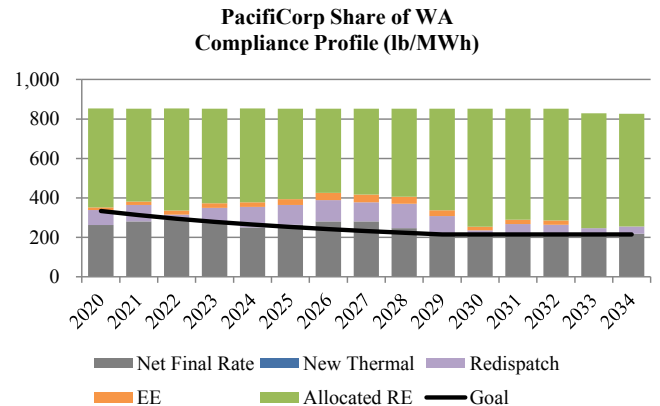
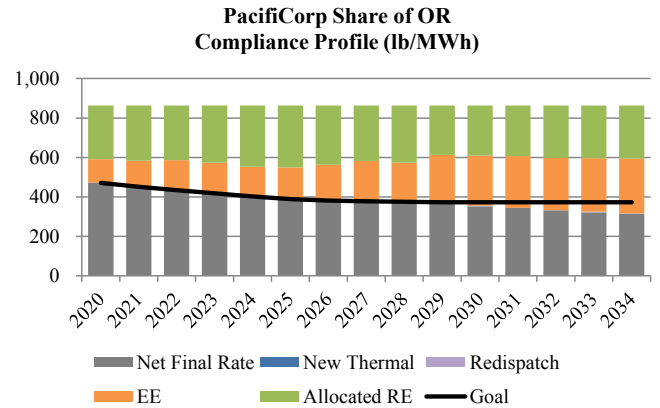
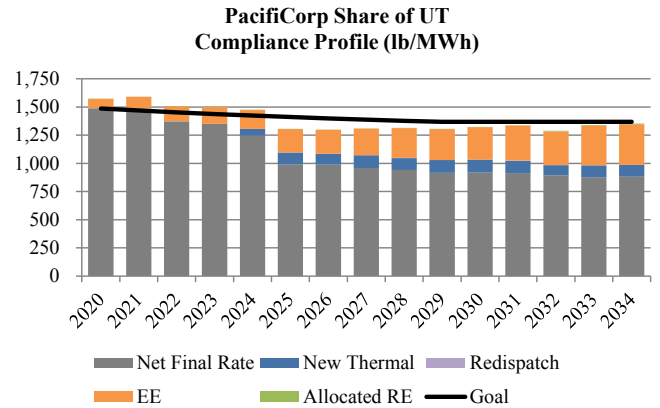
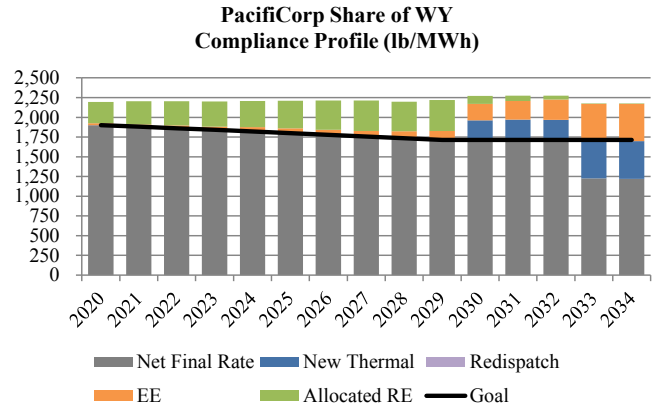

CASE ASSUMPTIONS

Description

Case C05-3 is an alternative to Cases C05-1 and C05-2 incorporating a different assumption for assumed outcome for Regional Haze compliance outcomes. The case produces a portfolio that meets PacifiCorp’s share of state 111(d) emission rate goals in all states in which PacifiCorp has fossil generation and retail customers. The compliance strategy applied to this case relies on flexible allocation of renewable energy and energy efficiency while prioritizing re-dispatch of fossil generation to achieve incremental emission rate reductions as required. For planning purposes, this case assumes an alternative to the two Regional Haze compliance scenarios reflecting potential inter-temporal and fleet trade-off compliance outcomes.

Federal CO₂ Policy/Price Signal

C05-3 reflects EPA’s proposed 111(d) rule with no additional CO₂ price signal. The table below summarizes the interim emission rate goal and the final emission rate target by state assumed to apply to PacifiCorp’s system.

State	Interim Goal (Avg. 2020-2029) (lb/MWh)	Final Target (2030 & Beyond) (lb/MWh)
WY	1,808	1,714
UT*	1,378	1,322
OR	407	372
WA	264	215

*EPA’s calculation of the target for UT treated PacifiCorp’s Lakeside 2 NGCC plant as an existing resource. The emission rate assumed for UT assumes Lake Side 2 is correctly classified as “under construction”.

The 111(d) compliance strategy implemented for this case is summarized as follows:

- Flexible allocation of system renewable resources and flexible allocation of cumulative energy efficiency savings beginning 2017 from ID and CA, where PacifiCorp does not own fossil generation.
- Cumulative cost-effective selection of energy efficiency beginning 2017.
- New NGCC generation in WY and UT (new NGCC resources are not allowed in OR, WA, and ID).
- Re-dispatch of existing fossil generation, as required.
- Addition of new renewable resources, as required.

Forward Price Curve

Case C05-3 gas and power prices reflect medium natural gas prices and regional compliance with EPA’s proposed 111(d) rule as implemented in the Company’s September 2014 official forward price curve (OFPC).

Nominal Average Annual Henry Hub Gas Prices

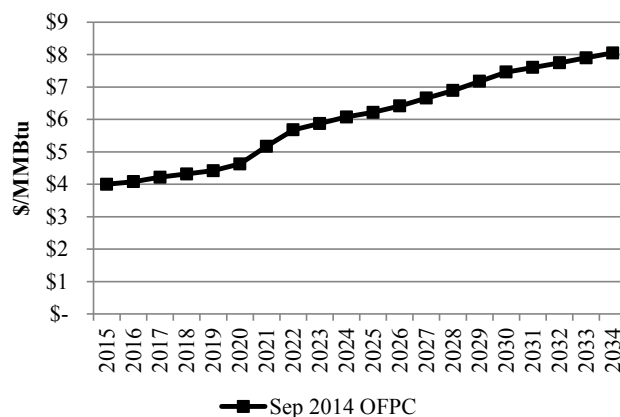

Nominal Average Annual Power Prices (Flat)

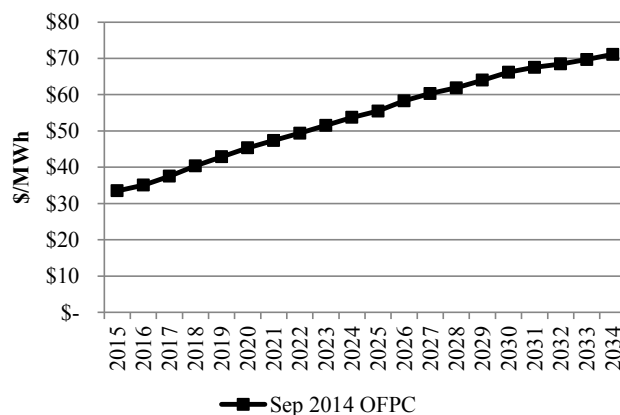

Regional Haze

Case C05-3 reflects an alternative to Regional Haze Scenarios 1 and 2, which assumes inter-temporal and fleet trade-off Regional Haze compliance outcomes as shown in the table below. This scenario is for planning purposes recognizing that agency, regulator, and joint owner perspectives on acceptability have not been determined.

Coal Unit	Description
Carbon 1	Shut Down Apr 2015
Carbon 2	Shut Down Apr 2015
Cholla 4	Conversion by Jun 2025
Colstrip 3	SCR by Dec 2023
Colstrip 4	SCR by Dec 2022
Craig 1	SCR by Aug 2021
Craig 2	SCR by Jan 2018
Dave Johnson 1	Shut Down Dec 2027
Dave Johnson 2	Shut Down Dec 2027
Dave Johnson 3	Shut Down Dec 2027
Dave Johnson 4	Shut Down Dec 2027
Hayden 1	SCR by Jun 2015
Hayden 2	SCR by Jun 2016
Hunter 1	SCR by Dec 2021
Hunter 2	Shut Down Dec 2032
Hunter 3	SCR by Dec 2024
Huntington 1	SCR by Dec 2022

Case: C05-3

Coal Unit	Description
Huntington 2	Shut Down by Dec 2029
Jim Bridger 1	SCR by Dec 2022
Jim Bridger 2	SCR by Dec 2021
Jim Bridger 3	SCR by Dec 2015
Jim Bridger 4	SCR by Dec 2016
Naughton 1	Shut Down by Dec 2029
Naughton 2	Shut Down by Dec 2029
Naughton 3	Conversion by Jun 2018; Shut Down by Dec 2029
Wyodak	Shut Down by Dec 2039

*SCR = selective catalytic reduction

Federal Tax Incentives

- PTCs expire end of 2013
- ITC of 30% expire end of 2016, thereafter it continues in perpetuity at 10%.

Load Forecast

The figure below shows the medium system coincident peak load forecast applicable to this case before accounting for any potential contribution from DSM or distributed generation resources.

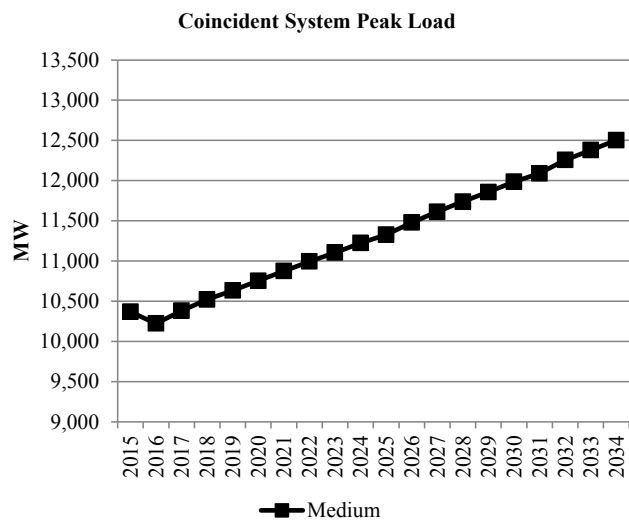

Energy Efficiency (Class 2 DSM)

This case uses base supply curves with economic resource selections up to the achievable potential. Class 2 resources that are not selected in any given year are not available for selection in future years. Achievable potential by state and year are summarized in the following figure.

Class 2 DSM Cumulative Achievable Potential

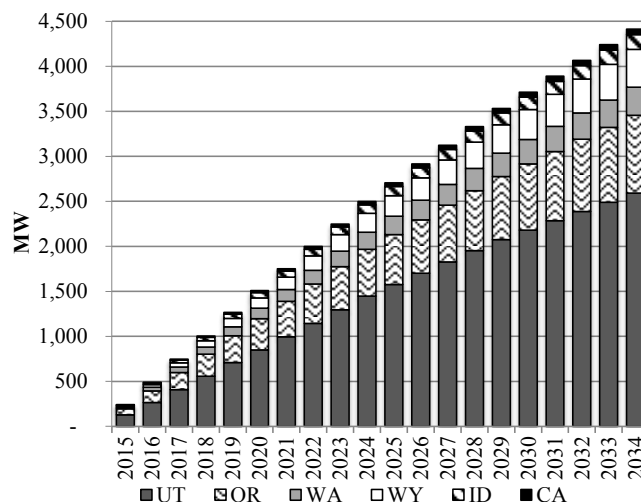

Distributed Generation

Base case distributed generation penetration is assumed in all states. Distributed generation by state and year are summarized below.

Distributed Generation - Base Penetration Case

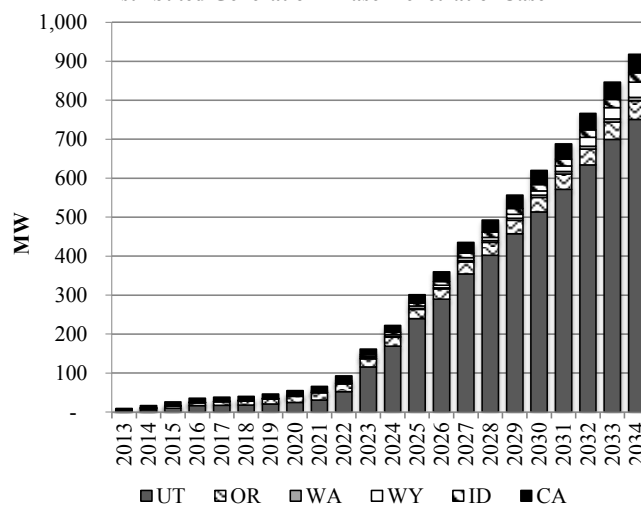

PORTFOLIO SUMMARY

System Optimizer PVRR (\$m)

System Cost without Transmission Upgrades	\$26,569
Transmission Integration	\$40
Transmission Reinforcement	\$6
Total Cost	\$26,615

Resource Portfolio

Cumulative changes to the resource portfolio (new resource additions and resource retirements), represented as nameplate capacity, are summarized in the figure below.

Case: C05-3

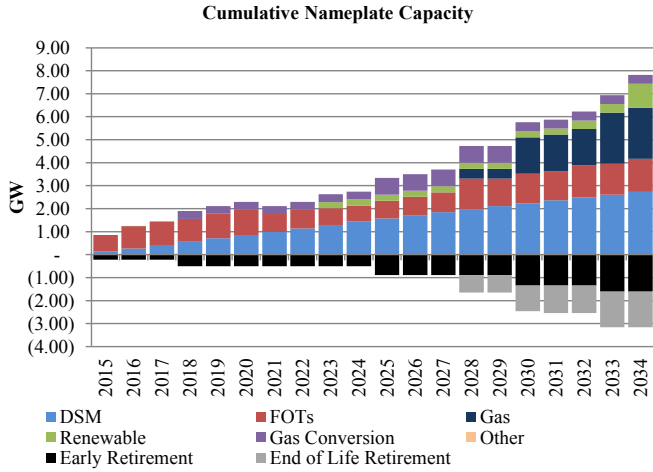

System CO₂ Emissions (System Optimizer)

System CO₂ emissions from System Optimizer are shown alongside those from Cases C01-R, C01-1 and C01-2 in the figure below.

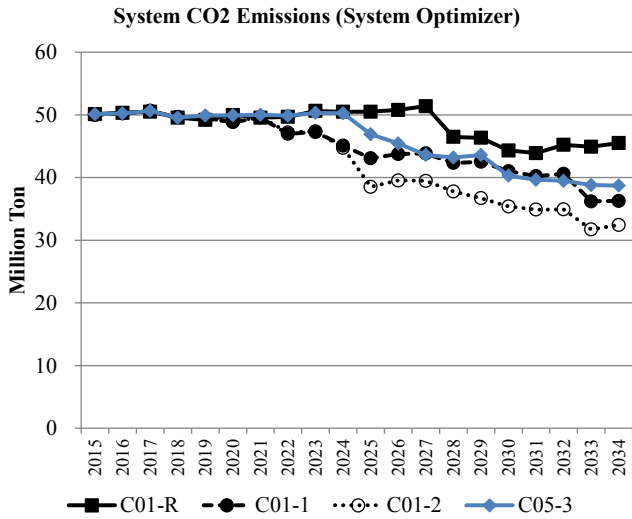

111(d) Compliance Profiles

The following figures summarize how compliance with state emission rate goals is achieved. The sum of each stacked bar represents the fossil emission rate. The net final rate represents the fossil rate after accounting for the emission rate impacts of new thermal (new NGCC units or nuclear, as applicable), re-dispatch of fossil units, energy efficiency (EE), and allocated renewable energy (RE).

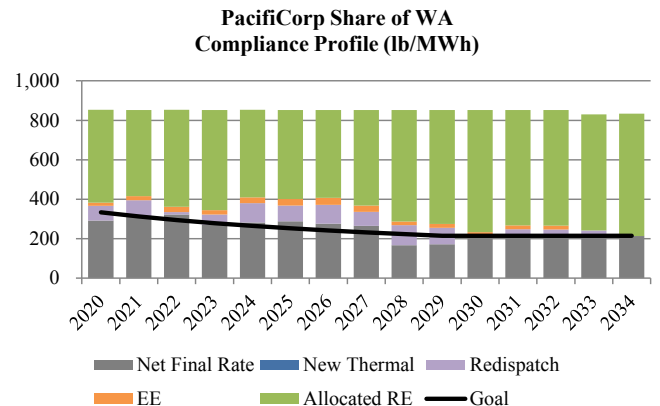
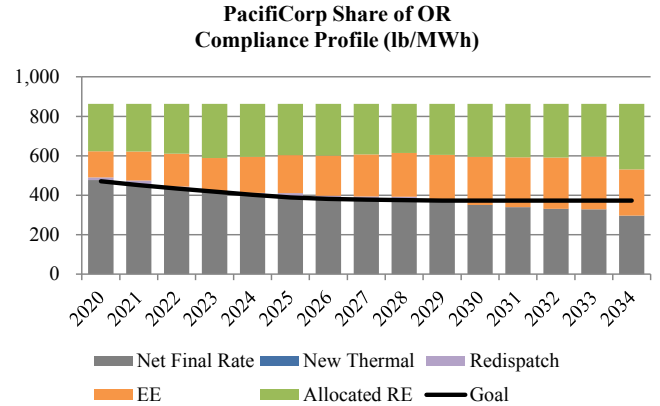
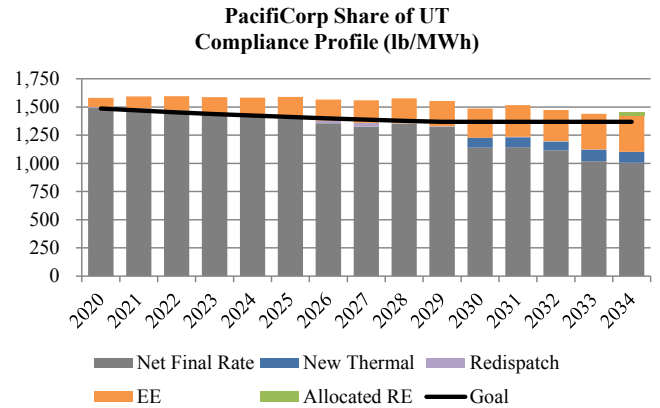
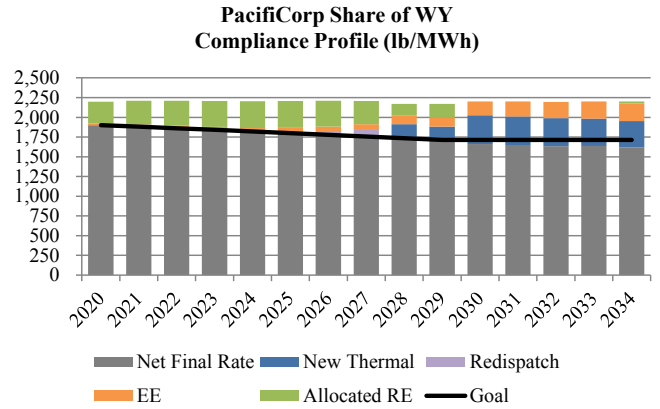

CASE ASSUMPTIONS

Description

Case C05a-1 is an alternative to Case C05-1 that assumes future Oregon RPS requirements can be deferred with acquisition of unbundled Renewable Energy Credits (RECs) in the 2015-2019 timeframe. The case produces a portfolio that meets PacifiCorp’s share of state 111(d) emission rate goals in all states in which PacifiCorp has fossil generation and retail customers. The compliance strategy applied to this case relies on flexible allocation of renewable energy and energy efficiency while prioritizing re-dispatch of fossil generation to achieve incremental emission rate reductions as required. For planning purposes, this case assumes one of two different Regional Haze compliance scenarios reflecting potential inter-temporal and fleet trade-off compliance outcomes.

Federal CO₂ Policy/Price Signal

C05a-1 reflects EPA’s proposed 111(d) rule with no additional CO₂ price signal. The table below summarizes the interim emission rate goal and the final emission rate target by state assumed to apply to PacifiCorp’s system.

State	Interim Goal (Avg. 2020-2029) (lb/MWh)	Final Target (2030 & Beyond) (lb/MWh)
WY	1,808	1,714
UT*	1,378	1,322
OR	407	372
WA	264	215

*EPA’s calculation of the target for UT treated PacifiCorp’s Lakeside 2 NGCC plant as an existing resource. The emission rate assumed for UT assumes Lake Side 2 is correctly classified as “under construction”.

The 111(d) compliance strategy implemented for this case is summarized as follows:

- Flexible allocation of system renewable resources and flexible allocation of cumulative energy efficiency savings beginning 2017 from ID and CA, where PacifiCorp does not own fossil generation.
- Cumulative cost-effective selection of energy efficiency beginning 2017.
- New NGCC generation in WY and UT (new NGCC resources are not allowed in OR, WA, and ID).
- Re-dispatch of existing fossil generation, as required.
- Addition of new renewable resources, as required.

Forward Price Curve

Case C05a-1 gas and power prices reflect medium natural gas prices and regional compliance with EPA’s proposed 111(d) rule as implemented in the Company’s September 2014 official forward price curve (OFPC).

Nominal Average Annual Henry Hub Gas Prices

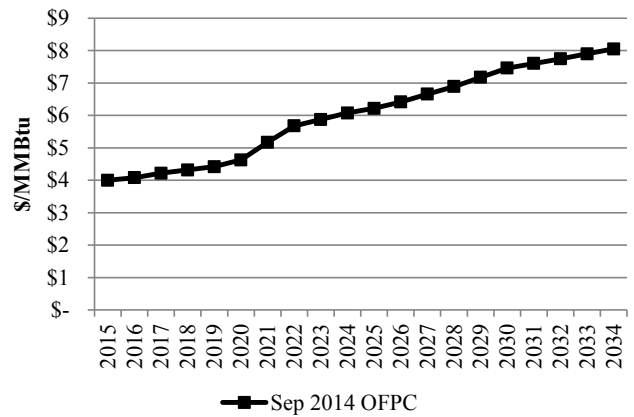

Nominal Average Annual Power Prices (Flat)

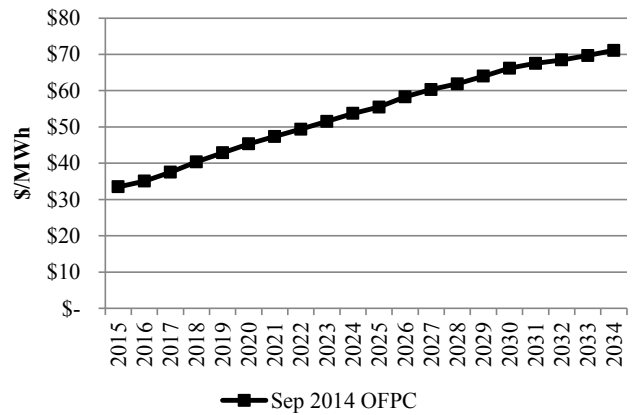

Regional Haze

Case C05a-1 reflects Regional Haze Scenario 1, which assumes inter-temporal and fleet trade-off Regional Haze compliance outcomes as shown in the table below. This scenario is for planning purposes recognizing that agency, regulator, and joint owner perspectives on acceptability have not been determined.

Coal Unit	Description
Carbon 1	Shut Down Apr 2015
Carbon 2	Shut Down Apr 2015
Cholla 4	Conversion by Jun 2025
Colstrip 3	SCR by Dec 2023
Colstrip 4	SCR by Dec 2022
Craig 1	SCR by Aug 2021
Craig 2	SCR by Jan 2018
Dave Johnston 1	Shut Down Mar 2019
Dave Johnston 2	Shut Down Dec 2027
Dave Johnston 3	Shut Down Dec 2027
Dave Johnston 4	Shut Down Dec 2032
Hayden 1	SCR by Jun 2015
Hayden 2	SCR by Jun 2016
Hunter 1	SCR by Dec 2021
Hunter 2	Shut Down by Dec 2032
Hunter 3	SCR by Dec 2024
Huntington 1	Shut Down by Dec 2036

Case: C05a-1

Coal Unit	Description
Huntington 2	Shut Down by Dec 2021
Jim Bridger 1	Shut Down by Dec 2023
Jim Bridger 2	Shut Down by Dec 2032
Jim Bridger 3	SCR by Dec 2015
Jim Bridger 4	SCR by Dec 2016
Naughton 1	Shut Down by Dec 2029
Naughton 2	Shut Down by Dec 2029
Naughton 3	Conversion by Jun 2018; Shut Down by Dec 2029
Wyodak	Shut Down by Dec 2039

*SCR = selective catalytic reduction

Federal Tax Incentives

- PTCs expire end of 2013
- ITC of 30% expire end of 2016, thereafter it continues in perpetuity at 10%.

Load Forecast

The figure below shows the medium system coincident peak load forecast applicable to this case before accounting for any potential contribution from DSM or distributed generation resources.

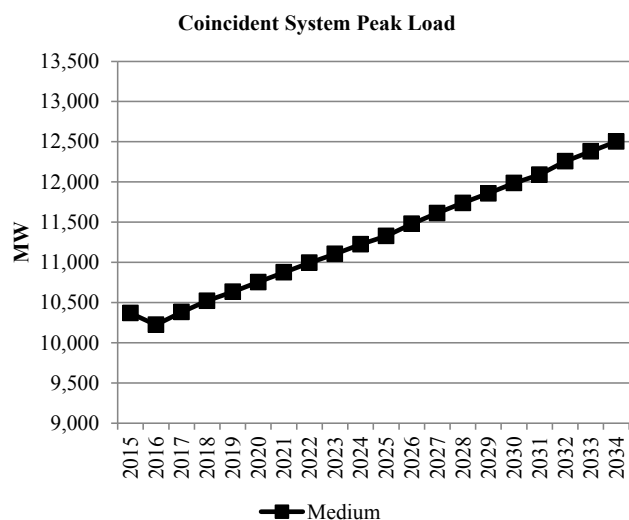

Energy Efficiency (Class 2 DSM)

This case uses base supply curves with economic resource selections up to the achievable potential. Class 2 resources that are not selected in any given year are not available for selection in future years. Achievable potential by state and year are summarized in the following figure.

Class 2 DSM Cumulative Achievable Potential

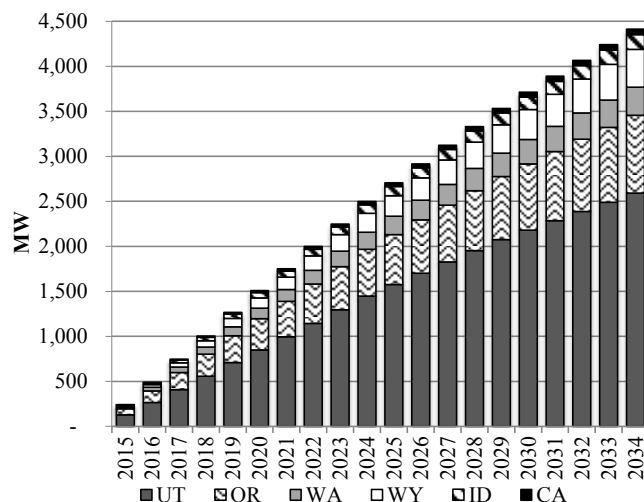

Distributed Generation

Base case distributed generation penetration is assumed in all states. Distributed generation by state and year are summarized below.

Distributed Generation - Base Penetration Case

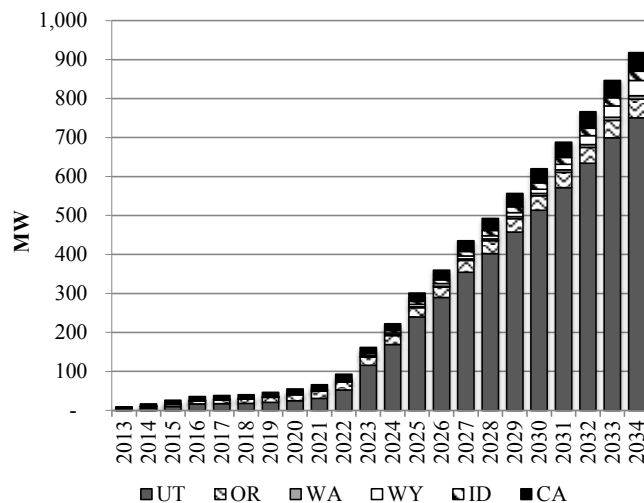

PORTFOLIO SUMMARY

System Optimizer PVRR (\$m)

System Cost without Transmission Upgrades	\$26,566
Transmission Integration	\$19
Transmission Reinforcement	\$6
Total Cost	\$26,591

Resource Portfolio

Cumulative changes to the resource portfolio (new resource additions and resource retirements), represented as nameplate capacity, are summarized in the figure below.

Case: C05a-1

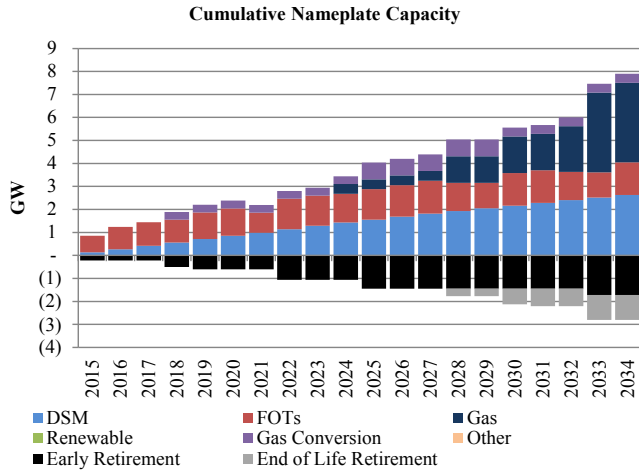

System CO₂ Emissions (System Optimizer)

System CO₂ emissions from System Optimizer are shown alongside those from Cases C01-R and C01-1 in the figure below.

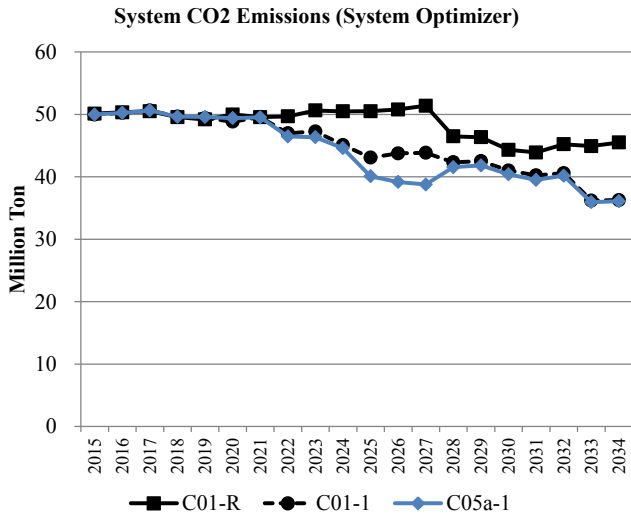

111(d) Compliance Profiles

The following figures summarize how compliance with state emission rate goals is achieved. The sum of each stacked bar represents the fossil emission rate. The net final rate represents the fossil rate after accounting for the emission rate impacts of new thermal (new NGCC units or nuclear, as applicable), re-dispatch of fossil units, energy efficiency (EE), and allocated renewable energy (RE).

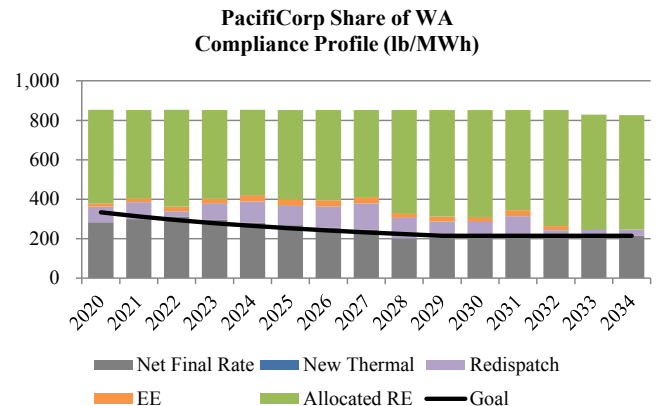
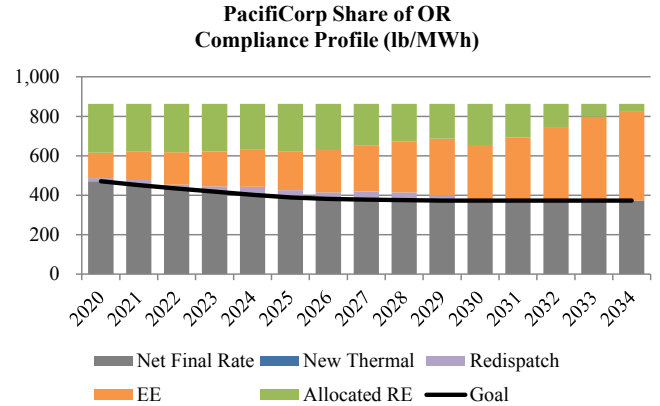
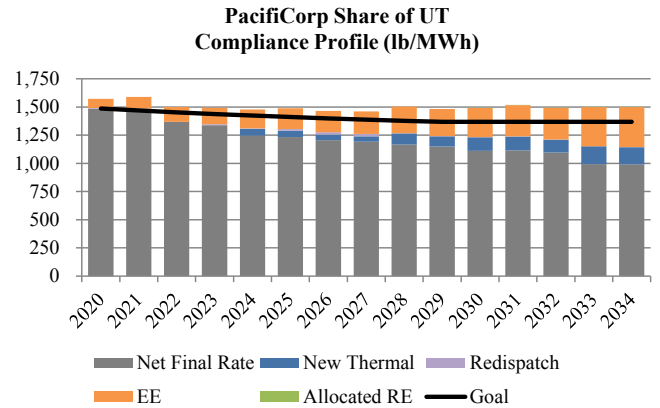
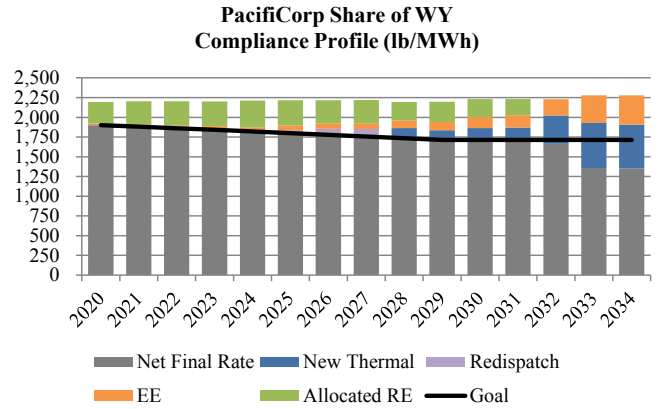

Case: C05b-1

Description

Case C05b-1 is an alternative to Case C05-1 that delays building resources to meet Oregon RPS requirements until the balance of banked RECs is exhausted. This results in resource additions in 2028 to meet state requirements. The case produces a portfolio that meets PacifiCorp's share of state 111(d) emission rate goals in all states in which PacifiCorp has fossil generation and retail customers. The compliance strategy applied to this case relies on flexible allocation of renewable energy and energy efficiency while prioritizing re-dispatch of fossil generation to achieve incremental emission rate reductions as required. For planning purposes, this case assumes one of two different Regional Haze compliance scenarios reflecting potential inter-temporal and fleet trade-off compliance outcomes.

Federal CO₂ Policy/Price Signal

C05a-1 reflects EPA's proposed 111(d) rule with no additional CO₂ price signal. The table below summarizes the interim emission rate goal and the final emission rate target by state assumed to apply to PacifiCorp's system.

State	Interim Goal (Avg. 2020-2029) (lb/MWh)	Final Target (2030 & Beyond) (lb/MWh)
WY	1,808	1,714
UT*	1,378	1,322
OR	407	372
WA	264	215

*EPA's calculation of the target for UT treated PacifiCorp's Lakeside 2 NGCC plant as an existing resource. The emission rate assumed for UT assumes Lake Side 2 is correctly classified as "under construction".

The 111(d) compliance strategy implemented for this case is summarized as follows:

- Flexible allocation of system renewable resources and flexible allocation of cumulative energy efficiency savings beginning 2017 from ID and CA, where PacifiCorp does not own fossil generation.
- Cumulative cost-effective selection of energy efficiency beginning 2017.
- New NGCC generation in WY and UT (new NGCC resources are not allowed in OR, WA, and ID).
- Re-dispatch of existing fossil generation, as required.
- Addition of new renewable resources, as required.

Forward Price Curve

Case C05b-1 gas and power prices reflect medium natural gas prices and regional compliance with EPA's proposed 111(d) rule as implemented in the Company's September 2014 official forward price curve (OFPC).

Nominal Average Annual Henry Hub Gas Prices

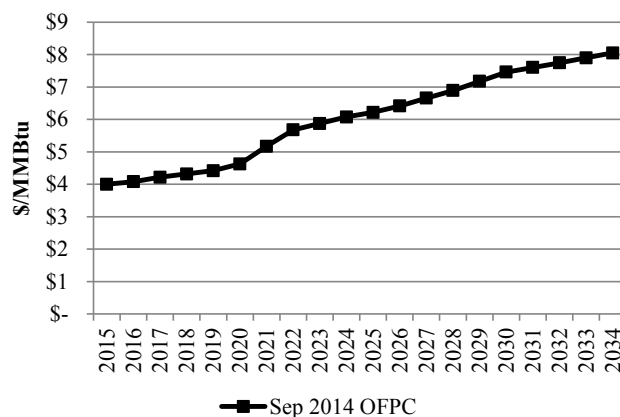

Nominal Average Annual Power Prices (Flat)

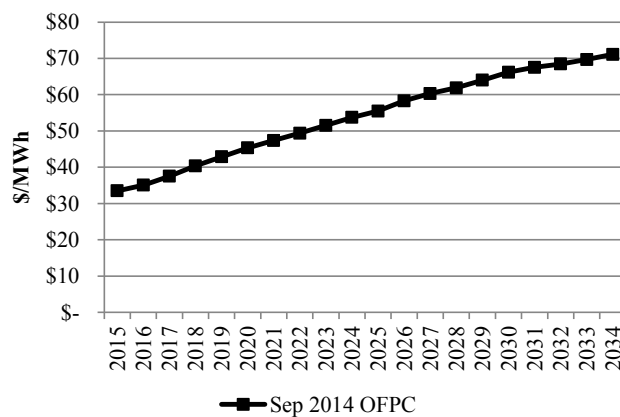

Regional Haze

Case C05b-1 reflects Regional Haze Scenario 1, which assumes inter-temporal and fleet trade-off Regional Haze compliance outcomes as shown in the table below. This scenario is for planning purposes recognizing that agency, regulator, and joint owner perspectives on acceptability have not been determined.

Coal Unit	Description
Carbon 1	Shut Down Apr 2015
Carbon 2	Shut Down Apr 2015
Cholla 4	Conversion by Jun 2025
Colstrip 3	SCR by Dec 2023
Colstrip 4	SCR by Dec 2022
Craig 1	SCR by Aug 2021
Craig 2	SCR by Jan 2018
Dave Johnston 1	Shut Down Mar 2019
Dave Johnston 2	Shut Down Dec 2027
Dave Johnston 3	Shut Down Dec 2027
Dave Johnston 4	Shut Down Dec 2032
Hayden 1	SCR by Jun 2015
Hayden 2	SCR by Jun 2016
Hunter 1	SCR by Dec 2021
Hunter 2	Shut Down by Dec 2032
Hunter 3	SCR by Dec 2024
Huntington 1	Shut Down by Dec 2036

Case: C05b-1

Coal Unit	Description
Huntington 2	Shut Down by Dec 2021
Jim Bridger 1	Shut Down by Dec 2023
Jim Bridger 2	Shut Down by Dec 2032
Jim Bridger 3	SCR by Dec 2015
Jim Bridger 4	SCR by Dec 2016
Naughton 1	Shut Down by Dec 2029
Naughton 2	Shut Down by Dec 2029
Naughton 3	Conversion by Jun 2018; Shut Down by Dec 2029
Wyodak	Shut Down by Dec 2039

*SCR = selective catalytic reduction

Federal Tax Incentives

- PTCs expire end of 2013
- ITC of 30% expire end of 2016, thereafter it continues in perpetuity at 10%.

Load Forecast

The figure below shows the medium system coincident peak load forecast applicable to this case before accounting for any potential contribution from DSM or distributed generation resources.

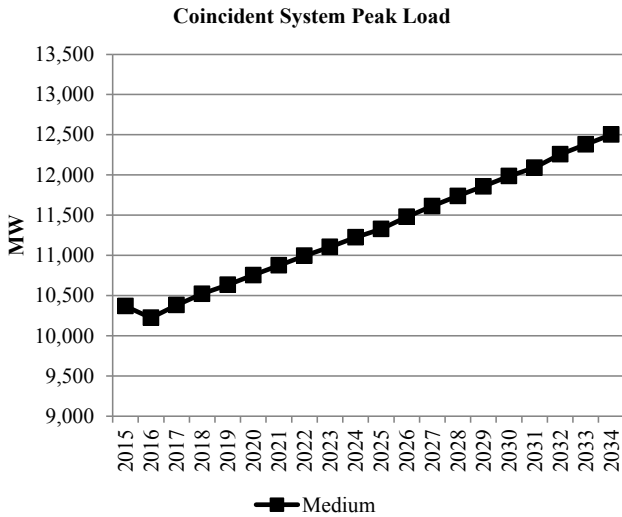

Energy Efficiency (Class 2 DSM)

This case uses base supply curves with economic resource selections up to the achievable potential. Class 2 resources that are not selected in any given year are not available for selection in future years. Achievable potential by state and year are summarized in the following figure.

Class 2 DSM Cumulative Achievable Potential

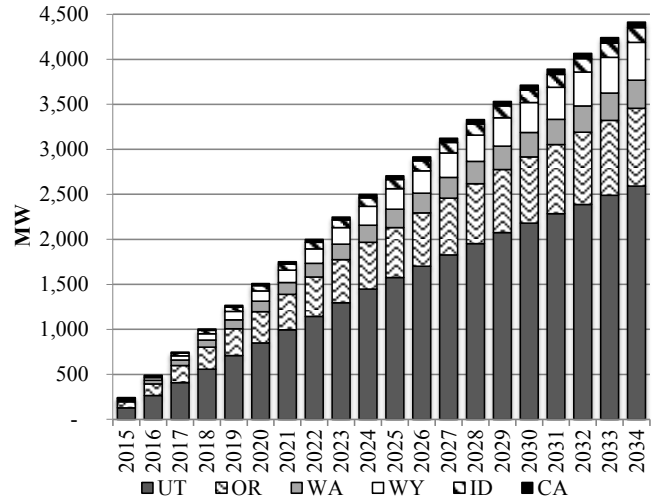

Distributed Generation

Base case distributed generation penetration is assumed in all states. Distributed generation by state and year are summarized below.

Distributed Generation - Base Penetration Case

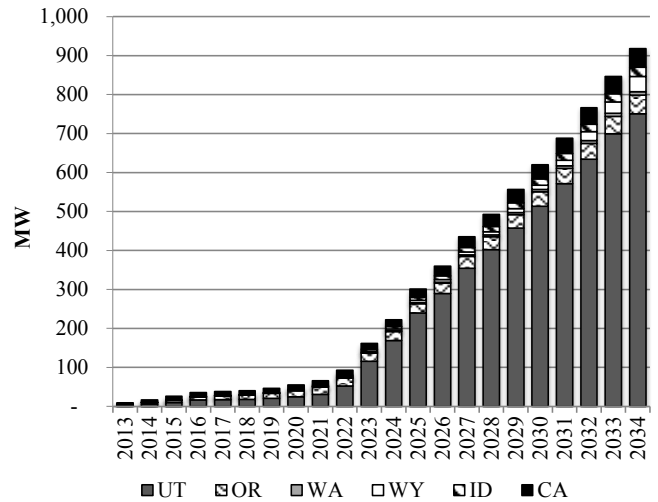

PORTFOLIO SUMMARY

System Optimizer PVRR (\$m)

System Cost without Transmission Upgrades	\$26,605
Transmission Integration	\$38
Transmission Reinforcement	\$6
Total Cost	\$26,649

Resource Portfolio

Cumulative changes to the resource portfolio (new resource additions and resource retirements), represented as nameplate capacity, are summarized in the figure below.

Case: C05b-1

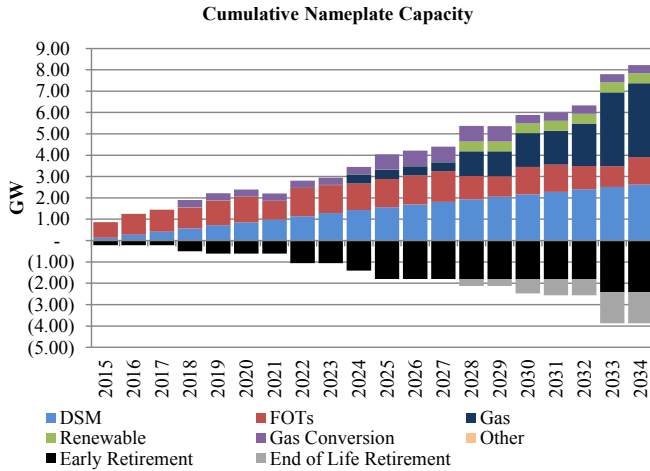

System CO₂ Emissions (System Optimizer)

System CO₂ emissions from System Optimizer are shown alongside those from Cases C01-R, C01-1 and C01-2 in the figure below.

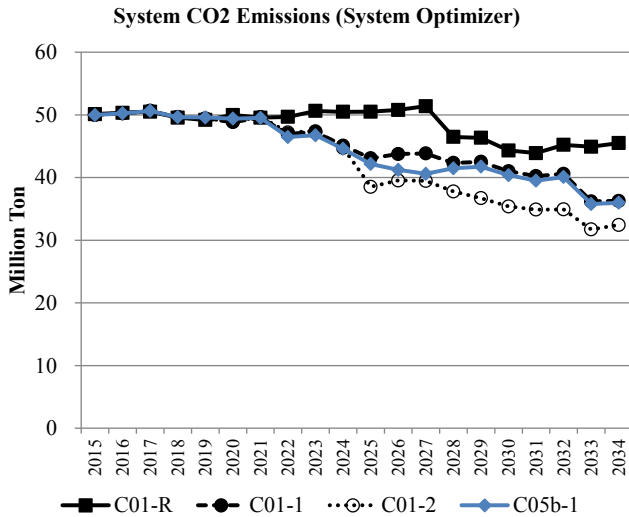

111(d) Compliance Profiles

The following figures summarize how compliance with state emission rate goals is achieved. The sum of each stacked bar represents the fossil emission rate. The net final rate represents the fossil rate after accounting for the emission rate impacts of new thermal (new NGCC units or nuclear, as applicable), re-dispatch of fossil units, energy efficiency (EE), and allocated renewable energy (RE).

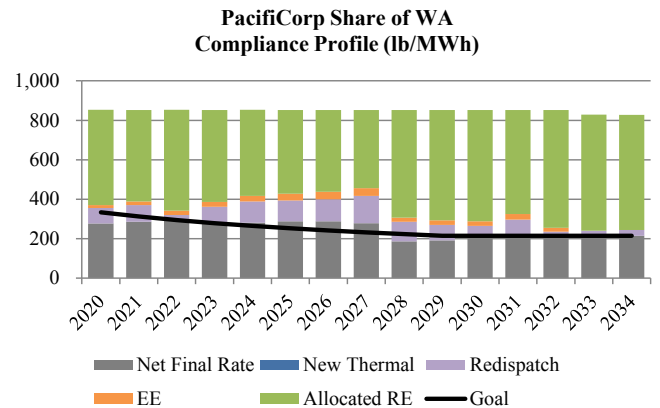
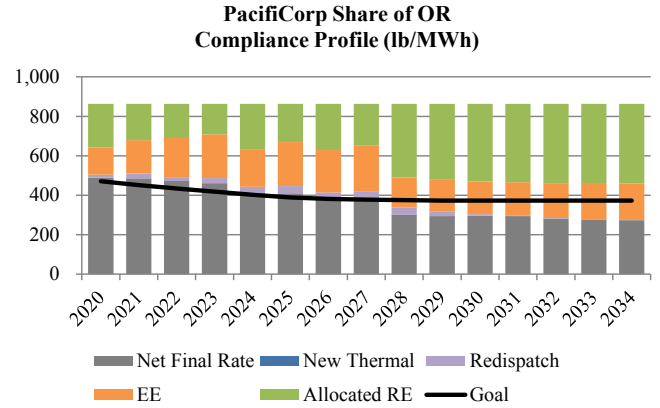
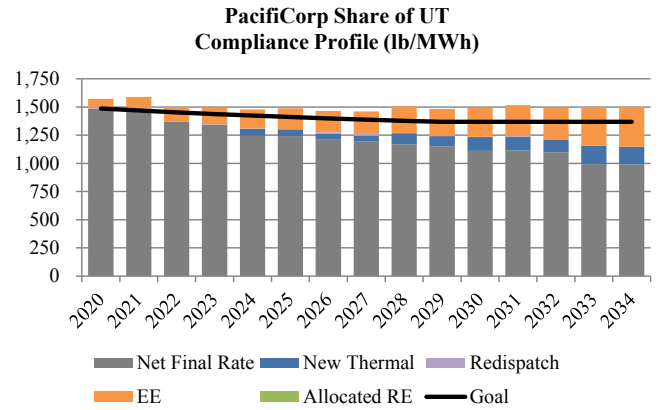
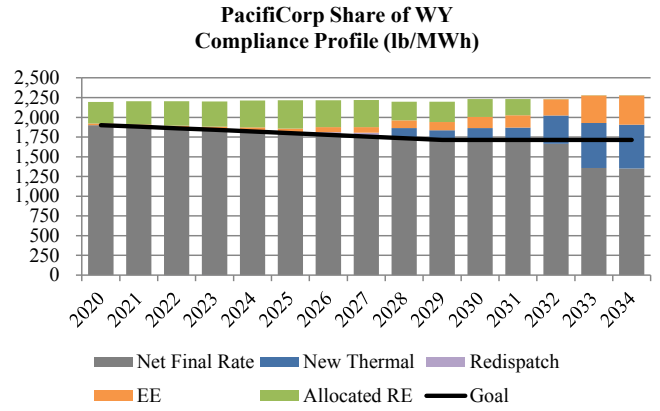

CASE ASSUMPTIONS

Description

Case C05a-2 is an alternative to Case C05-2 that assumes future Oregon RPS requirements can be deferred with acquisition of unbundled Renewable Energy Credits (RECs) in the 2015-2019 timeframe. The case produces a portfolio that meets PacifiCorp’s share of state 111(d) emission rate goals in all states in which PacifiCorp has fossil generation and retail customers. The compliance strategy applied to this case relies on flexible allocation of renewable energy and energy efficiency while prioritizing re-dispatch of fossil generation to achieve incremental emission rate reductions as required. For planning purposes, this case assumes one of two different Regional Haze compliance scenarios reflecting potential inter-temporal and fleet trade-off compliance outcomes.

Federal CO₂ Policy/Price Signal

C05a-2 reflects EPA’s proposed 111(d) rule with no additional CO₂ price signal. The table below summarizes the interim emission rate goal and the final emission rate target by state assumed to apply to PacifiCorp’s system.

State	Interim Goal (Avg. 2020-2029) (lb/MWh)	Final Target (2030 & Beyond) (lb/MWh)
WY	1,808	1,714
UT*	1,378	1,322
OR	407	372
WA	264	215

*EPA’s calculation of the target for UT treated PacifiCorp’s Lakeside 2 NGCC plant as an existing resource. The emission rate assumed for UT assumes Lake Side 2 is correctly classified as “under construction”.

The 111(d) compliance strategy implemented for this case is summarized as follows:

- Flexible allocation of system renewable resources and flexible allocation of cumulative energy efficiency savings beginning 2017 from ID and CA, where PacifiCorp does not own fossil generation.
- Cumulative cost-effective selection of energy efficiency beginning 2017.
- New NGCC generation in WY and UT (new NGCC resources are not allowed in OR, WA, and ID).
- Re-dispatch of existing fossil generation, as required.
- Addition of new renewable resources, as required.

Forward Price Curve

Case C05a-2 gas and power prices reflect medium natural gas prices and regional compliance with EPA’s proposed 111(d) rule as implemented in the Company’s September 2014 official forward price curve (OFPC).

Nominal Average Annual Henry Hub Gas Prices

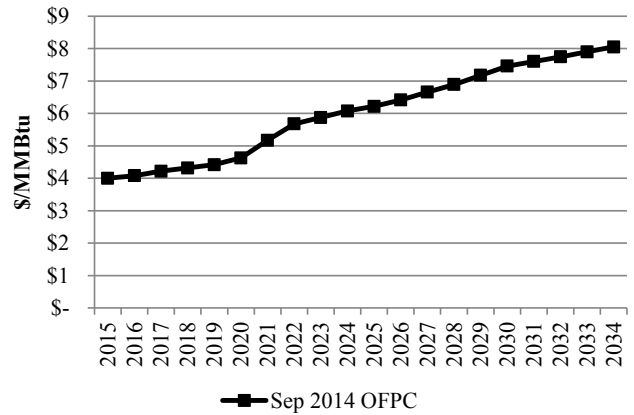

Nominal Average Annual Power Prices (Flat)

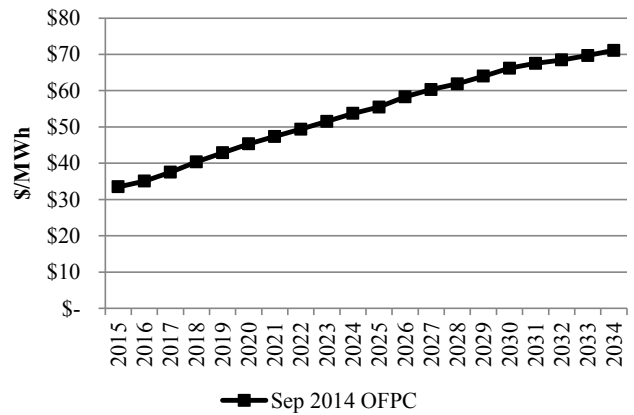

Regional Haze

Case C05a-2 reflects Regional Haze Scenario 2, which assumes inter-temporal and fleet trade-off Regional Haze compliance outcomes as shown in the table below. This scenario is for planning purposes recognizing that agency, regulator, and joint owner perspectives on acceptability have not been determined.

Coal Unit	Description
Carbon 1	Shut Down Apr 2015
Carbon 2	Shut Down Apr 2015
Cholla 4	Conversion by Jun 2025
Colstrip 3	SCR by Dec 2023
Colstrip 4	SCR by Dec 2022
Craig 1	SCR by Aug 2021
Craig 2	SCR by Jan 2018
Dave Johnson 1	Shut Down Mar 2019
Dave Johnson 2	Shut Down Dec 2023
Dave Johnson 3	Shut Down Dec 2027
Dave Johnson 4	Shut Down Dec 2032
Hayden 1	SCR by Jun 2015
Hayden 2	SCR by Jun 2016
Hunter 1	SCR by Dec 2021
Hunter 2	Shut Down Dec 2024
Hunter 3	SCR by Dec 2024
Huntington 1	Shut Down Dec 2024

Case: C05a-2

Coal Unit	Description
Huntington 2	Shut Down by Dec 2021
Jim Bridger 1	Shut Down by Dec 2023
Jim Bridger 2	Shut Down by Dec 2028
Jim Bridger 3	SCR by Dec 2015
Jim Bridger 4	SCR by Dec 2016
Naughton 1	Shut Down by Dec 2029
Naughton 2	Shut Down by Dec 2029
Naughton 3	Conversion by Jun 2018; Shut Down by Dec 2029
Wyodak	Shut Down by Dec 2032

*SCR = selective catalytic reduction

Federal Tax Incentives

- PTCs expire end of 2013
- ITC of 30% expire end of 2016, thereafter it continues in perpetuity at 10%.

Load Forecast

The figure below shows the medium system coincident peak load forecast applicable to this case before accounting for any potential contribution from DSM or distributed generation resources.

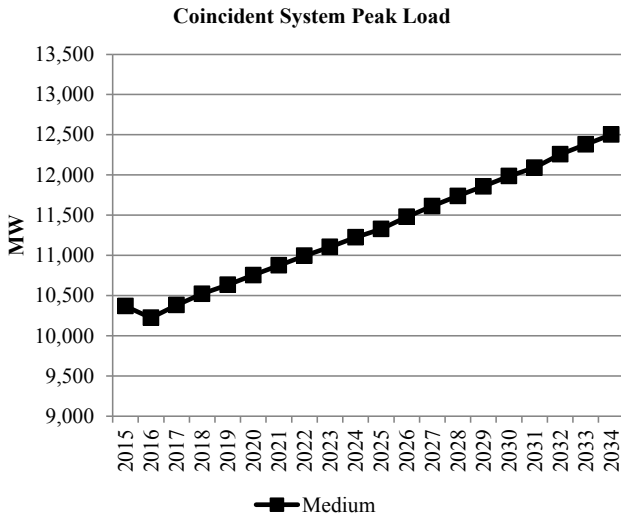

Energy Efficiency (Class 2 DSM)

This case uses base supply curves with economic resource selections up to the achievable potential. Class 2 resources that are not selected in any given year are not available for selection in future years. Achievable potential by state and year are summarized in the following figure.

Class 2 DSM Cumulative Achievable Potential

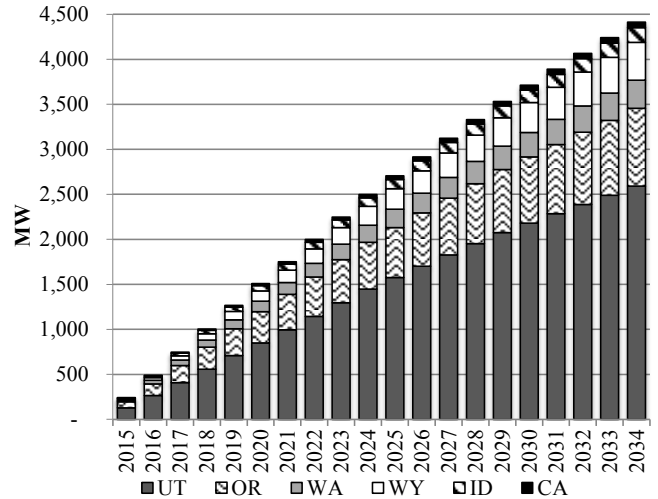

Distributed Generation

Base case distributed generation penetration is assumed in all states. Distributed generation by state and year are summarized below.

Distributed Generation - Base Penetration Case

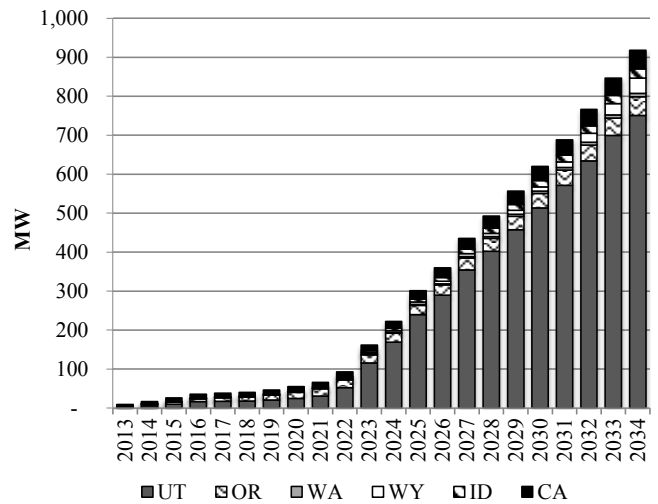

PORTFOLIO SUMMARY

System Optimizer PVRR (\$m)

System Cost without Transmission Upgrades	\$27,190
Transmission Integration	\$41
Transmission Reinforcement	\$10
Total Cost	\$27,240

Resource Portfolio

Cumulative changes to the resource portfolio (new resource additions and resource retirements), represented as nameplate capacity, are summarized in the figure below.

Case: C05a-2

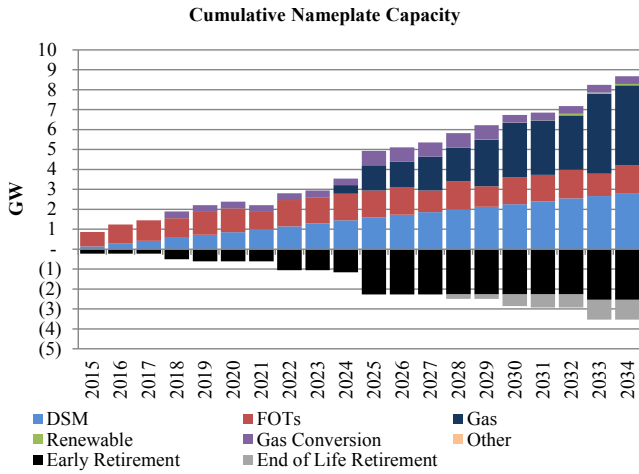

System CO₂ Emissions (System Optimizer)

System CO₂ emissions from System Optimizer are shown alongside those from Cases C01-R and C01-2 in the figure below.

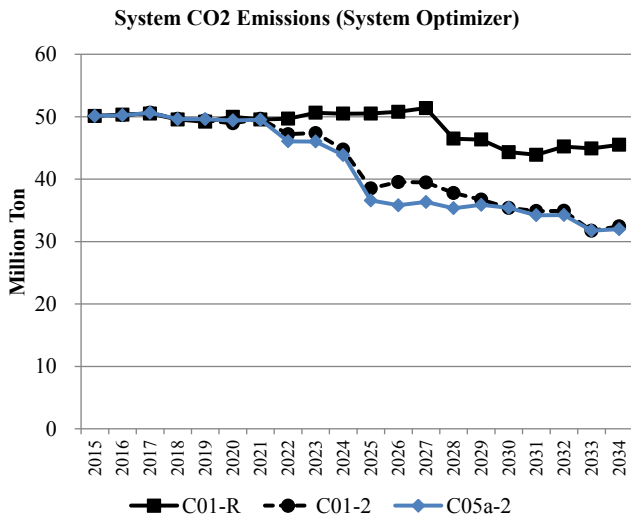

111(d) Compliance Profiles

The following figures summarize how compliance with state emission rate goals is achieved. The sum of each stacked bar represents the fossil emission rate. The net final rate represents the fossil rate after accounting for the emission rate impacts of new thermal (new NGCC units or nuclear, as applicable), re-dispatch of fossil units, energy efficiency (EE), and allocated renewable energy (RE).

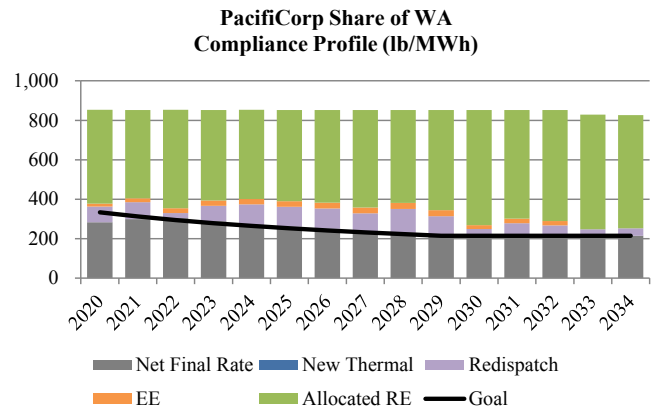
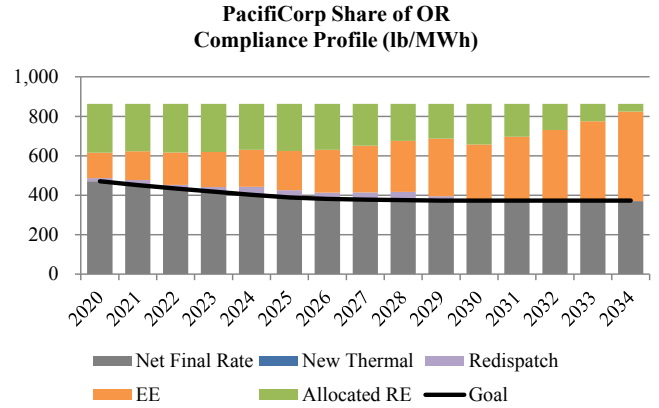
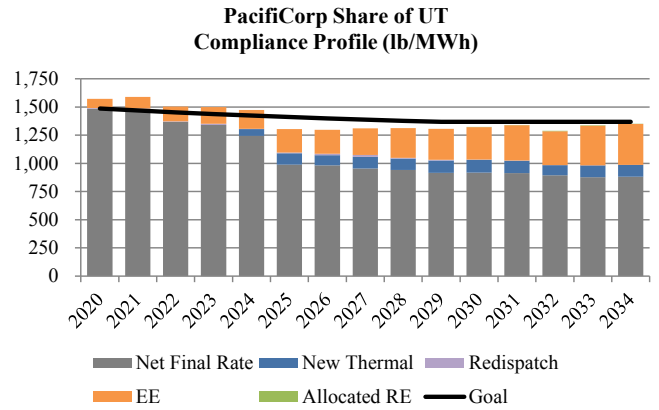
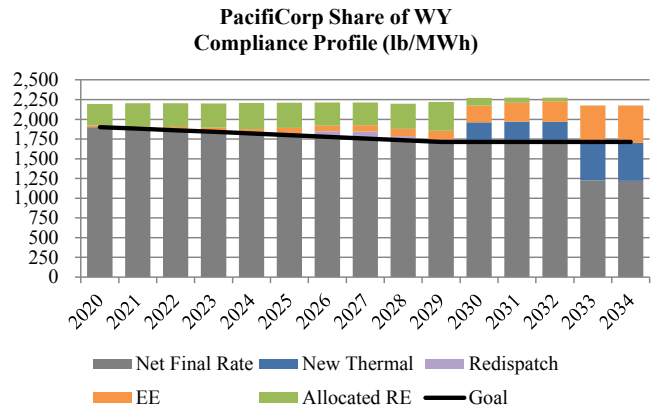

CASE ASSUMPTIONS

Description

Case C05a-3 is an alternative to Cases C05a-1 and C05a-2 that assumes future Oregon RPS requirements can be deferred with acquisition of unbundled Renewable Energy Credits (RECs) in the 2015-2019 timeframe and under a different assumption for assumed Regional Haze compliance outcomes. The case produces a portfolio that meets PacifiCorp’s share of state 111(d) emission rate goals in all states in which PacifiCorp has fossil generation and retail customers. The compliance strategy applied to this case relies on flexible allocation of renewable energy and energy efficiency while prioritizing re-dispatch of fossil generation to achieve incremental emission rate reductions as required. For planning purposes, this case assumes an alternative to the two Regional Haze compliance scenarios reflecting potential inter-temporal and fleet trade-off compliance outcomes.

Federal CO₂ Policy/Price Signal

C05a-3 reflects EPA’s proposed 111(d) rule with no additional CO₂ price signal. The table below summarizes the interim emission rate goal and the final emission rate target by state assumed to apply to PacifiCorp’s system.

State	Interim Goal (Avg. 2020-2029) (lb/MWh)	Final Target (2030 & Beyond) (lb/MWh)
WY	1,808	1,714
UT*	1,378	1,322
OR	407	372
WA	264	215

*EPA’s calculation of the target for UT treated PacifiCorp’s Lakeside 2 NGCC plant as an existing resource. The emission rate assumed for UT assumes Lake Side 2 is correctly classified as “under construction”.

The 111(d) compliance strategy implemented for this case is summarized as follows:

- Flexible allocation of system renewable resources and flexible allocation of cumulative energy efficiency savings beginning 2017 from ID and CA, where PacifiCorp does not own fossil generation.
- Cumulative cost-effective selection of energy efficiency beginning 2017.
- New NGCC generation in WY and UT (new NGCC resources are not allowed in OR, WA, and ID).
- Re-dispatch of existing fossil generation, as required.
- Addition of new renewable resources, as required.

Forward Price Curve

Case C05a-3 gas and power prices reflect medium natural gas prices and regional compliance with EPA’s proposed 111(d) rule as implemented in the Company’s September 2014 official forward price curve (OFPC).

Nominal Average Annual Henry Hub Gas Prices

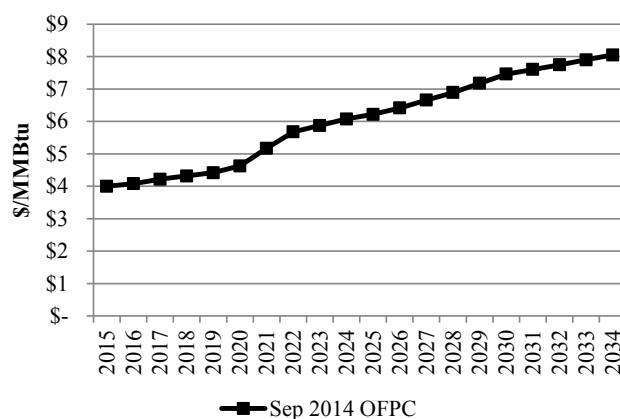

Nominal Average Annual Power Prices (Flat)

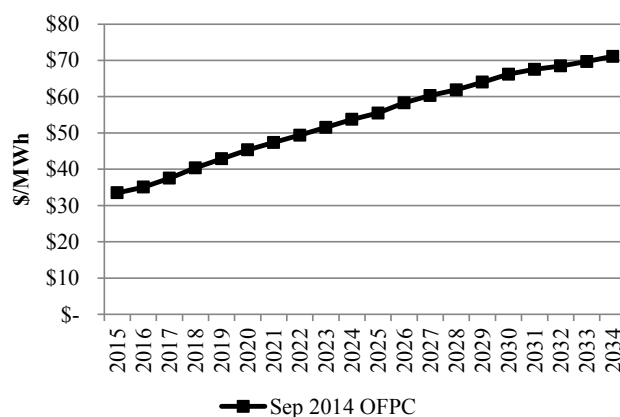

Regional Haze

Case C05a-3 reflects an alternative to Regional Haze Scenario 1, which assumes inter-temporal and fleet trade-off Regional Haze compliance outcomes as shown in the table below. This scenario is for planning purposes recognizing that agency, regulator, and joint owner perspectives on acceptability have not been determined.

Coal Unit	Description
Carbon 1	Shut Down Apr 2015
Carbon 2	Shut Down Apr 2015
Cholla 4	Conversion by Jun 2025
Colstrip 3	SCR by Dec 2023
Colstrip 4	SCR by Dec 2022
Craig 1	SCR by Aug 2021
Craig 2	SCR by Jan 2018
Dave Johnson 1	Shut Down Dec 2027
Dave Johnson 2	Shut Down Dec 2027
Dave Johnson 3	Shut Down Dec 2027
Dave Johnson 4	Shut Down Dec 2027
Hayden 1	SCR by Jun 2015
Hayden 2	SCR by Jun 2016
Hunter 1	SCR by Dec 2021
Hunter 2	Shut Down Dec 2032
Hunter 3	SCR by Dec 2024
Huntington 1	SCR by Dec 2022

Case: C05a-3

Coal Unit	Description
Huntington 2	Shut Down by Dec 2029
Jim Bridger 1	SCR by Dec 2022
Jim Bridger 2	SCR by Dec 2021
Jim Bridger 3	SCR by Dec 2015
Jim Bridger 4	SCR by Dec 2016
Naughton 1	Shut Down by Dec 2029
Naughton 2	Shut Down by Dec 2029
Naughton 3	Conversion by Jun 2018; Shut Down by Dec 2029
Wyodak	Shut Down by Dec 2039

*SCR = selective catalytic reduction

Federal Tax Incentives

- PTCs expire end of 2013
- ITC of 30% expire end of 2016, thereafter it continues in perpetuity at 10%.

Load Forecast

The figure below shows the medium system coincident peak load forecast applicable to this case before accounting for any potential contribution from DSM or distributed generation resources.

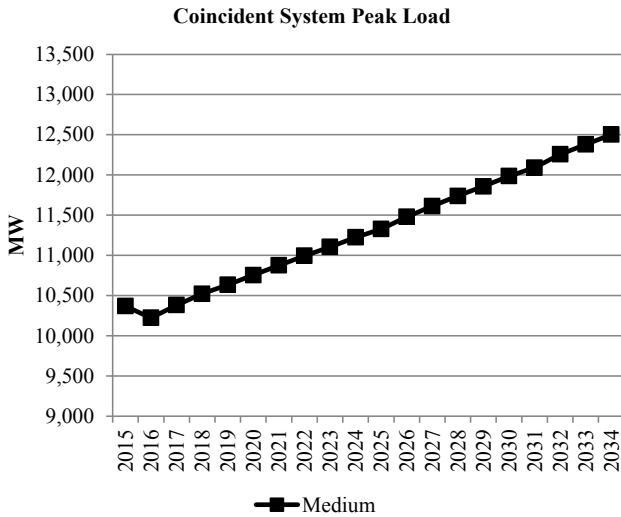

Energy Efficiency (Class 2 DSM)

This case uses base supply curves with economic resource selections up to the achievable potential. Class 2 resources that are not selected in any given year are not available for selection in future years. Achievable potential by state and year are summarized in the following figure.

Class 2 DSM Cumulative Achievable Potential

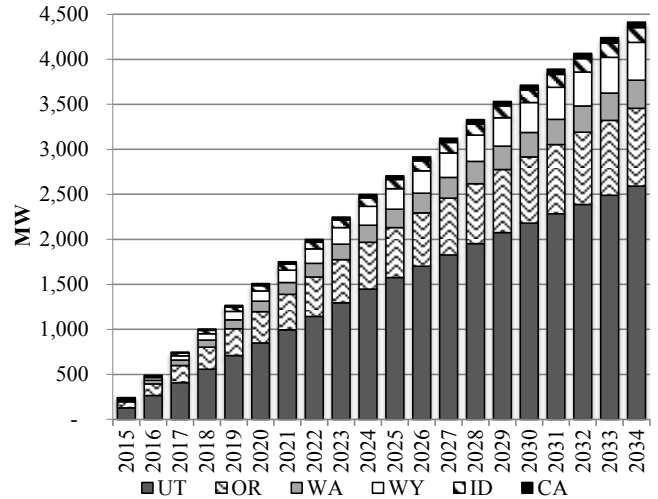

Distributed Generation

Base case distributed generation penetration is assumed in all states. Distributed generation by state and year are summarized below.

Distributed Generation - Base Penetration Case

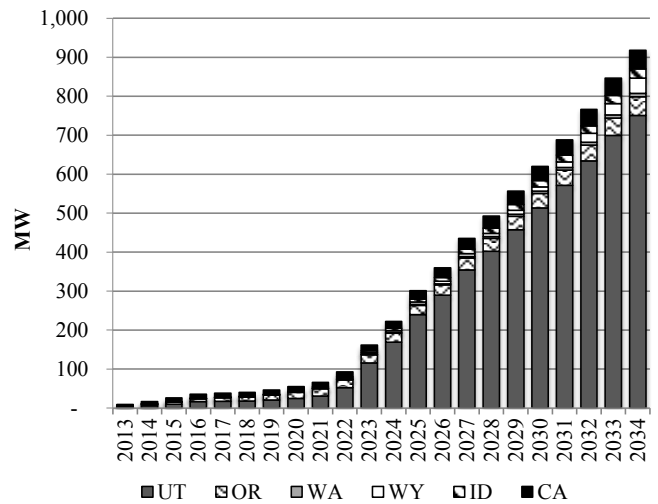

PORTFOLIO SUMMARY

System Optimizer PVRR (\$m)

System Cost without Transmission Upgrades	\$26,560
Transmission Integration	\$11
Transmission Reinforcement	\$6
Total Cost	\$26,578

Resource Portfolio

Cumulative changes to the resource portfolio (new resource additions and resource retirements), represented as nameplate capacity, are summarized in the figure below.

Case: C05a-3

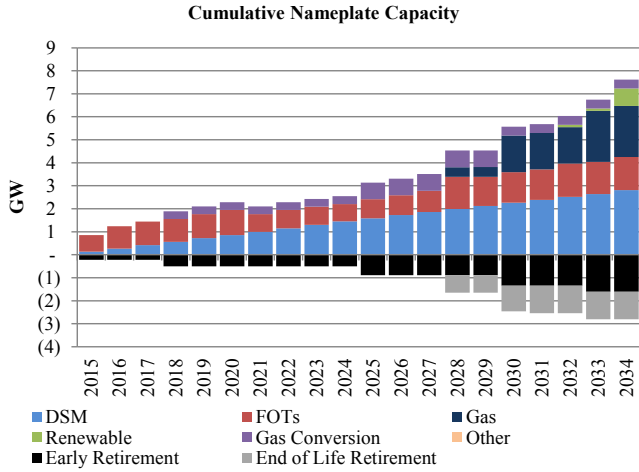

System CO₂ Emissions (System Optimizer)

System CO₂ emissions from System Optimizer are shown alongside those from Cases C01-R, C01-1, and C01-2 in the figure below.

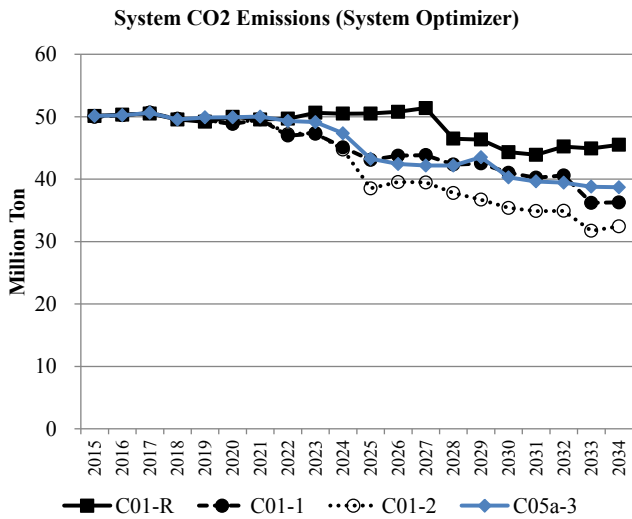

111(d) Compliance Profiles

The following figures summarize how compliance with state emission rate goals is achieved. The sum of each stacked bar represents the fossil emission rate. The net final rate represents the fossil rate after accounting for the emission rate impacts of new thermal (new NGCC units or nuclear, as applicable), re-dispatch of fossil units, energy efficiency (EE), and allocated renewable energy (RE).

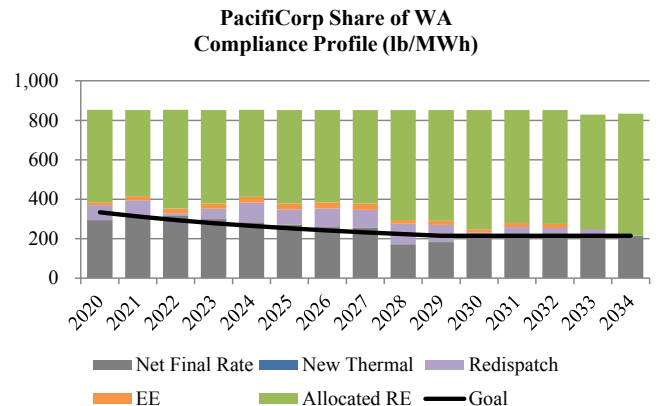
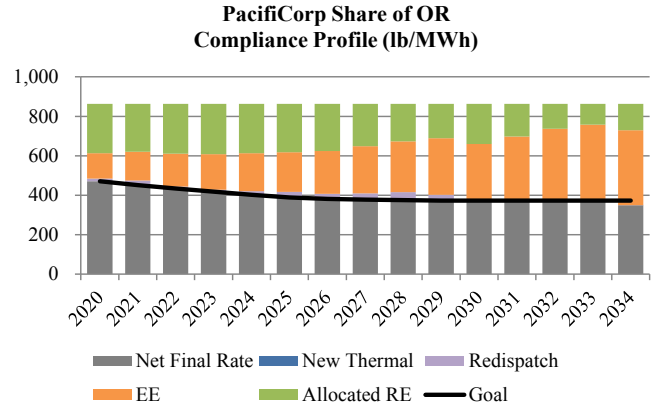
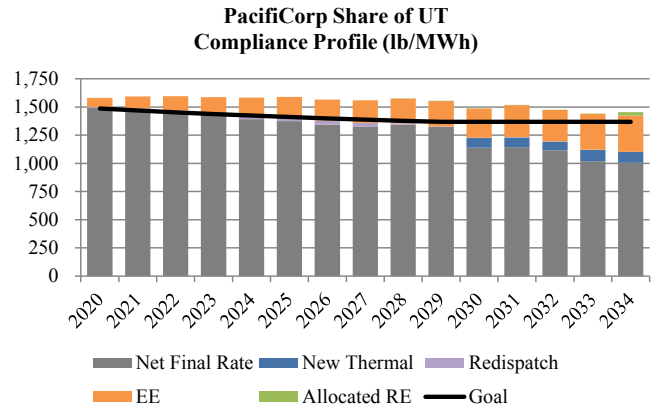
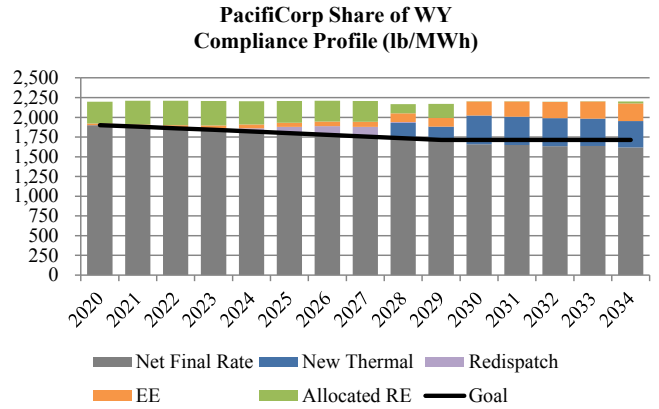

CASE ASSUMPTIONS

Description

Case C05a-3Q is an alternative to Cases C05a-3 that incorporates the most current information on executed QF contracts. This case assumes future Oregon RPS requirements can be deferred with acquisition of unbundled Renewable Energy Credits (RECs) in the 2015-2019 timeframe and under a different assumption for assumed Regional Haze compliance outcomes. The case produces a portfolio that meets PacifiCorp’s share of state 111(d) emission rate goals in all states in which PacifiCorp has fossil generation and retail customers. The compliance strategy applied to this case relies on flexible allocation of renewable energy and energy efficiency while prioritizing re-dispatch of fossil generation to achieve incremental emission rate reductions as required. For planning purposes, this case assumes an alternative to the two Regional Haze compliance scenarios reflecting potential inter-temporal and fleet trade-off compliance outcomes.

Federal CO₂ Policy/Price Signal

C05a-3Q reflects EPA’s proposed 111(d) rule with no additional CO₂ price signal. The table below summarizes the interim emission rate goal and the final emission rate target by state assumed to apply to PacifiCorp’s system.

State	Interim Goal (Avg. 2020-2029) (lb/MWh)	Final Target (2030 & Beyond) (lb/MWh)
WY	1,808	1,714
UT*	1,378	1,322
OR	407	372
WA	264	215

*EPA’s calculation of the target for UT treated PacifiCorp’s Lakeside 2 NGCC plant as an existing resource. The emission rate assumed for UT assumes Lake Side 2 is correctly classified as “under construction”.

The 111(d) compliance strategy implemented for this case is summarized as follows:

- Flexible allocation of system renewable resources and flexible allocation of cumulative energy efficiency savings beginning 2017 from ID and CA, where PacifiCorp does not own fossil generation.
- Cumulative cost-effective selection of energy efficiency beginning 2017.
- New NGCC generation in WY and UT (new NGCC resources are not allowed in OR, WA, and ID).
- Re-dispatch of existing fossil generation, as required.
- Addition of new renewable resources, as required.

Forward Price Curve

Case C05a-3Q gas and power prices reflect medium natural gas prices and regional compliance with EPA’s proposed 111(d) rule as implemented in the Company’s September 2014 official forward price curve (OFPC).

Nominal Average Annual Henry Hub Gas Prices

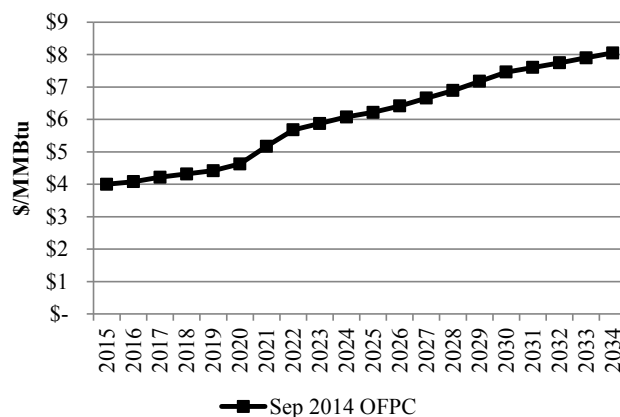

Nominal Average Annual Power Prices (Flat)

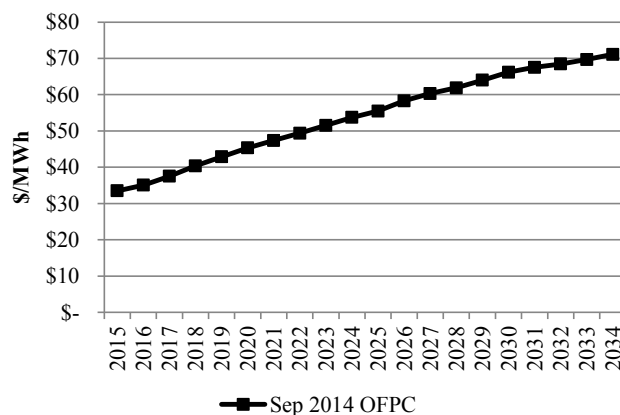

Regional Haze

Case C05a-3Q reflects an alternative to Regional Haze Scenarios 1 and 2, which assumes inter-temporal and fleet trade-off Regional Haze compliance outcomes as shown in the table below. This scenario is for planning purposes recognizing that agency, regulator, and joint owner perspectives on acceptability have not been determined.

Coal Unit	Description
Carbon 1	Shut Down Apr 2015
Carbon 2	Shut Down Apr 2015
Cholla 4	Conversion by Jun 2025
Colstrip 3	SCR by Dec 2023
Colstrip 4	SCR by Dec 2022
Craig 1	SCR by Aug 2021
Craig 2	SCR by Jan 2018
Dave Johnson 1	Shut Down Dec 2027
Dave Johnson 2	Shut Down Dec 2027
Dave Johnson 3	Shut Down Dec 2027
Dave Johnson 4	Shut Down Dec 2027
Hayden 1	SCR by Jun 2015
Hayden 2	SCR by Jun 2016
Hunter 1	SCR by Dec 2021
Hunter 2	Shut Down Dec 2032
Hunter 3	SCR by Dec 2024
Huntington 1	SCR by Dec 2022

Case: C05a-3Q

Coal Unit	Description
Huntington 2	Shut Down by Dec 2029
Jim Bridger 1	SCR by Dec 2022
Jim Bridger 2	SCR by Dec 2021
Jim Bridger 3	SCR by Dec 2015
Jim Bridger 4	SCR by Dec 2016
Naughton 1	Shut Down by Dec 2029
Naughton 2	Shut Down by Dec 2029
Naughton 3	Conversion by Jun 2018; Shut Down by Dec 2029
Wyodak	Shut Down by Dec 2039

*SCR = selective catalytic reduction

Federal Tax Incentives

- PTCs expire end of 2013
- ITC of 30% expire end of 2016, thereafter it continues in perpetuity at 10%.

Load Forecast

The figure below shows the medium system coincident peak load forecast applicable to this case before accounting for any potential contribution from DSM or distributed generation resources.

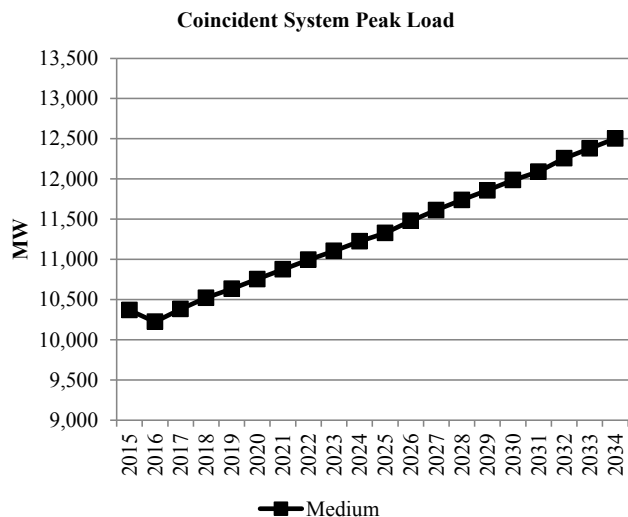

Energy Efficiency (Class 2 DSM)

This case uses base supply curves with economic resource selections up to the achievable potential. Class 2 resources that are not selected in any given year are not available for selection in future years. Achievable potential by state and year are summarized in the following figure.

Class 2 DSM Cumulative Achievable Potential

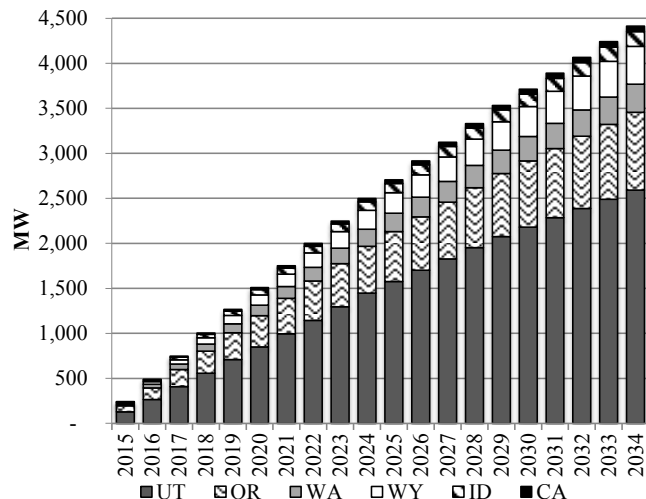

Distributed Generation

Base case distributed generation penetration is assumed in all states. Distributed generation by state and year are summarized below.

Distributed Generation - Base Penetration Case

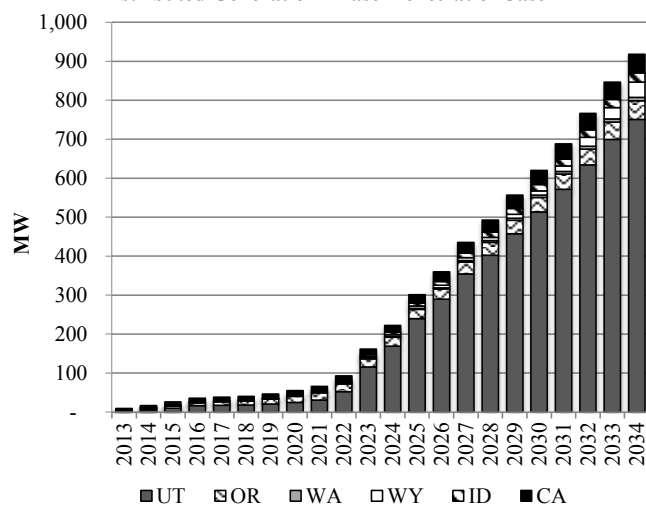

PORTFOLIO SUMMARY

System Optimizer PVRR (\$m)

System Cost without Transmission Upgrades	\$26,570
Transmission Integration	\$14
Transmission Reinforcement	\$6
Total Cost	\$26,591

Resource Portfolio

Cumulative changes to the resource portfolio (new resource additions and resource retirements), represented as nameplate capacity, are summarized in the figure below.

Case: C05a-3Q

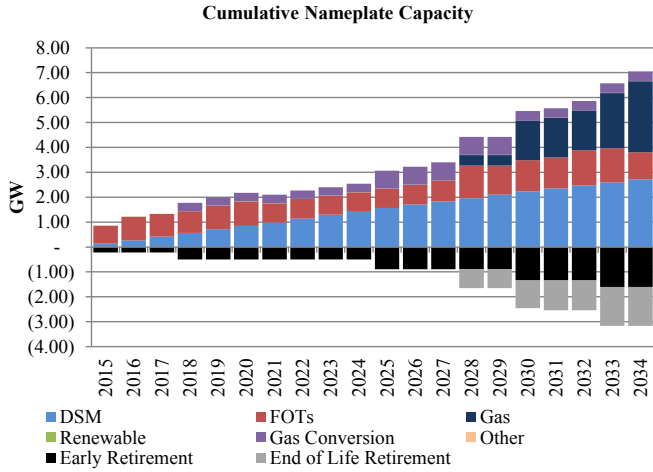

System CO₂ Emissions (System Optimizer)

System CO₂ emissions from System Optimizer are shown alongside those from Cases C01-R, C01-1, and C01-2 in the figure below.

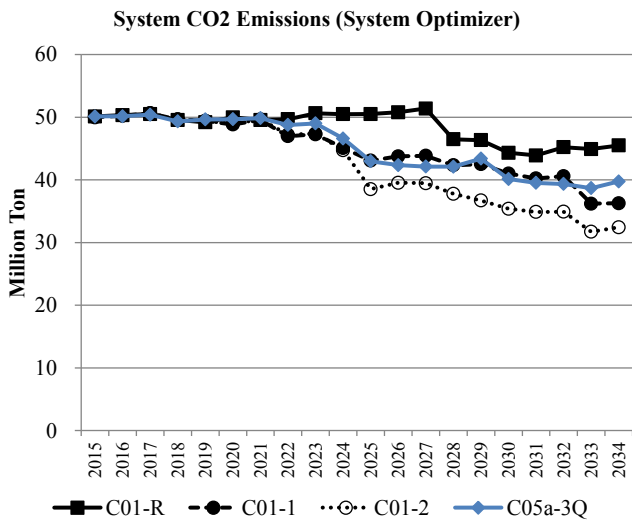

111(d) Compliance Profiles

The following figures summarize how compliance with state emission rate goals is achieved. The sum of each stacked bar represents the fossil emission rate. The net final rate represents the fossil rate after accounting for the emission rate impacts of new thermal (new NGCC units or nuclear, as applicable), re-dispatch of fossil units, energy efficiency (EE), and allocated renewable energy (RE).

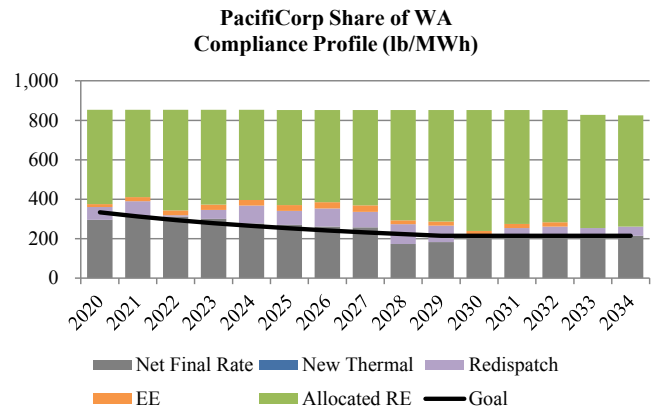
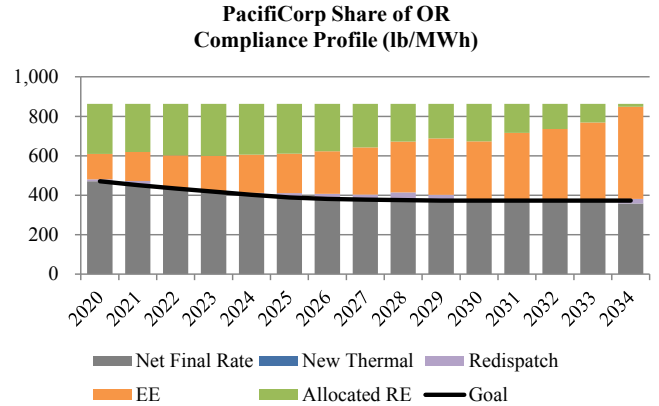
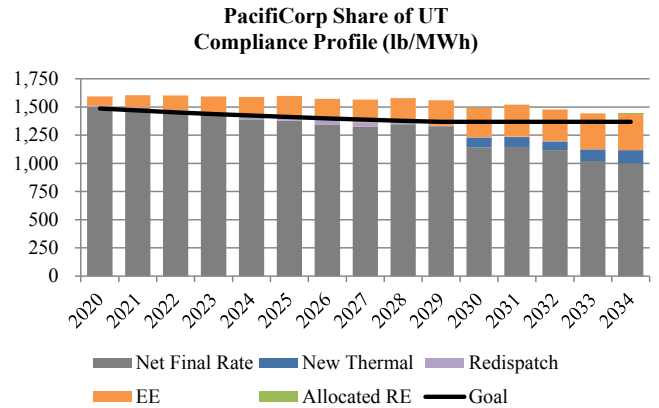
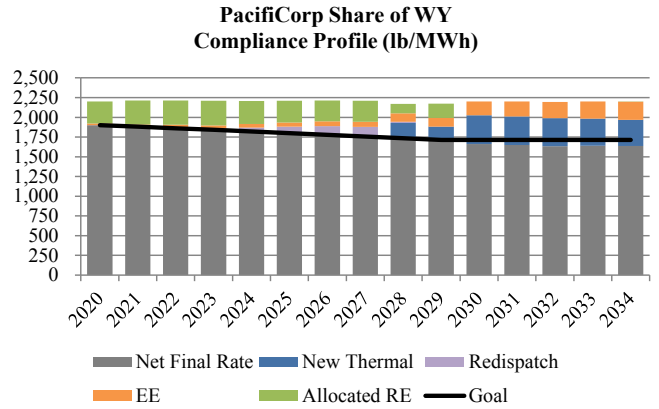

CASE ASSUMPTIONS

Description

Case C05b-3 is an alternative to Case C05a-3 that delays building resources to meet Oregon RPS requirements until the balance of banked RECs is exhausted. This results in resource additions in 2028 to meet state requirements. The case produces a portfolio that meets PacifiCorp’s share of state 111(d) emission rate goals in all states in which PacifiCorp has fossil generation and retail customers. The compliance strategy applied to this case relies on flexible allocation of renewable energy and energy efficiency while prioritizing re-dispatch of fossil generation to achieve incremental emission rate reductions as required. For planning purposes, this case assumes an alternative to the two Regional Haze compliance scenarios reflecting potential inter-temporal and fleet trade-off compliance outcomes.

Federal CO₂ Policy/Price Signal

C05a-3 reflects EPA’s proposed 111(d) rule with no additional CO₂ price signal. The table below summarizes the interim emission rate goal and the final emission rate target by state assumed to apply to PacifiCorp’s system.

State	Interim Goal (Avg. 2020-2029) (lb/MWh)	Final Target (2030 & Beyond) (lb/MWh)
WY	1,808	1,714
UT*	1,378	1,322
OR	407	372
WA	264	215

*EPA’s calculation of the target for UT treated PacifiCorp’s Lakeside 2 NGCC plant as an existing resource. The emission rate assumed for UT assumes Lake Side 2 is correctly classified as “under construction”.

The 111(d) compliance strategy implemented for this case is summarized as follows:

- Flexible allocation of system renewable resources and flexible allocation of cumulative energy efficiency savings beginning 2017 from ID and CA, where PacifiCorp does not own fossil generation.
- Cumulative cost-effective selection of energy efficiency beginning 2017.
- New NGCC generation in WY and UT (new NGCC resources are not allowed in OR, WA, and ID).
- Re-dispatch of existing fossil generation, as required.
- Addition of new renewable resources, as required.

Forward Price Curve

Case C05b-3 gas and power prices reflect medium natural gas prices and regional compliance with EPA’s proposed 111(d) rule as implemented in the Company’s September 2014 official forward price curve (OFPC).

Nominal Average Annual Henry Hub Gas Prices

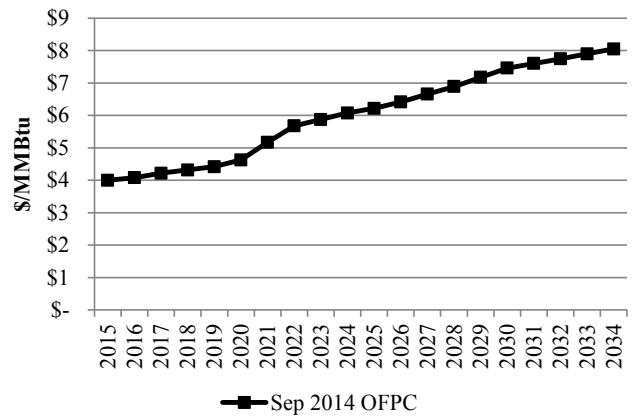

Nominal Average Annual Power Prices (Flat)

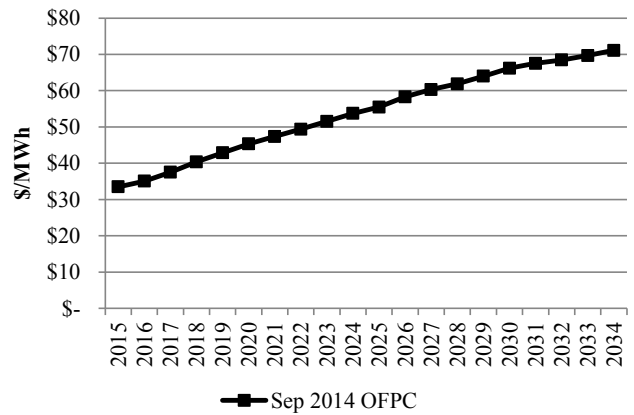

Regional Haze

Case C05b-3 reflects an alternative to Regional Haze Scenario 1, which assumes inter-temporal and fleet trade-off Regional Haze compliance outcomes as shown in the table below. This scenario is for planning purposes recognizing that agency, regulator, and joint owner perspectives on acceptability have not been determined.

Coal Unit	Description
Carbon 1	Shut Down Apr 2015
Carbon 2	Shut Down Apr 2015
Cholla 4	Conversion by Jun 2025
Colstrip 3	SCR by Dec 2023
Colstrip 4	SCR by Dec 2022
Craig 1	SCR by Aug 2021
Craig 2	SCR by Jan 2018
Dave Johnson 1	Shut Down Dec 2027
Dave Johnson 2	Shut Down Dec 2027
Dave Johnson 3	Shut Down Dec 2027
Dave Johnson 4	Shut Down Dec 2027
Hayden 1	SCR by Jun 2015
Hayden 2	SCR by Jun 2016
Hunter 1	SCR by Dec 2021
Hunter 2	Shut Down Dec 2032
Hunter 3	SCR by Dec 2024
Huntington 1	SCR by Dec 2022

Case: C05b-3

Coal Unit	Description
Huntington 2	Shut Down by Dec 2029
Jim Bridger 1	SCR by Dec 2022
Jim Bridger 2	SCR by Dec 2021
Jim Bridger 3	SCR by Dec 2015
Jim Bridger 4	SCR by Dec 2016
Naughton 1	Shut Down by Dec 2029
Naughton 2	Shut Down by Dec 2029
Naughton 3	Conversion by Jun 2018; Shut Down by Dec 2029
Wyodak	Shut Down by Dec 2039

*SCR = selective catalytic reduction

Federal Tax Incentives

- PTCs expire end of 2013
- ITC of 30% expire end of 2016, thereafter it continues in perpetuity at 10%.

Load Forecast

The figure below shows the medium system coincident peak load forecast applicable to this case before accounting for any potential contribution from DSM or distributed generation resources.

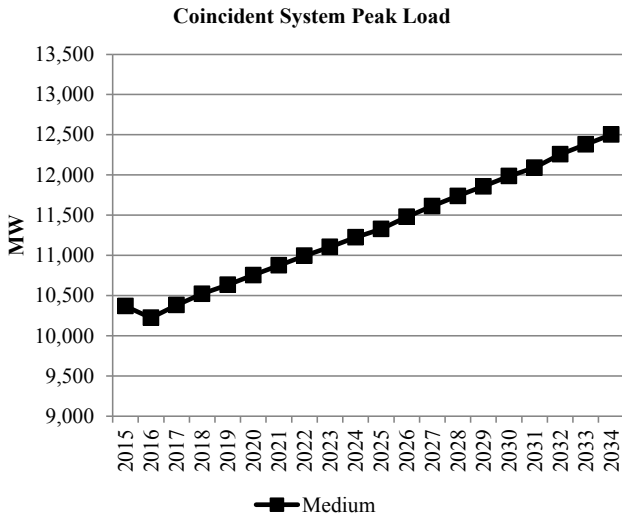

Energy Efficiency (Class 2 DSM)

This case uses base supply curves with economic resource selections up to the achievable potential. Class 2 resources that are not selected in any given year are not available for selection in future years. Achievable potential by state and year are summarized in the following figure.

Class 2 DSM Cumulative Achievable Potential

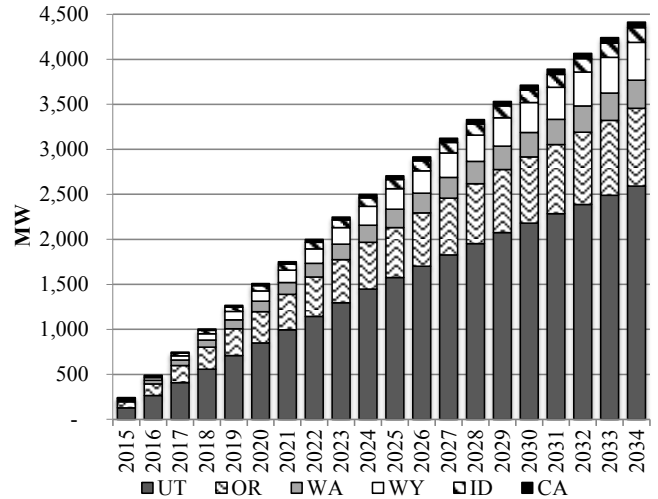

Distributed Generation

Base case distributed generation penetration is assumed in all states. Distributed generation by state and year are summarized below.

Distributed Generation - Base Penetration Case

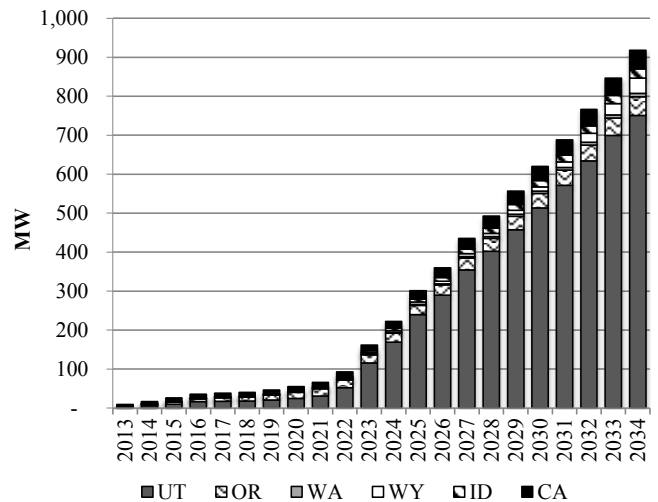

PORTFOLIO SUMMARY

System Optimizer PVRR (\$m)

System Cost without Transmission Upgrades	\$26,604
Transmission Integration	\$38
Transmission Reinforcement	\$6
Total Cost	\$26,649

Resource Portfolio

Cumulative changes to the resource portfolio (new resource additions and resource retirements), represented as nameplate capacity, are summarized in the figure below.

Case: C05b-3

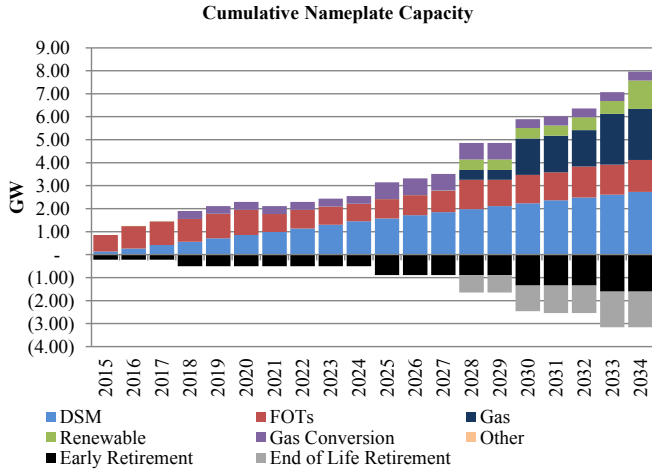

System CO₂ Emissions (System Optimizer)

System CO₂ emissions from System Optimizer are shown alongside those from Cases C01-R, C01-1, and C01-2 in the figure below.

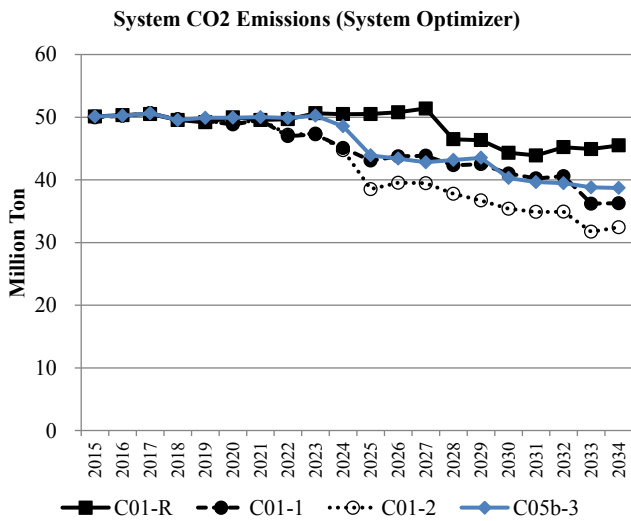

111(d) Compliance Profiles

The following figures summarize how compliance with state emission rate goals is achieved. The sum of each stacked bar represents the fossil emission rate. The net final rate represents the fossil rate after accounting for the emission rate impacts of new thermal (new NGCC units or nuclear, as applicable), re-dispatch of fossil units, energy efficiency (EE), and allocated renewable energy (RE).

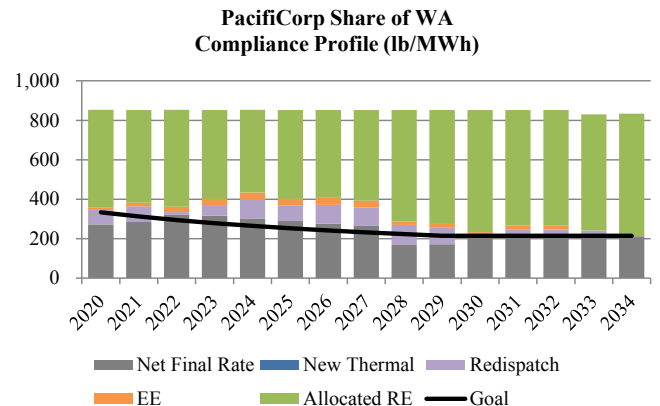
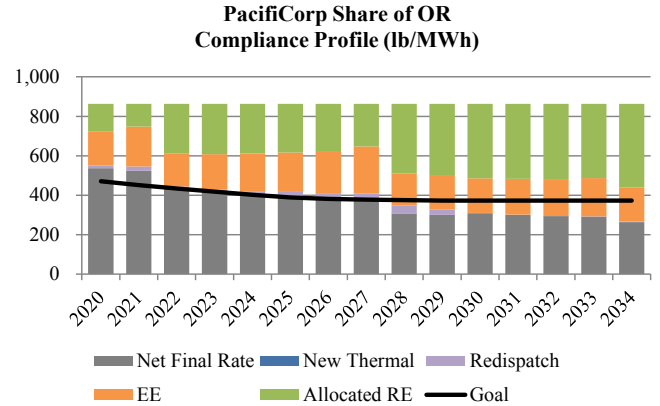
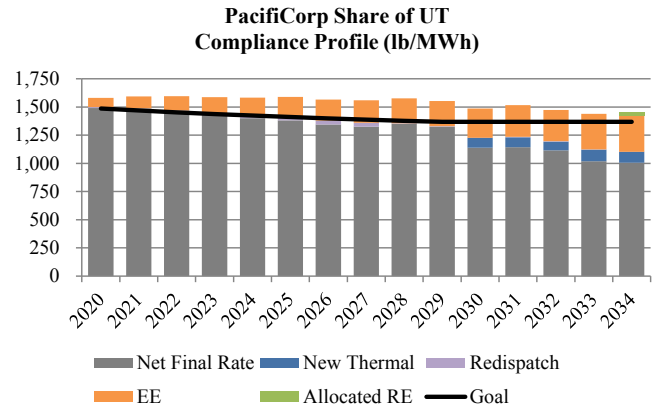
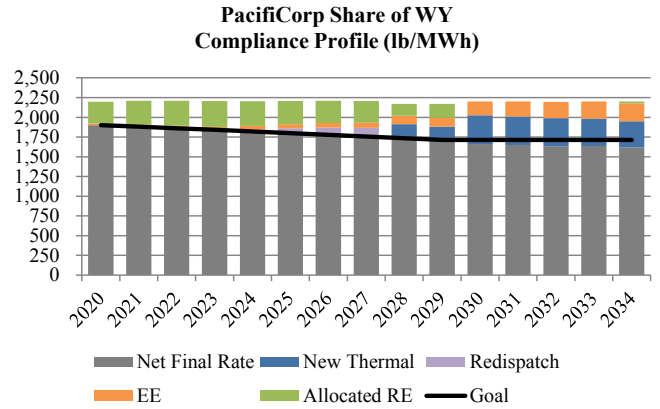

CASE ASSUMPTIONS

Description

Case C06-1 produces a portfolio that meets PacifiCorp’s share of state 111(d) emission rate goals in all states in which PacifiCorp has fossil generation and retail customers. The compliance strategy applied to this case relies on flexible allocation of renewable energy and energy efficiency, increased energy efficiency acquisition, and re-dispatch of fossil generation. New renewable resources are added after re-dispatch of fossil generation, as required. For planning purposes, this case assumes one of two different Regional Haze compliance scenarios reflecting potential inter-temporal and fleet trade-off compliance outcomes.

Federal CO₂ Policy/Price Signal

C06-1 reflects EPA’s proposed 111(d) rule with no additional CO₂ price signal. The table below summarizes the interim emission rate goal and the final emission rate target by state assumed to apply to PacifiCorp’s system.

State	Interim Goal (Avg. 2020-2029) (lb/MWh)	Final Target (2030 & Beyond) (lb/MWh)
WY	1,808	1,714
UT*	1,378	1,322
OR	407	372
WA	264	215

*EPA’s calculation of the target for UT treated PacifiCorp’s Lakeside 2 NGCC plant as an existing resource. The emission rate assumed for UT assumes Lake Side 2 is correctly classified as “under construction”.

The 111(d) compliance strategy implemented for this case is summarized as follows:

- Flexible allocation of system renewable resources and flexible allocation of cumulative energy efficiency savings beginning 2017 from ID and CA, where PacifiCorp does not own fossil generation.
- Cumulative selection of energy efficiency beginning 2017 up to 1.5% of retail sales.
- New NGCC generation in WY and UT (new NGCC resources are not allowed in OR, WA, and ID).
- Re-dispatch of existing fossil generation, as required.
- Addition of new renewable resources, as required.

Forward Price Curve

Case C06-1 gas and power prices reflect medium natural gas prices and regional compliance with EPA’s proposed 111(d) rule as implemented in the Company’s September 2014 official forward price curve (OFPC).

Nominal Average Annual Henry Hub Gas Prices

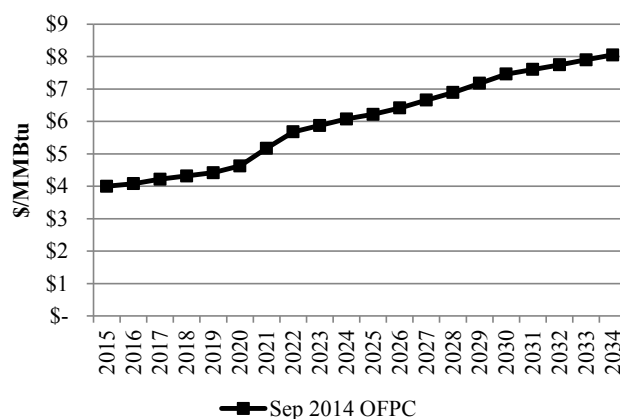

Nominal Average Annual Power Prices (Flat)

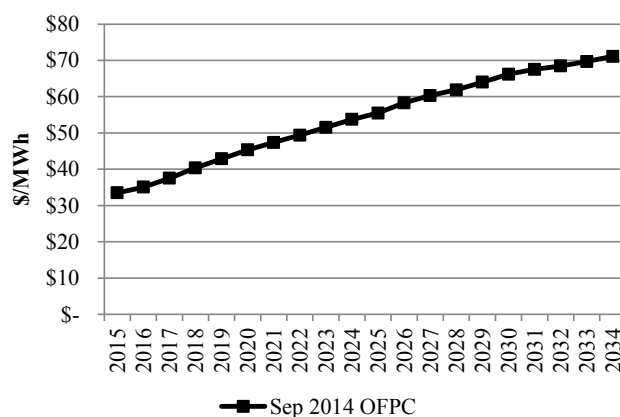

Regional Haze

Case C06-1 reflects Regional Haze Scenario 1, which assumes inter-temporal and fleet trade-off Regional Haze compliance outcomes as shown in the table below. This scenario is for planning purposes recognizing that agency, regulator, and joint owner perspectives on acceptability have not been determined.

Coal Unit	Description
Carbon 1	Shut Down Apr 2015
Carbon 2	Shut Down Apr 2015
Cholla 4	Conversion by Jun 2025
Colstrip 3	SCR by Dec 2023
Colstrip 4	SCR by Dec 2022
Craig 1	SCR by Aug 2021
Craig 2	SCR by Jan 2018
Dave Johnston 1	Shut Down Mar 2019
Dave Johnston 2	Shut Down Dec 2027
Dave Johnston 3	Shut Down Dec 2027
Dave Johnston 4	Shut Down Dec 2032
Hayden 1	SCR by Jun 2015
Hayden 2	SCR by Jun 2016
Hunter 1	SCR by Dec 2021
Hunter 2	Shut Down by Dec 2032
Hunter 3	SCR by Dec 2024
Huntington 1	Shut Down by Dec 2036

Case: C06-1

Coal Unit	Description
Huntington 2	Shut Down by Dec 2021
Jim Bridger 1	Shut Down by Dec 2023
Jim Bridger 2	Shut Down by Dec 2032
Jim Bridger 3	SCR by Dec 2015
Jim Bridger 4	SCR by Dec 2016
Naughton 1	Shut Down by Dec 2029
Naughton 2	Shut Down by Dec 2029
Naughton 3	Conversion by Jun 2018; Shut Down by Dec 2029
Wyodak	Shut Down by Dec 2039

* SCR = selective catalytic reduction

Federal Tax Incentives

- PTCs expire end of 2013
- ITC of 30% expire end of 2016, thereafter it continues in perpetuity at 10%.

Load Forecast

The figure below shows the medium system coincident peak load forecast applicable to this case before accounting for any potential contribution from DSM or distributed generation resources.

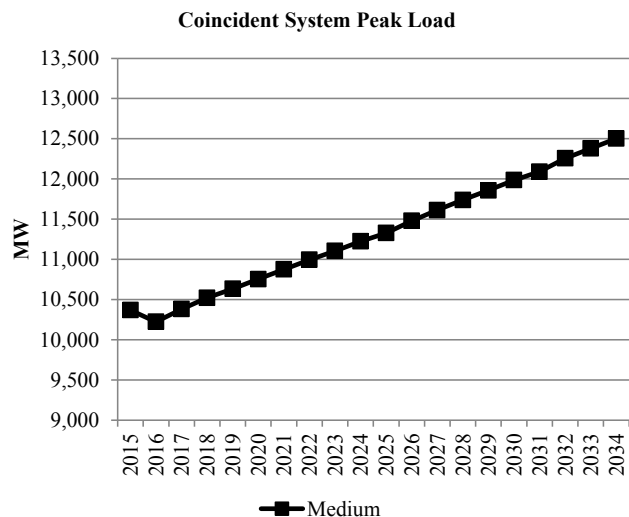

Energy Efficiency (Class 2 DSM)

This case uses base supply curves with economic resource selections up to the achievable potential. Additional energy efficiency beyond economic selections, up to 1.5% of retail sales, is forced into the resource portfolio. Class 2 resources that are not selected or forced in any given year are not available for selection in future years. Achievable potential by state and year are summarized in the following figure.

Class 2 DSM Cumulative Achievable Potential

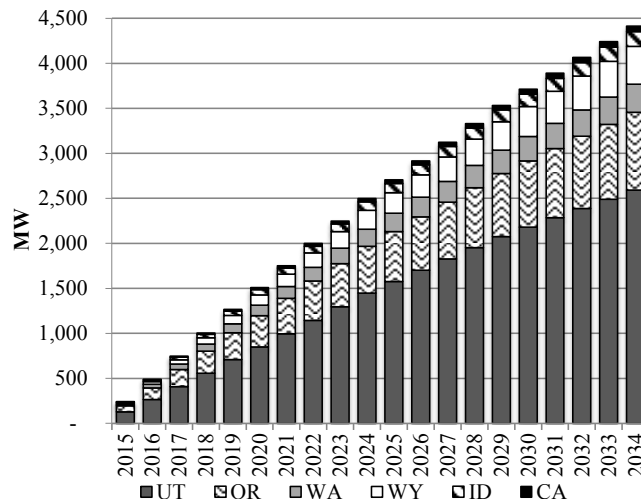

Distributed Generation

Base case distributed generation penetration is assumed in all states. Distributed generation by state and year are summarized below.

Distributed Generation - Base Penetration Case

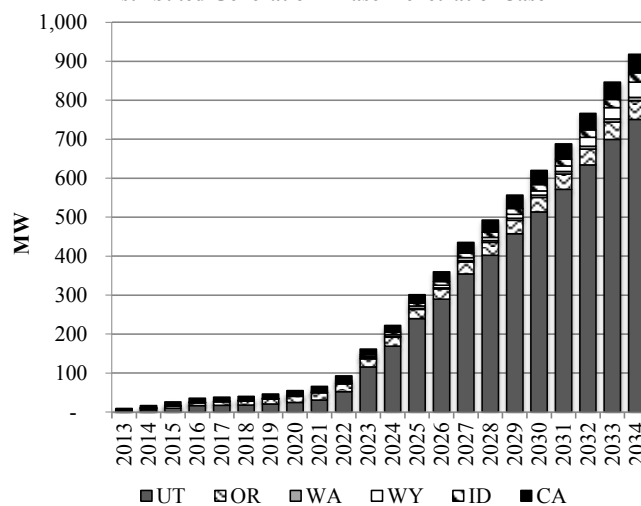

PORTFOLIO SUMMARY

System Optimizer PVRR (\$m)

System Cost without Transmission Upgrades	\$27,919
Transmission Integration	\$5
Transmission Reinforcement	\$6
Total Cost	\$27,930

Resource Portfolio

Cumulative changes to the resource portfolio (new resource additions and resource retirements), represented as nameplate capacity, are summarized in the figure below.

Case: C06-1

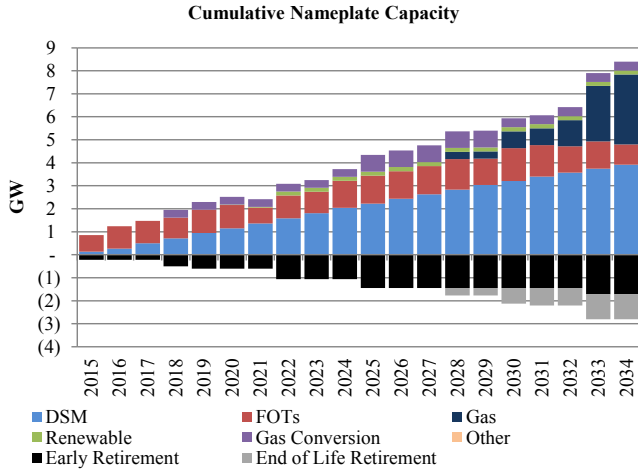

System CO₂ Emissions (System Optimizer)

System CO₂ emissions from System Optimizer are shown alongside those from Cases C01-R and C01-1 in the figure below.

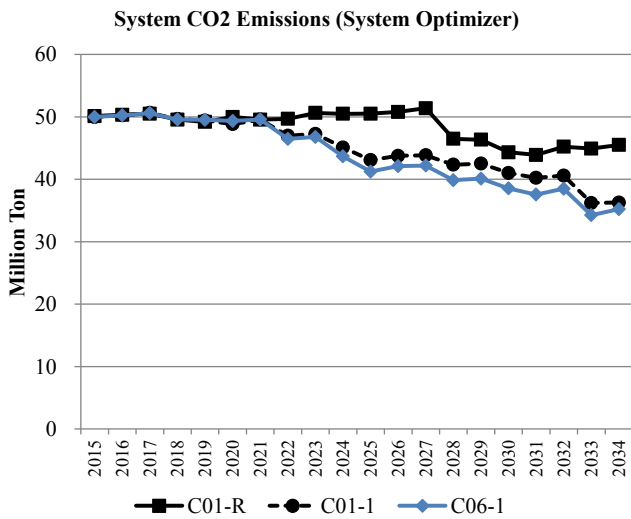

111(d) Compliance Profiles

The following figures summarize how compliance with state emission rate goals is achieved. The sum of each stacked bar represents the fossil emission rate. The net final rate represents the fossil rate after accounting for the emission rate impacts of new thermal (new NGCC units or nuclear, as applicable), re-dispatch of fossil units, energy efficiency (EE), and allocated renewable energy (RE).

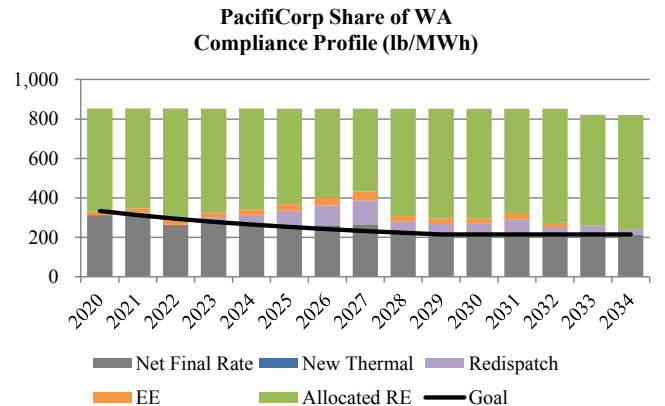
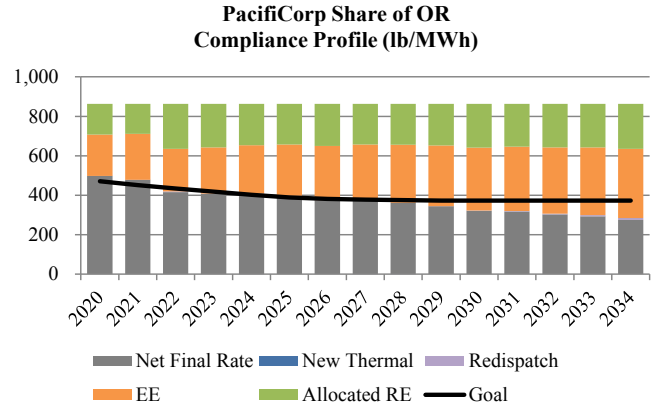
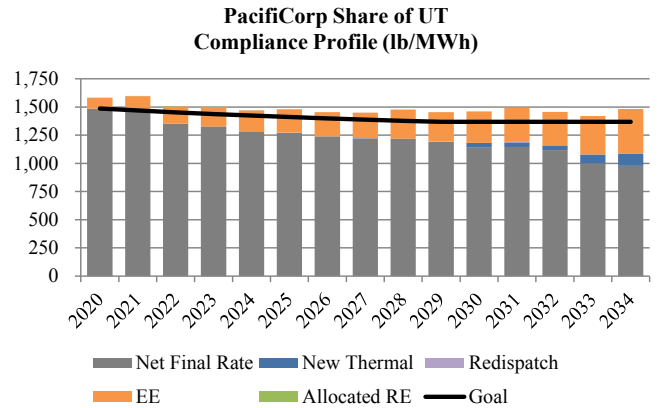
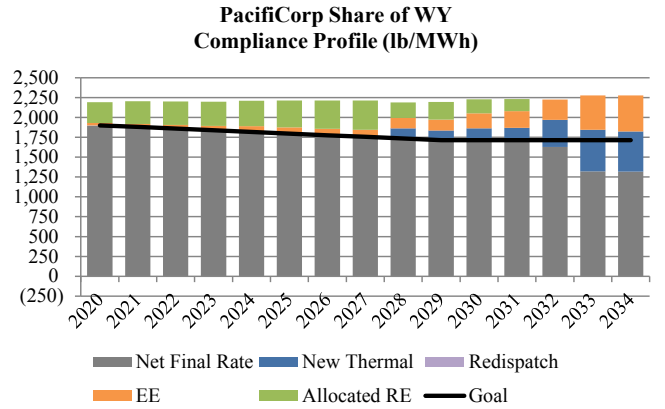

CASE ASSUMPTIONS

Description

Case C06-2 produces a portfolio that meets PacifiCorp’s share of state 111(d) emission rate goals in all states in which PacifiCorp has fossil generation and retail customers. The compliance strategy applied to this case relies on flexible allocation of renewable energy and energy efficiency, increased energy efficiency acquisition, and re-dispatch of fossil generation. New renewable resources are added after re-dispatch of fossil generation, as required. For planning purposes, this case assumes one of two different Regional Haze compliance scenarios reflecting potential inter-temporal and fleet trade-off compliance outcomes.

Federal CO₂ Policy/Price Signal

C06-2 reflects EPA’s proposed 111(d) rule with no additional CO₂ price signal. The table below summarizes the interim emission rate goal and the final emission rate target by state assumed to apply to PacifiCorp’s system.

State	Interim Goal (Avg. 2020-2029) (lb/MWh)	Final Target (2030 & Beyond) (lb/MWh)
WY	1,808	1,714
UT*	1,378	1,322
OR	407	372
WA	264	215

*EPA’s calculation of the target for UT treated PacifiCorp’s Lakeside 2 NGCC plant as an existing resource. The emission rate assumed for UT assumes Lake Side 2 is correctly classified as “under construction”.

The 111(d) compliance strategy implemented for this case is summarized as follows:

- Flexible allocation of system renewable resources and flexible allocation of cumulative energy efficiency savings beginning 2017 from ID and CA, where PacifiCorp does not own fossil generation.
- Cumulative selection of energy efficiency beginning 2017 up to 1.5% of retail sales.
- New NGCC generation in WY and UT (new NGCC resources are not allowed in OR, WA, and ID).
- Re-dispatch of existing fossil generation, as required.
- Addition of new renewable resources, as required.

Forward Price Curve

Case C06-2 gas and power prices reflect medium natural gas prices and regional compliance with EPA’s proposed 111(d) rule as implemented in the Company’s September 2014 official forward price curve (OFPC).

Nominal Average Annual Henry Hub Gas Prices

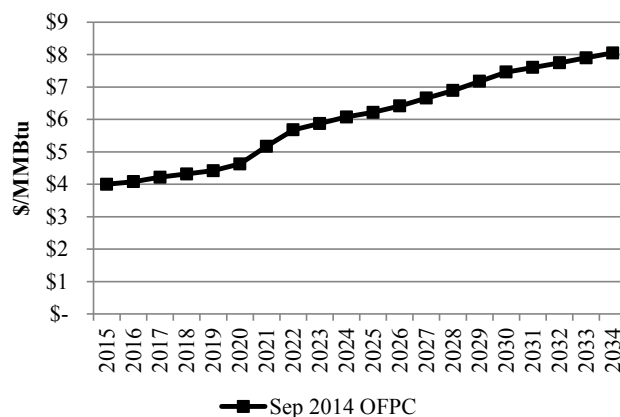

Nominal Average Annual Power Prices (Flat)

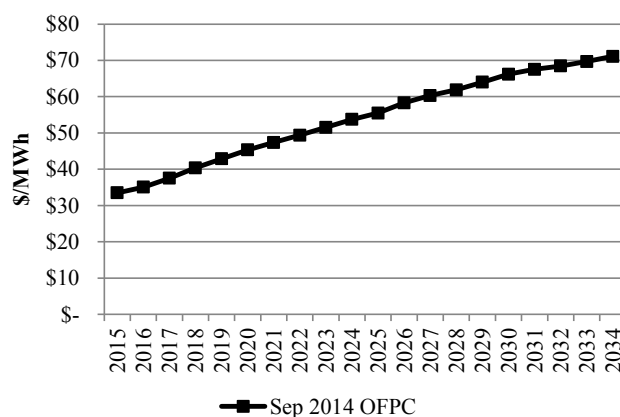

Regional Haze

Case C06-2 reflects Regional Haze Scenario 2, which assumes inter-temporal and fleet trade-off Regional Haze compliance outcomes as shown in the table below. This scenario is for planning purposes recognizing that agency, regulator, and joint owner perspectives on acceptability have not been determined.

Coal Unit	Description
Carbon 1	Shut Down Apr 2015
Carbon 2	Shut Down Apr 2015
Cholla 4	Conversion by Jun 2025
Colstrip 3	SCR by Dec 2023
Colstrip 4	SCR by Dec 2022
Craig 1	SCR by Aug 2021
Craig 2	SCR by Jan 2018
Dave Johnson 1	Shut Down Mar 2019
Dave Johnson 2	Shut Down Dec 2023
Dave Johnson 3	Shut Down Dec 2027
Dave Johnson 4	Shut Down Dec 2032
Hayden 1	SCR by Jun 2015
Hayden 2	SCR by Jun 2016
Hunter 1	SCR by Dec 2021
Hunter 2	Shut Down Dec 2024
Hunter 3	SCR by Dec 2024
Huntington 1	Shut Down Dec 2024
Huntington 2	Shut Down by Dec 2021

Case: C06-2

Coal Unit	Description
Jim Bridger 1	Shut Down by Dec 2023
Jim Bridger 2	Shut Down by Dec 2028
Jim Bridger 3	SCR by Dec 2015
Jim Bridger 4	SCR by Dec 2016
Naughton 1	Shut Down by Dec 2029
Naughton 2	Shut Down by Dec 2029
Naughton 3	Conversion by Jun 2018; Shut Down by Dec 2029
Wyodak	Shut Down by Dec 2032

*SCR = selective catalytic reduction

Federal Tax Incentives

- PTCs expire end of 2013
- ITC of 30% expire end of 2016, thereafter it continues in perpetuity at 10%.

Load Forecast

The figure below shows the medium system coincident peak load forecast applicable to this case before accounting for any potential contribution from DSM or distributed generation resources.

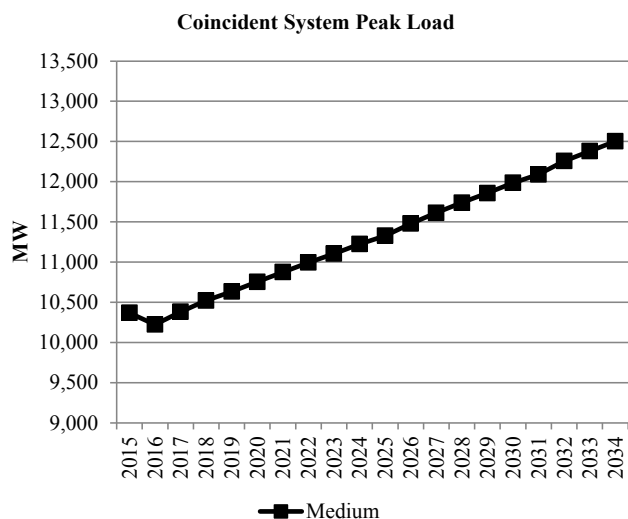

Energy Efficiency (Class 2 DSM)

This case uses base supply curves with economic resource selections up to the achievable potential. Additional energy efficiency beyond economic selections, up to 1.5% of retail sales, is forced into the resource portfolio. Class 2 resources that are not selected or forced in any given year are not available for selection in future years. Achievable potential by state and year are summarized in the following figure.

Class 2 DSM Cumulative Achievable Potential

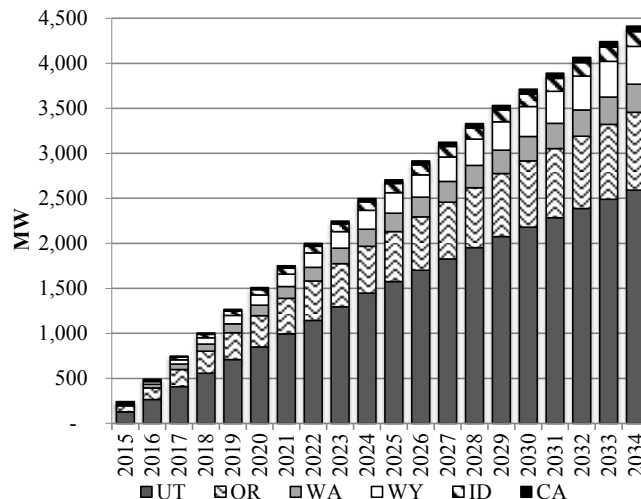

Distributed Generation

Base case distributed generation penetration is assumed in all states. Distributed generation by state and year are summarized below.

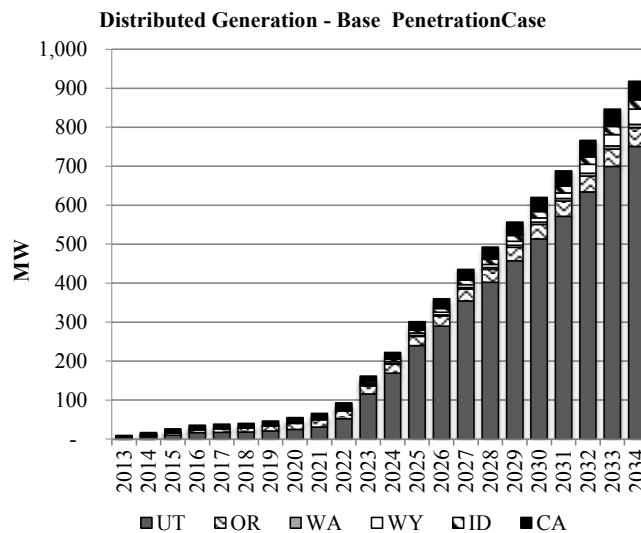

PORTFOLIO SUMMARY

System Optimizer PVRR (\$m)

System Cost without Transmission Upgrades	\$28,530
Transmission Integration	\$10
Transmission Reinforcement	\$10
Total Cost	\$28,549

Resource Portfolio

Cumulative changes to the resource portfolio (new resource additions and resource retirements), represented as nameplate capacity, are summarized in the figure below.

Case: C06-2

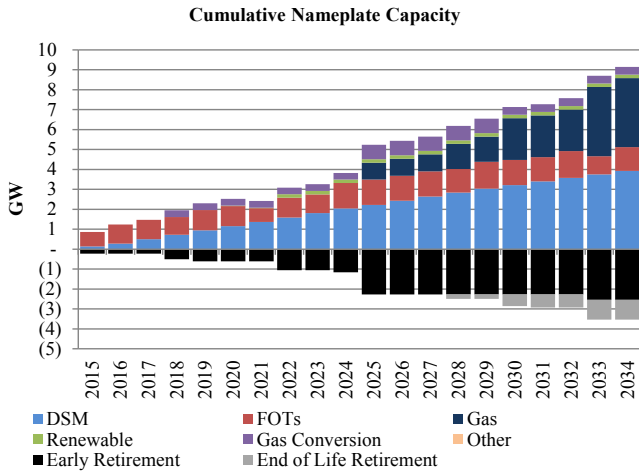

System CO₂ Emissions (System Optimizer)

System CO₂ emissions from System Optimizer are shown alongside those from Cases C01-R and C01-2 in the figure below.

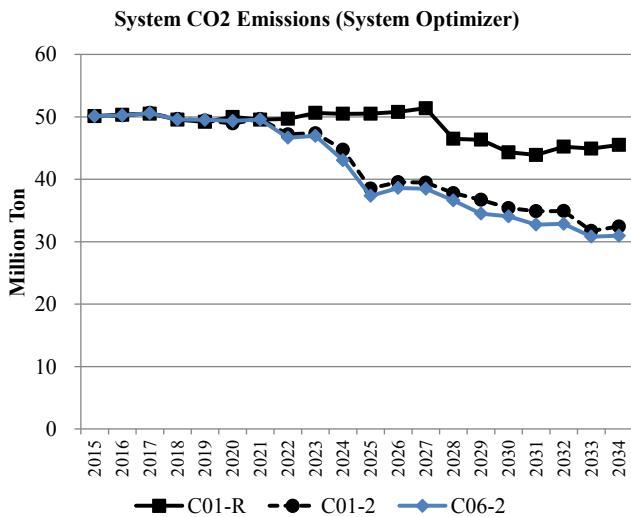

111(d) Compliance Profiles

The following figures summarize how compliance with state emission rate goals is achieved. The sum of each stacked bar represents the fossil emission rate. The net final rate represents the fossil rate after accounting for the emission rate impacts of new thermal (new NGCC units or nuclear, as applicable), re-dispatch of fossil units, energy efficiency (EE), and allocated renewable energy (RE).

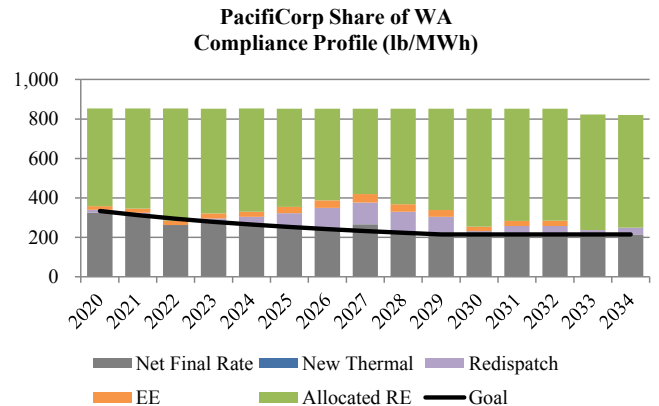
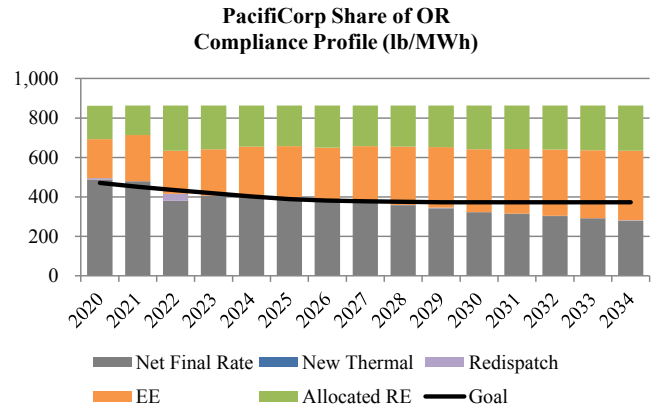
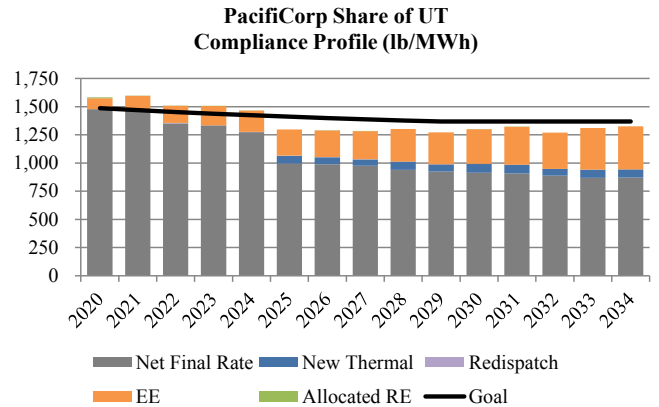
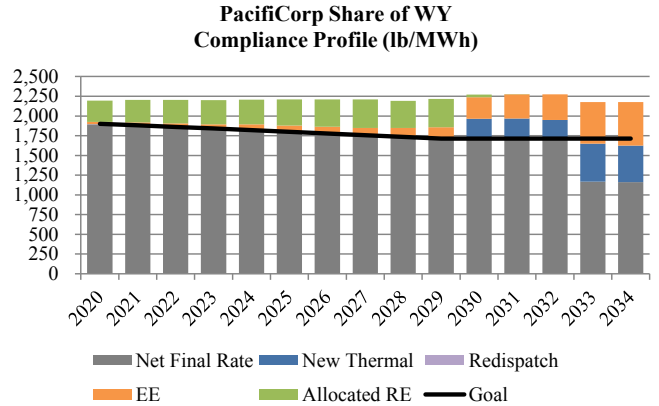

CASE ASSUMPTIONS

Description

Case C07-1 produces a portfolio that meets PacifiCorp’s share of state 111(d) emission rate goals in all states in which PacifiCorp owns fossil generation and has retail customers. The compliance strategy applied to this case relies on flexible allocation of renewable energy and energy efficiency, increased energy efficiency acquisition, and renewable resource acquisition. Re-dispatch of fossil generation is implemented after adding new renewable resources, as required. For planning purposes, this case assumes one of two different Regional Haze compliance scenarios reflecting potential inter-temporal and fleet trade-off compliance outcomes.

Federal CO₂ Policy/Price Signal

C07-1 reflects EPA’s proposed 111(d) rule with no additional CO₂ price signal. The table below summarizes the interim emission rate goal and the final emission rate target by state assumed to apply to PacifiCorp’s system.

State	Interim Goal (Avg. 2020-2029) (lb/MWh)	Final Target (2030 & Beyond) (lb/MWh)
WY	1,808	1,714
UT*	1,378	1,322
OR	407	372
WA	264	215

*EPA’s calculation of the target for UT treated PacifiCorp’s Lakeside 2 NGCC plant as an existing resource. The emission rate assumed for UT assumes Lake Side 2 is correctly classified as “under construction”.

The 111(d) compliance strategy implemented for this case is summarized as follows:

- Flexible allocation of system renewable resources and flexible allocation of cumulative energy efficiency savings beginning 2017 from ID and CA, where PacifiCorp does not own fossil generation.
- Cumulative selection of energy efficiency beginning 2017 up to 1.5% of retail sales.
- New NGCC generation in WY and UT (new NGCC resources are not allowed in OR, WA, and ID).
- Addition of new renewable resources, as required.
- Re-dispatch of existing fossil generation, as required.

Forward Price Curve

Case C07-1 gas and power prices reflect medium natural gas prices and regional compliance with EPA’s proposed 111(d) rule as implemented in the Company’s September 2014 official forward price curve (OFPC).

Nominal Average Annual Henry Hub Gas Prices

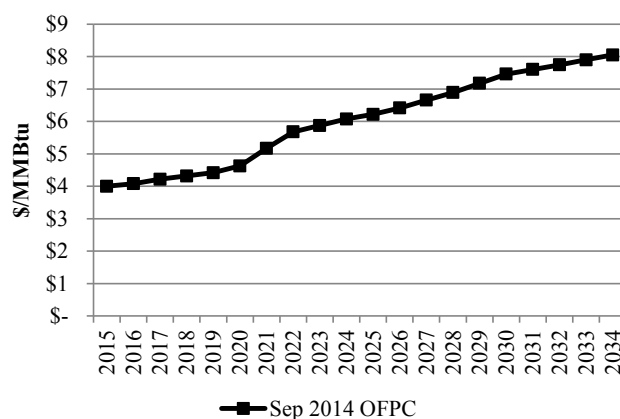

Nominal Average Annual Power Prices (Flat)

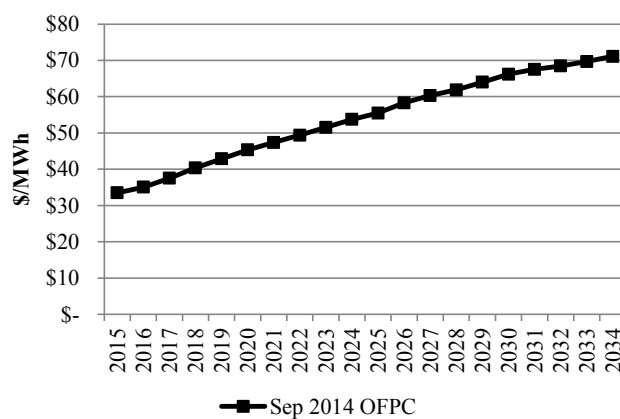

Regional Haze

Case C07-1 reflects Regional Haze Scenario 1, which assumes inter-temporal and fleet trade-off Regional Haze compliance outcomes as shown in the table below. This scenario is for planning purposes recognizing that agency, regulator, and joint owner perspectives on acceptability have not been determined.

Coal Unit	Description
Carbon 1	Shut Down Apr 2015
Carbon 2	Shut Down Apr 2015
Cholla 4	Conversion by Jun 2025
Colstrip 3	SCR by Dec 2023
Colstrip 4	SCR by Dec 2022
Craig 1	SCR by Aug 2021
Craig 2	SCR by Jan 2018
Dave Johnston 1	Shut Down Mar 2019
Dave Johnston 2	Shut Down Dec 2027
Dave Johnston 3	Shut Down Dec 2027
Dave Johnston 4	Shut Down Dec 2032
Hayden 1	SCR by Jun 2015
Hayden 2	SCR by Jun 2016
Hunter 1	SCR by Dec 2021
Hunter 2	Shut Down by Dec 2032
Hunter 3	SCR by Dec 2024
Huntington 1	Shut Down by Dec 2036

Case: C07-1

Coal Unit	Description
Huntington 2	Shut Down by Dec 2021
Jim Bridger 1	Shut Down by Dec 2023
Jim Bridger 2	Shut Down by Dec 2032
Jim Bridger 3	SCR by Dec 2015
Jim Bridger 4	SCR by Dec 2016
Naughton 1	Shut Down by Dec 2029
Naughton 2	Shut Down by Dec 2029
Naughton 3	Conversion by Jun 2018; Shut Down by Dec 2029
Wyodak	Shut Down by Dec 2039

*SCR = selective catalytic reduction

Federal Tax Incentives

- PTCs expire end of 2013
- ITC of 30% expire end of 2016, thereafter it continues in perpetuity at 10%.

Load Forecast

The figure below shows the medium system coincident peak load forecast applicable to this case before accounting for any potential contribution from DSM or distributed generation resources.

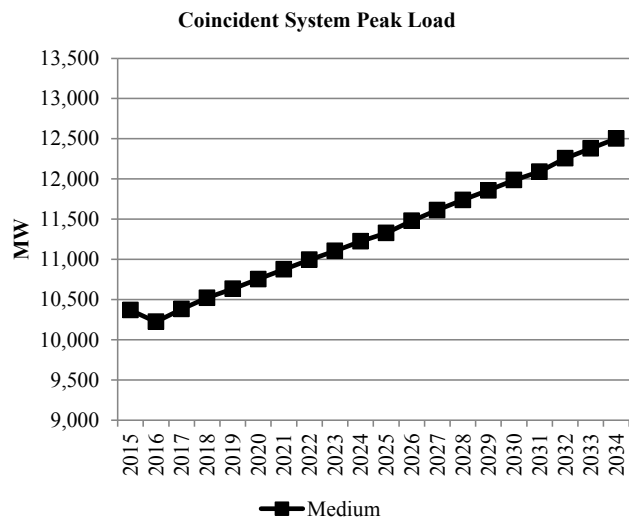

Energy Efficiency (Class 2 DSM)

This case uses base supply curves with economic resource selections up to the achievable potential. Additional energy efficiency beyond economic selections, up to 1.5% of retail sales, is forced into the resource portfolio. Class 2 resources that are not selected or forced in any given year are not available for selection in future years. Achievable potential by state and year are summarized in the following figure.

Class 2 DSM Cumulative Achievable Potential

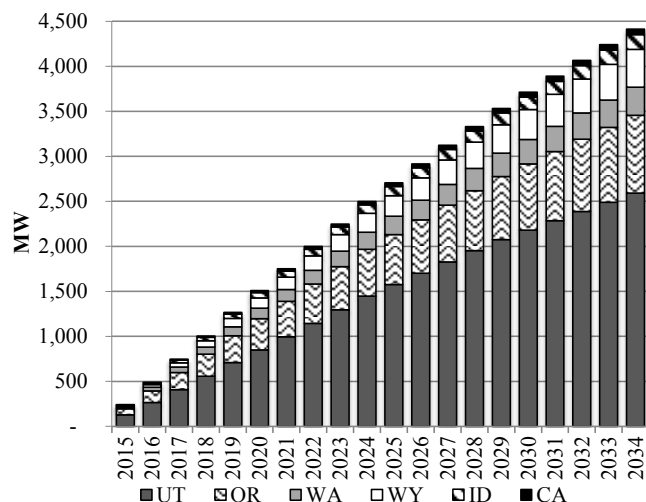

Distributed Generation

Base case distributed generation penetration is assumed in all states. Distributed generation by state and year are summarized below.

Distributed Generation - Base Penetration Case

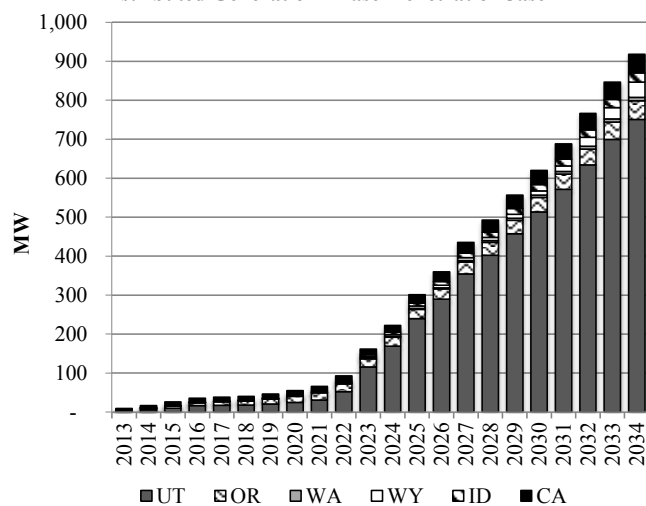

PORTFOLIO SUMMARY

System Optimizer PVRR (\$m)

System Cost without Transmission Upgrades	\$28,449
Transmission Integration	\$60
Transmission Reinforcement	\$6
Total Cost	\$28,516

Resource Portfolio

Cumulative changes to the resource portfolio (new resource additions and resource retirements), represented as nameplate capacity, are summarized in the figure below.

Case: C07-1

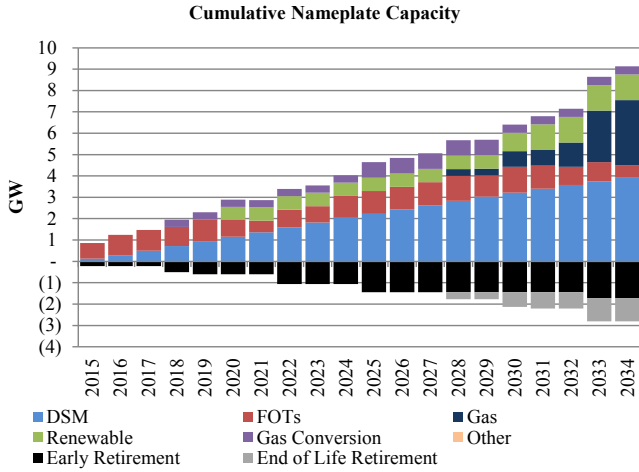

System CO₂ Emissions (System Optimizer)

System CO₂ emissions from System Optimizer are shown alongside those from Cases C01-R and C01-1 in the figure below.

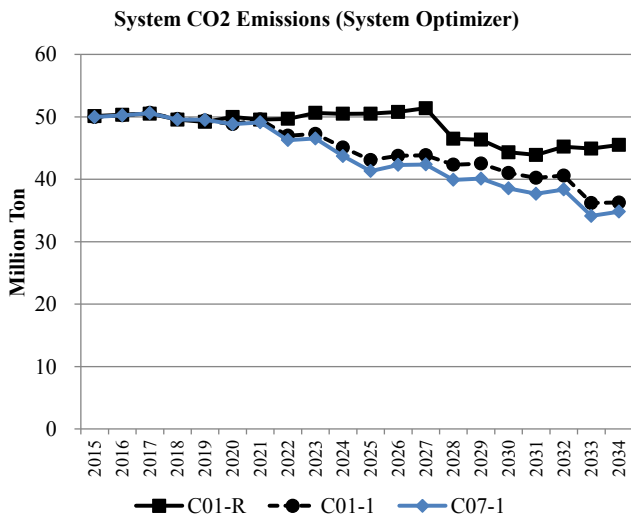

111(d) Compliance Profiles

The following figures summarize how compliance with state emission rate goals is achieved. The sum of each stacked bar represents the fossil emission rate. The net final rate represents the fossil rate after accounting for the emission rate impacts of new thermal (new NGCC units or nuclear, as applicable), re-dispatch of fossil units, energy efficiency (EE), and allocated renewable energy (RE).

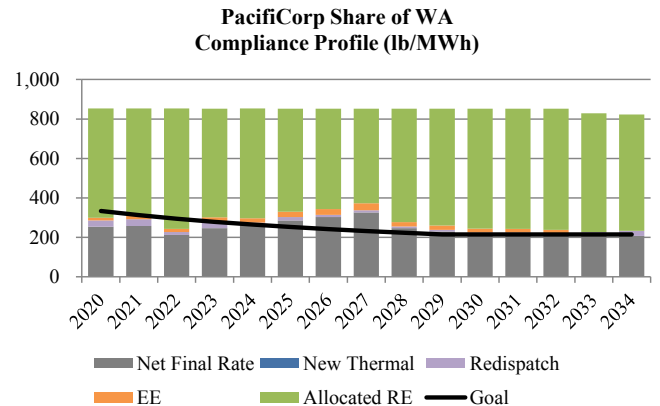
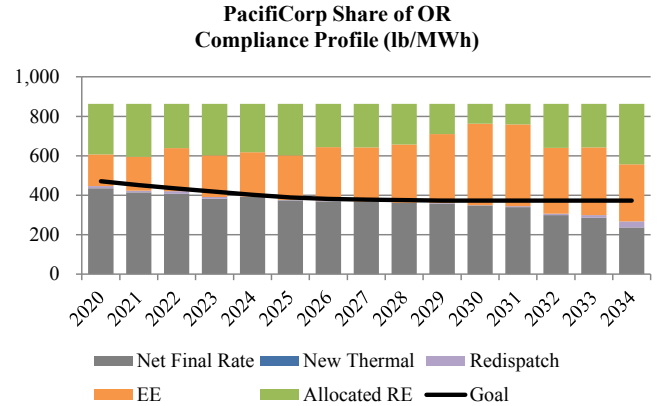
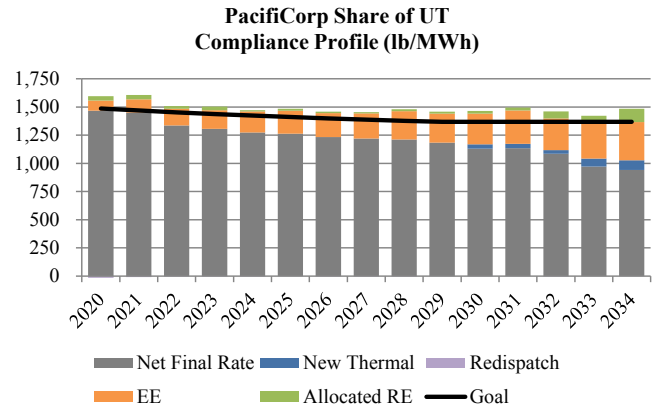
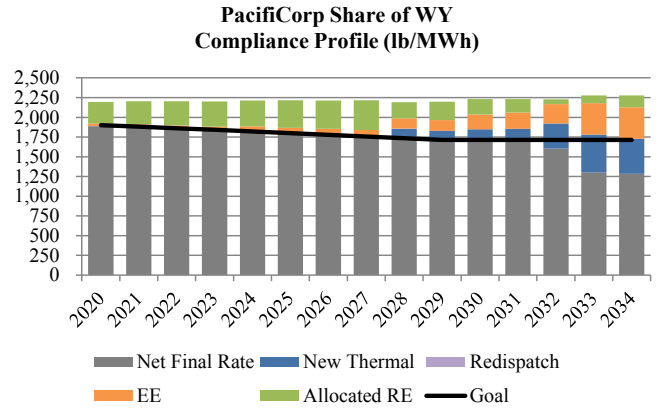

CASE ASSUMPTIONS

Description

Case C07-2 produces a portfolio that meets PacifiCorp’s share of state 111(d) emission rate goals in all states in which PacifiCorp owns fossil generation and has retail customers. The compliance strategy applied to this case relies on flexible allocation of renewable energy and energy efficiency, increased energy efficiency acquisition, and renewable resource acquisition. Re-dispatch of fossil generation is implemented after adding new renewable resources, as required. For planning purposes, this case assumes one of two different Regional Haze compliance scenarios reflecting potential inter-temporal and fleet trade-off compliance outcomes.

Federal CO₂ Policy/Price Signal

C07-2 reflects EPA’s proposed 111(d) rule with no additional CO₂ price signal. The table below summarizes the interim emission rate goal and the final emission rate target by state assumed to apply to PacifiCorp’s system.

State	Interim Goal (Avg. 2020-2029) (lb/MWh)	Final Target (2030 & Beyond) (lb/MWh)
WY	1,808	1,714
UT*	1,378	1,322
OR	407	372
WA	264	215

*EPA’s calculation of the target for UT treated PacifiCorp’s Lakeside 2 NGCC plant as an existing resource. The emission rate assumed for UT assumes Lake Side 2 is correctly classified as “under construction”.

The 111(d) compliance strategy implemented for this case is summarized as follows:

- Flexible allocation of system renewable resources and flexible allocation of cumulative energy efficiency savings beginning 2017 from ID and CA, where PacifiCorp does not own fossil generation.
- Cumulative selection of energy efficiency beginning 2017 up to 1.5% of retail sales.
- New NGCC generation in WY and UT (new NGCC resources are not allowed in OR, WA, and ID).
- Addition of new renewable resources, as required.
- Re-dispatch of existing fossil generation, as required.

Forward Price Curve

Case C07-2 gas and power prices reflect medium natural gas prices and regional compliance with EPA’s proposed 111(d) rule as implemented in the Company’s September 2014 official forward price curve (OFPC).

Nominal Average Annual Henry Hub Gas Prices

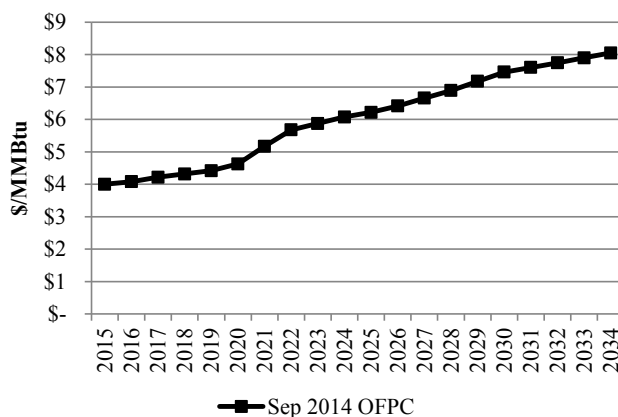

Nominal Average Annual Power Prices (Flat)

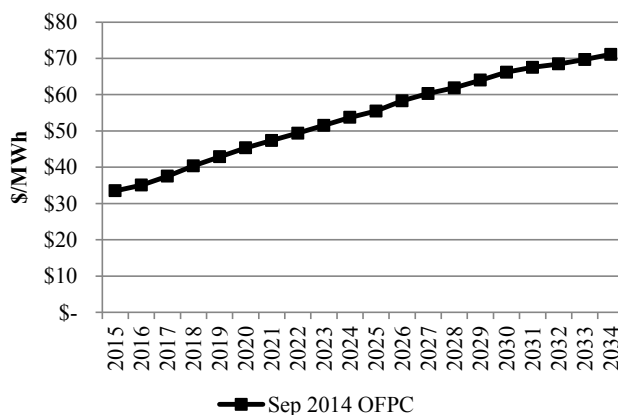

Regional Haze

Case C07-2 reflects Regional Haze Scenario 2, which assumes inter-temporal and fleet trade-off Regional Haze compliance outcomes as shown in the table below. This scenario is for planning purposes recognizing that agency, regulator, and joint owner perspectives on acceptability have not been determined.

Coal Unit	Description
Carbon 1	Shut Down Apr 2015
Carbon 2	Shut Down Apr 2015
Cholla 4	Conversion by Jun 2025
Colstrip 3	SCR by Dec 2023
Colstrip 4	SCR by Dec 2022
Craig 1	SCR by Aug 2021
Craig 2	SCR by Jan 2018
Dave Johnson 1	Shut Down Mar 2019
Dave Johnson 2	Shut Down Dec 2023
Dave Johnson 3	Shut Down Dec 2027
Dave Johnson 4	Shut Down Dec 2032
Hayden 1	SCR by Jun 2015
Hayden 2	SCR by Jun 2016
Hunter 1	SCR by Dec 2021
Hunter 2	Shut Down Dec 2024
Hunter 3	SCR by Dec 2024
Huntington 1	Shut Down Dec 2024
Huntington 2	Shut Down by Dec 2021

Case: C07-2

Coal Unit	Description
Jim Bridger 1	Shut Down by Dec 2023
Jim Bridger 2	Shut Down by Dec 2028
Jim Bridger 3	SCR by Dec 2015
Jim Bridger 4	SCR by Dec 2016
Naughton 1	Shut Down by Dec 2029
Naughton 2	Shut Down by Dec 2029
Naughton 3	Conversion by Jun 2018; Shut Down by Dec 2029
Wyodak	Shut Down by Dec 2032

*SCR = selective catalytic reduction

Federal Tax Incentives

- PTCs expire end of 2013
- ITC of 30% expire end of 2016, thereafter it continues in perpetuity at 10%.

Load Forecast

The figure below shows the medium system coincident peak load forecast applicable to this case before accounting for any potential contribution from DSM or distributed generation resources.

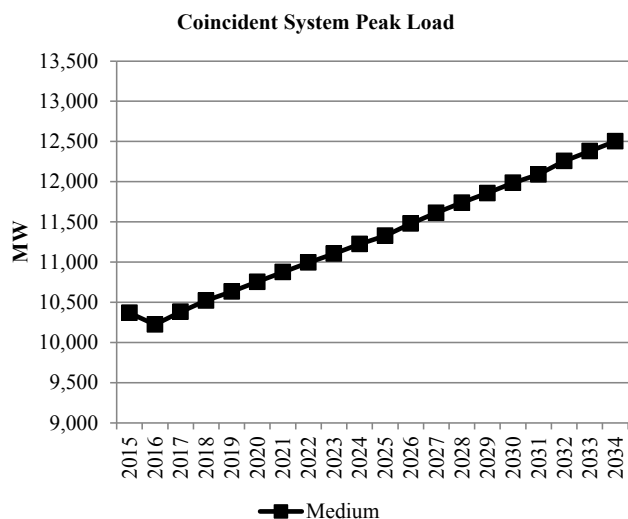

Energy Efficiency (Class 2 DSM)

This case uses base supply curves with economic resource selections up to the achievable potential. Additional energy efficiency beyond economic selections, up to 1.5% of retail sales, is forced into the resource portfolio. Class 2 resources that are not selected or forced in any given year are not available for selection in future years. Achievable potential by state and year are summarized in the following figure.

Class 2 DSM Cumulative Achievable Potential

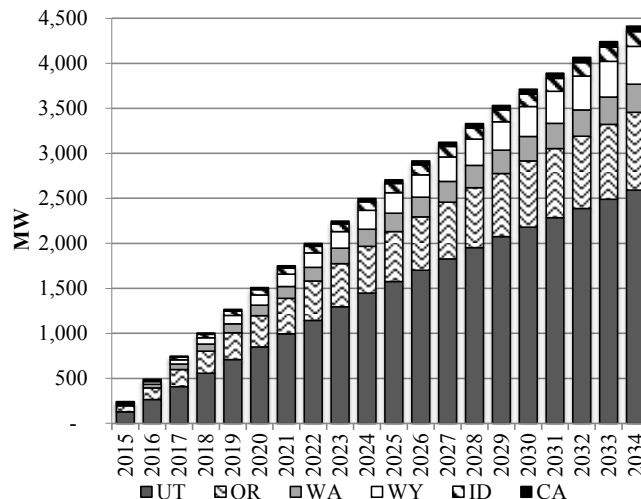

Distributed Generation

Base case distributed generation penetration is assumed in all states. Distributed generation by state and year are summarized below.

Distributed Generation - Base Penetration Case

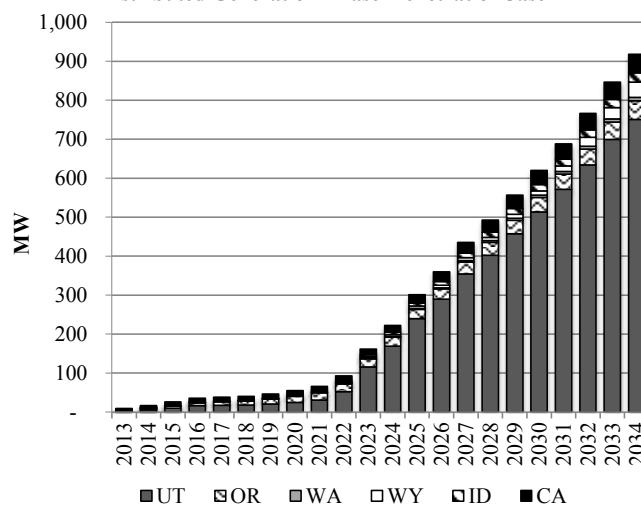

PORTFOLIO SUMMARY

System Optimizer PVRR (\$m)

System Cost without Transmission Upgrades	\$29,028
Transmission Integration	\$78
Transmission Reinforcement	\$10
Total Cost	\$29,115

Resource Portfolio

Cumulative changes to the resource portfolio (new resource additions and resource retirements), represented as nameplate capacity, are summarized in the figure below.

Case: C07-2

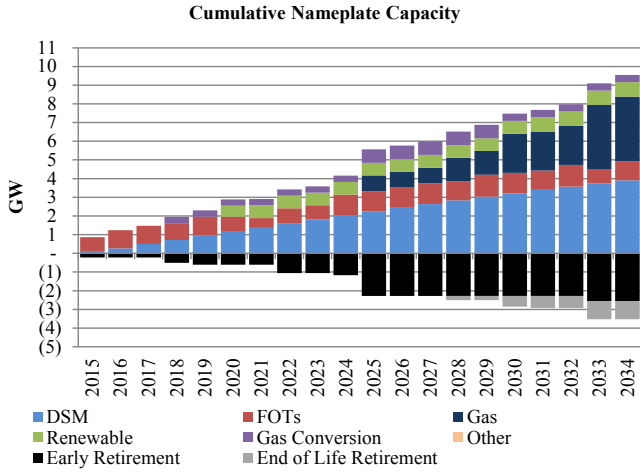

System CO₂ Emissions (System Optimizer)

System CO₂ emissions from System Optimizer are shown alongside those from Cases C01-R and C01-2 in the figure below.

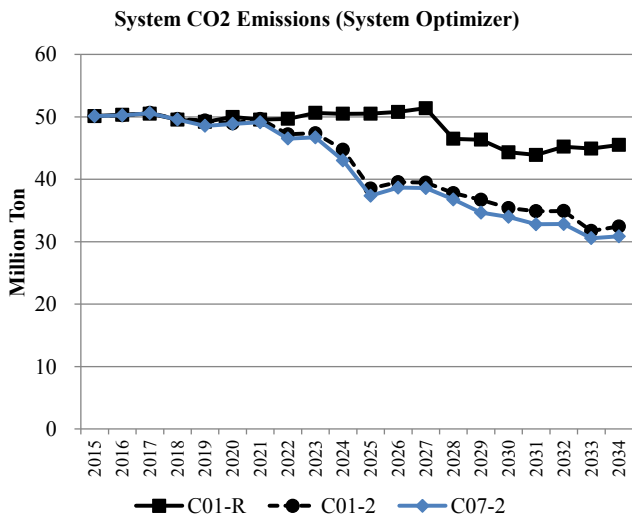

111(d) Compliance Profiles

The following figures summarize how compliance with state emission rate goals is achieved. The sum of each stacked bar represents the fossil emission rate. The net final rate represents the fossil rate after accounting for the emission rate impacts of new thermal (new NGCC units or nuclear, as applicable), re-dispatch of fossil units, energy efficiency (EE), and allocated renewable energy (RE).

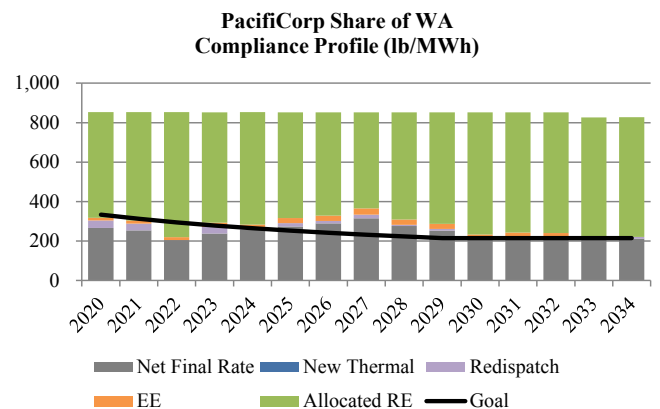
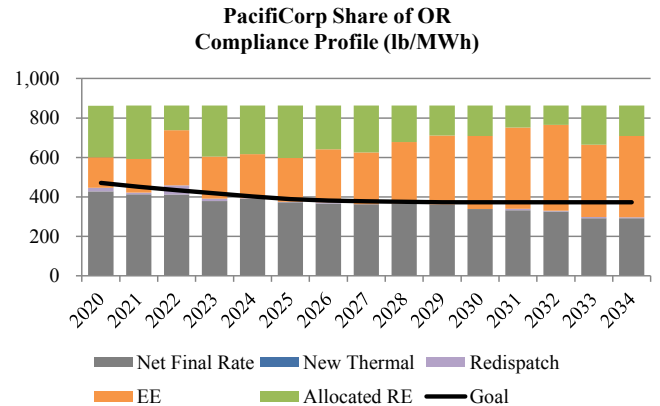
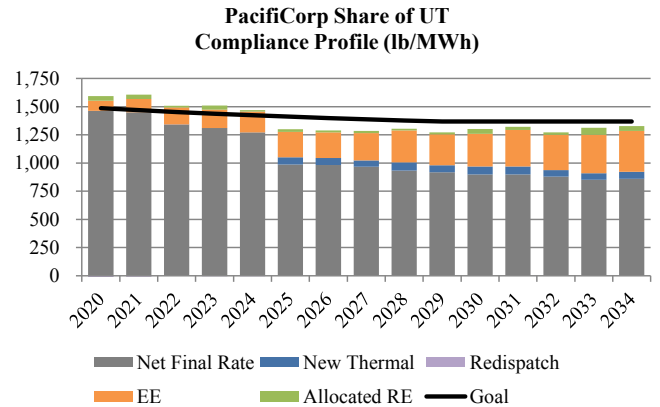
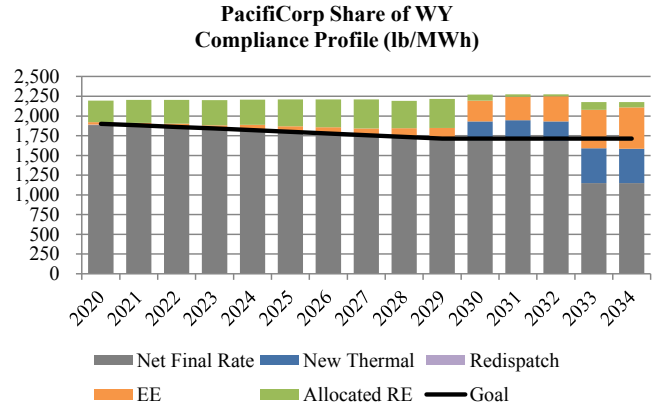

CASE ASSUMPTIONS

Description

Case C09-1 is a variant of Case C05-1 in which the acquisition of front office transactions (FOTs) is eliminated at Mona (300 MW) and NOB (100 MW) beginning 2019. This case produces a portfolio that meets PacifiCorp’s share of state 111(d) emission rate goals in all states in which PacifiCorp has fossil generation and retail customers. The compliance strategy applied to this case relies on flexible allocation of renewable energy and energy efficiency while prioritizing re-dispatch of fossil generation to achieve incremental emission rate reductions as required. For planning purposes, this case assumes one of two different Regional Haze compliance scenarios reflecting potential inter-temporal and fleet trade-off compliance outcomes.

Federal CO₂ Policy/Price Signal

C09-1 reflects EPA’s proposed 111(d) rule with no additional CO₂ price signal. The table below summarizes the interim emission rate goal and the final emission rate target by state assumed to apply to PacifiCorp’s system.

State	Interim Goal (Avg. 2020-2029) (lb/MWh)	Final Target (2030 & Beyond) (lb/MWh)
WY	1,808	1,714
UT*	1,378	1,322
OR	407	372
WA	264	215

*EPA’s calculation of the target for UT treated PacifiCorp’s Lakeside 2 NGCC plant as an existing resource. The emission rate assumed for UT assumes Lake Side 2 is correctly classified as “under construction”.

The 111(d) compliance strategy implemented for this case is summarized as follows:

- Flexible allocation of system renewable resources and flexible allocation of cumulative energy efficiency savings beginning 2017 from ID and CA, where PacifiCorp does not own fossil generation.
- Cumulative cost-effective selection of energy efficiency beginning 2017.
- New NGCC generation in WY and UT (new NGCC resources are not allowed in OR, WA, and ID).
- Re-dispatch of existing fossil generation, as required.
- Addition of new renewable resources, as required.

Forward Price Curve

Case C09-1 gas and power prices reflect medium natural gas prices and regional compliance with EPA’s proposed 111(d) rule as implemented in the Company’s September 2014 official forward price curve (OFPC).

Nominal Average Annual Henry Hub Gas Prices

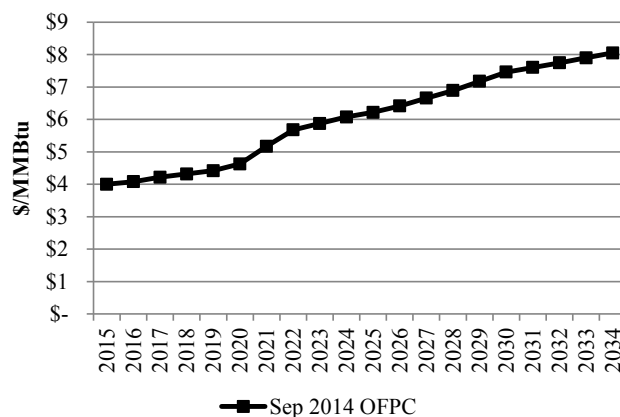

Nominal Average Annual Power Prices (Flat)

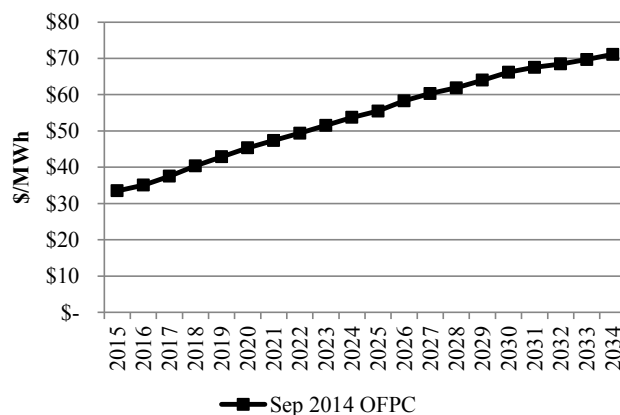

Regional Haze

Case C09-1 reflects Regional Haze Scenario 1, which assumes inter-temporal and fleet trade-off Regional Haze compliance outcomes as shown in the table below. This scenario is for planning purposes recognizing that agency, regulator, and joint owner perspectives on acceptability have not been determined.

Coal Unit	Description
Carbon 1	Shut Down Apr 2015
Carbon 2	Shut Down Apr 2015
Cholla 4	Conversion by Jun 2025
Colstrip 3	SCR by Dec 2023
Colstrip 4	SCR by Dec 2022
Craig 1	SCR by Aug 2021
Craig 2	SCR by Jan 2018
Dave Johnston 1	Shut Down Mar 2019
Dave Johnston 2	Shut Down Dec 2027
Dave Johnston 3	Shut Down Dec 2027
Dave Johnston 4	Shut Down Dec 2032
Hayden 1	SCR by Jun 2015
Hayden 2	SCR by Jun 2016
Hunter 1	SCR by Dec 2021
Hunter 2	Shut Down by Dec 2032
Hunter 3	SCR by Dec 2024
Huntington 1	Shut Down by Dec 2036

Case: C09-1

Coal Unit	Description
Huntington 2	Shut Down by Dec 2021
Jim Bridger 1	Shut Down by Dec 2023
Jim Bridger 2	Shut Down by Dec 2032
Jim Bridger 3	SCR by Dec 2015
Jim Bridger 4	SCR by Dec 2016
Naughton 1	Shut Down by Dec 2029
Naughton 2	Shut Down by Dec 2029
Naughton 3	Conversion by Jun 2018; Shut Down by Dec 2029
Wyodak	Shut Down by Dec 2039

*SCR = selective catalytic reduction

Federal Tax Incentives

- PTCs expire end of 2013
- ITC of 30% expire end of 2016, thereafter it continues in perpetuity at 10%.

Load Forecast

The figure below shows the medium system coincident peak load forecast applicable to this case before accounting for any potential contribution from DSM or distributed generation resources.

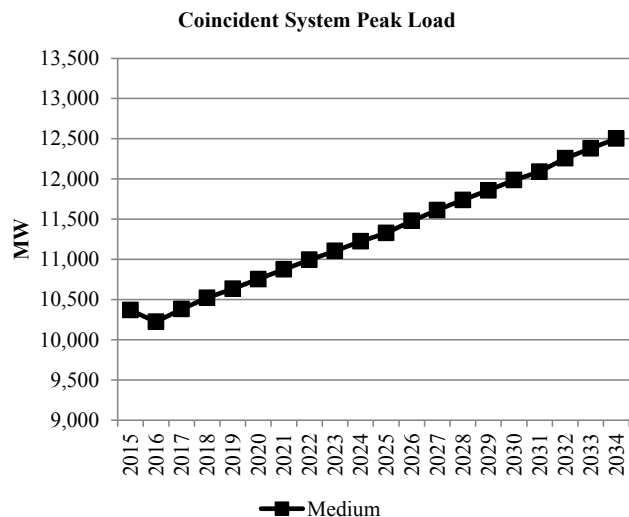

Energy Efficiency (Class 2 DSM)

This case uses base supply curves with economic resource selections up to the achievable potential. Class 2 resources that are not selected in any given year are not available for selection in future years. Achievable potential by state and year are summarized in the following figure.

Class 2 DSM Cumulative Achievable Potential

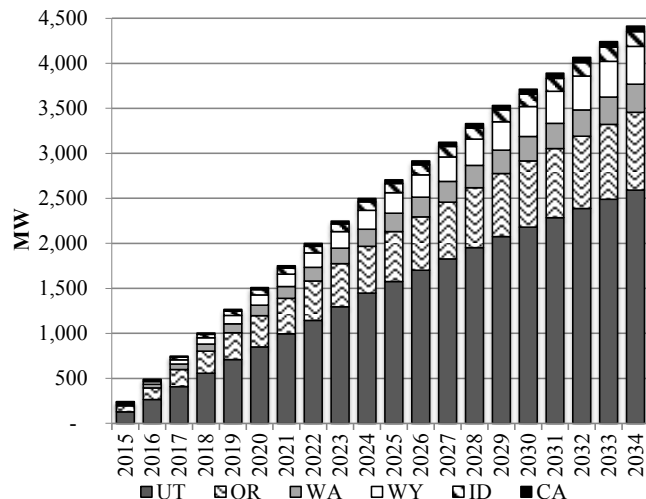

Distributed Generation

Base case distributed generation penetration is assumed in all states. Distributed generation by state and year are summarized below.

Distributed Generation - Base Penetration Case

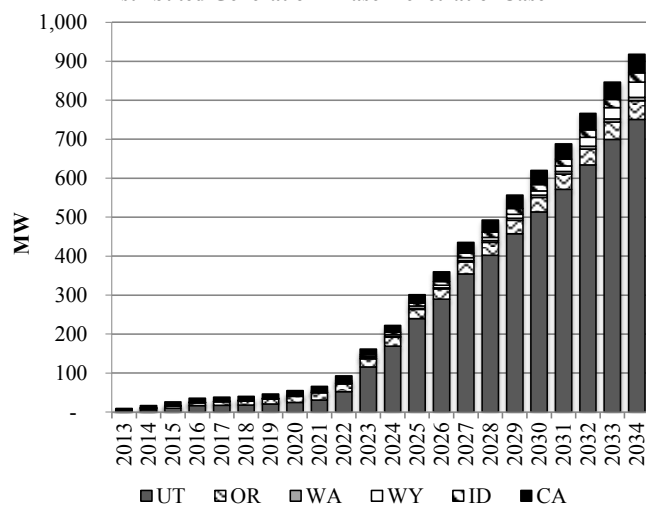

PORTFOLIO SUMMARY

System Optimizer PVRR (\$m)

System Cost without Transmission Upgrades	\$26,764
Transmission Integration	\$39
Transmission Reinforcement	\$6
Total Cost	\$26,809

Resource Portfolio

Cumulative changes to the resource portfolio (new resource additions and resource retirements), represented as nameplate capacity, are summarized in the figure below.

Case: C09-1

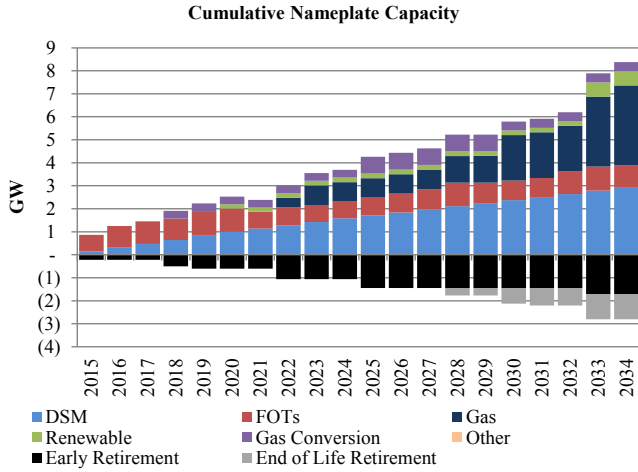

System CO₂ Emissions (System Optimizer)

System CO₂ emissions from System Optimizer are shown alongside those from Cases C01-R and C01-1 in the figure below.

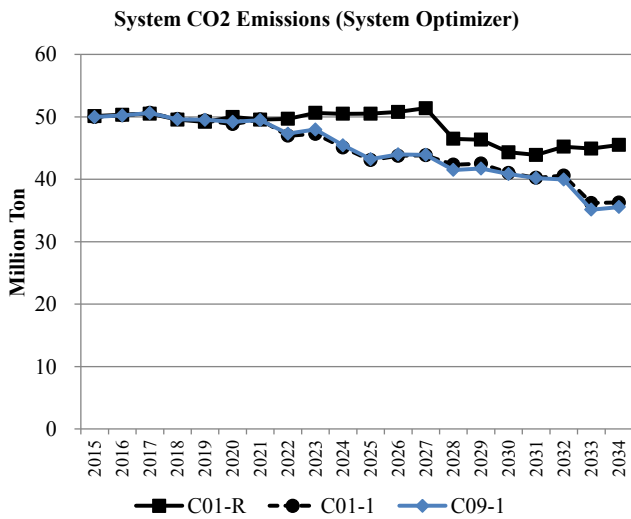

111(d) Compliance Profiles

The following figures summarize how compliance with state emission rate goals is achieved. The sum of each stacked bar represents the fossil emission rate. The net final rate represents the fossil rate after accounting for the emission rate impacts of new thermal (new NGCC units or nuclear, as applicable), re-dispatch of fossil units, energy efficiency (EE), and allocated renewable energy (RE).

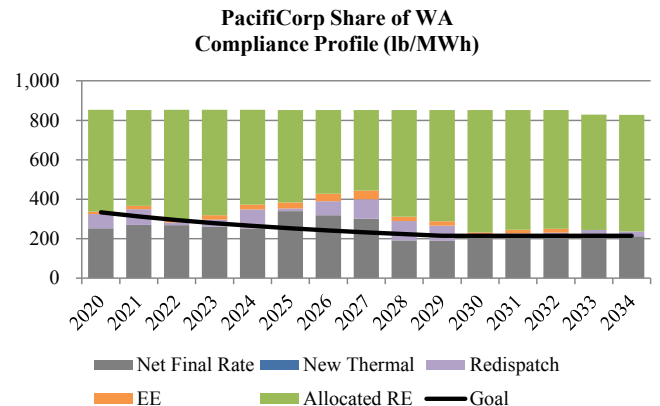
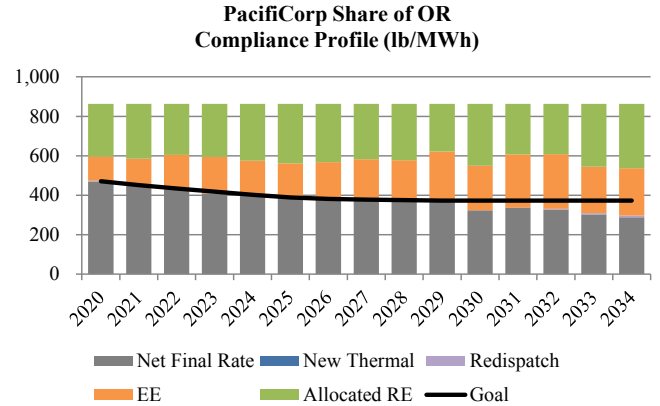
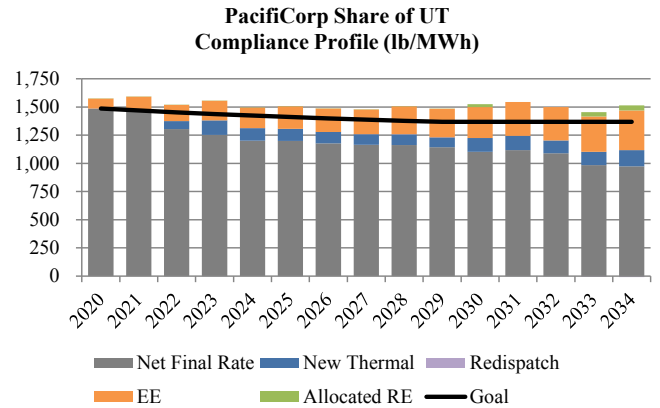
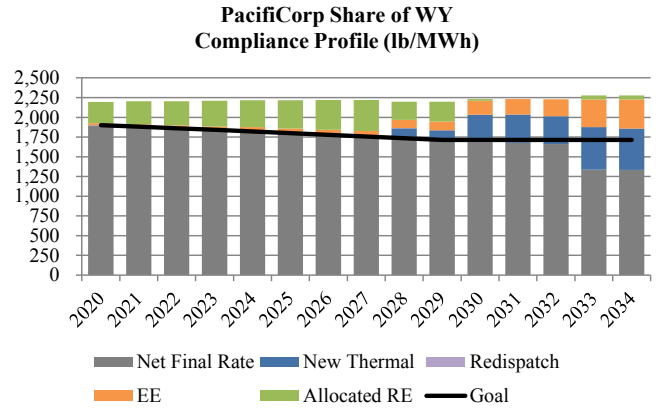

CASE ASSUMPTIONS

Description

Case C09-2 is a variant of Case C05-2 in which the acquisition of front office transactions (FOTs) is eliminated at Mona (300 MW) and NOB (100 MW) beginning 2019. This case produces a portfolio that meets PacifiCorp’s share of state 111(d) emission rate goals in all states in which PacifiCorp has fossil generation and retail customers. The compliance strategy applied to this case relies on flexible allocation of renewable energy and energy efficiency while prioritizing re-dispatch of fossil generation to achieve incremental emission rate reductions as required. For planning purposes, this case assumes one of two different Regional Haze compliance scenarios reflecting potential inter-temporal and fleet trade-off compliance outcomes.

Federal CO₂ Policy/Price Signal

C09-2 reflects EPA’s proposed 111(d) rule with no additional CO₂ price signal. The table below summarizes the interim emission rate goal and the final emission rate target by state assumed to apply to PacifiCorp’s system.

State	Interim Goal (Avg. 2020-2029) (lb/MWh)	Final Target (2030 & Beyond) (lb/MWh)
WY	1,808	1,714
UT*	1,378	1,322
OR	407	372
WA	264	215

*EPA’s calculation of the target for UT treated PacifiCorp’s Lakeside 2 NGCC plant as an existing resource. The emission rate assumed for UT assumes Lake Side 2 is correctly classified as “under construction”.

The 111(d) compliance strategy implemented for this case is summarized as follows:

- Flexible allocation of system renewable resources and flexible allocation of cumulative energy efficiency savings beginning 2017 from ID and CA, where PacifiCorp does not own fossil generation.
- Cumulative cost-effective selection of energy efficiency beginning 2017.
- New NGCC generation in WY and UT (new NGCC resources are not allowed in OR, WA, and ID).
- Re-dispatch of existing fossil generation, as required.
- Addition of new renewable resources, as required.

Forward Price Curve

Case C09-2 gas and power prices reflect medium natural gas prices and regional compliance with EPA’s proposed 111(d) rule as implemented in the Company’s September 2014 official forward price curve (OFPC).

Nominal Average Annual Henry Hub Gas Prices

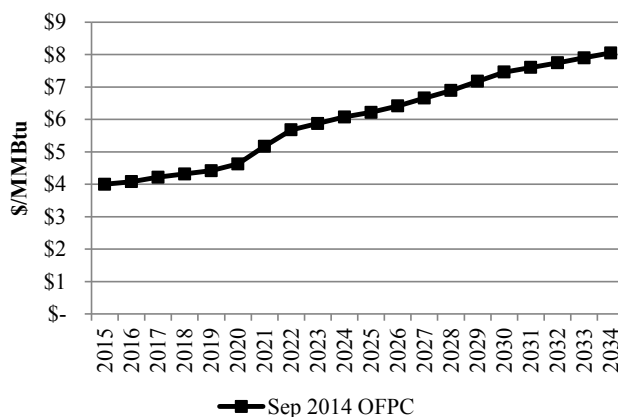

Nominal Average Annual Power Prices (Flat)

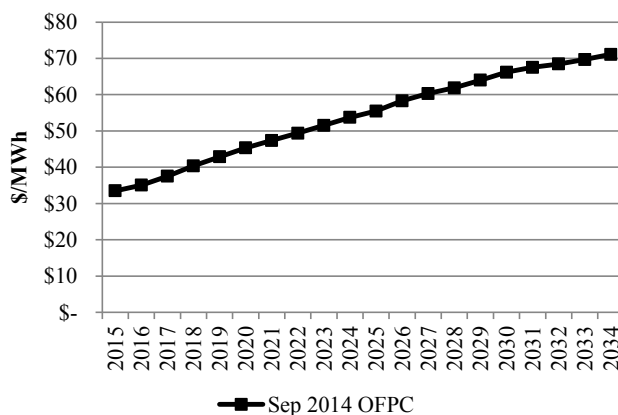

Regional Haze

Case C09-2 reflects Regional Haze Scenario 2, which assumes inter-temporal and fleet trade-off Regional Haze compliance outcomes as shown in the table below. This scenario is for planning purposes recognizing that agency, regulator, and joint owner perspectives on acceptability have not been determined.

Coal Unit	Description
Carbon 1	Shut Down Apr 2015
Carbon 2	Shut Down Apr 2015
Cholla 4	Conversion by Jun 2025
Colstrip 3	SCR by Dec 2023
Colstrip 4	SCR by Dec 2022
Craig 1	SCR by Aug 2021
Craig 2	SCR by Jan 2018
Dave Johnson 1	Shut Down Mar 2019
Dave Johnson 2	Shut Down Dec 2023
Dave Johnson 3	Shut Down Dec 2027
Dave Johnson 4	Shut Down Dec 2032
Hayden 1	SCR by Jun 2015
Hayden 2	SCR by Jun 2016
Hunter 1	SCR by Dec 2021
Hunter 2	Shut Down Dec 2024
Hunter 3	SCR by Dec 2024
Huntington 1	Shut Down Dec 2024

Case: C09-2

Coal Unit	Description
Huntington 2	Shut Down by Dec 2021
Jim Bridger 1	Shut Down by Dec 2023
Jim Bridger 2	Shut Down by Dec 2028
Jim Bridger 3	SCR by Dec 2015
Jim Bridger 4	SCR by Dec 2016
Naughton 1	Shut Down by Dec 2029
Naughton 2	Shut Down by Dec 2029
Naughton 3	Conversion by Jun 2018; Shut Down by Dec 2029
Wyodak	Shut Down by Dec 2032

*SCR = selective catalytic reduction

Federal Tax Incentives

- PTCs expire end of 2013
- ITC of 30% expire end of 2016, thereafter it continues in perpetuity at 10%.

Load Forecast

The figure below shows the medium system coincident peak load forecast applicable to this case before accounting for any potential contribution from DSM or distributed generation resources.

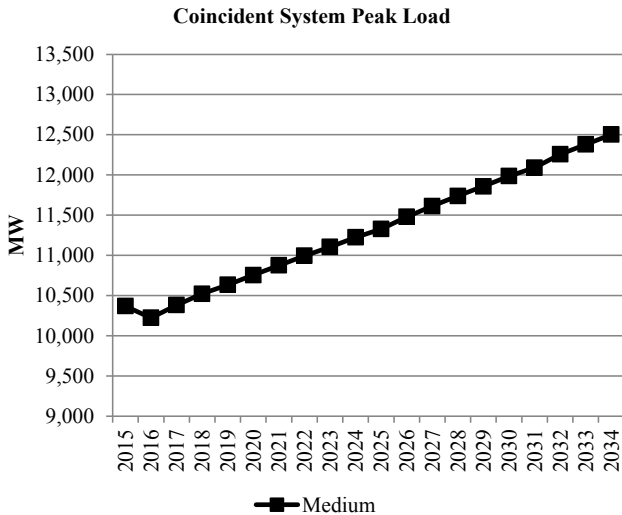

Energy Efficiency (Class 2 DSM)

This case uses base supply curves with economic resource selections up to the achievable potential. Class 2 resources that are not selected in any given year are not available for selection in future years. Achievable potential by state and year are summarized in the following figure.

Class 2 DSM Cumulative Achievable Potential

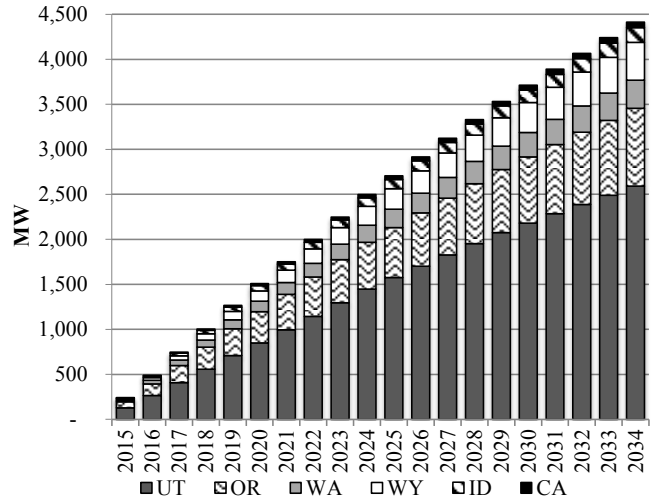

Distributed Generation

Base case distributed generation penetration is assumed in all states. Distributed generation by state and year are summarized below.

Distributed Generation - Base Penetration Case

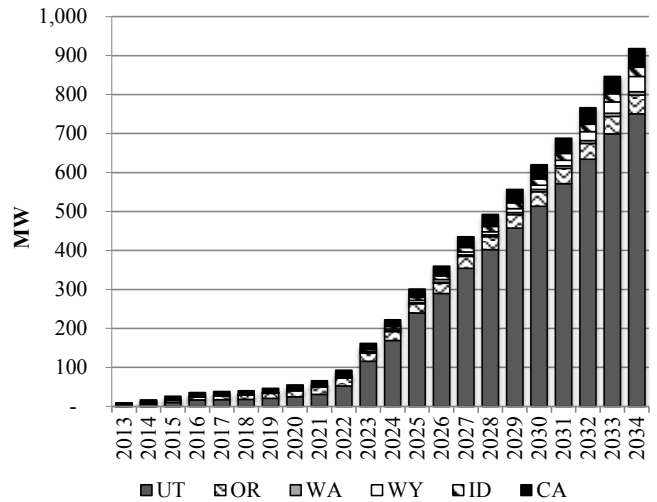

PORTFOLIO SUMMARY

System Optimizer PVRR (\$m)

System Cost without Transmission Upgrades	\$27,361
Transmission Integration	\$83
Transmission Reinforcement	\$10
Total Cost	\$27,454

Resource Portfolio

Cumulative changes to the resource portfolio (new resource additions and resource retirements), represented as nameplate capacity, are summarized in the figure below.

Case: C09-2

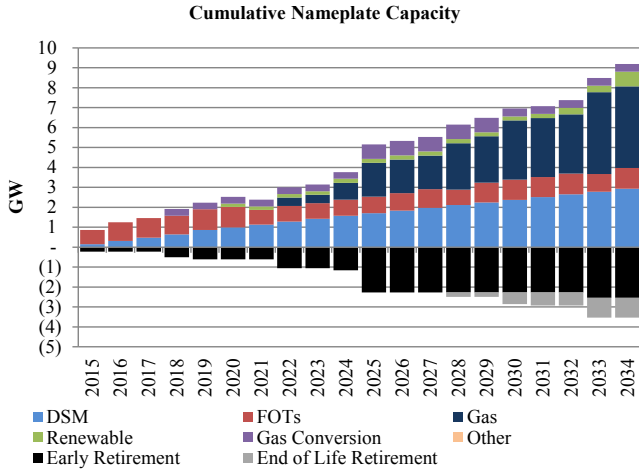

System CO₂ Emissions (System Optimizer)

System CO₂ emissions from System Optimizer are shown alongside those from Cases C01-R and C01-2 in the figure below.

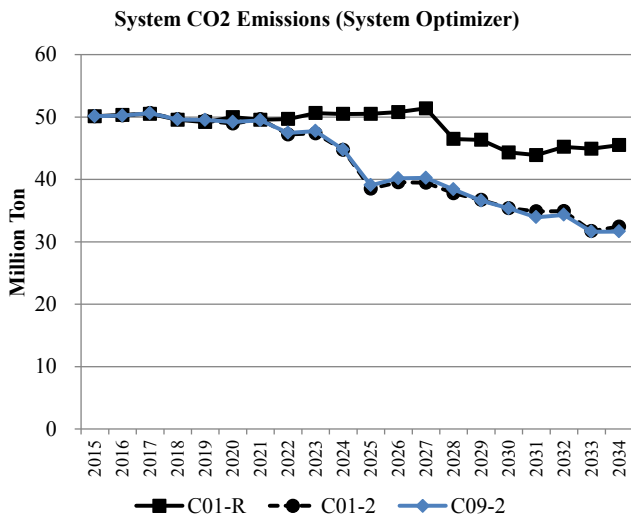

111(d) Compliance Profiles

The following figures summarize how compliance with state emission rate goals is achieved. The sum of each stacked bar represents the fossil emission rate. The net final rate represents the fossil rate after accounting for the emission rate impacts of new thermal (new NGCC units or nuclear, as applicable), re-dispatch of fossil units, energy efficiency (EE), and allocated renewable energy (RE).

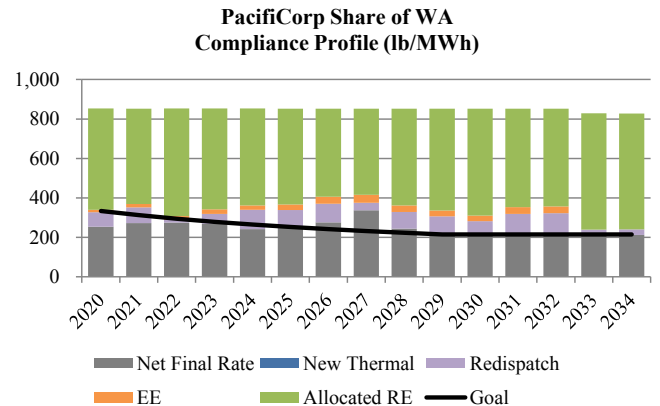
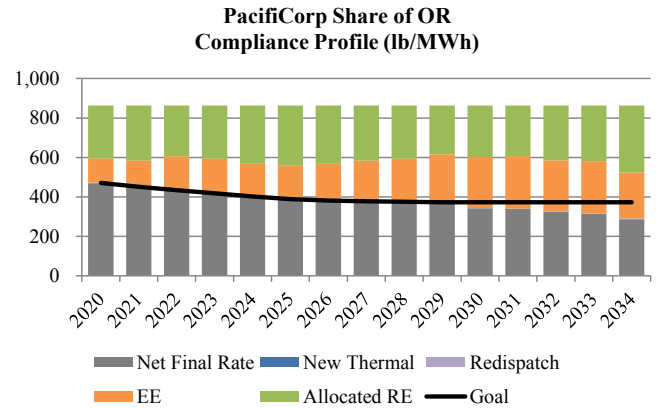
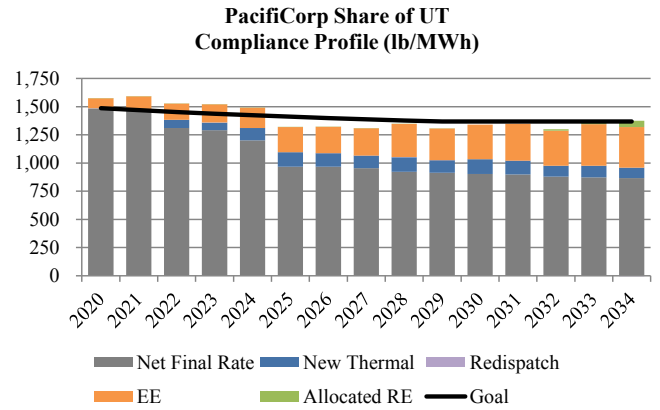
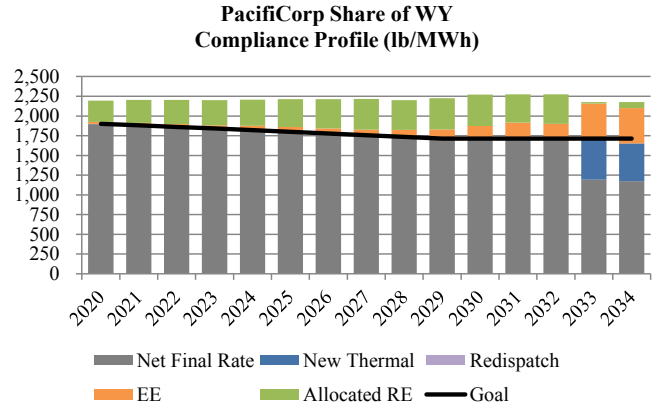

CASE ASSUMPTIONS

Description

Case C11-1 is a variant of Case C05-1 in which accelerated Class 2 DSM supply curves are used in developing the resource portfolio. This case produces a portfolio that meets PacifiCorp’s share of state 111(d) emission rate goals in all states in which PacifiCorp has fossil generation and retail customers. The compliance strategy applied to this case relies on flexible allocation of renewable energy and energy efficiency while prioritizing re-dispatch of fossil generation to achieve incremental emission rate reductions as required. For planning purposes, this case assumes one of two different Regional Haze compliance scenarios reflecting potential inter-temporal and fleet trade-off compliance outcomes.

Federal CO₂ Policy/Price Signal

C11-1 reflects EPA’s proposed 111(d) rule with no additional CO₂ price signal. The table below summarizes the interim emission rate goal and the final emission rate target by state assumed to apply to PacifiCorp’s system.

State	Interim Goal (Avg. 2020-2029) (lb/MWh)	Final Target (2030 & Beyond) (lb/MWh)
WY	1,808	1,714
UT*	1,378	1,322
OR	407	372
WA	264	215

*EPA’s calculation of the target for UT treated PacifiCorp’s Lakeside 2 NGCC plant as an existing resource. The emission rate assumed for UT assumes Lake Side 2 is correctly classified as “under construction”.

The 111(d) compliance strategy implemented for this case is summarized as follows:

- Flexible allocation of system renewable resources and flexible allocation of cumulative energy efficiency savings beginning 2017 from ID and CA, where PacifiCorp does not own fossil generation.
- Cumulative cost-effective selection of energy efficiency beginning 2017.
- New NGCC generation in WY and UT (new NGCC resources are not allowed in OR, WA, and ID).
- Re-dispatch of existing fossil generation, as required.
- Addition of new renewable resources, as required.

Forward Price Curve

Case C11-1 gas and power prices reflect medium natural gas prices and regional compliance with EPA’s proposed 111(d) rule as implemented in the Company’s September 2014 official forward price curve (OFPC).

Nominal Average Annual Henry Hub Gas Prices

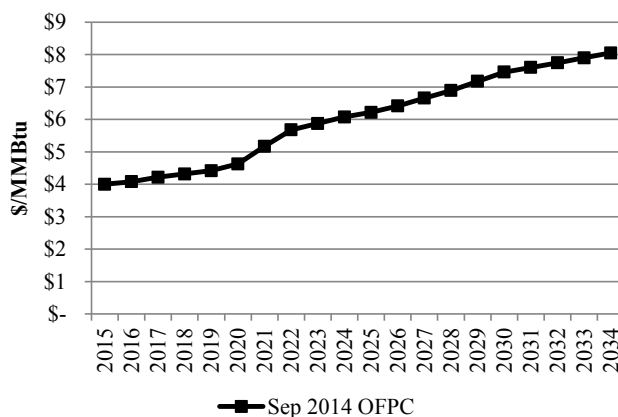

Nominal Average Annual Power Prices (Flat)

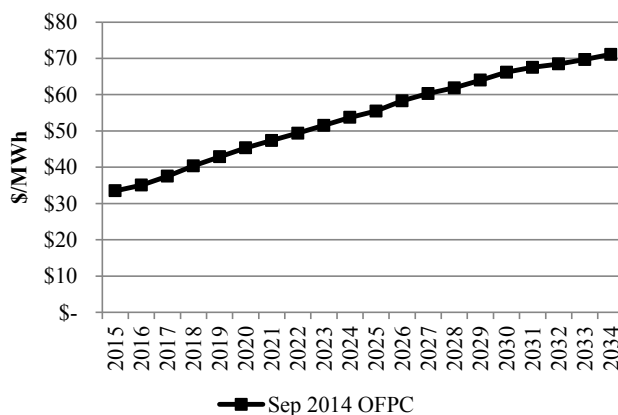

Regional Haze

Case C11-1 reflects Regional Haze Scenario 1, which assumes inter-temporal and fleet trade-off Regional Haze compliance outcomes as shown in the table below. This scenario is for planning purposes recognizing that agency, regulator, and joint owner perspectives on acceptability have not been determined.

Coal Unit	Description
Carbon 1	Shut Down Apr 2015
Carbon 2	Shut Down Apr 2015
Cholla 4	Conversion by Jun 2025
Colstrip 3	SCR by Dec 2023
Colstrip 4	SCR by Dec 2022
Craig 1	SCR by Aug 2021
Craig 2	SCR by Jan 2018
Dave Johnston 1	Shut Down Mar 2019
Dave Johnston 2	Shut Down Dec 2027
Dave Johnston 3	Shut Down Dec 2027
Dave Johnston 4	Shut Down Dec 2032
Hayden 1	SCR by Jun 2015
Hayden 2	SCR by Jun 2016
Hunter 1	SCR by Dec 2021
Hunter 2	Shut Down by Dec 2032
Hunter 3	SCR by Dec 2024
Huntington 1	Shut Down by Dec 2036

Case: C11-1

Coal Unit	Description
Huntington 2	Shut Down by Dec 2021
Jim Bridger 1	Shut Down by Dec 2023
Jim Bridger 2	Shut Down by Dec 2032
Jim Bridger 3	SCR by Dec 2015
Jim Bridger 4	SCR by Dec 2016
Naughton 1	Shut Down by Dec 2029
Naughton 2	Shut Down by Dec 2029
Naughton 3	Conversion by Jun 2018; Shut Down by Dec 2029
Wyodak	Shut Down by Dec 2039

*SCR = selective catalytic reduction

Federal Tax Incentives

- PTCs expire end of 2013
- ITC of 30% expire end of 2016, thereafter it continues in perpetuity at 10%.

Load Forecast

The figure below shows the medium system coincident peak load forecast applicable to this case before accounting for any potential contribution from DSM or distributed generation resources.

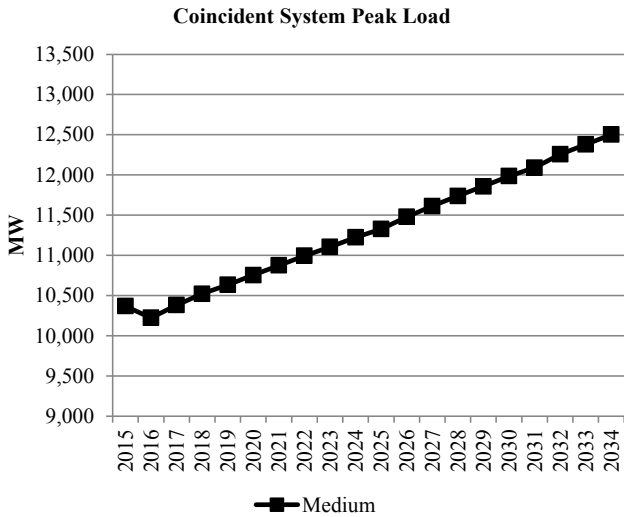

Energy Efficiency (Class 2 DSM)

Accelerated case supply curves and ramp rates with resource selections up to the achievable potential. Class 2 resources that are not selected in any given year are not available for selection in future years. Accelerated achievable potential by state and year are summarized below.

Acc. Class 2 DSM Cumulative Achievable Potential

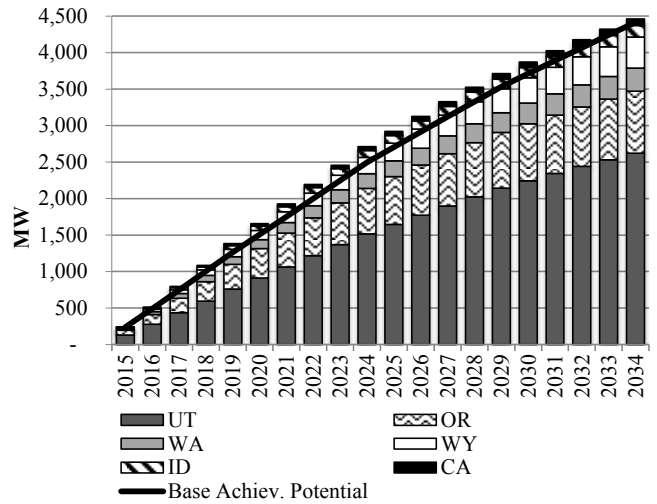

Distributed Generation

Base case distributed generation penetration is assumed in all states. Distributed generation by state and year are summarized below.

Distributed Generation - Base PenetrationCase

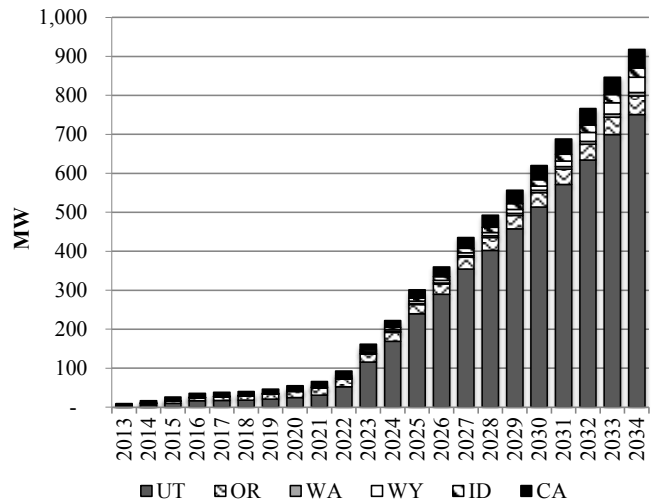

PORTFOLIO SUMMARY

System Optimizer PVRR (\$m)

System Cost without Transmission Upgrades	\$26,606
Transmission Integration	\$35
Transmission Reinforcement	\$6
Total Cost	\$26,649

Resource Portfolio

Cumulative changes to the resource portfolio (new resource additions and resource retirements), represented as nameplate capacity, are summarized in the figure below.

Case: C11-1

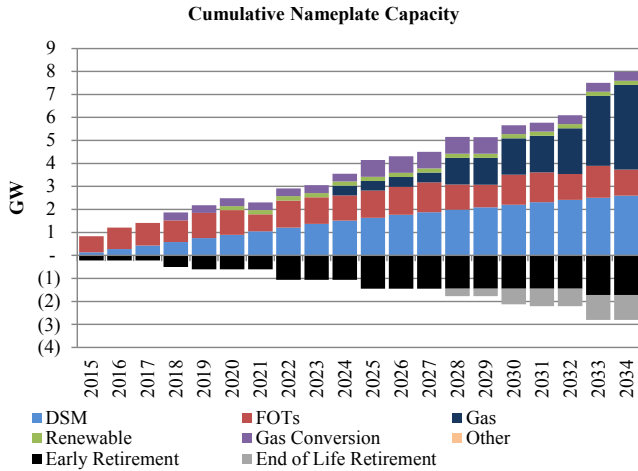

System CO₂ Emissions (System Optimizer)

System CO₂ emissions from System Optimizer are shown alongside those from Cases C01-R and C01-1 in the figure below.

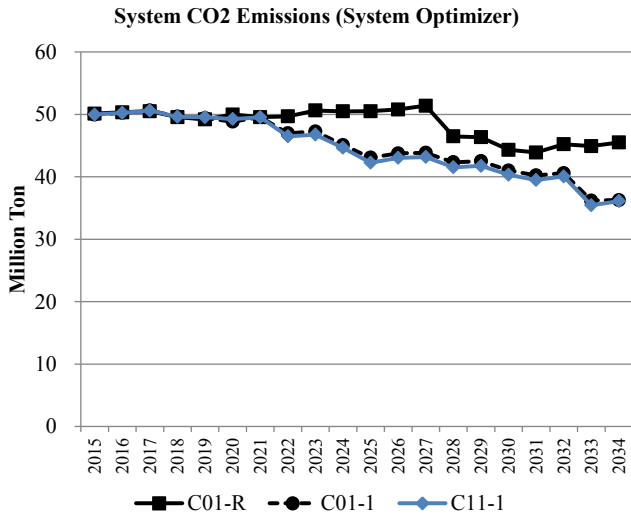

111(d) Compliance Profiles

The following figures summarize how compliance with state emission rate goals is achieved. The sum of each stacked bar represents the fossil emission rate. The net final rate represents the fossil rate after accounting for the emission rate impacts of new thermal (new NGCC units or nuclear, as applicable), re-dispatch of fossil units, energy efficiency (EE), and allocated renewable energy (RE).

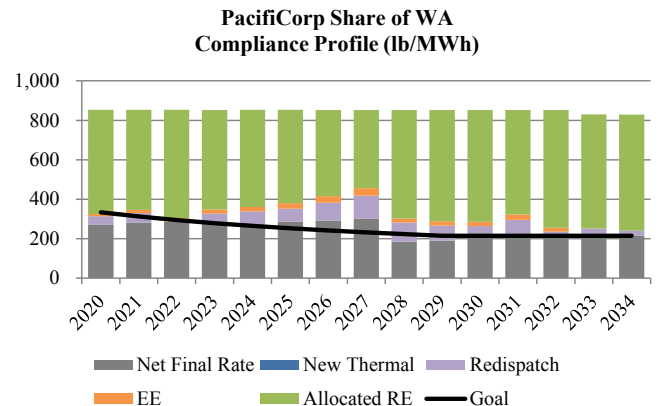
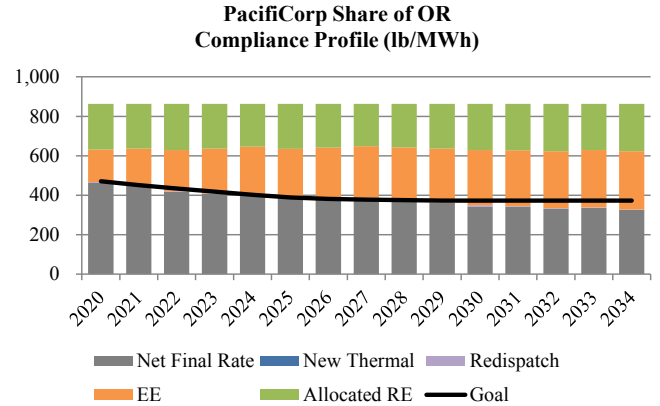
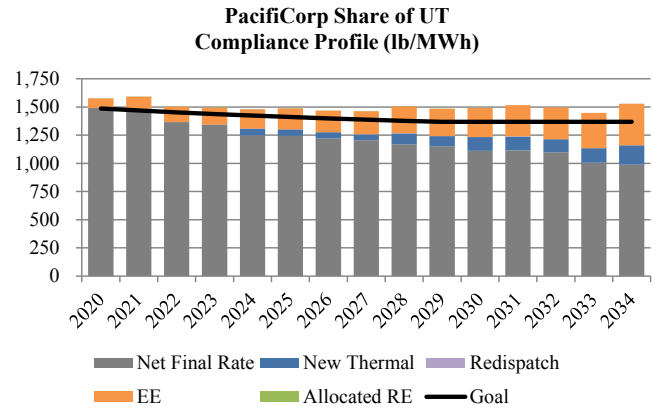
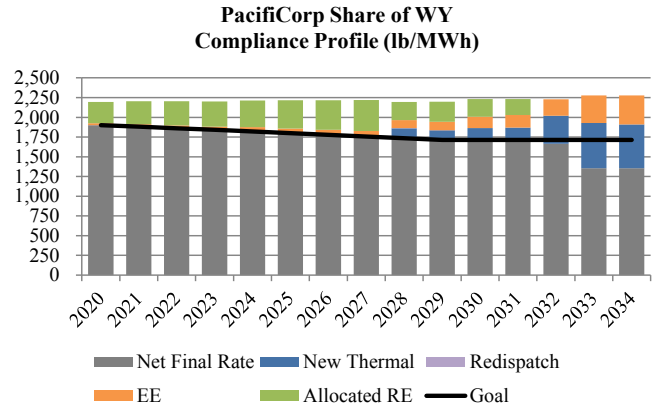

CASE ASSUMPTIONS

Description

Case C11-2 is a variant of Case C05-2 in which accelerated Class 2 DSM supply curves are used in developing the resource portfolio. This case produces a portfolio that meets PacifiCorp’s share of state 111(d) emission rate goals in all states in which PacifiCorp has fossil generation and retail customers. The compliance strategy applied to this case relies on flexible allocation of renewable energy and energy efficiency while prioritizing re-dispatch of fossil generation to achieve incremental emission rate reductions as required. For planning purposes, this case assumes one of two different Regional Haze compliance scenarios reflecting potential inter-temporal and fleet trade-off compliance outcomes.

Federal CO₂ Policy/Price Signal

C11-2 reflects EPA’s proposed 111(d) rule with no additional CO₂ price signal. The table below summarizes the interim emission rate goal and the final emission rate target by state assumed to apply to PacifiCorp’s system.

State	Interim Goal (Avg. 2020-2029) (lb/MWh)	Final Target (2030 & Beyond) (lb/MWh)
WY	1,808	1,714
UT*	1,378	1,322
OR	407	372
WA	264	215

*EPA’s calculation of the target for UT treated PacifiCorp’s Lakeside 2 NGCC plant as an existing resource. The emission rate assumed for UT assumes Lake Side 2 is correctly classified as “under construction”.

The 111(d) compliance strategy implemented for this case is summarized as follows:

- Flexible allocation of system renewable resources and flexible allocation of cumulative energy efficiency savings beginning 2017 from ID and CA, where PacifiCorp does not own fossil generation.
- Cumulative cost-effective selection of energy efficiency beginning 2017.
- New NGCC generation in WY and UT (new NGCC resources are not allowed in OR, WA, and ID).
- Re-dispatch of existing fossil generation, as required.
- Addition of new renewable resources, as required.

Forward Price Curve

Case C11-2 gas and power prices reflect medium natural gas prices and regional compliance with EPA’s proposed 111(d) rule as implemented in the Company’s September 2014 official forward price curve (OFPC).

Nominal Average Annual Henry Hub Gas Prices

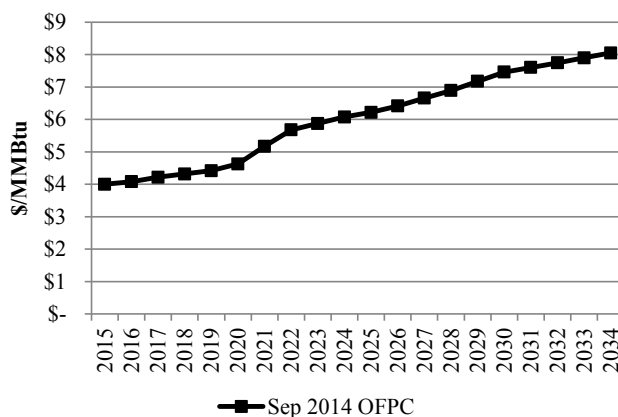

Nominal Average Annual Power Prices (Flat)

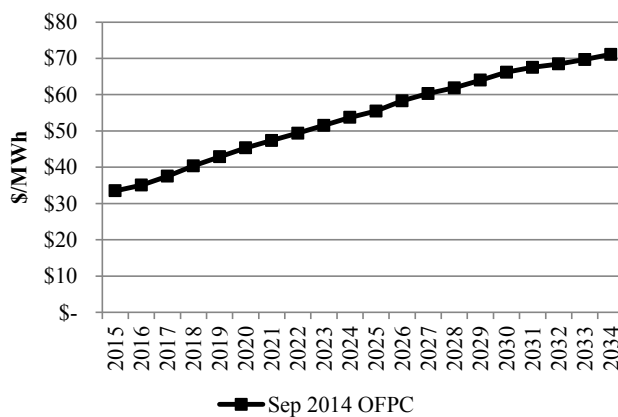

Regional Haze

Case C11-2 reflects Regional Haze Scenario 2, which assumes inter-temporal and fleet trade-off Regional Haze compliance outcomes as shown in the table below. This scenario is for planning purposes recognizing that agency, regulator, and joint owner perspectives on acceptability have not been determined.

Coal Unit	Description
Carbon 1	Shut Down Apr 2015
Carbon 2	Shut Down Apr 2015
Cholla 4	Conversion by Jun 2025
Colstrip 3	SCR by Dec 2023
Colstrip 4	SCR by Dec 2022
Craig 1	SCR by Aug 2021
Craig 2	SCR by Jan 2018
Dave Johnson 1	Shut Down Mar 2019
Dave Johnson 2	Shut Down Dec 2023
Dave Johnson 3	Shut Down Dec 2027
Dave Johnson 4	Shut Down Dec 2032
Hayden 1	SCR by Jun 2015
Hayden 2	SCR by Jun 2016
Hunter 1	SCR by Dec 2021
Hunter 2	Shut Down Dec 2024
Hunter 3	SCR by Dec 2024
Huntington 1	Shut Down Dec 2024

Case: C11-2

Coal Unit	Description
Huntington 2	Shut Down by Dec 2021
Jim Bridger 1	Shut Down by Dec 2023
Jim Bridger 2	Shut Down by Dec 2028
Jim Bridger 3	SCR by Dec 2015
Jim Bridger 4	SCR by Dec 2016
Naughton 1	Shut Down by Dec 2029
Naughton 2	Shut Down by Dec 2029
Naughton 3	Conversion by Jun 2018; Shut Down by Dec 2029
Wyodak	Shut Down by Dec 2032

* SCR = selective catalytic reduction

Federal Tax Incentives

- PTCs expire end of 2013
- ITC of 30% expire end of 2016, thereafter it continues in perpetuity at 10%.

Load Forecast

The figure below shows the medium system coincident peak load forecast applicable to this case before accounting for any potential contribution from DSM or distributed generation resources.

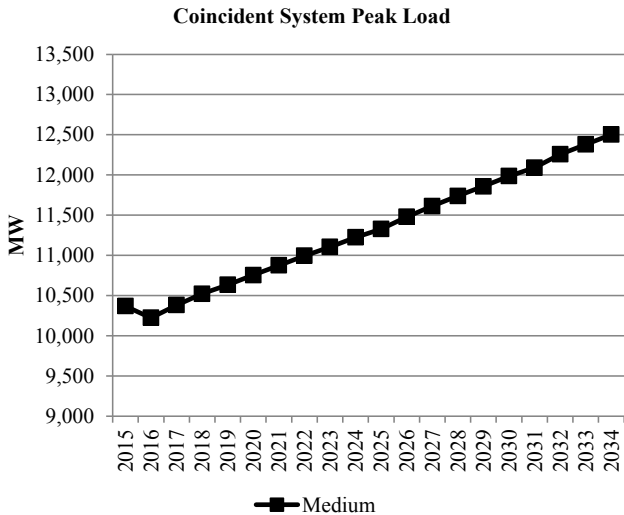

Energy Efficiency (Class 2 DSM)

Accelerated case supply curves and ramp rates with resource selections up to the achievable potential. Class 2 resources that are not selected in any given year are not available for selection in future years. Accelerated achievable potential by state and year are summarized below.

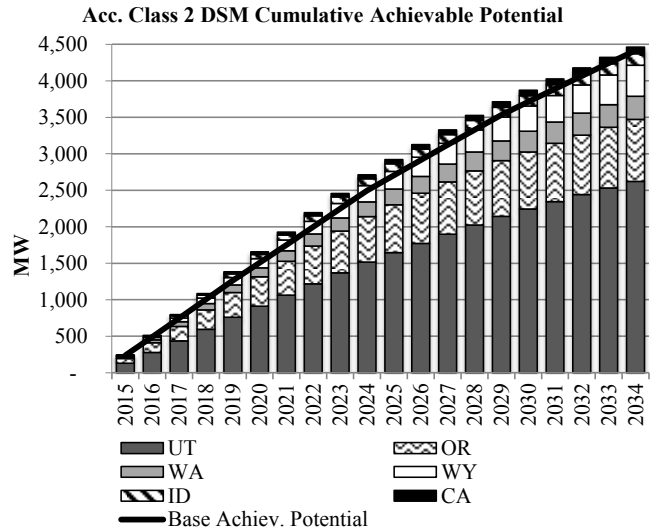

Distributed Generation

Base case distributed generation penetration is assumed in all states. Distributed generation by state and year are summarized below.

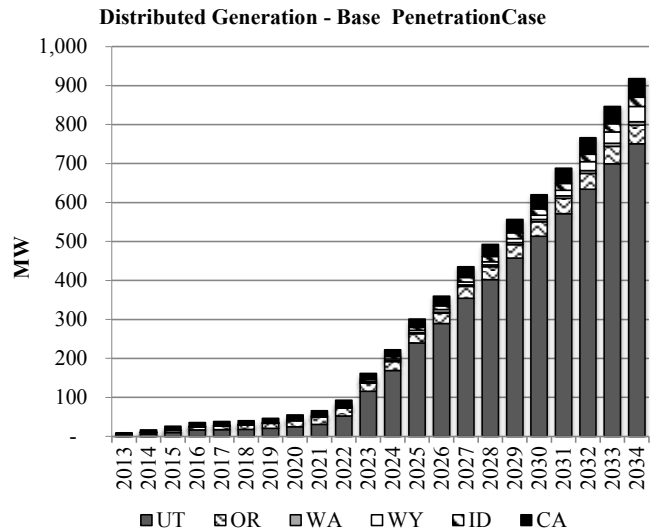

PORTFOLIO SUMMARY

System Optimizer PVRR (\$m)

System Cost without Transmission Upgrades	\$27,124
Transmission Integration	\$41
Transmission Reinforcement	\$10
Total Cost	\$27,175

Resource Portfolio

Cumulative changes to the resource portfolio (new resource additions and resource retirements), represented as nameplate capacity, are summarized in the figure below.

Case: C11-2

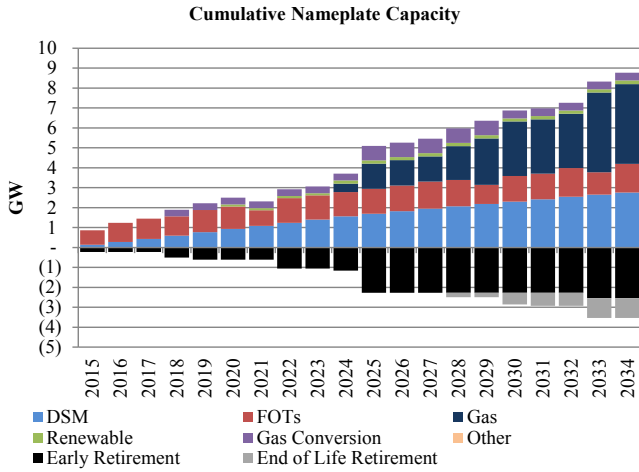

System CO₂ Emissions (System Optimizer)

System CO₂ emissions from System Optimizer are shown alongside those from Cases C01-R and C01-2 in the figure below.

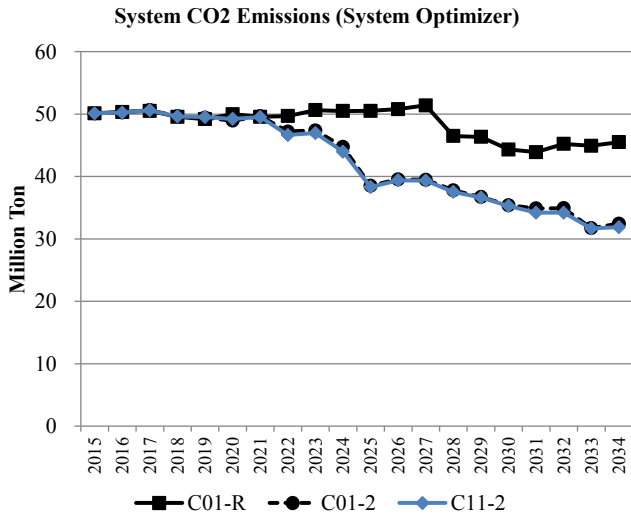

111(d) Compliance Profiles

The following figures summarize how compliance with state emission rate goals is achieved. The sum of each stacked bar represents the fossil emission rate. The net final rate represents the fossil rate after accounting for the emission rate impacts of new thermal (new NGCC units or nuclear, as applicable), re-dispatch of fossil units, energy efficiency (EE), and allocated renewable energy (RE).

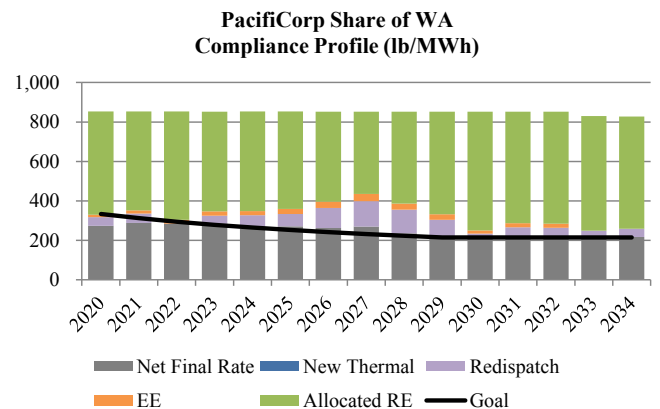
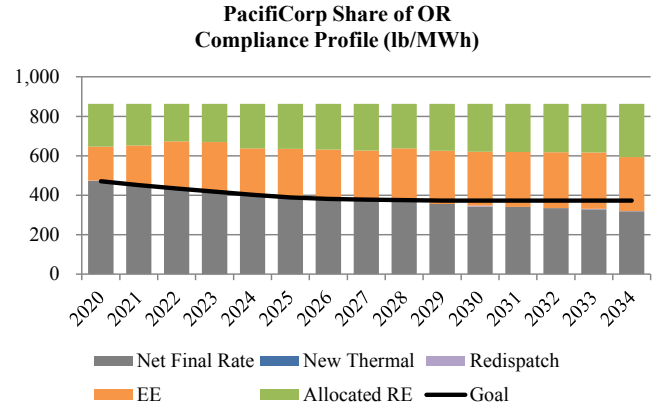
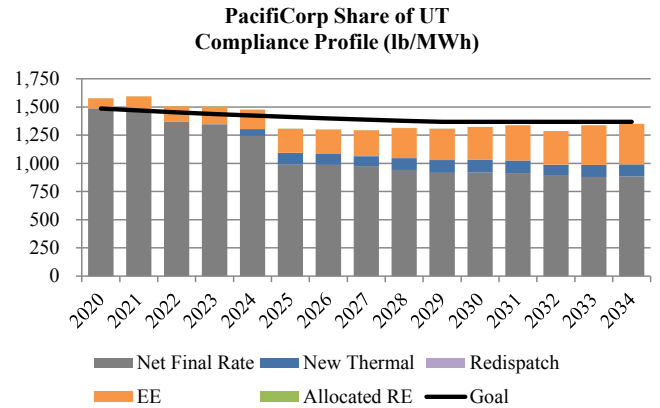
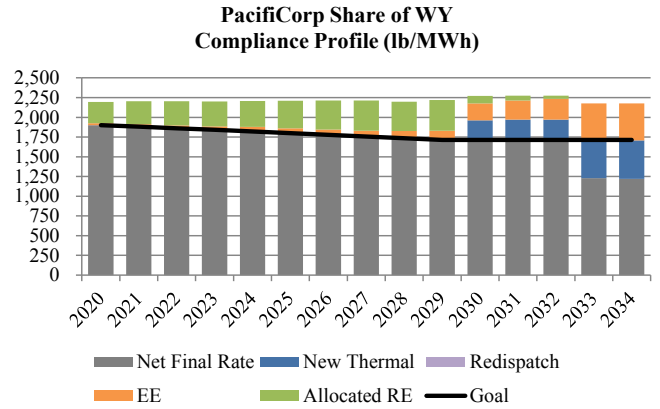

Case: C12-1

CASE ASSUMPTIONS

Description

Case C12-1 produces a portfolio that meets PacifiCorp’s share of state 111(d) emission goals in all states in which PacifiCorp has fossil generation. The 111(d) emission goals are implemented as a mass cap applied to new and existing fossil generation. For planning purposes, this case assumes one of two different Regional Haze compliance scenarios reflecting potential inter-temporal and fleet trade-off compliance outcomes.

Federal CO₂ Policy/Price Signal

C12-1 reflects EPA’s proposed 111(d) rule applied as a mass cap applicable to all new and existing fossil generation beginning 2020. No additional CO₂ price signal is applied to this case. The figure below shows the mass cap applied to this case.

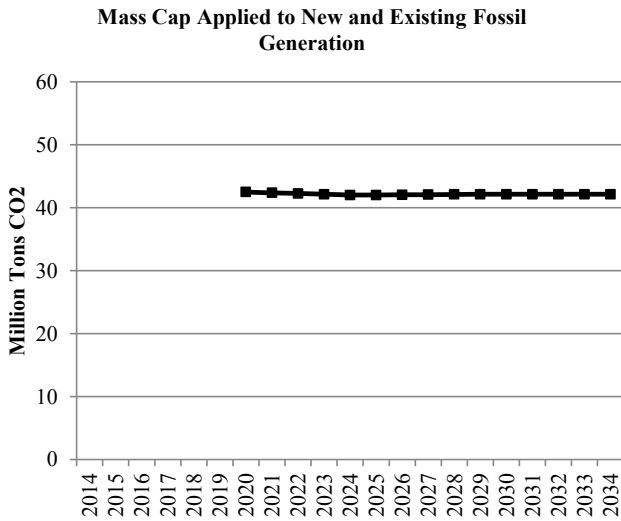

Forward Price Curve

Case C12-1 gas and power prices reflect medium natural gas prices and regional compliance with EPA’s proposed 111(d) rule as implemented in the Company’s September 2014 official forward price curve (OFPC).

Nominal Average Annual Henry Hub Gas Prices

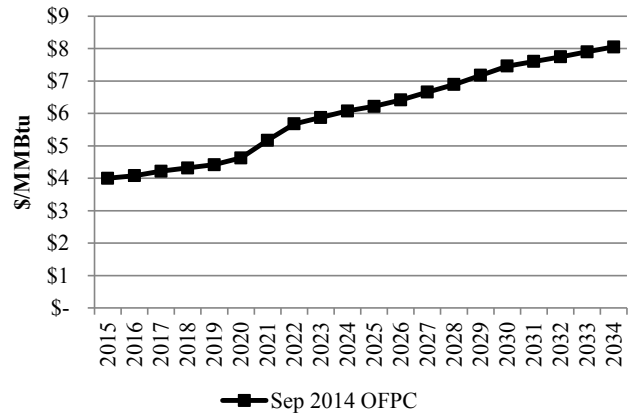

Nominal Average Annual Power Prices (Flat)

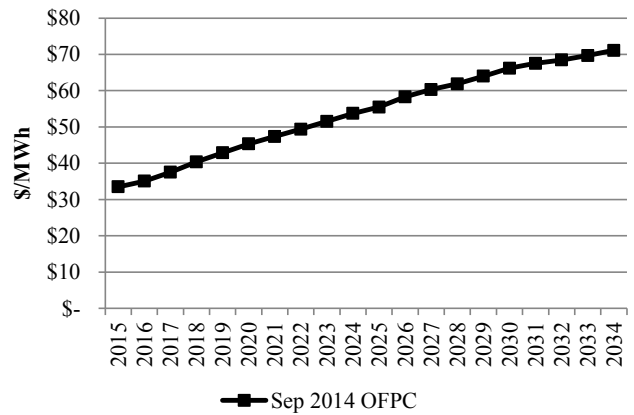

Regional Haze

Case C12-1 reflects Regional Haze Scenario 1, which assumes inter-temporal and fleet trade-off Regional Haze compliance outcomes as shown in the table below. This scenario is for planning purposes recognizing that agency, regulator, and joint owner perspectives on acceptability have not been determined.

Coal Unit	Description
Carbon 1	Shut Down Apr 2015
Carbon 2	Shut Down Apr 2015
Cholla 4	Conversion by Jun 2025
Colstrip 3	SCR by Dec 2023
Colstrip 4	SCR by Dec 2022
Craig 1	SCR by Aug 2021
Craig 2	SCR by Jan 2018
Dave Johnston 1	Shut Down Mar 2019
Dave Johnston 2	Shut Down Dec 2027
Dave Johnston 3	Shut Down Dec 2027
Dave Johnston 4	Shut Down Dec 2032
Hayden 1	SCR by Jun 2015
Hayden 2	SCR by Jun 2016
Hunter 1	SCR by Dec 2021
Hunter 2	Shut Down by Dec 2032
Hunter 3	SCR by Dec 2024
Huntington 1	Shut Down by Dec 2036

Case: C12-1

Coal Unit	Description
Huntington 2	Shut Down by Dec 2021
Jim Bridger 1	Shut Down by Dec 2023
Jim Bridger 2	Shut Down by Dec 2032
Jim Bridger 3	SCR by Dec 2015
Jim Bridger 4	SCR by Dec 2016
Naughton 1	Shut Down by Dec 2029
Naughton 2	Shut Down by Dec 2029
Naughton 3	Conversion by Jun 2018; Shut Down by Dec 2029
Wyodak	Shut Down by Dec 2039

*SCR = selective catalytic reduction

Federal Tax Incentives

- PTCs expire end of 2013
- ITC of 30% expire end of 2016, thereafter it continues in perpetuity at 10%.

Load Forecast

The figure below shows the medium system coincident peak load forecast applicable to this case before accounting for any potential contribution from DSM or distributed generation resources.

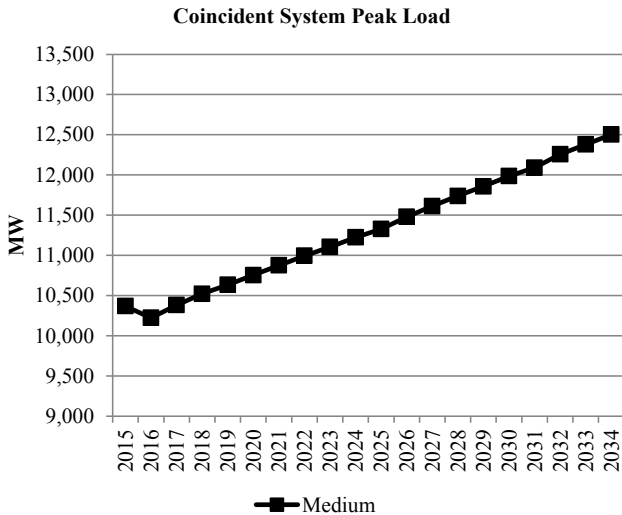

Energy Efficiency (Class 2 DSM)

This case uses base supply curves with economic resource selections up to the achievable potential. Class 2 resources that are not selected in any given year are not available for selection in future years. Achievable potential by state and year are summarized in the following figure.

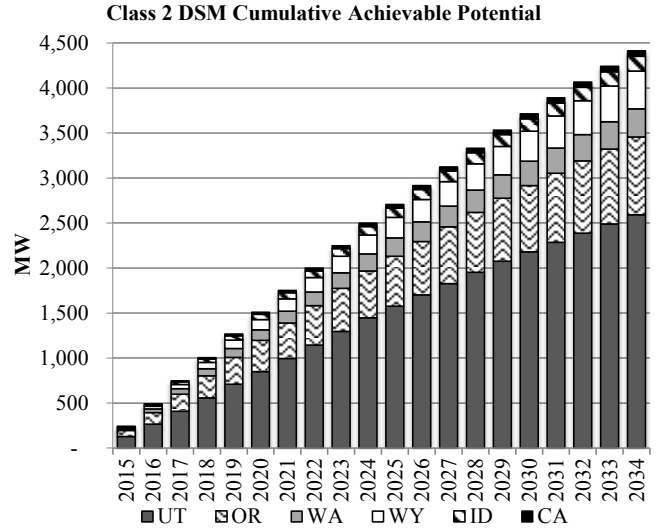

Distributed Generation

Base case distributed generation penetration is assumed in all states. Distributed generation by state and year are summarized in the following figure.

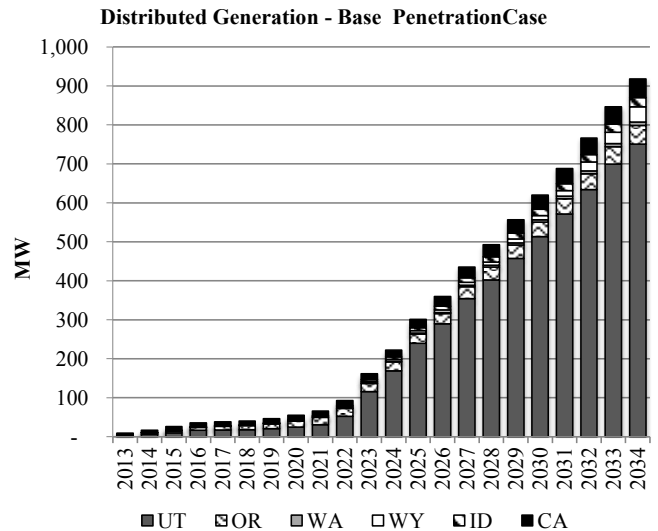

PORTFOLIO SUMMARY

System Optimizer PVRR (\$m)

System Cost without Transmission Upgrades	\$26,638
Transmission Integration	\$10
Transmission Reinforcement	\$6
Total Cost	\$26,655

Case: C12-1

Resource Portfolio

Cumulative changes to the resource portfolio (new resource additions and resource retirements), represented as nameplate capacity, are summarized in the figure below.

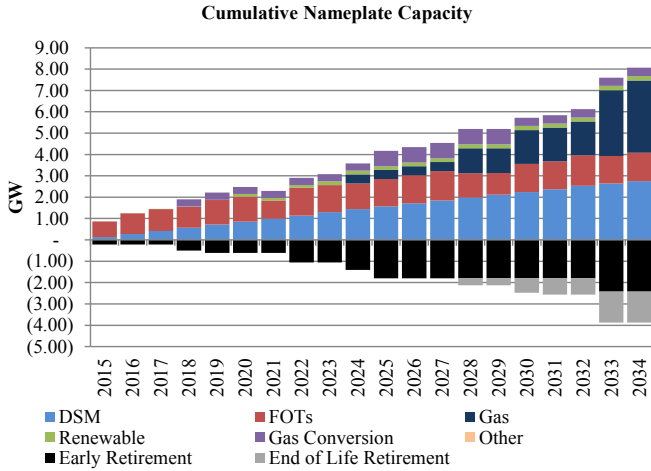

System CO₂ Emissions (System Optimizer)

System CO₂ emissions from System Optimizer are shown alongside those from Cases C01-R and C01-1 in the figure below.

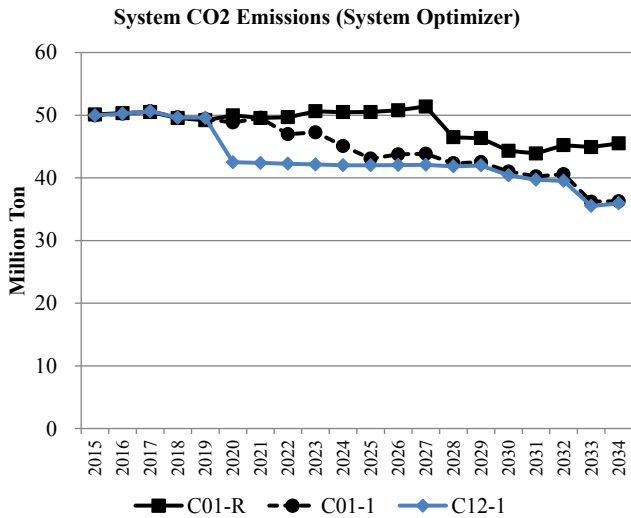

111(d) Compliance Profiles

Not applicable.

Case: C12-2

CASE ASSUMPTIONS

Description

Case C12-2 produces a portfolio that meets PacifiCorp's share of state 111(d) emission goals in all states in which PacifiCorp has fossil generation. The 111(d) emission goals are implemented as a mass cap applied to new and existing fossil generation. For planning purposes, this case assumes one of two different Regional Haze compliance scenarios reflecting potential inter-temporal and fleet trade-off compliance outcomes.

Federal CO₂ Policy/Price Signal

C12-2 reflects EPA's proposed 111(d) rule applied as a mass cap applicable to all new and existing fossil generation beginning 2020. No additional CO₂ price signal is applied to this case. The figure below shows the mass cap applied to this case.

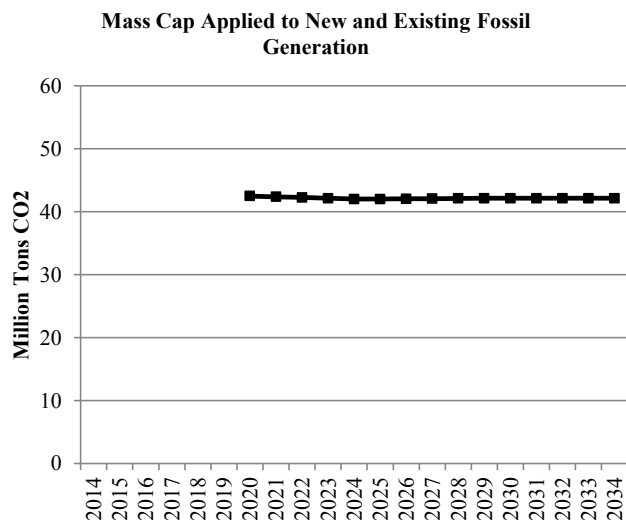

Forward Price Curve

Case C12-2 gas and power prices reflect medium natural gas prices and regional compliance with EPA's proposed 111(d) rule as implemented in the Company's September 2014 official forward price curve (OFPC).

Nominal Average Annual Henry Hub Gas Prices

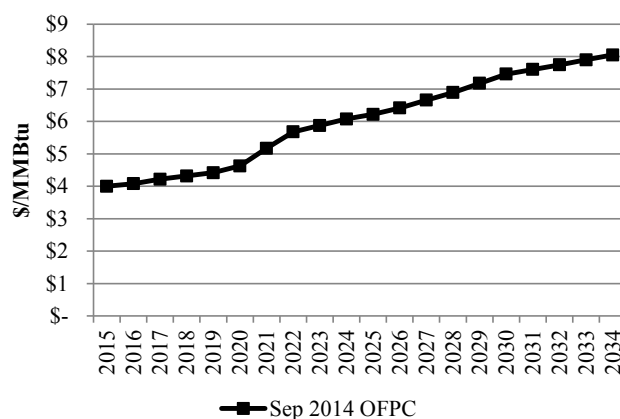

Nominal Average Annual Power Prices (Flat)

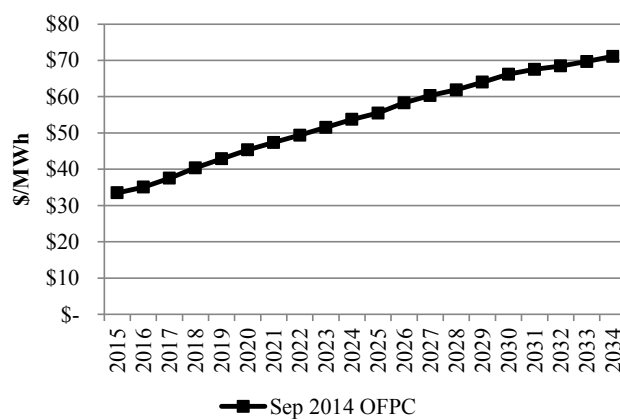

Regional Haze

Case C12-2 reflects Regional Haze Scenario 2, which assumes inter-temporal and fleet trade-off Regional Haze compliance outcomes as shown in the table below. This scenario is for planning purposes recognizing that agency, regulator, and joint owner perspectives on acceptability have not been determined.

Coal Unit	Description
Carbon 1	Shut Down Apr 2015
Carbon 2	Shut Down Apr 2015
Cholla 4	Conversion by Jun 2025
Colstrip 3	SCR by Dec 2023
Colstrip 4	SCR by Dec 2022
Craig 1	SCR by Aug 2021
Craig 2	SCR by Jan 2018
Dave Johnson 1	Shut Down Mar 2019
Dave Johnson 2	Shut Down Dec 2023
Dave Johnson 3	Shut Down Dec 2027
Dave Johnson 4	Shut Down Dec 2032
Hayden 1	SCR by Jun 2015
Hayden 2	SCR by Jun 2016
Hunter 1	SCR by Dec 2021
Hunter 2	Shut Down Dec 2024
Hunter 3	SCR by Dec 2024
Huntington 1	Shut Down Dec 2024

Case: C12-2

Coal Unit	Description
Huntington 2	Shut Down by Dec 2021
Jim Bridger 1	Shut Down by Dec 2023
Jim Bridger 2	Shut Down by Dec 2028
Jim Bridger 3	SCR by Dec 2015
Jim Bridger 4	SCR by Dec 2016
Naughton 1	Shut Down by Dec 2029
Naughton 2	Shut Down by Dec 2029
Naughton 3	Conversion by Jun 2018; Shut Down by Dec 2029
Wyodak	Shut Down by Dec 2032

* SCR = selective catalytic reduction

Federal Tax Incentives

- PTCs expire end of 2013
- ITC of 30% expire end of 2016, thereafter it continues in perpetuity at 10%.

Load Forecast

The figure below shows the medium system coincident peak load forecast applicable to this case before accounting for any potential contribution from DSM or distributed generation resources.

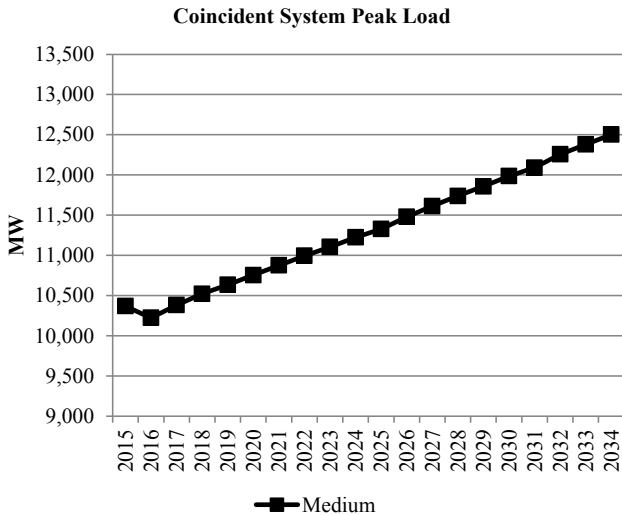

Energy Efficiency (Class 2 DSM)

This case uses base supply curves with economic resource selections up to the achievable potential. Class 2 resources that are not selected in any given year are not available for selection in future years. Achievable potential by state and year are summarized in the following figure.

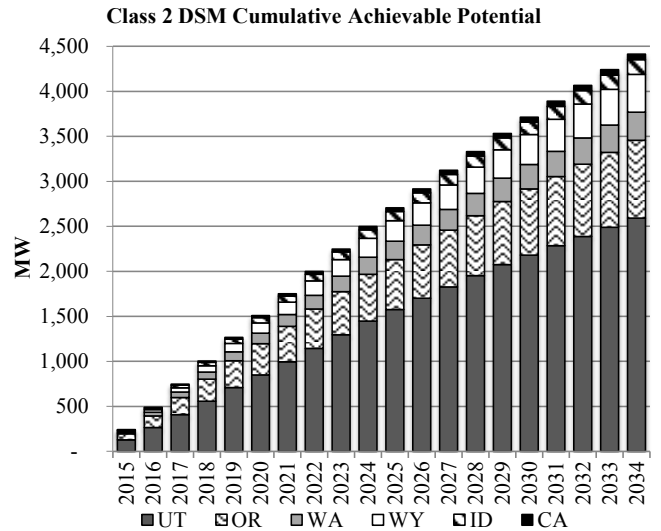

Distributed Generation

Base case distributed generation penetration is assumed in all states. Distributed generation by state and year are summarized in the following figure.

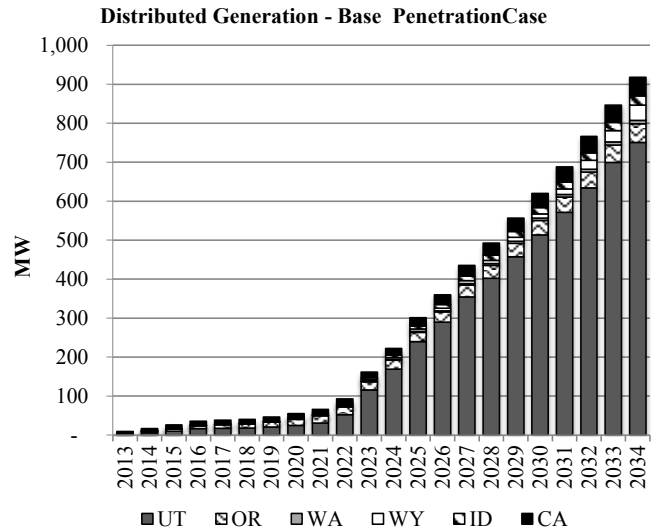

PORTFOLIO SUMMARY

System Optimizer PVRR (\$m)

System Cost without Transmission Upgrades	\$27,215
Transmission Integration	\$15
Transmission Reinforcement	\$10
Total Cost	\$27,241

Case: C12-2

Resource Portfolio

Cumulative changes to the resource portfolio (new resource additions and resource retirements), represented as nameplate capacity, are summarized in the figure below.

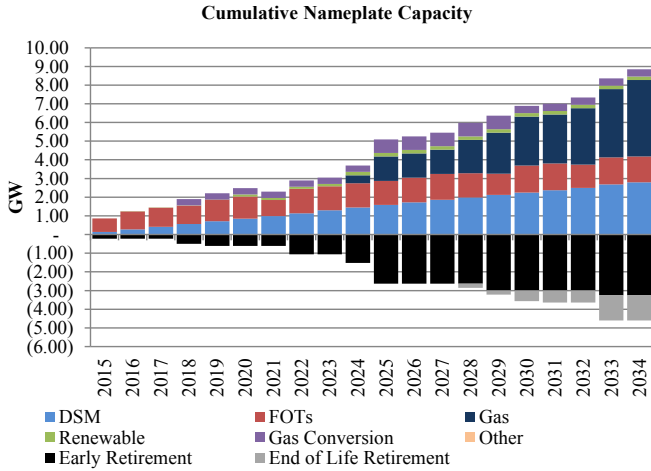

System CO₂ Emissions (System Optimizer)

System CO₂ emissions from System Optimizer are shown alongside those from Cases C01-R and C01-2 in the figure below.

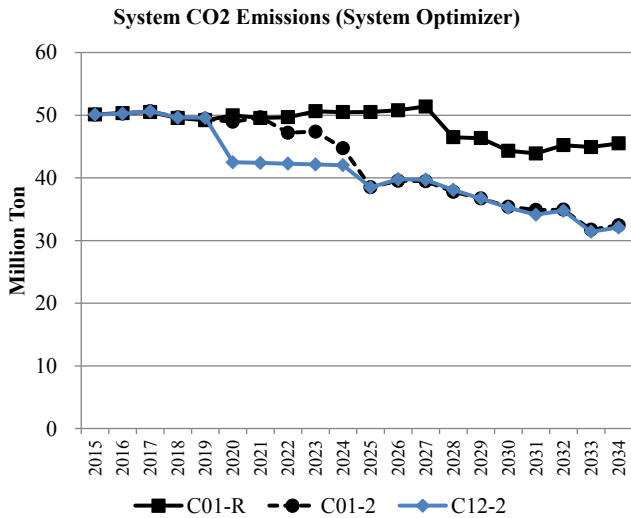

111(d) Compliance Profiles

Not applicable.

CASE ASSUMPTIONS

Description

Case C13-1 produces a portfolio that meets PacifiCorp's share of state 111(d) emission goals in all states in which PacifiCorp has fossil generation. The 111(d) emission goals are implemented as a mass cap applied to existing fossil generation. For planning purposes, this case assumes one of two different Regional Haze compliance scenarios reflecting potential inter-temporal and fleet trade-off compliance outcomes.

Federal CO₂ Policy/Price Signal

C13-1 reflects EPA's proposed 111(d) rule applied as a mass cap applicable to existing fossil generation beginning 2020. No additional CO₂ price signal is applied to this case. The figure below shows the mass cap applied to this case.

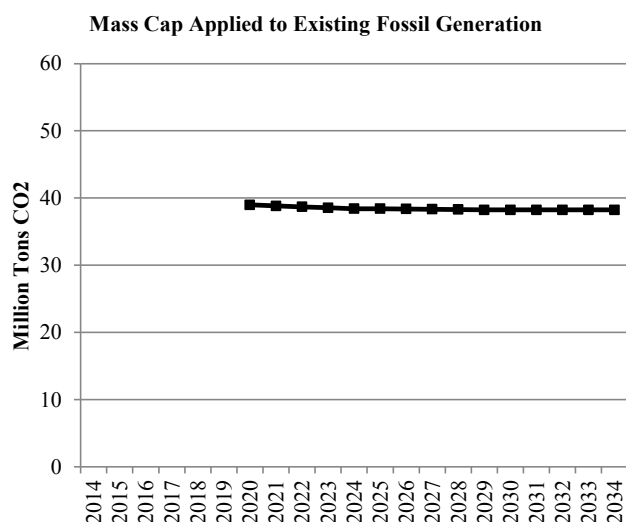

Forward Price Curve

Case C13-1 gas and power prices reflect medium natural gas prices and regional compliance with EPA's proposed 111(d) rule as implemented in the Company's September 2014 official forward price curve (OFPC).

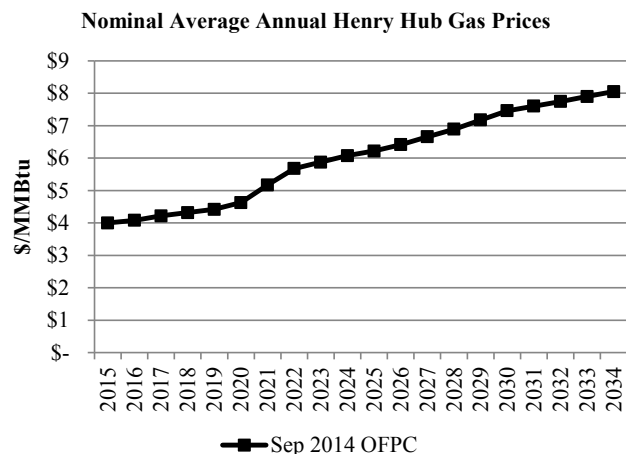

Nominal Average Annual Power Prices (Flat)

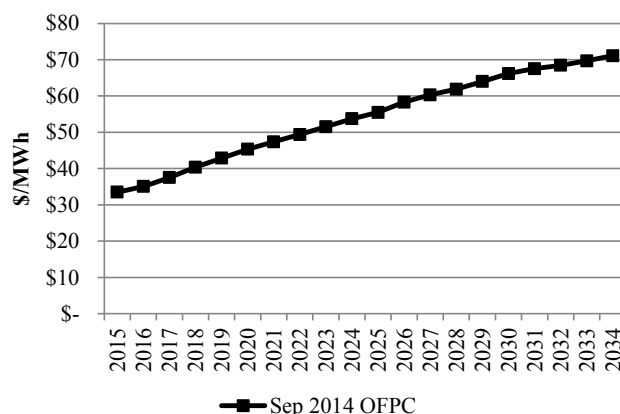

Regional Haze

Case C13-1 reflects Regional Haze Scenario 1, which assumes inter-temporal and fleet trade-off Regional Haze compliance outcomes as shown in the table below. This scenario is for planning purposes recognizing that agency, regulator, and joint owner perspectives on acceptability have not been determined.

Coal Unit	Description
Carbon 1	Shut Down Apr 2015
Carbon 2	Shut Down Apr 2015
Cholla 4	Conversion by Jun 2025
Colstrip 3	SCR by Dec 2023
Colstrip 4	SCR by Dec 2022
Craig 1	SCR by Aug 2021
Craig 2	SCR by Jan 2018
Dave Johnston 1	Shut Down Mar 2019
Dave Johnston 2	Shut Down Dec 2027
Dave Johnston 3	Shut Down Dec 2027
Dave Johnston 4	Shut Down Dec 2032
Hayden 1	SCR by Jun 2015
Hayden 2	SCR by Jun 2016
Hunter 1	SCR by Dec 2021
Hunter 2	Shut Down by Dec 2032
Hunter 3	SCR by Dec 2024
Huntington 1	Shut Down by Dec 2036
Huntington 2	Shut Down by Dec 2021
Jim Bridger 1	Shut Down by Dec 2023
Jim Bridger 2	Shut Down by Dec 2032
Jim Bridger 3	SCR by Dec 2015
Jim Bridger 4	SCR by Dec 2016
Naughton 1	Shut Down by Dec 2029
Naughton 2	Shut Down by Dec 2029
Naughton 3	Conversion by Jun 2018; Shut Down by Dec 2029
Wyodak	Shut Down by Dec 2039

*SCR = selective catalytic reduction

Federal Tax Incentives

- PTCs expire end of 2013
- ITC of 30% expire end of 2016, thereafter it continues in perpetuity at 10%.

Case: C13-1

Load Forecast

The figure below shows the medium system coincident peak load forecast applicable to this case before accounting for any potential contribution from DSM or distributed generation resources.

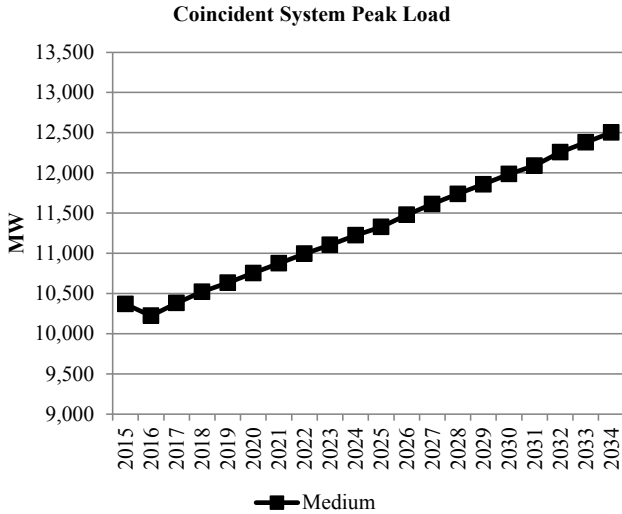

Energy Efficiency (Class 2 DSM)

This case uses base supply curves with economic resource selections up to the achievable potential. Class 2 resources that are not selected in any given year are not available for selection in future years. Achievable potential by state and year are summarized in the following figure.

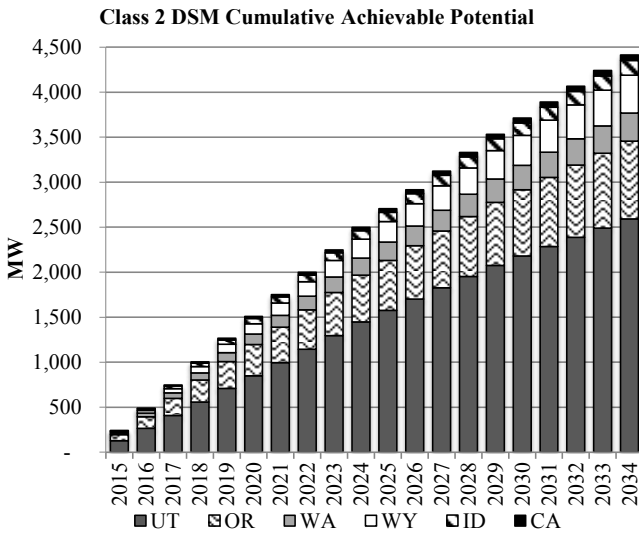

Distributed Generation

Base case distributed generation penetration is assumed in all states. Distributed generation by state and year are summarized in the following figure.

Distributed Generation - Base Penetration Case

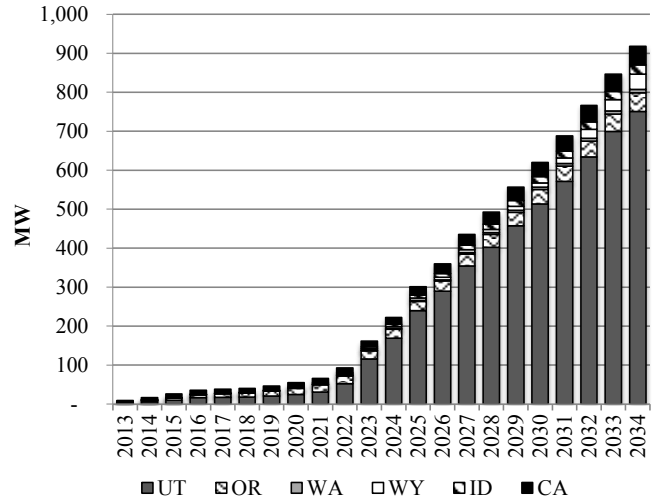

PORTFOLIO SUMMARY

System Optimizer PVRR (\$m)

System Cost without Transmission Upgrades	\$26,860
Transmission Integration	\$36
Transmission Reinforcement	\$6
Total Cost	\$26,902

Resource Portfolio

Cumulative changes to the resource portfolio (new resource additions and resource retirements), represented as nameplate capacity, are summarized in the figure below.

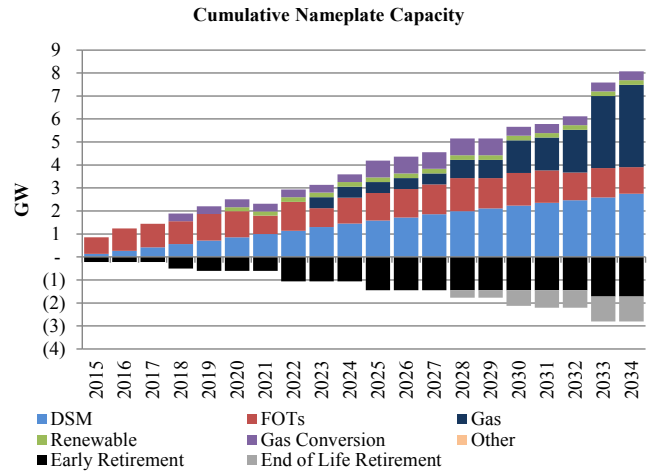

System CO₂ Emissions (System Optimizer)

System CO₂ emissions from System Optimizer are shown alongside those from Cases C01-R and C01-1 in the figure below.

Case: C13-1

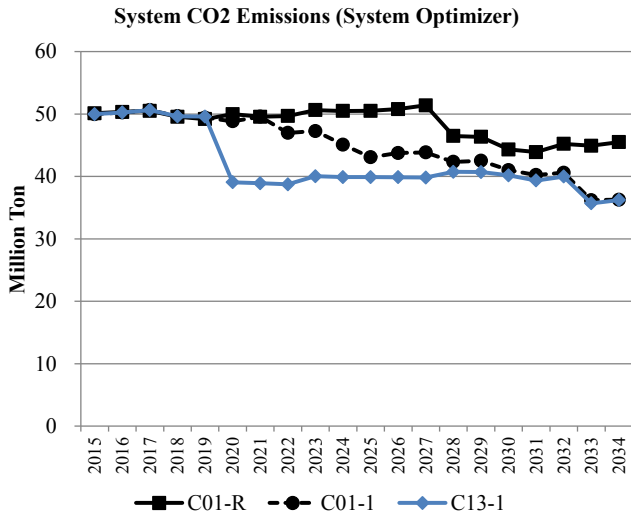

111(d) Compliance Profiles
Not applicable.

CASE ASSUMPTIONS

Description

Case C13-2 produces a portfolio that meets PacifiCorp's share of state 111(d) emission goals in all states in which PacifiCorp has fossil generation. The 111(d) emission goals are implemented as a mass cap applied to existing fossil generation. For planning purposes, this case assumes one of two different Regional Haze compliance scenarios reflecting potential inter-temporal and fleet trade-off compliance outcomes.

Federal CO₂ Policy/Price Signal

C13-2 reflects EPA's proposed 111(d) rule applied as a mass cap applicable to existing fossil generation beginning 2020. No additional CO₂ price signal is applied to this case. The figure below shows the mass cap applied to this case.

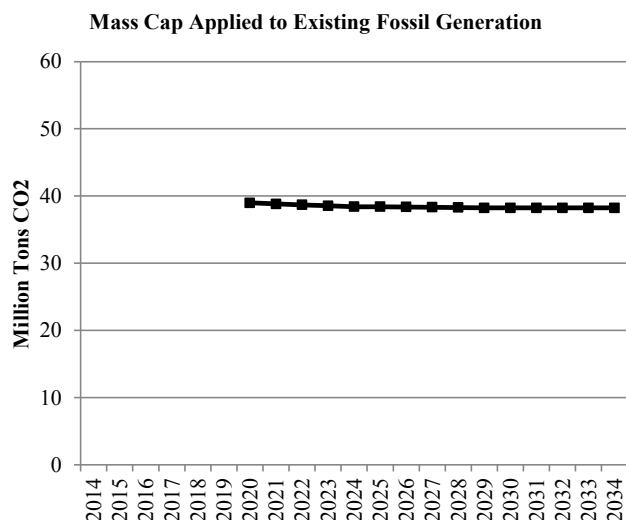

Forward Price Curve

Case C13-2 gas and power prices reflect medium natural gas prices and regional compliance with EPA's proposed 111(d) rule as implemented in the Company's September 2014 official forward price curve (OFPC).

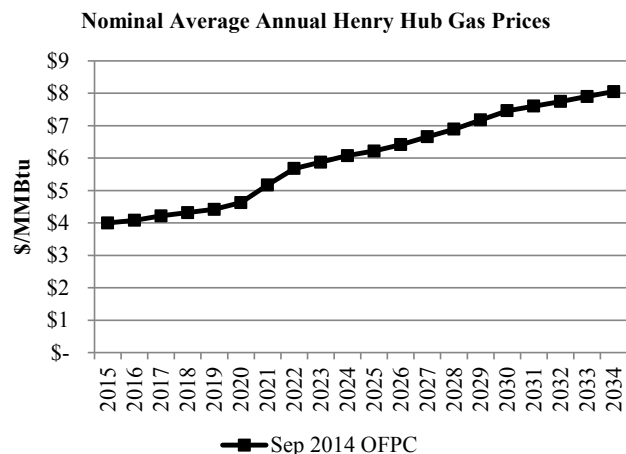

Nominal Average Annual Power Prices (Flat)

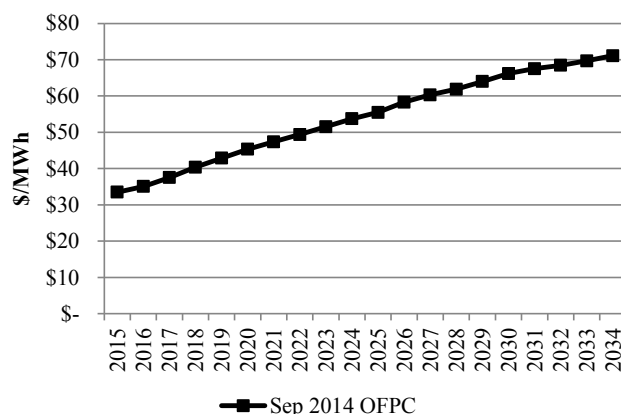

■ Sep 2014 OFPC

Regional Haze

Case C13-2 reflects Regional Haze Scenario 2, which assumes inter-temporal and fleet trade-off Regional Haze compliance outcomes as shown in the table below. This scenario is for planning purposes recognizing that agency, regulator, and joint owner perspectives on acceptability have not been determined.

Coal Unit	Description
Carbon 1	Shut Down Apr 2015
Carbon 2	Shut Down Apr 2015
Cholla 4	Conversion by Jun 2025
Colstrip 3	SCR by Dec 2023
Colstrip 4	SCR by Dec 2022
Craig 1	SCR by Aug 2021
Craig 2	SCR by Jan 2018
Dave Johnson 1	Shut Down Mar 2019
Dave Johnson 2	Shut Down Dec 2023
Dave Johnson 3	Shut Down Dec 2027
Dave Johnson 4	Shut Down Dec 2032
Hayden 1	SCR by Jun 2015
Hayden 2	SCR by Jun 2016
Hunter 1	SCR by Dec 2021
Hunter 2	Shut Down Dec 2024
Hunter 3	SCR by Dec 2024
Huntington 1	Shut Down Dec 2024
Huntington 2	Shut Down by Dec 2021
Jim Bridger 1	Shut Down by Dec 2023
Jim Bridger 2	Shut Down by Dec 2028
Jim Bridger 3	SCR by Dec 2015
Jim Bridger 4	SCR by Dec 2016
Naughton 1	Shut Down by Dec 2029
Naughton 2	Shut Down by Dec 2029
Naughton 3	Conversion by Jun 2018; Shut Down by Dec 2029
Wyodak	Shut Down by Dec 2032

*SCR = selective catalytic reduction

Federal Tax Incentives

- PTCs expire end of 2013
- ITC of 30% expire end of 2016, thereafter it continues in perpetuity at 10%.

Case: C13-2

Load Forecast

The figure below shows the medium system coincident peak load forecast applicable to this case before accounting for any potential contribution from DSM or distributed generation resources.

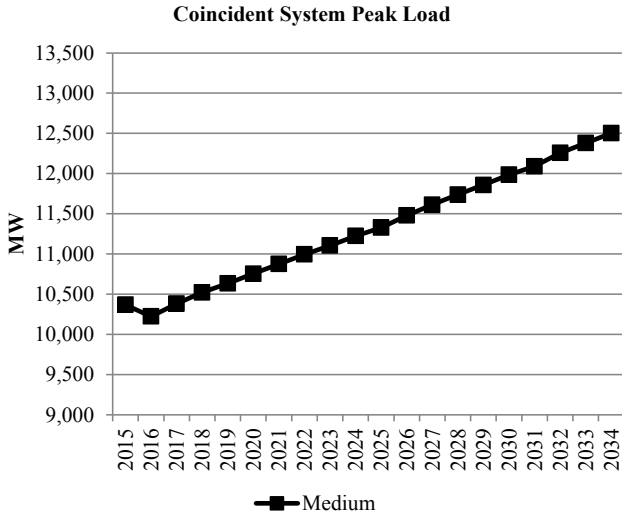

Energy Efficiency (Class 2 DSM)

This case uses base supply curves with economic resource selections up to the achievable potential. Class 2 resources that are not selected in any given year are not available for selection in future years. Achievable potential by state and year are summarized in the following figure.

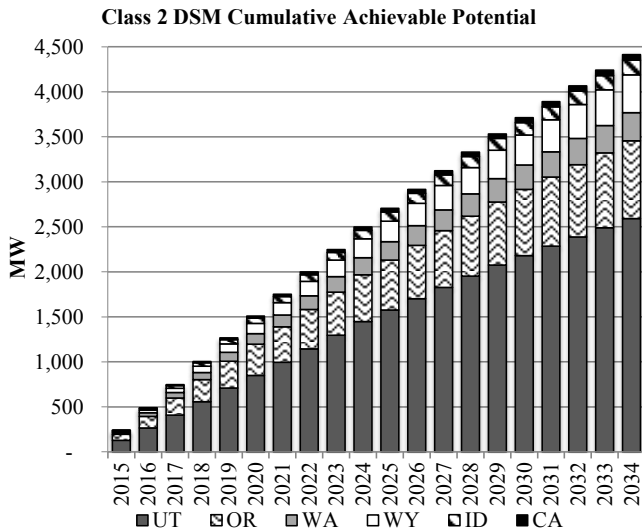

Distributed Generation

Base case distributed generation penetration is assumed in all states. Distributed generation by state and year are summarized in the following figure.

Distributed Generation - Base Penetration Case

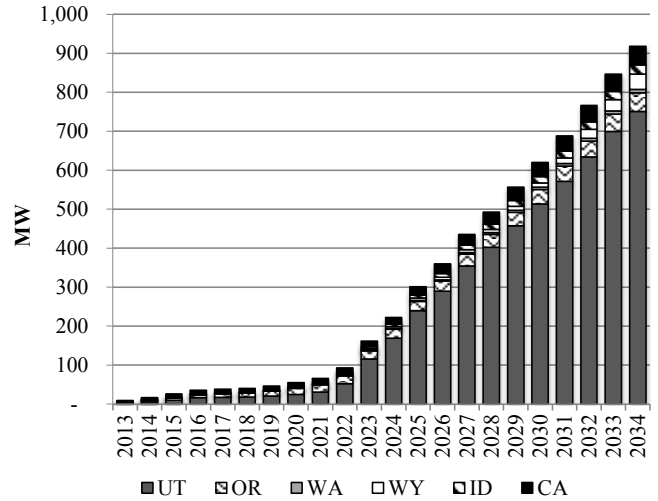

PORTFOLIO SUMMARY

System Optimizer PVRR (\$m)

System Cost without Transmission Upgrades	\$27,340
Transmission Integration	\$11
Transmission Reinforcement	\$10
Total Cost	\$27,360

Resource Portfolio

Cumulative changes to the resource portfolio (new resource additions and resource retirements), represented as nameplate capacity, are summarized in the figure below.

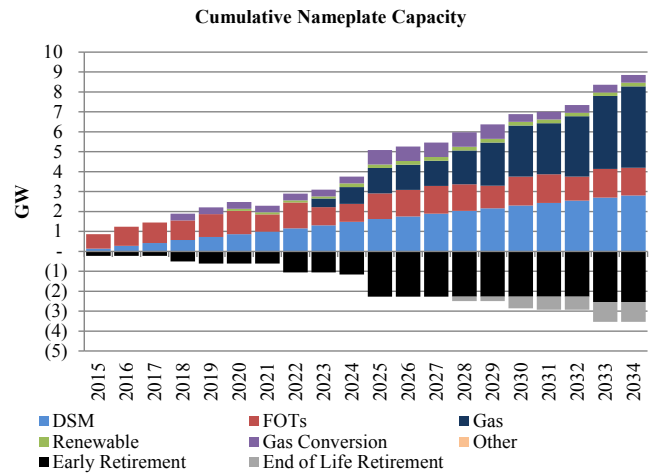

System CO₂ Emissions (System Optimizer)

System CO₂ emissions from System Optimizer are shown alongside those from Cases C01-R and C01-2 in the figure below.

Case: C13-2

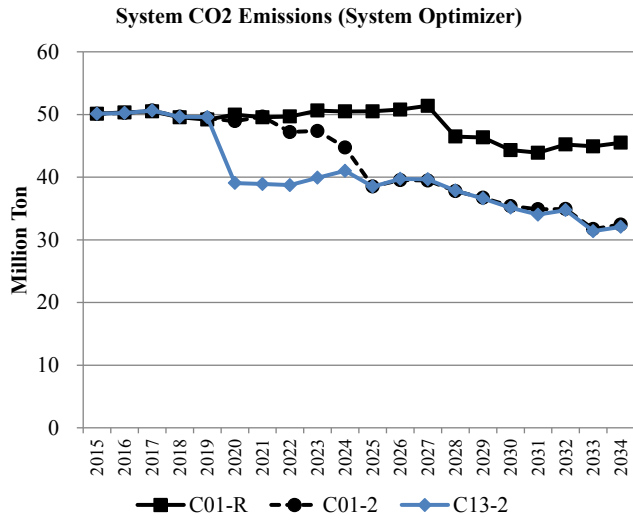

111(d) Compliance Profiles
Not applicable.

Case: C14-1

CASE ASSUMPTIONS

Description

Case C14-1 produces a portfolio that meets PacifiCorp's share of state 111(d) emission rate goals in all states in which PacifiCorp has fossil generation and retail customers. This case also includes a CO₂ price signal beginning 2020 at approximately \$22/ton rising to nearly \$76/ton by 2034. For 111(d) compliance purposes, the compliance strategy applied to this case relies on flexible allocation of renewable energy and energy efficiency while prioritizing re-dispatch of fossil generation to achieve incremental emission rate reductions as required. For planning purposes, this case assumes one of two different Regional Haze compliance scenarios reflecting potential inter-temporal and fleet trade-off compliance outcomes.

Federal CO₂ Policy/Price Signal

C14-1 reflects EPA's proposed 111(d) rule with an additional CO₂ price signal beginning 2020. The table below summarizes the interim emission rate goal and the final emission rate target by state assumed to apply to PacifiCorp's system.

State	Interim Goal (Avg. 2020-2029) (lb/MWh)	Final Target (2030 & Beyond) (lb/MWh)
WY	1,808	1,714
UT*	1,378	1,322
OR	407	372
WA	264	215

*EPA's calculation of the target for UT treated PacifiCorp's Lakeside 2 NGCC plant as an existing resource. The emission rate assumed for UT assumes Lake Side 2 is correctly classified as "under construction".

The 111(d) compliance strategy implemented for this case is summarized as follows:

- Flexible allocation of system renewable resources and flexible allocation of cumulative energy efficiency savings beginning 2017 from ID and CA, where PacifiCorp does not own fossil generation.
- Cumulative cost-effective selection of energy efficiency beginning 2017.
- New NGCC generation in WY and UT (new NGCC resources are not allowed in OR, WA, and ID).
- Re-dispatch of existing fossil generation, as required.
- Addition of new renewable resources, as required.

The CO₂ price signal applied to this case is summarized in the following figure, with prices start at about \$22/ton in 2020 rising to nearly \$76/ton by 2034.

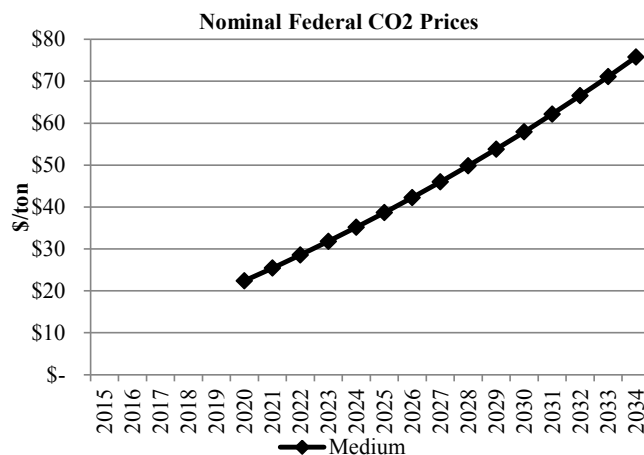

Forward Price Curve

C14-1 gas and power prices reflect medium natural gas prices adjusted for increased electric power sector demand with a national CO₂ price signal applicable to the case. Power prices include the assumed CO₂ price signal as an incremental dispatch cost for all fossil generation. The figures below summarize C14-1 gas and power prices alongside the Company's September 2014 official forward price curve (OFPC).

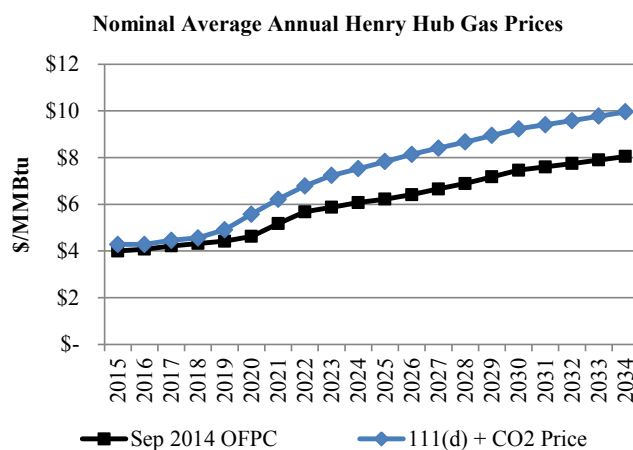

Case: C14-1

Nominal Average Annual Power Prices (Flat)

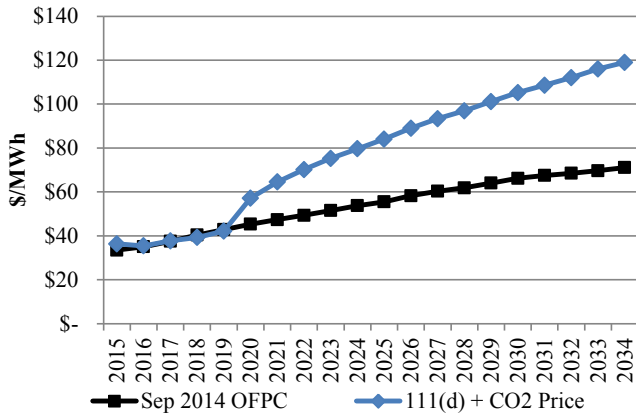

Regional Haze

Case C14-1 reflects Regional Haze Scenario 1, which assumes inter-temporal and fleet trade-off Regional Haze compliance outcomes as shown in the table below. This scenario is for planning purposes recognizing that agency, regulator, and joint owner perspectives on acceptability have not been determined.

Coal Unit	Description
Carbon 1	Shut Down Apr 2015
Carbon 2	Shut Down Apr 2015
Cholla 4	Conversion by Jun 2025
Colstrip 3	SCR by Dec 2023
Colstrip 4	SCR by Dec 2022
Craig 1	SCR by Aug 2021
Craig 2	SCR by Jan 2018
Dave Johnston 1	Shut Down Mar 2019
Dave Johnston 2	Shut Down Dec 2027
Dave Johnston 3	Shut Down Dec 2027
Dave Johnston 4	Shut Down Dec 2032
Hayden 1	SCR by Jun 2015
Hayden 2	SCR by Jun 2016
Hunter 1	SCR by Dec 2021
Hunter 2	Shut Down by Dec 2032
Hunter 3	SCR by Dec 2024
Huntington 1	Shut Down by Dec 2036
Huntington 2	Shut Down by Dec 2021
Jim Bridger 1	Shut Down by Dec 2023
Jim Bridger 2	Shut Down by Dec 2032
Jim Bridger 3	SCR by Dec 2015
Jim Bridger 4	SCR by Dec 2016
Naughton 1	Shut Down by Dec 2029
Naughton 2	Shut Down by Dec 2029
Naughton 3	Conversion by Jun 2018; Shut Down by Dec 2029
Wyodak	Shut Down by Dec 2039

*SCR = selective catalytic reduction

Federal Tax Incentives

- PTCs expire end of 2013
- ITC of 30% expire end of 2016, thereafter it continues in perpetuity at 10%.

Load Forecast

The figure below shows the medium system coincident peak load forecast applicable to this case before accounting for any potential contribution from DSM or distributed generation resources.

Coincident System Peak Load

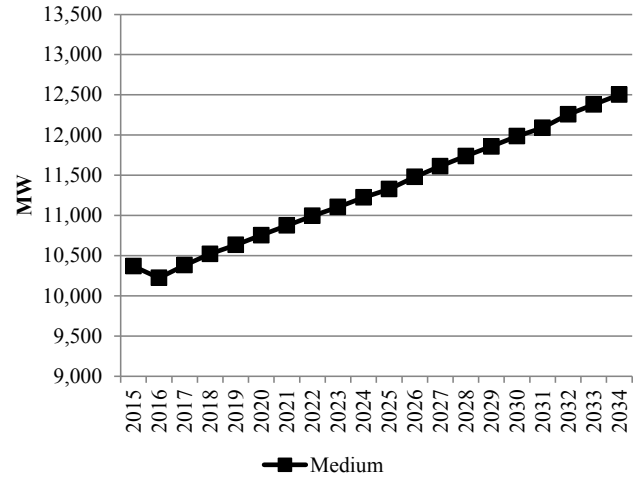

Energy Efficiency (Class 2 DSM)

This case uses base supply curves with economic resource selections up to the achievable potential. Class 2 resources that are not selected in any given year are not available for selection in future years. Achievable potential by state and year are summarized in the following figure.

Class 2 DSM Cumulative Achievable Potential

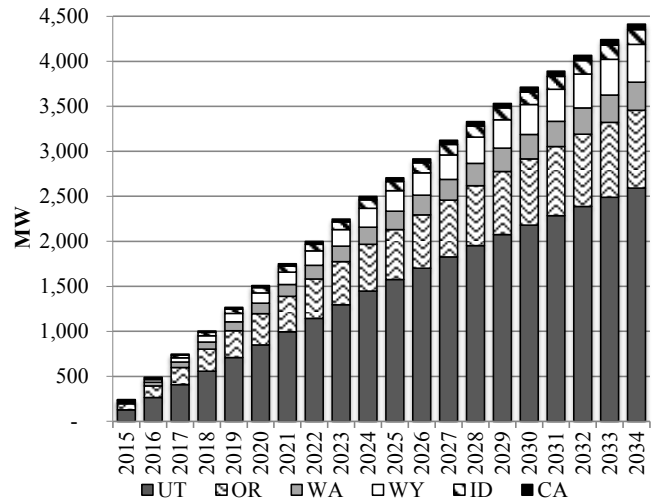

Case: C14-1

Distributed Generation

Base case distributed generation penetration is assumed in all states. Distributed generation by state and year are summarized in the following figure.

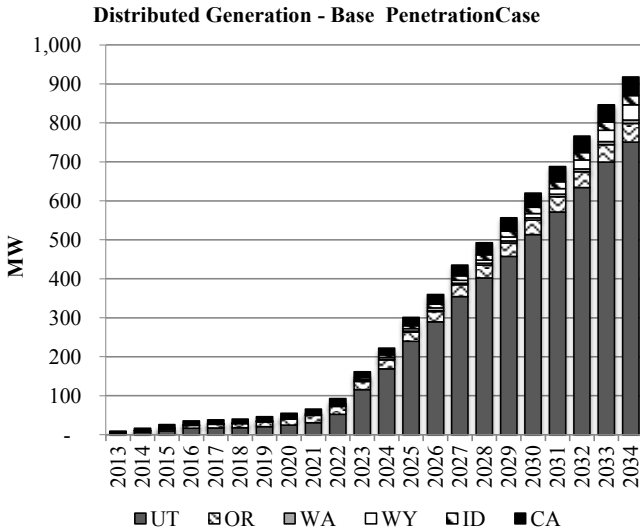

PORTFOLIO SUMMARY

System Optimizer PVRR (\$m)

System Cost without Transmission Upgrades	\$39,364
Transmission Integration	\$70
Transmission Reinforcement	\$7
Total Cost	\$39,442

Resource Portfolio

Cumulative changes to the resource portfolio (new resource additions and resource retirements), represented as nameplate capacity, are summarized in the figure below.

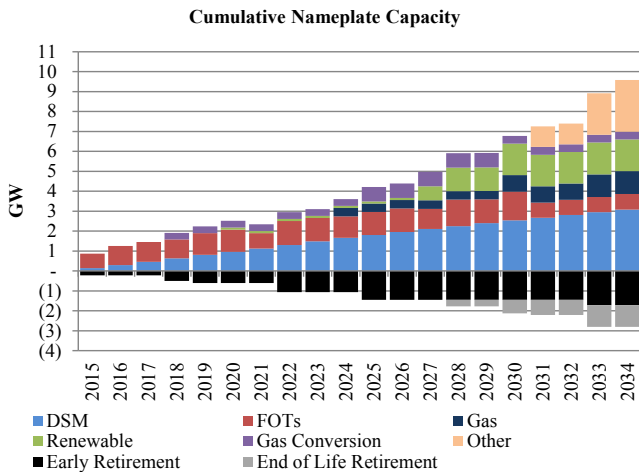

System CO₂ Emissions (System Optimizer)

System CO₂ emissions from System Optimizer are shown alongside those from Cases C01-R and C01-1 in the figure below.

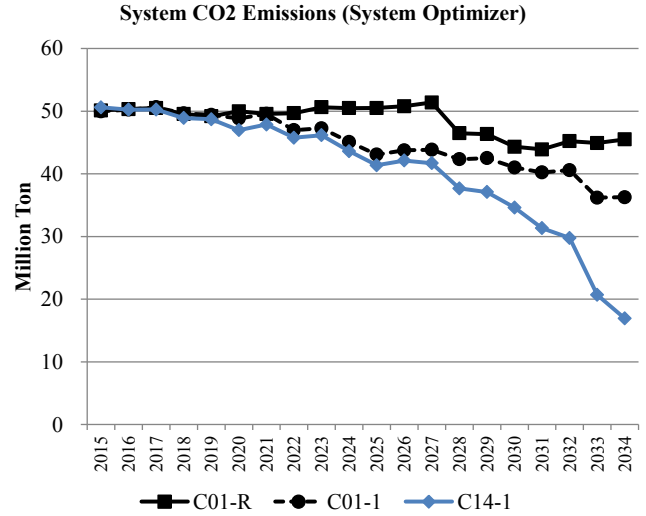

111(d) Compliance Profiles

The following figures summarize how compliance with state emission rate goals is achieved. The sum of each stacked bar represents the fossil emission rate. The net final rate represents the fossil rate after accounting for the emission rate impacts of new thermal (new NGCC units or nuclear, as applicable), re-dispatch of fossil units, energy efficiency (EE), and allocated renewable energy (RE).

PacifiCorp Share of WY Compliance Profile (lb/MWh)

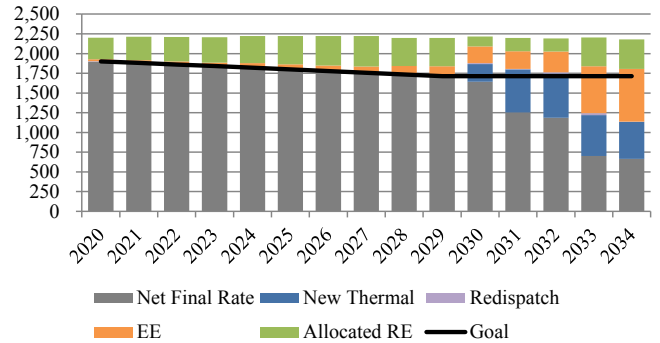

PacifiCorp Share of UT Compliance Profile (lb/MWh)

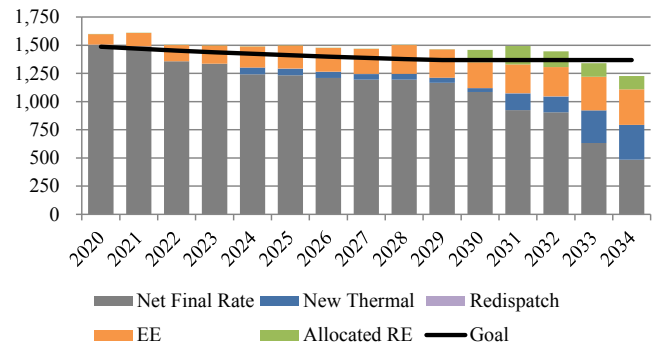

Case: C14-1

**PacifiCorp Share of OR
Compliance Profile (lb/MWh)**

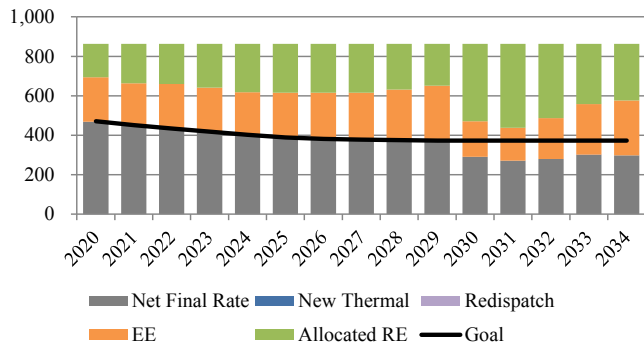

**PacifiCorp Share of WA
Compliance Profile (lb/MWh)**

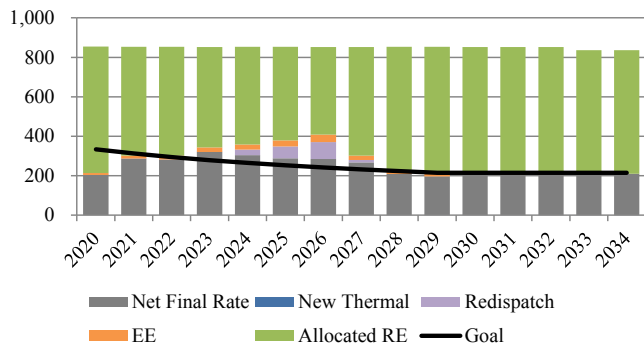

CASE ASSUMPTIONS

Description

Case C14-2 produces a portfolio that meets PacifiCorp’s share of state 111(d) emission rate goals in all states in which PacifiCorp has fossil generation and retail customers. This case also includes a CO₂ price signal beginning 2020 at approximately \$22/ton rising to nearly \$76/ton by 2034. For 111(d) compliance purposes, the compliance strategy applied to this case relies on flexible allocation of renewable energy and energy efficiency while prioritizing re-dispatch of fossil generation to achieve incremental emission rate reductions as required. For planning purposes, this case assumes one of two different Regional Haze compliance scenarios reflecting potential inter-temporal and fleet trade-off compliance outcomes.

Federal CO₂ Policy/Price Signal

C14-2 reflects EPA’s proposed 111(d) rule with an additional CO₂ price signal beginning 2020. The table below summarizes the interim emission rate goal and the final emission rate target by state assumed to apply to PacifiCorp’s system.

State	Interim Goal (Avg. 2020-2029) (lb/MWh)	Final Target (2030 & Beyond) (lb/MWh)
WY	1,808	1,714
UT*	1,378	1,322
OR	407	372
WA	264	215

*EPA’s calculation of the target for UT treated PacifiCorp’s Lakeside 2 NGCC plant as an existing resource. The emission rate assumed for UT assumes Lake Side 2 is correctly classified as “under construction”.

The 111(d) compliance strategy implemented for this case is summarized as follows:

- Flexible allocation of system renewable resources and flexible allocation of cumulative energy efficiency savings beginning 2017 from ID and CA, where PacifiCorp does not own fossil generation.
- Cumulative cost-effective selection of energy efficiency beginning 2017.
- New NGCC generation in WY and UT (new NGCC resources are not allowed in OR, WA, and ID).
- Re-dispatch of existing fossil generation, as required.
- Addition of new renewable resources, as required.

The CO₂ price signal applied to this case is summarized in the following figure, with prices start at about \$22/ton in 2020 rising to nearly \$76/ton by 2034.

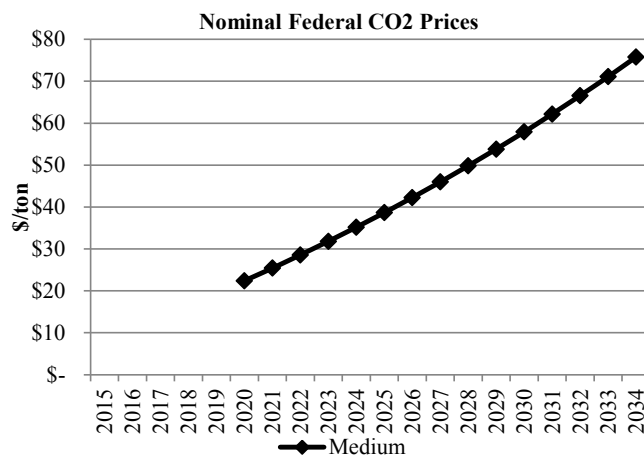

Forward Price Curve

C14-2 gas and power prices reflect medium natural gas prices adjusted for increased electric power sector demand with a national CO₂ price signal applicable to the case. Power prices include the assumed CO₂ price signal as an incremental dispatch cost for all fossil generation. The figures below summarize C14-2 gas and power prices alongside the Company’s September 2014 official forward price curve (OFPC).

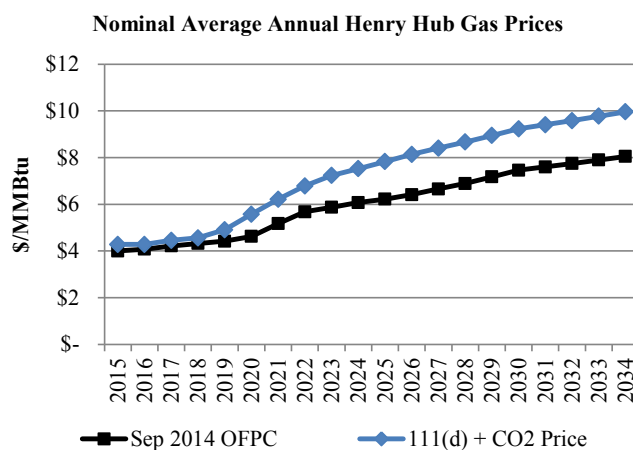

Case: C14-2

Nominal Average Annual Power Prices (Flat)

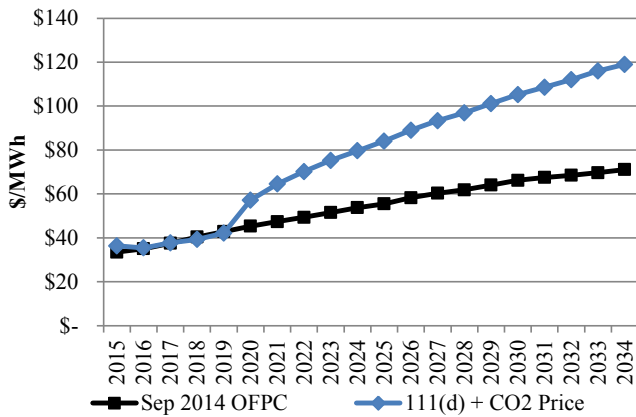

Regional Haze

Case C14-2 reflects Regional Haze Scenario 2, which assumes inter-temporal and fleet trade-off Regional Haze compliance outcomes as shown in the table below. This scenario is for planning purposes recognizing that agency, regulator, and joint owner perspectives on acceptability have not been determined.

Coal Unit	Description
Carbon 1	Shut Down Apr 2015
Carbon 2	Shut Down Apr 2015
Cholla 4	Conversion by Jun 2025
Colstrip 3	SCR by Dec 2023
Colstrip 4	SCR by Dec 2022
Craig 1	SCR by Aug 2021
Craig 2	SCR by Jan 2018
Dave Johnson 1	Shut Down Mar 2019
Dave Johnson 2	Shut Down Dec 2023
Dave Johnson 3	Shut Down Dec 2027
Dave Johnson 4	Shut Down Dec 2032
Hayden 1	SCR by Jun 2015
Hayden 2	SCR by Jun 2016
Hunter 1	SCR by Dec 2021
Hunter 2	Shut Down Dec 2024
Hunter 3	SCR by Dec 2024
Huntington 1	Shut Down Dec 2024
Huntington 2	Shut Down by Dec 2021
Jim Bridger 1	Shut Down by Dec 2023
Jim Bridger 2	Shut Down by Dec 2028
Jim Bridger 3	SCR by Dec 2015
Jim Bridger 4	SCR by Dec 2016
Naughton 1	Shut Down by Dec 2029
Naughton 2	Shut Down by Dec 2029
Naughton 3	Conversion by Jun 2018; Shut Down by Dec 2029
Wyodak	Shut Down by Dec 2032

*SCR = selective catalytic reduction

Federal Tax Incentives

- PTCs expire end of 2013

- ITC of 30% expire end of 2016, thereafter it continues in perpetuity at 10%.

Load Forecast

The figure below shows the medium system coincident peak load forecast applicable to this case before accounting for any potential contribution from DSM or distributed generation resources.

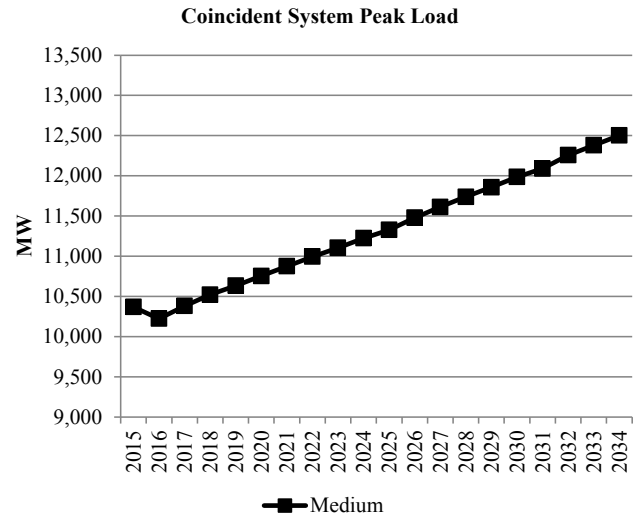

Energy Efficiency (Class 2 DSM)

This case uses base supply curves with economic resource selections up to the achievable potential. Class 2 resources that are not selected in any given year are not available for selection in future years. Achievable potential by state and year are summarized in the following figure.

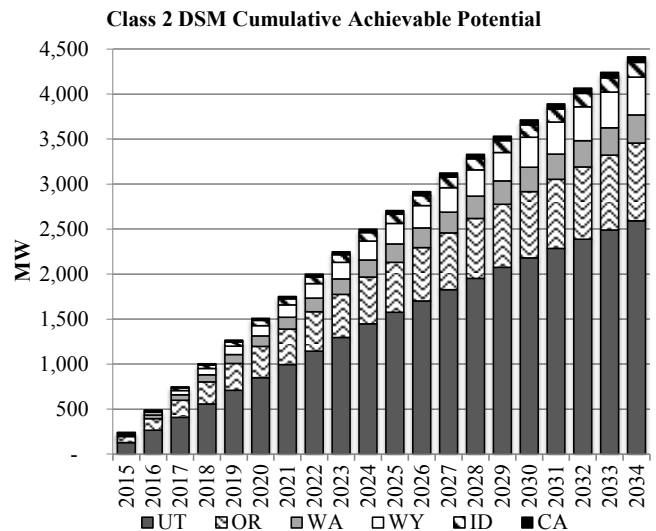

Distributed Generation

Base case distributed generation penetration is assumed in all states. Distributed generation by state and year are summarized in the following figure.

Case: C14-2

Distributed Generation - Base PenetrationCase

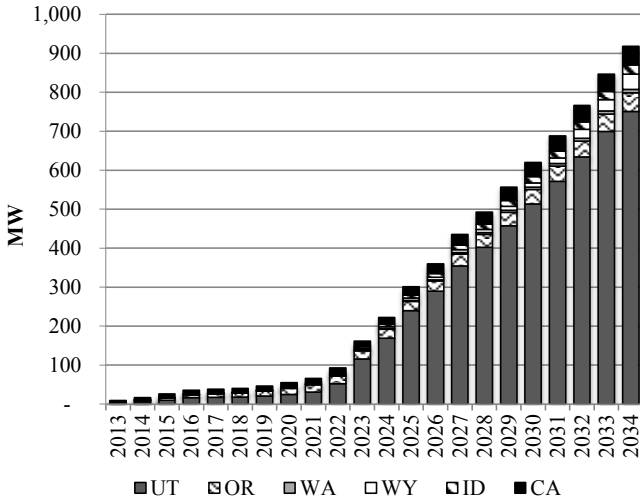

System CO2 Emissions (System Optimizer)

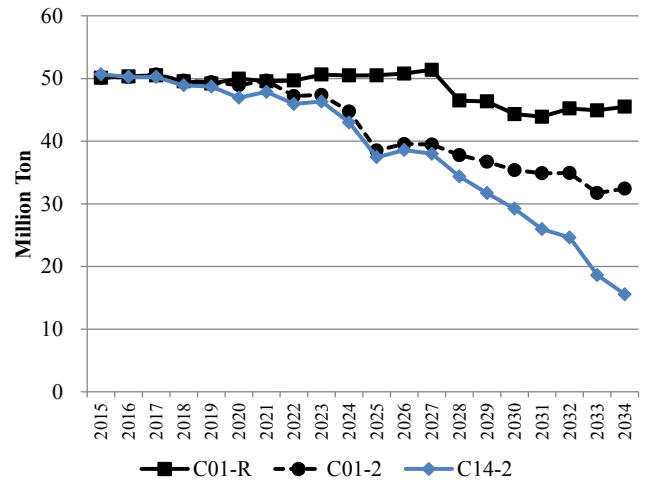

PORTFOLIO SUMMARY

System Optimizer PVRR (\$m)

System Cost without Transmission Upgrades	\$39,342
Transmission Integration	\$230
Transmission Reinforcement	\$13
Total Cost	\$39,584

Resource Portfolio

Cumulative changes to the resource portfolio (new resource additions and resource retirements), represented as nameplate capacity, are summarized in the figure below.

Cumulative Nameplate Capacity

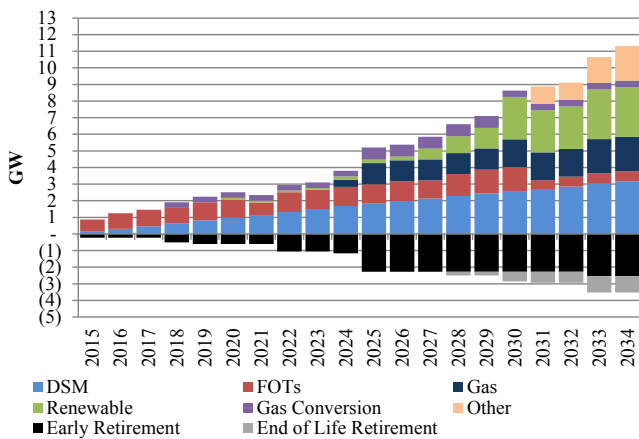

111(d) Compliance Profiles

The following figures summarize how compliance with state emission rate goals is achieved. The sum of each stacked bar represents the fossil emission rate. The net final rate represents the fossil rate after accounting for the emission rate impacts of new thermal (new NGCC units or nuclear, as applicable), re-dispatch of fossil units, energy efficiency (EE), and allocated renewable energy (RE).

PacifiCorp Share of WY Compliance Profile (lb/MWh)

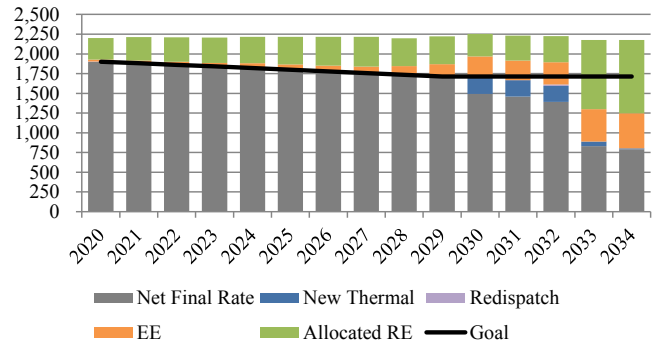

PacifiCorp Share of UT Compliance Profile (lb/MWh)

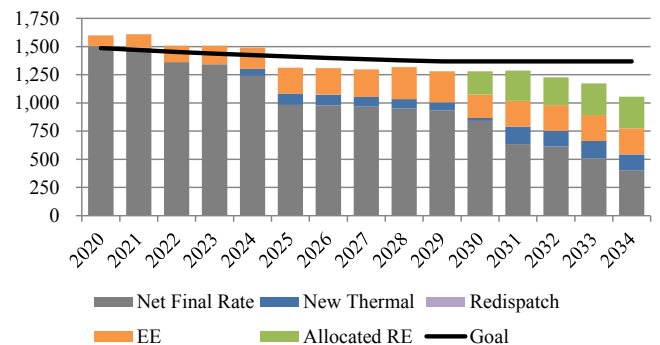

System CO₂ Emissions (System Optimizer)

System CO₂ emissions from System Optimizer are shown alongside those from Cases C01-R and C01-2 in the figure below.

Case: C14-2

**PacifiCorp Share of OR
Compliance Profile (lb/MWh)**

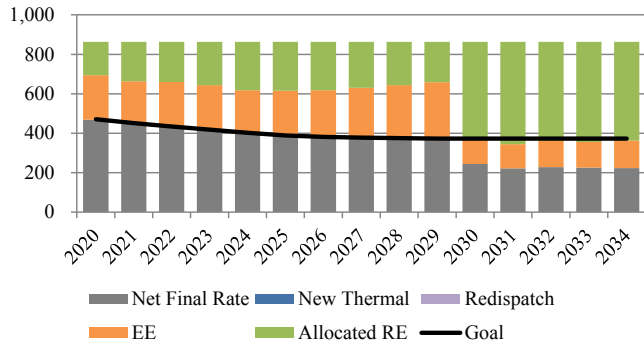

**PacifiCorp Share of WA
Compliance Profile (lb/MWh)**

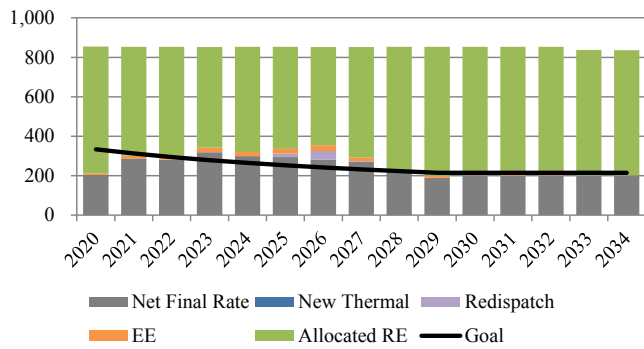

Case: C14a-1

CASE ASSUMPTIONS

Description

Case C14a-1 is an alternative to Case C14-1 in which endogenous coal unit retirements for coal units not already assumed to retire early for Regional Haze compliance purposes is allowed. This case produces a portfolio that meets PacifiCorp's share of state 111(d) emission rate goals in all states in which PacifiCorp has fossil generation and retail customers. This case also includes a CO₂ price signal beginning 2020 at approximately \$22/ton rising to nearly \$76/ton by 2034. For 111(d) compliance purposes, the compliance strategy applied to this case relies on flexible allocation of renewable energy and energy efficiency while prioritizing re-dispatch of fossil generation to achieve incremental emission rate reductions as required. For planning purposes, this case assumes one of two different Regional Haze compliance scenarios reflecting potential inter-temporal and fleet trade-off compliance outcomes.

Federal CO₂ Policy/Price Signal

C14a-1 reflects EPA's proposed 111(d) rule with an additional CO₂ price signal beginning 2020. The table below summarizes the interim emission rate goal and the final emission rate target by state assumed to apply to PacifiCorp's system.

State	Interim Goal (Avg. 2020-2029) (lb/MWh)	Final Target (2030 & Beyond) (lb/MWh)
WY	1,808	1,714
UT*	1,378	1,322
OR	407	372
WA	264	215

*EPA's calculation of the target for UT treated PacifiCorp's Lakeside 2 NGCC plant as an existing resource. The emission rate assumed for UT assumes Lake Side 2 is correctly classified as "under construction".

The 111(d) compliance strategy implemented for this case is summarized as follows:

- Flexible allocation of system renewable resources and flexible allocation of cumulative energy efficiency savings beginning 2017 from ID and CA, where PacifiCorp does not own fossil generation.
- Cumulative cost-effective selection of energy efficiency beginning 2017.
- New NGCC generation in WY and UT (new NGCC resources are not allowed in OR, WA, and ID).
- Re-dispatch of existing fossil generation, as required.
- Addition of new renewable resources, as required.

The CO₂ price signal applied to this case is summarized in the following figure, with prices start at about \$22/ton in 2020 rising to nearly \$76/ton by 2034.

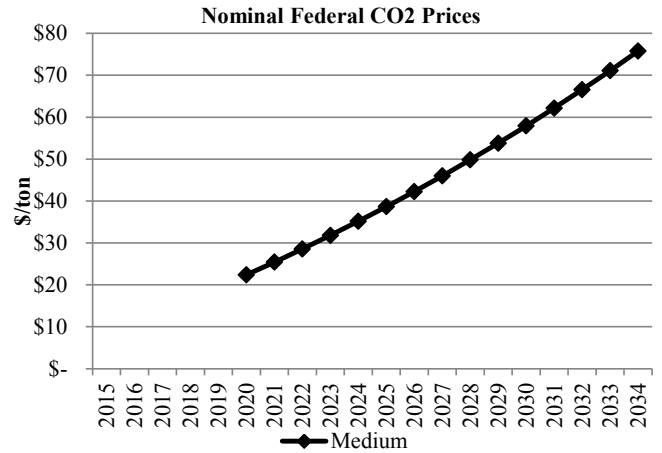

Forward Price Curve

C14a-1 gas and power prices reflect medium natural gas prices adjusted for increased electric power sector demand with a national CO₂ price signal applicable to the case. Power prices include the assumed CO₂ price signal as an incremental dispatch cost for all fossil generation. The figures below summarize C14a-1 gas and power prices alongside the Company's September 2014 official forward price curve (OFPC).

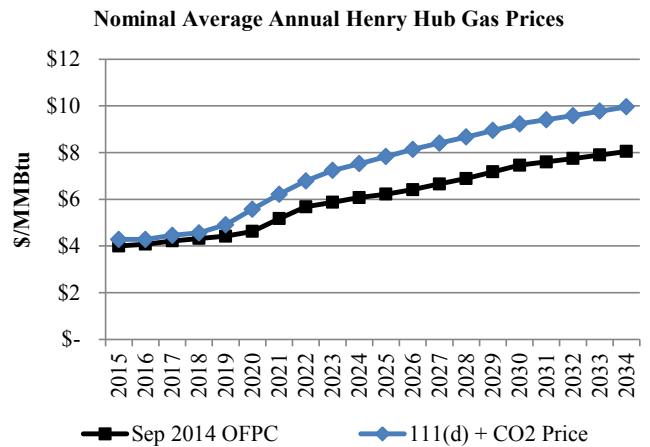

Case: C14a-1

Nominal Average Annual Power Prices (Flat)

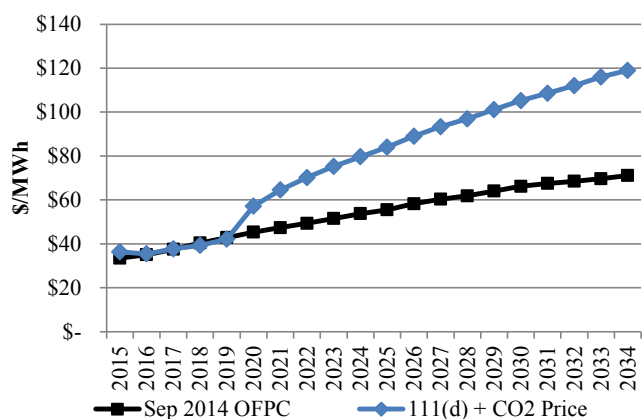

Regional Haze

Case C14a-1 reflects Regional Haze Scenario 1, which assumes inter-temporal and fleet trade-off Regional Haze compliance outcomes as shown in the table below. This scenario is for planning purposes recognizing that agency, regulator, and joint owner perspectives on acceptability have not been determined.

Coal Unit	Description
Carbon 1	Shut Down Apr 2015
Carbon 2	Shut Down Apr 2015
Cholla 4	Conversion by Jun 2025
Colstrip 3	SCR by Dec 2023
Colstrip 4	SCR by Dec 2022
Craig 1	SCR by Aug 2021
Craig 2	SCR by Jan 2018
Dave Johnston 1	Shut Down Mar 2019
Dave Johnston 2	Shut Down Dec 2027
Dave Johnston 3	Shut Down Dec 2027
Dave Johnston 4	Shut Down Dec 2032
Hayden 1	SCR by Jun 2015
Hayden 2	SCR by Jun 2016
Hunter 1	SCR by Dec 2021
Hunter 2	Shut Down by Dec 2032
Hunter 3	SCR by Dec 2024
Huntington 1	Shut Down by Dec 2036
Huntington 2	Shut Down by Dec 2021
Jim Bridger 1	Shut Down by Dec 2023
Jim Bridger 2	Shut Down by Dec 2032
Jim Bridger 3	SCR by Dec 2015
Jim Bridger 4	SCR by Dec 2016
Naughton 1	Shut Down by Dec 2029
Naughton 2	Shut Down by Dec 2029
Naughton 3	Conversion by Jun 2018; Shut Down by Dec 2029
Wyodak	Shut Down by Dec 2039

*SCR = selective catalytic reduction

Federal Tax Incentives

- PTCs expire end of 2013
- ITC of 30% expire end of 2016, thereafter it continues in perpetuity at 10%.

Load Forecast

This case uses base supply curves with economic resource selections up to the achievable potential. Class 2 resources that are not selected in any given year are not available for selection in future years. Achievable potential by state and year are summarized in the following figure.

Coincident System Peak Load

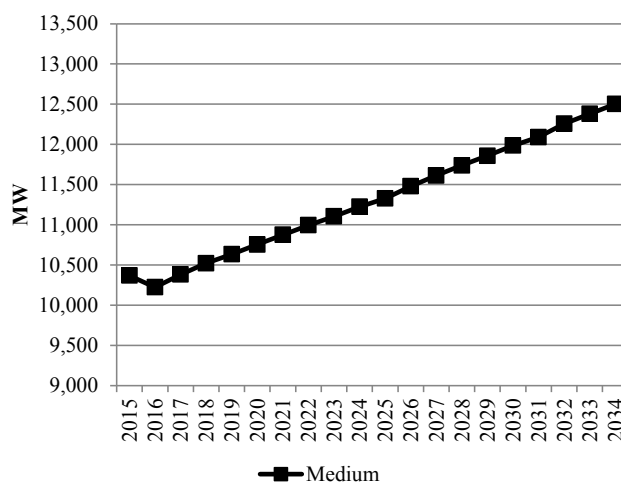

Energy Efficiency (Class 2 DSM)

This case uses base supply curves with economic resource selections up to the achievable potential. Class 2 resources that are not selected in any given year are not available for selection in future years. Achievable potential by state and year are summarized in the following figure.

Class 2 DSM Cumulative Achievable Potential

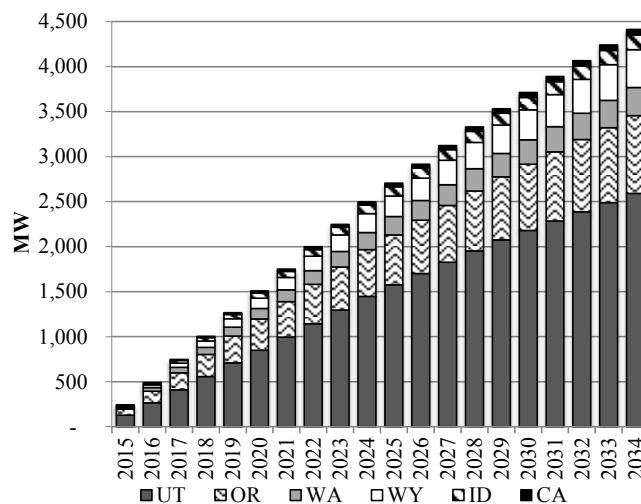

Case: C14a-1

Distributed Generation

Base case distributed generation penetration is assumed in all states. Distributed generation by state and year are summarized in the following figure.

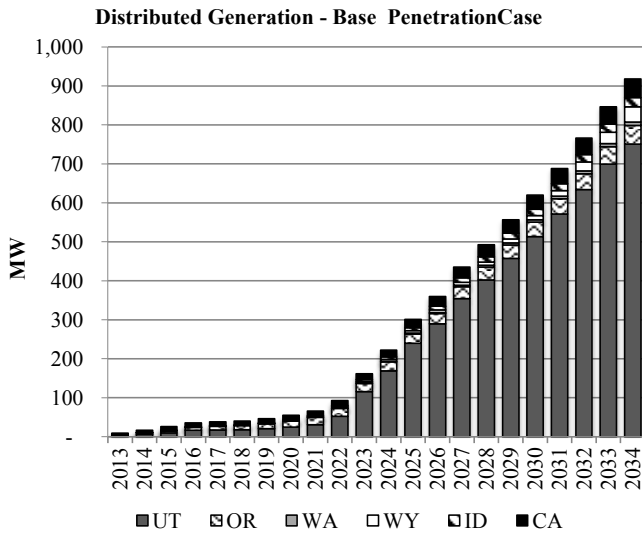

PORTFOLIO SUMMARY

System Optimizer PVRR (\$m)

System Cost without Transmission Upgrades	\$39,229
Transmission Integration	\$69
Transmission Reinforcement	\$7
Total Cost	\$39,304

Resource Portfolio

Cumulative changes to the resource portfolio (new resource additions and resource retirements), represented as nameplate capacity, are summarized in the figure below.

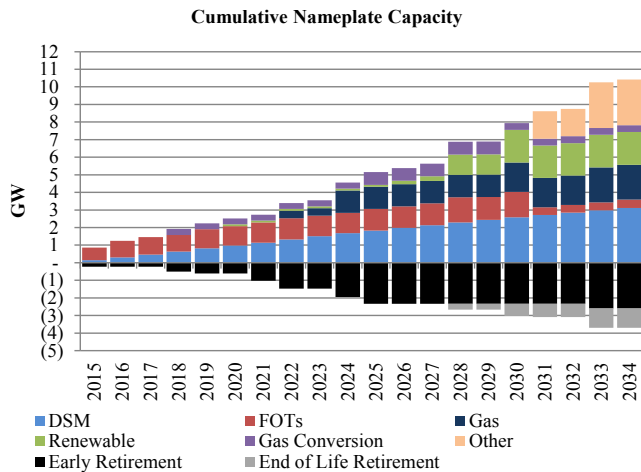

System CO₂ Emissions (System Optimizer)

System CO₂ emissions from System Optimizer are shown alongside those from Cases C01-R and C01-1 in the following figure.

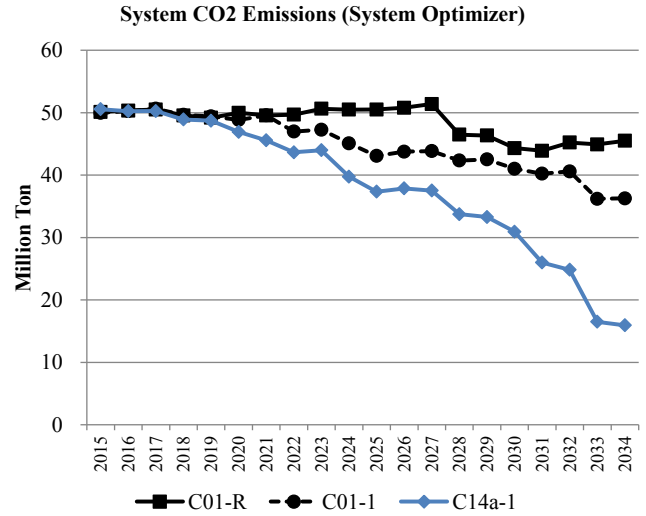

111(d) Compliance Profiles

The following figures summarize how compliance with state emission rate goals is achieved. The sum of each stacked bar represents the fossil emission rate. The net final rate represents the fossil rate after accounting for the emission rate impacts of new thermal (new NGCC units or nuclear, as applicable), re-dispatch of fossil units, energy efficiency (EE), and allocated renewable energy (RE).

PacifiCorp Share of WY Compliance Profile (lb/MWh)

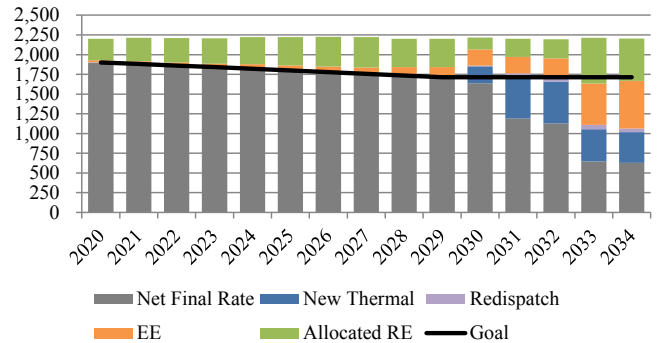

PacifiCorp Share of UT Compliance Profile (lb/MWh)

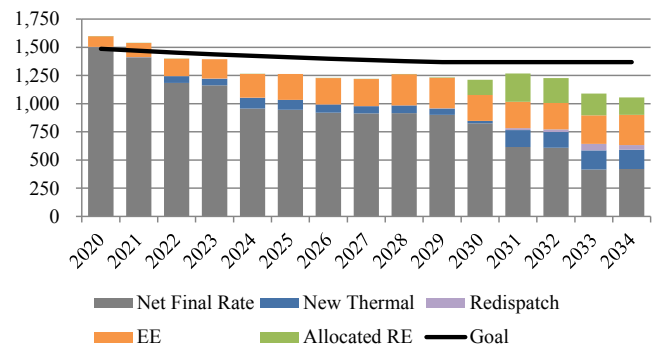

Case: C14a-1

**PacifiCorp Share of OR
Compliance Profile (lb/MWh)**

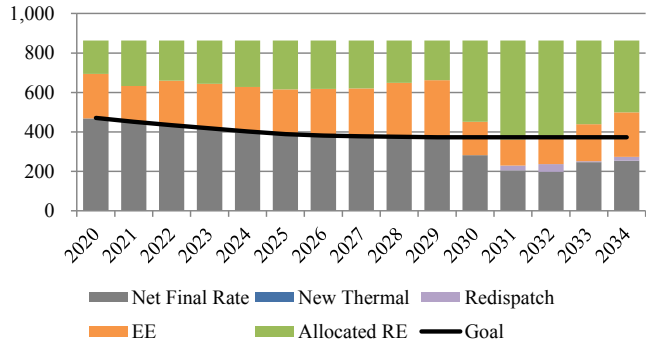

**PacifiCorp Share of WA
Compliance Profile (lb/MWh)**

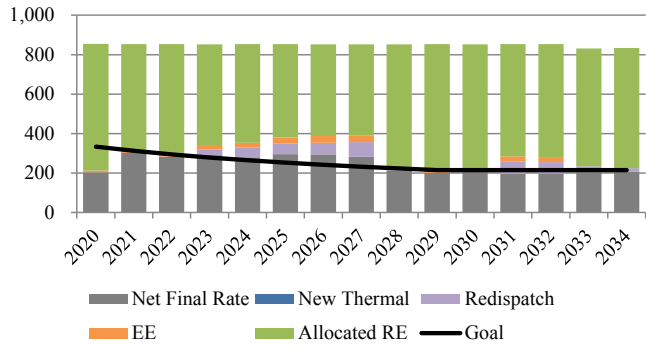

Case C14a-2

CASE ASSUMPTIONS

Description

Case C14a-2 is an alternative to Case C14-2 in which endogenous coal unit retirements for coal units not already assumed to retire early for Regional Haze compliance purposes is allowed. This case produces a portfolio that meets PacifiCorp’s share of state 111(d) emission rate goals in all states in which PacifiCorp has fossil generation and retail customers. This case also includes a CO₂ price signal beginning 2020 at approximately \$22/ton rising to nearly \$76/ton by 2034. For 111(d) compliance purposes, the compliance strategy applied to this case relies on flexible allocation of renewable energy and energy efficiency while prioritizing re-dispatch of fossil generation to achieve incremental emission rate reductions as required. For planning purposes, this case assumes one of two different Regional Haze compliance scenarios reflecting potential inter-temporal and fleet trade-off compliance outcomes.

Federal CO₂ Policy/Price Signal

C14a-2 reflects EPA’s proposed 111(d) rule with an additional CO₂ price signal beginning 2020. The table below summarizes the interim emission rate goal and the final emission rate target by state assumed to apply to PacifiCorp’s system.

State	Interim Goal (Avg. 2020-2029) (lb/MWh)	Final Target (2030 & Beyond) (lb/MWh)
WY	1,808	1,714
UT*	1,378	1,322
OR	407	372
WA	264	215

*EPA’s calculation of the target for UT treated PacifiCorp’s Lakeside 2 NGCC plant as an existing resource. The emission rate assumed for UT assumes Lake Side 2 is correctly classified as “under construction”.

The 111(d) compliance strategy implemented for this case is summarized as follows:

- Flexible allocation of system renewable resources and flexible allocation of cumulative energy efficiency savings beginning 2017 from ID and CA, where PacifiCorp does not own fossil generation.
- Cumulative cost-effective selection of energy efficiency beginning 2017.
- New NGCC generation in WY and UT (new NGCC resources are not allowed in OR, WA, and ID).
- Re-dispatch of existing fossil generation, as required.
- Addition of new renewable resources, as required.

The CO₂ price signal applied to this case is summarized in the following figure, with prices start at about \$22/ton in 2020 rising to nearly \$76/ton by 2034.

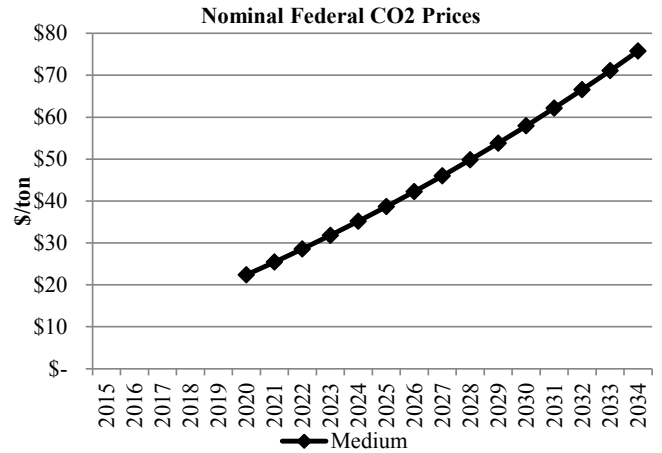

Forward Price Curve

C14a-2 gas and power prices reflect medium natural gas prices adjusted for increased electric power sector demand with a national CO₂ price signal applicable to the case. Power prices include the assumed CO₂ price signal as an incremental dispatch cost for all fossil generation. The figures below summarize C14a-2 gas and power prices alongside the Company’s September 2014 official forward price curve (OFPC).

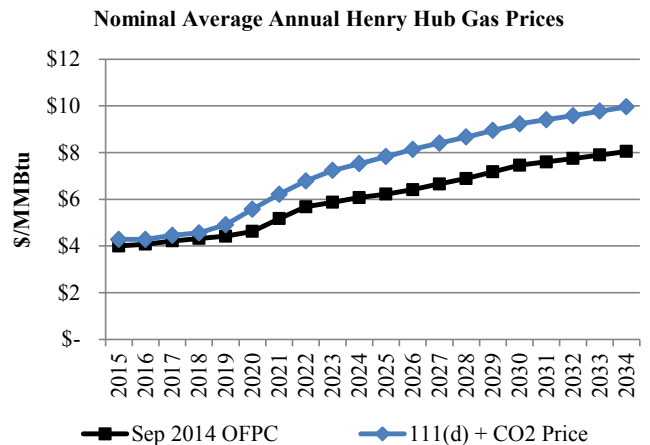

Case C14a-2

Nominal Average Annual Power Prices (Flat)

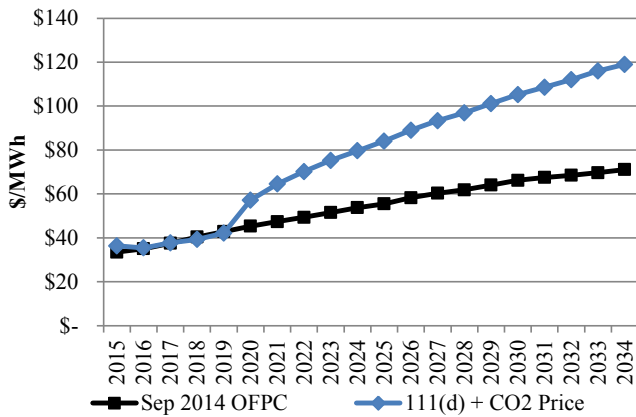

Regional Haze

Case C14a-2 reflects Regional Haze Scenario 2, which assumes inter-temporal and fleet trade-off Regional Haze compliance outcomes as shown in the table below. This scenario is for planning purposes recognizing that agency, regulator, and joint owner perspectives on acceptability have not been determined.

Coal Unit	Description
Carbon 1	Shut Down Apr 2015
Carbon 2	Shut Down Apr 2015
Cholla 4	Conversion by Jun 2025
Colstrip 3	SCR by Dec 2023
Colstrip 4	SCR by Dec 2022
Craig 1	SCR by Aug 2021
Craig 2	SCR by Jan 2018
Dave Johnson 1	Shut Down Mar 2019
Dave Johnson 2	Shut Down Dec 2023
Dave Johnson 3	Shut Down Dec 2027
Dave Johnson 4	Shut Down Dec 2032
Hayden 1	SCR by Jun 2015
Hayden 2	SCR by Jun 2016
Hunter 1	SCR by Dec 2021
Hunter 2	Shut Down Dec 2024
Hunter 3	SCR by Dec 2024
Huntington 1	Shut Down Dec 2024
Huntington 2	Shut Down by Dec 2021
Jim Bridger 1	Shut Down by Dec 2023
Jim Bridger 2	Shut Down by Dec 2028
Jim Bridger 3	SCR by Dec 2015
Jim Bridger 4	SCR by Dec 2016
Naughton 1	Shut Down by Dec 2029
Naughton 2	Shut Down by Dec 2029
Naughton 3	Conversion by Jun 2018; Shut Down by Dec 2029
Wyodak	Shut Down by Dec 2032

*SCR = selective catalytic reduction

Federal Tax Incentives

- PTCs expire end of 2013
- ITC of 30% expire end of 2016, thereafter it continues in perpetuity at 10%.

Load Forecast

This case uses base supply curves with economic resource selections up to the achievable potential. Class 2 resources that are not selected in any given year are not available for selection in future years. Achievable potential by state and year are summarized in the following figure.

Coincident System Peak Load

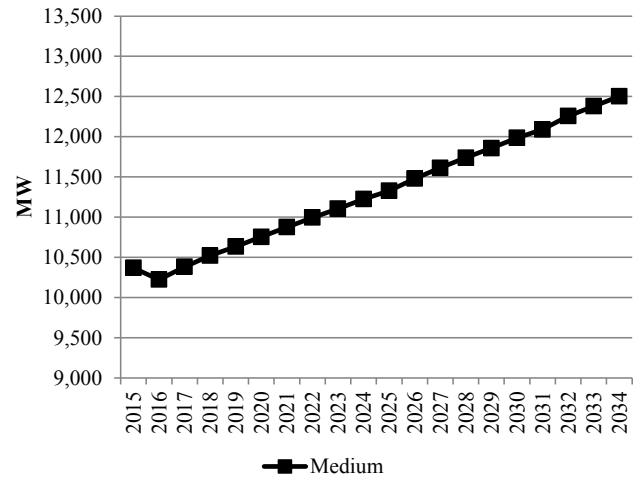

Energy Efficiency (Class 2 DSM)

This case uses base supply curves with economic resource selections up to the achievable potential. Class 2 resources that are not selected in any given year are not available for selection in future years. Achievable potential by state and year are summarized in the following figure.

Class 2 DSM Cumulative Achievable Potential

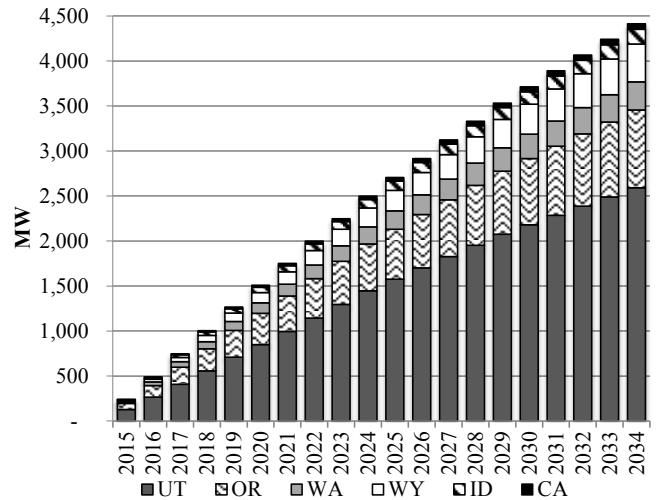

Case C14a-2

Distributed Generation

Base case distributed generation penetration is assumed in all states. Distributed generation by state and year are summarized in the following figure.

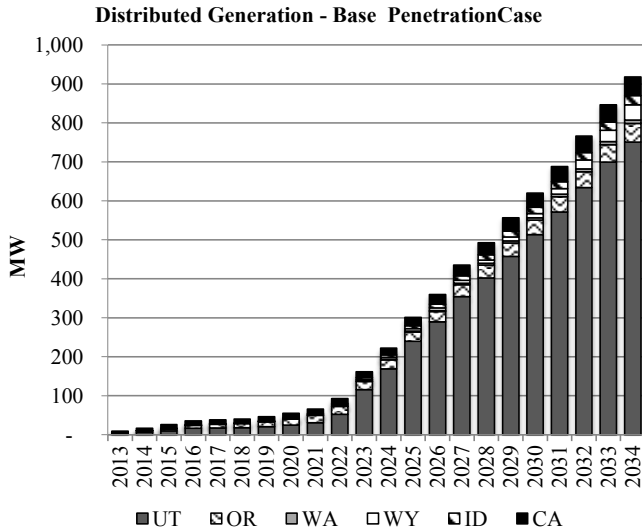

PORTFOLIO SUMMARY

System Optimizer PVRR (\$m)

System Cost without Transmission Upgrades	\$39,271
Transmission Integration	\$69
Transmission Reinforcement	\$7
Total Cost	\$39,347

Resource Portfolio

Cumulative changes to the resource portfolio (new resource additions and resource retirements), represented as nameplate capacity, are summarized in the figure below.

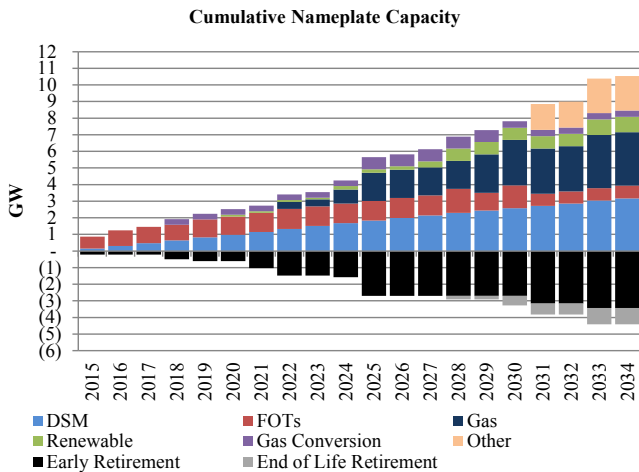

System CO₂ Emissions (System Optimizer)

System CO₂ emissions from System Optimizer are shown alongside those from Cases C01-R and C01-2 in the following figure.

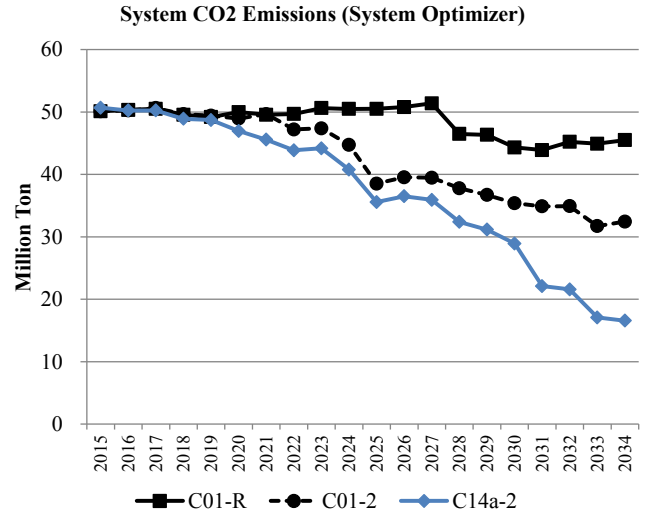

111(d) Compliance Profiles

The following figures summarize how compliance with state emission rate goals is achieved. The sum of each stacked bar represents the fossil emission rate. The net final rate represents the fossil rate after accounting for the emission rate impacts of new thermal (new NGCC units or nuclear, as applicable), re-dispatch of fossil units, energy efficiency (EE), and allocated renewable energy (RE).

PacifiCorp Share of WY Compliance Profile (lb/MWh)

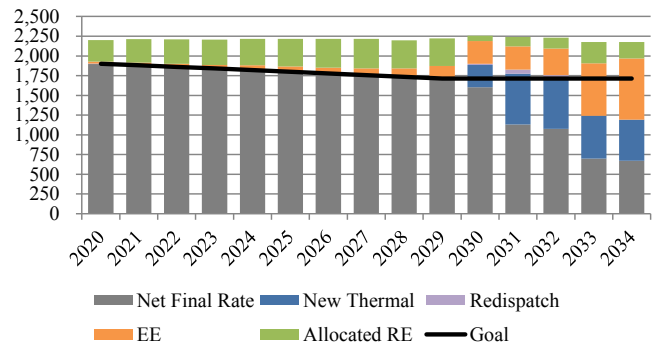

Case C14a-2

PacifiCorp Share of UT Compliance Profile (lb/MWh)

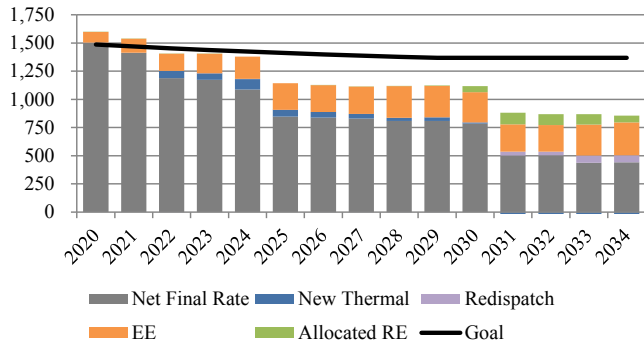

PacifiCorp Share of OR Compliance Profile (lb/MWh)

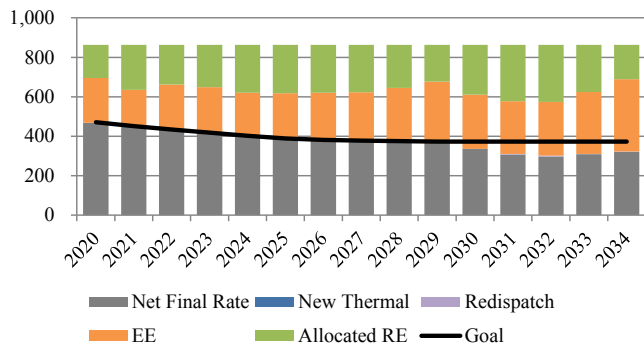

PacifiCorp Share of WA Compliance Profile (lb/MWh)

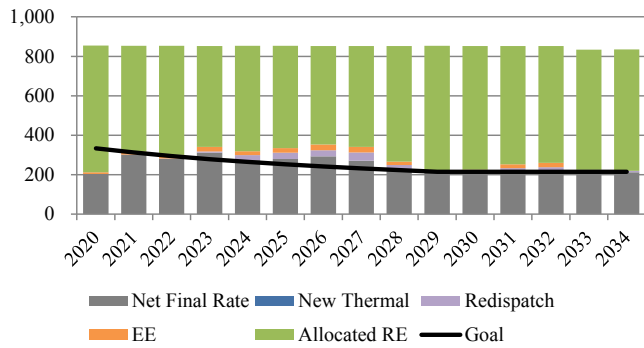

Sensitivity Case Fact Sheets

Sensitivity Case Fact Sheets S-01 – S-15

Sensitivity: S-01 (Low Load Forecast)

CASE ASSUMPTIONS

Description

Sensitivity S-01 assumes a low load forecast in producing a portfolio that meets PacifiCorp’s share of state 111(d) emission rate goals in all states in which PacifiCorp has fossil generation and retail customers. The compliance strategy applied to this case relies on flexible allocation of renewable energy and energy efficiency while prioritizing re-dispatch of fossil generation to achieve incremental emission rate reductions as required. For planning purposes, this case assumes Regional Haze Scenario 1 reflecting potential inter-temporal and fleet trade-off compliance outcomes. This sensitivity is a variant of Core Case C05-1.

Federal CO₂ Policy/Price Signal

Sensitivity S-01 reflects EPA’s proposed 111(d) rule with no additional CO₂ price signal. The table below summarizes the interim emission rate goal and the final emission rate target by state assumed to apply to PacifiCorp’s system.

State	Interim Goal (Avg. 2020-2029) (lb/MWh)	Final Target (2030 & Beyond) (lb/MWh)
WY	1,808	1,714
UT*	1,378	1,322
OR	407	372
WA	264	215

*EPA’s calculation of the target for UT treated PacifiCorp’s Lakeside 2 NGCC plant as an existing resource. The emission rate assumed for UT assumes Lake Side 2 is correctly classified as “under construction”.

The 111(d) compliance strategy implemented for this case is summarized as follows:

- Flexible allocation of system renewable resources and flexible allocation of cumulative energy efficiency savings beginning 2017 from ID and CA, where PacifiCorp does not own fossil generation.
- Cumulative cost-effective selection of energy efficiency beginning 2017.
- New NGCC generation in WY and UT (new NGCC resources are not allowed in OR, WA, and ID).
- Re-dispatch of existing fossil generation, as required.
- Addition of new renewable resources, as required.

Forward Price Curve

Sensitivity S-1 gas and power prices will utilize medium natural gas prices as well as market price impacts associated with EPA’s proposed 111(d) rules. These forecasts begin with the Company’s base September 30, 2014 official forward price curve.

Nominal Average Annual Henry Hub Gas Prices

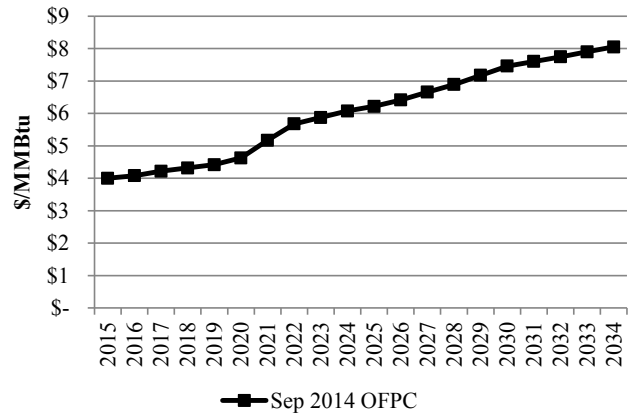

Nominal Average Annual Power Prices (Flat)

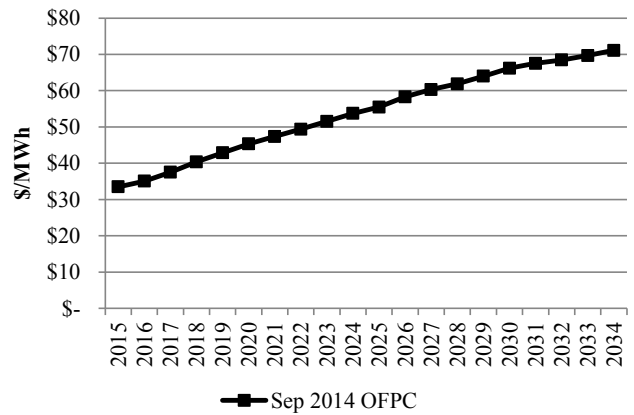

Regional Haze

Sensitivity S-1 reflects Regional Haze Scenario 1, which assumes inter-temporal and fleet trade-off Regional Haze compliance outcomes as shown in the table below. This scenario is for planning purposes recognizing that agency, regulator, and joint owner perspectives on acceptability have not been determined.

Coal Unit	Description
Carbon 1	Shut Down Apr 2015
Carbon 2	Shut Down Apr 2015
Cholla 4	Conversion by Jun 2025
Colstrip 3	SCR by Dec 2023
Colstrip 4	SCR by Dec 2022
Craig 1	SCR by Aug 2021
Craig 2	SCR by Jan 2018
Dave Johnston 1	Shut Down Mar 2019
Dave Johnston 2	Shut Down Dec 2027
Dave Johnston 3	Shut Down Dec 2027
Dave Johnston 4	Shut Down Dec 2032
Hayden 1	SCR by Jun 2015
Hayden 2	SCR by Jun 2016
Hunter 1	SCR by Dec 2021
Hunter 2	Shut Down by Dec 2032
Hunter 3	SCR by Dec 2024
Huntington 1	Shut Down by Dec 2036

Sensitivity: S-01 (Low Load Forecast)

Coal Unit	Description
Huntington 2	Shut Down by Dec 2021
Jim Bridger 1	Shut Down by Dec 2023
Jim Bridger 2	Shut Down by Dec 2032
Jim Bridger 3	SCR by Dec 2015
Jim Bridger 4	SCR by Dec 2016
Naughton 1	Shut Down by Dec 2029
Naughton 2	Shut Down by Dec 2029
Naughton 3	Conversion by Jun 2018; Shut Down by Dec 2029
Wyodak	Shut Down by Dec 2039

*SCR = selective catalytic reduction

Federal Tax Incentives

- PTCs expire end of 2013
- ITC of 30% expire end of 2016, thereafter it continues in perpetuity at 10%.

Load Forecast

A low load forecast derived using low economic driver assumptions will be used. The figure below shows the change in system coincident peak as compared to the medium (base) load forecast before accounting for any potential contribution from DSM or distributed generation resources.

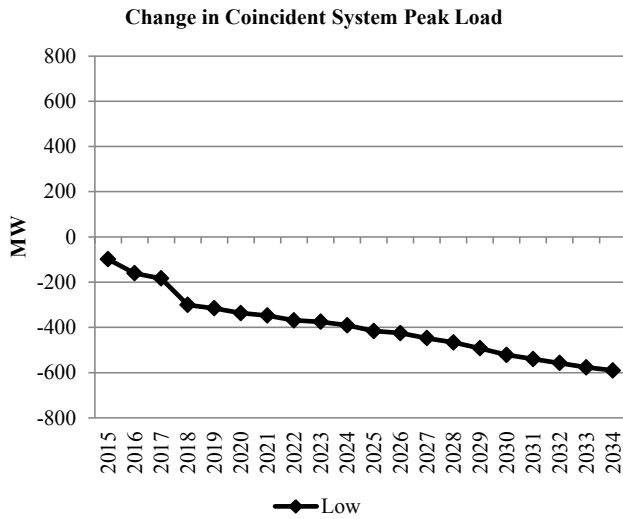

Energy Efficiency (Class 2 DSM)

Base case supply curves and ramp rates with resource selections up to the achievable potential. Class 2 resources that are not selected in any given year are not available for selection in future years. Achievable potential by state and year are summarized below.

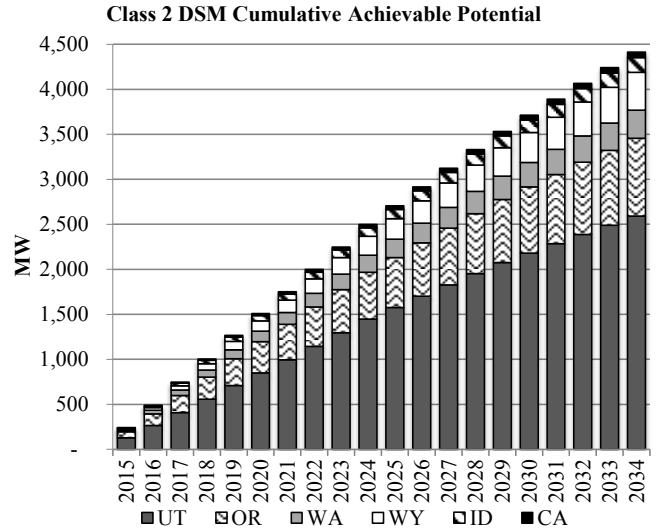

Distributed Generation

Base case distributed generation penetration is assumed in all states. Distributed generation by state and year are summarized below.

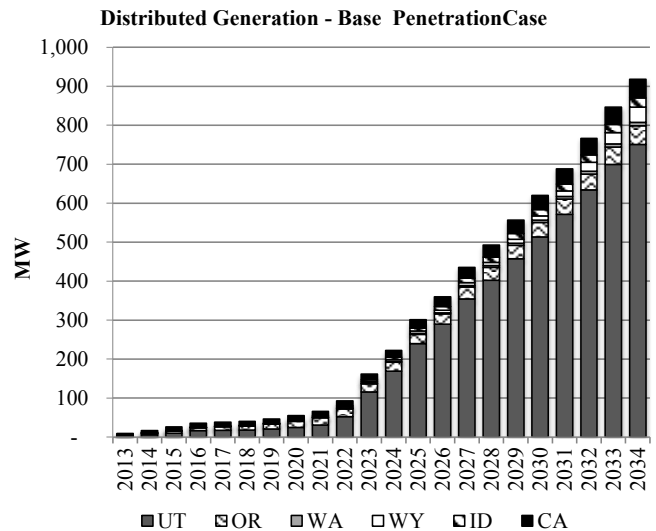

PORTFOLIO SUMMARY

System Optimizer PVRR (\$m)

System Cost without Transmission Upgrades	\$24,680
Transmission Integration	\$28
Transmission Reinforcement	\$6
Total Cost	\$24,715

Sensitivity: S-01 (Low Load Forecast)

Resource Portfolio

Cumulative changes to the resource portfolio (new resource additions and resource retirements), represented as nameplate capacity, are summarized in the figure below.

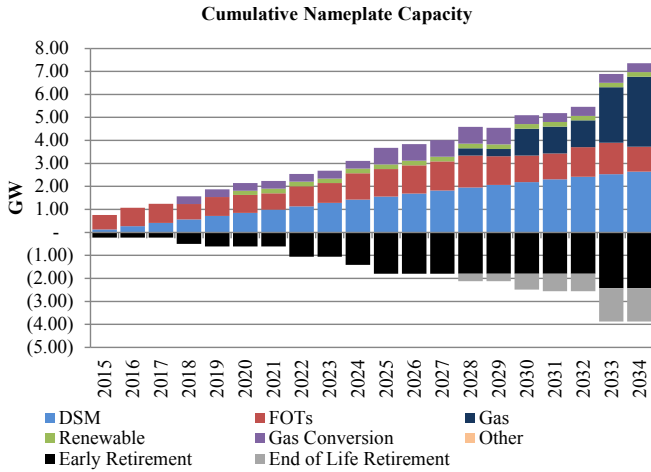

System CO₂ Emissions (System Optimizer)

System CO₂ emissions from System Optimizer are shown alongside those from Cases C05-1 and S-01 in the figure below.

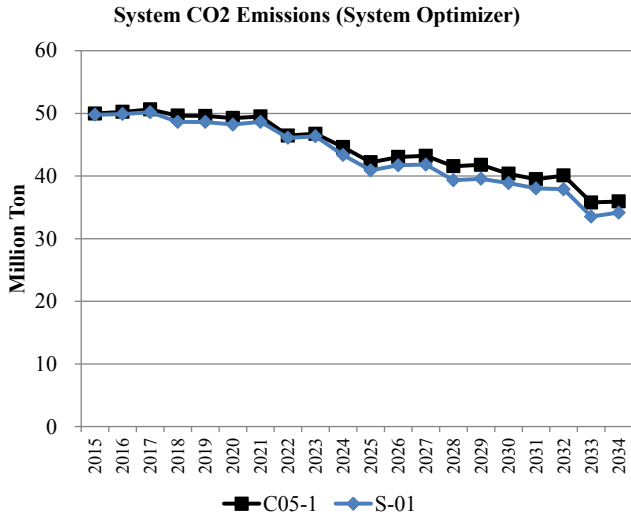

111(d) Compliance Profiles

The following figures summarize how compliance with state emission rate goals is achieved. The sum of each stacked bar represents the fossil emission rate. The net final rate represents the fossil rate after accounting for the emission rate impacts of new thermal (new NGCC units or nuclear, as applicable), re-dispatch of fossil units, energy efficiency (EE), and allocated renewable energy (RE).

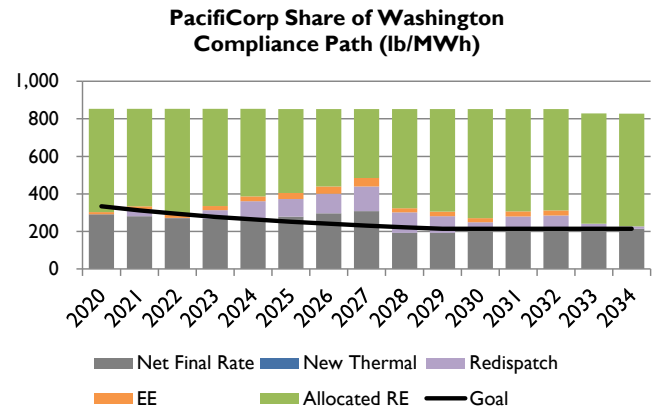
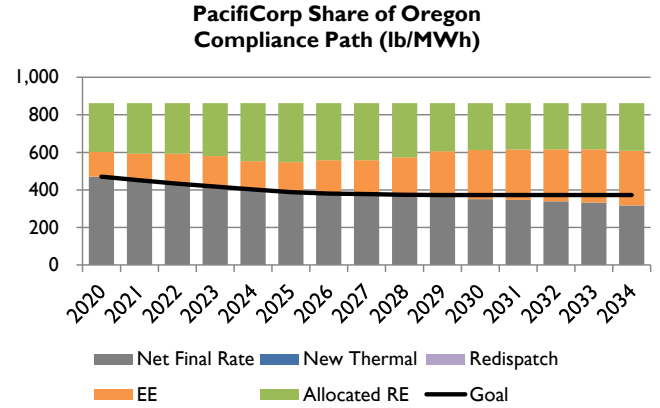
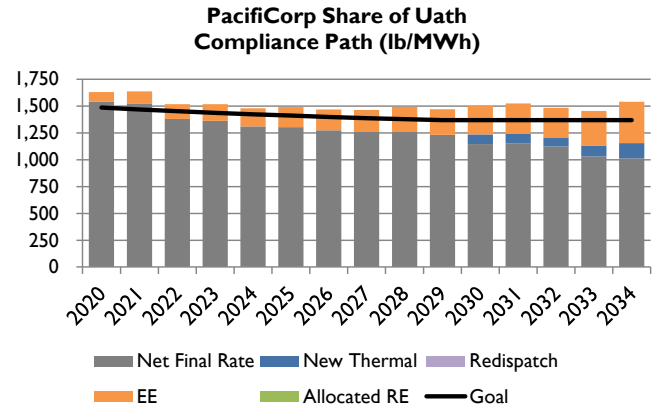
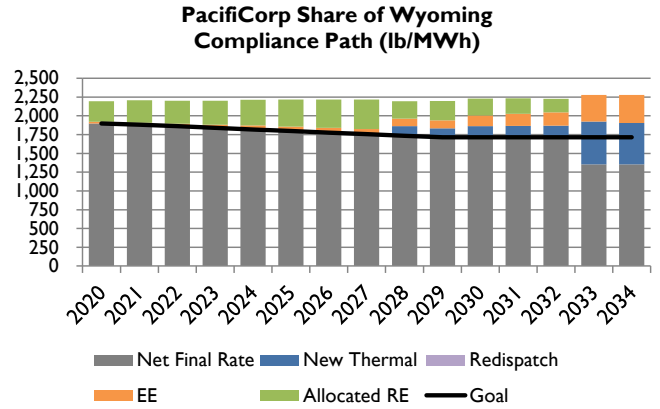

Sensitivity: S-02 (High Load Forecast)

CASE ASSUMPTIONS

Description

Sensitivity S-02 assumes a high load forecast in producing a portfolio that meets PacifiCorp's share of state 111(d) emission rate goals in all states in which PacifiCorp has fossil generation and retail customers. The compliance strategy applied to this case relies on flexible allocation of renewable energy and energy efficiency while prioritizing re-dispatch of fossil generation to achieve incremental emission rate reductions as required. For planning purposes, this case assumes Regional Haze Scenario 1 reflecting potential inter-temporal and fleet trade-off compliance outcomes. This sensitivity is a variant of Core Case C05-1.

Federal CO₂ Policy/Price Signal

Sensitivity S-02 reflects EPA's proposed 111(d) rule with no additional CO₂ price signal. The table below summarizes the interim emission rate goal and the final emission rate target by state assumed to apply to PacifiCorp's system.

State	Interim Goal (Avg. 2020-2029) (lb/MWh)	Final Target (2030 & Beyond) (lb/MWh)
WY	1,808	1,714
UT*	1,378	1,322
OR	407	372
WA	264	215

*EPA's calculation of the target for UT treated PacifiCorp's Lakeside 2 NGCC plant as an existing resource. The emission rate assumed for UT assumes Lake Side 2 is correctly classified as "under construction".

The 111(d) compliance strategy implemented for this case is summarized as follows:

- Flexible allocation of system renewable resources and flexible allocation of cumulative energy efficiency savings beginning 2017 from ID and CA, where PacifiCorp does not own fossil generation.
- Cumulative cost-effective selection of energy efficiency beginning 2017.
- New NGCC generation in WY and UT (new NGCC resources are not allowed in OR, WA, and ID).
- Re-dispatch of existing fossil generation, as required.
- Addition of new renewable resources, as required.

Forward Price Curve

Sensitivity S-2 gas and power prices will utilize medium natural gas prices as well as market price impacts associated with EPA's proposed 111(d) rules. These forecasts begin with the Company's base September 30, 2014 official forward price curve.

Nominal Average Annual Henry Hub Gas Prices

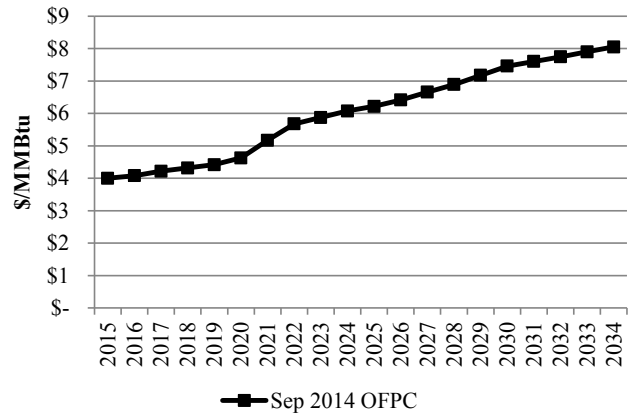

Nominal Average Annual Power Prices (Flat)

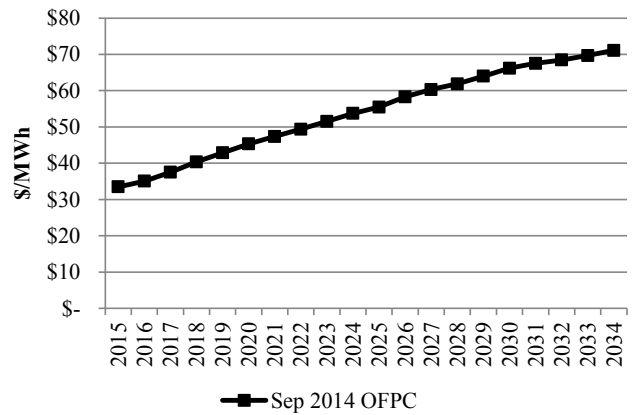

Regional Haze

Sensitivity S-2 reflects Regional Haze Scenario 1, which assumes inter-temporal and fleet trade-off Regional Haze compliance outcomes as shown in the table below. This scenario is for planning purposes recognizing that agency, regulator, and joint owner perspectives on acceptability have not been determined.

Coal Unit	Description
Carbon 1	Shut Down Apr 2015
Carbon 2	Shut Down Apr 2015
Cholla 4	Conversion by Jun 2025
Colstrip 3	SCR by Dec 2023
Colstrip 4	SCR by Dec 2022
Craig 1	SCR by Aug 2021
Craig 2	SCR by Jan 2018
Dave Johnston 1	Shut Down Mar 2019
Dave Johnston 2	Shut Down Dec 2027
Dave Johnston 3	Shut Down Dec 2027
Dave Johnston 4	Shut Down Dec 2032
Hayden 1	SCR by Jun 2015
Hayden 2	SCR by Jun 2016
Hunter 1	SCR by Dec 2021
Hunter 2	Shut Down by Dec 2032
Hunter 3	SCR by Dec 2024
Huntington 1	Shut Down by Dec 2036

Sensitivity: S-02 (High Load Forecast)

Huntington 2	Shut Down by Dec 2021
Jim Bridger 1	Shut Down by Dec 2023
Jim Bridger 2	Shut Down by Dec 2032
Jim Bridger 3	SCR by Dec 2015
Jim Bridger 4	SCR by Dec 2016
Naughton 1	Shut Down by Dec 2029
Naughton 2	Shut Down by Dec 2029
Naughton 3	Conversion by Jun 2018; Shut Down by Dec 2029
Wyodak	Shut Down by Dec 2039

SCR = selective catalytic reduction

Federal Tax Incentives

- PTCs expire end of 2013
- ITC of 30% expire end of 2016, thereafter it continues in perpetuity at 10%.

Load Forecast

A high load forecast derived using high economic drivers and high industrial load growth will be used. The figure below shows the change in system coincident peak as compared to the medium (base) load forecast before accounting for any potential contribution from DSM or distributed generation resources.

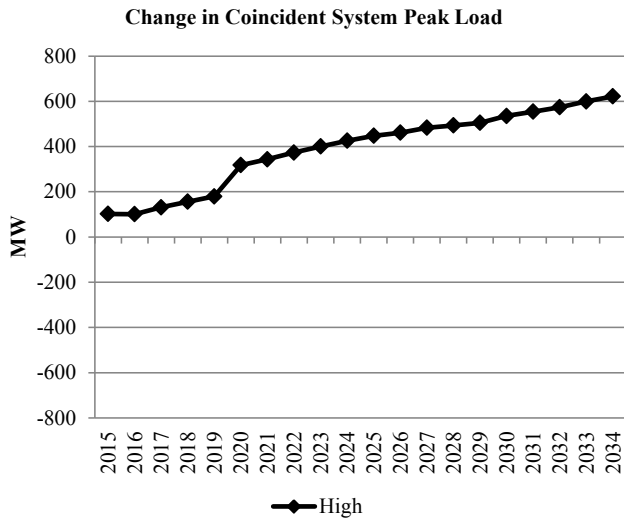

Energy Efficiency (Class 2 DSM)

Base case supply curves and ramp rates with resource selections up to the achievable potential. Class 2 resources that are not selected in any given year are not available for selection in future years. Achievable potential by state and year are summarized below.

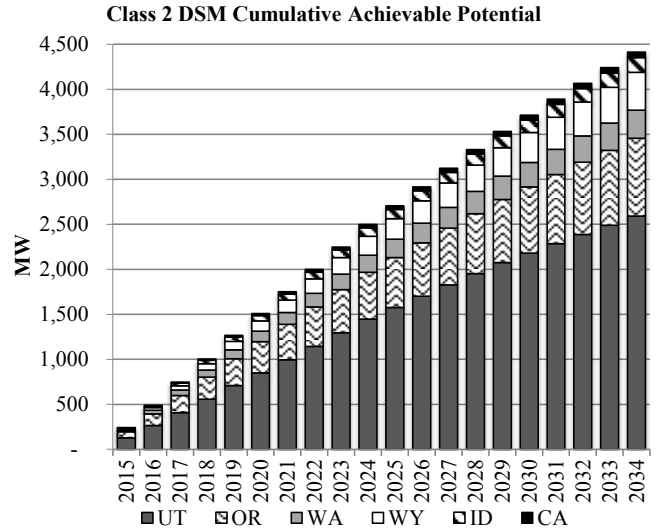

Distributed Generation

Base case distributed generation penetration is assumed in all states. Distributed generation by state and year are summarized below.

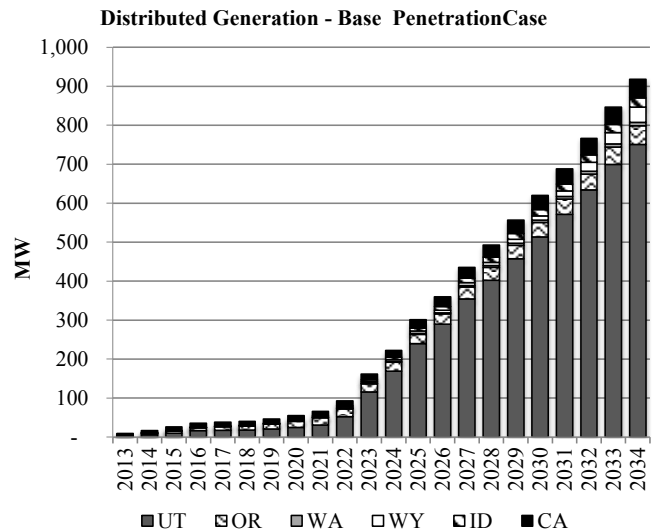

PORTFOLIO SUMMARY

System Optimizer PVRR (\$m)

System Cost without Transmission Upgrades	\$28,269
Transmission Integration	\$59
Transmission Reinforcement	\$6
Total Cost	\$28,334

Sensitivity: S-02 (High Load Forecast)

Resource Portfolio

Cumulative changes to the resource portfolio (new resource additions and resource retirements), represented as nameplate capacity, are summarized in the figure below.

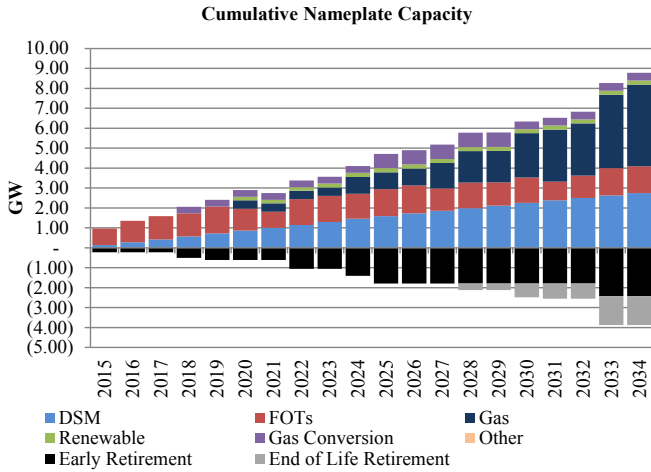

System CO₂ Emissions (System Optimizer)

System CO₂ emissions from System Optimizer are shown alongside those from Cases C05-1 and S-02 in the figure below.

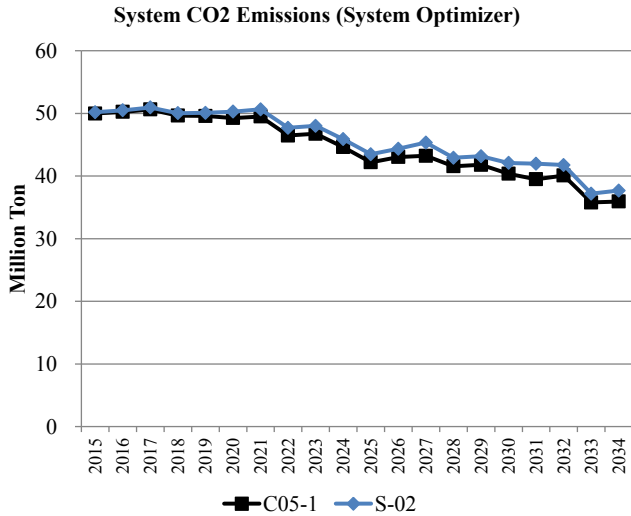

111(d) Compliance Profiles

The following figures summarize how compliance with state emission rate goals is achieved. The sum of each stacked bar represents the fossil emission rate. The net final rate represents the fossil rate after accounting for the emission rate impacts of new thermal (new NGCC units or nuclear, as applicable), re-dispatch of fossil units, energy efficiency (EE), and allocated renewable energy (RE).

PacifiCorp Share of Wyoming Compliance Path (lb/MWh)

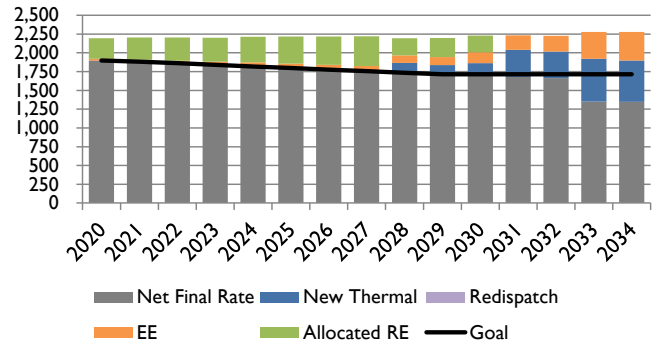

PacifiCorp Share of Utah Compliance Path (lb/MWh)

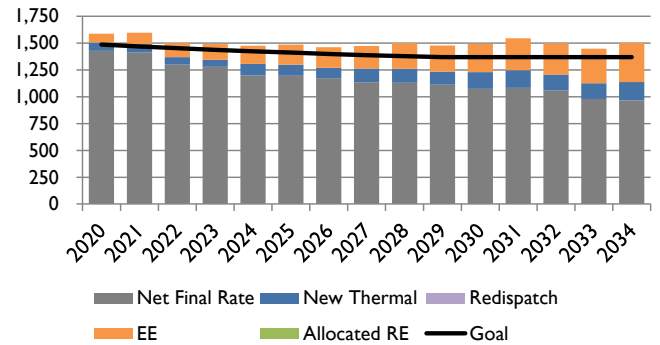

PacifiCorp Share of Oregon Compliance Path (lb/MWh)

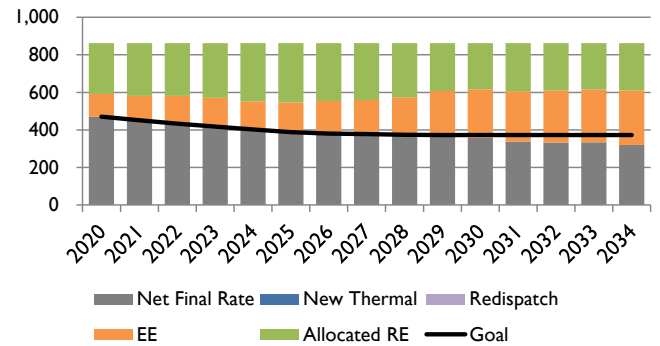

PacifiCorp Share of Washington Compliance Path (lb/MWh)

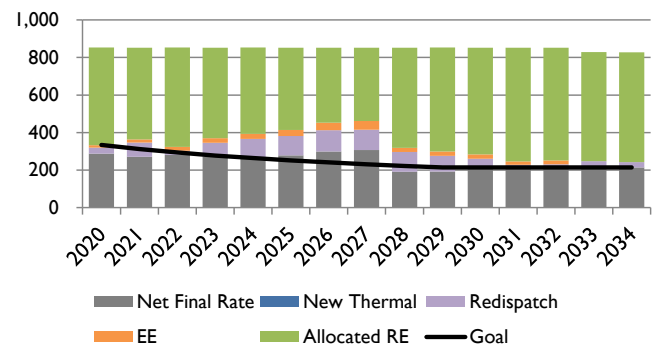

Sensitivity: S-03 (1 in 20 Load Forecast)

CASE ASSUMPTIONS

Description

Sensitivity S-03 assumes a 1-in-20 peak load forecast in producing a portfolio that meets PacifiCorp’s share of state 111(d) emission rate goals in all states in which PacifiCorp has fossil generation and retail customers. The compliance strategy applied to this case relies on flexible allocation of renewable energy and energy efficiency while prioritizing re-dispatch of fossil generation to achieve incremental emission rate reductions as required. For planning purposes, this case assumes Regional Haze Scenario 1 reflecting potential inter-temporal and fleet trade-off compliance outcomes. This sensitivity is a variant of Core Case C05-1.

Federal CO₂ Policy/Price Signal

Sensitivity S-03 reflects EPA’s proposed 111(d) rule with no additional CO₂ price signal. The table below summarizes the interim emission rate goal and the final emission rate target by state assumed to apply to PacifiCorp’s system.

State	Interim Goal (Avg. 2020-2029) (lb/MWh)	Final Target (2030 & Beyond) (lb/MWh)
WY	1,808	1,714
UT*	1,378	1,322
OR	407	372
WA	264	215

*EPA’s calculation of the target for UT treated PacifiCorp’s Lakeside 2 NGCC plant as an existing resource. The emission rate assumed for UT assumes Lake Side 2 is correctly classified as “under construction”.

The 111(d) compliance strategy implemented for this case is summarized as follows:

- Flexible allocation of system renewable resources and flexible allocation of cumulative energy efficiency savings beginning 2017 from ID and CA, where PacifiCorp does not own fossil generation.
- Cumulative cost-effective selection of energy efficiency beginning 2017.
- New NGCC generation in WY and UT (new NGCC resources are not allowed in OR, WA, and ID).
- Re-dispatch of existing fossil generation, as required.
- Addition of new renewable resources, as required.

Forward Price Curve

Sensitivity S-3 gas and power prices will utilize medium natural gas prices as well as market price impacts associated with EPA’s proposed 111(d) rules. These forecasts begin with the Company’s base September 30, 2014 official forward price

curve.

Nominal Average Annual Henry Hub Gas Prices

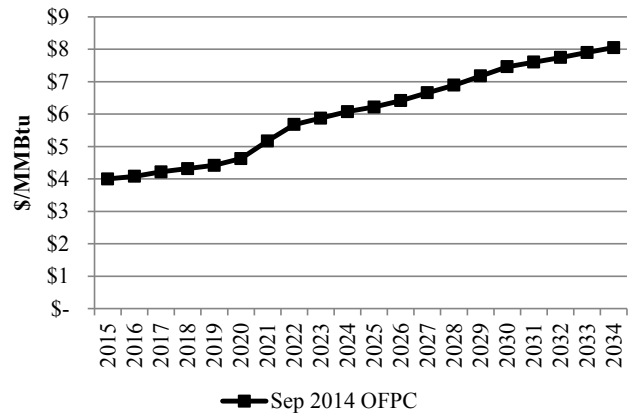

Nominal Average Annual Power Prices (Flat)

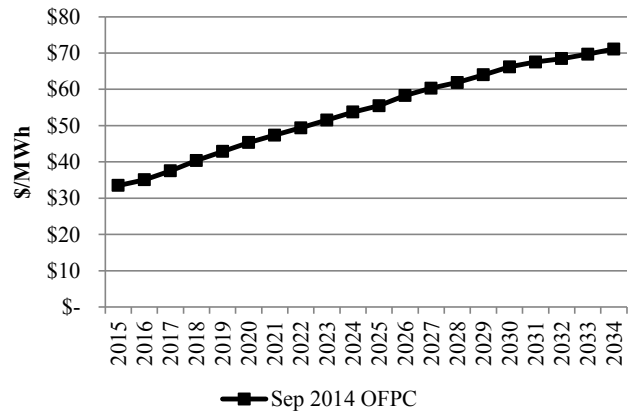

Regional Haze

Sensitivity S-3 reflects Regional Haze Scenario 1, which assumes inter-temporal and fleet trade-off Regional Haze compliance outcomes as shown in the table below. This scenario is for planning purposes recognizing that agency, regulator, and joint owner perspectives on acceptability have not been determined.

Coal Unit	Description
Carbon 1	Shut Down Apr 2015
Carbon 2	Shut Down Apr 2015
Cholla 4	Conversion by Jun 2025
Colstrip 3	SCR by Dec 2023
Colstrip 4	SCR by Dec 2022
Craig 1	SCR by Aug 2021
Craig 2	SCR by Jan 2018
Dave Johnston 1	Shut Down Mar 2019
Dave Johnston 2	Shut Down Dec 2027
Dave Johnston 3	Shut Down Dec 2027
Dave Johnston 4	Shut Down Dec 2032
Hayden 1	SCR by Jun 2015
Hayden 2	SCR by Jun 2016
Hunter 1	SCR by Dec 2021
Hunter 2	Shut Down by Dec 2032
Hunter 3	SCR by Dec 2024

Sensitivity: S-03 (1 in 20 Load Forecast)

Huntington 1	Shut Down by Dec 2036
Huntington 2	Shut Down by Dec 2021
Jim Bridger 1	Shut Down by Dec 2023
Jim Bridger 2	Shut Down by Dec 2032
Jim Bridger 3	SCR by Dec 2015
Jim Bridger 4	SCR by Dec 2016
Naughton 1	Shut Down by Dec 2029
Naughton 2	Shut Down by Dec 2029
Naughton 3	Conversion by Jun 2018; Shut Down by Dec 2029
Wyodak	Shut Down by Dec 2039

SCR = selective catalytic reduction

Federal Tax Incentives

- PTCs expire end of 2013
- ITC of 30% expire end of 2016, thereafter it continues in perpetuity at 10%.

Load Forecast

A 1 in 20 load forecast reflecting the top peak producing weather over the past 20 years will be used. The figure below shows the change in system coincident peak as compared to the medium (base) load forecast before accounting for any potential contribution from DSM or distributed generation resources.

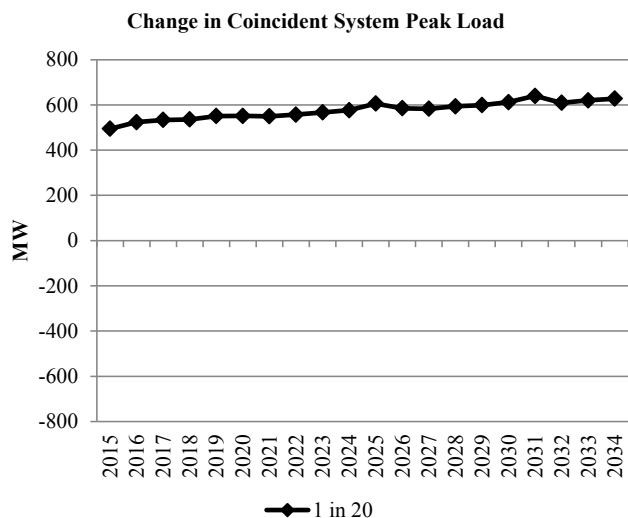

Energy Efficiency (Class 2 DSM)

Base case supply curves and ramp rates with resource selections up to the achievable potential. Class 2 resources that are not selected in any given year are not available for selection in future years. Achievable potential by state and year are summarized below.

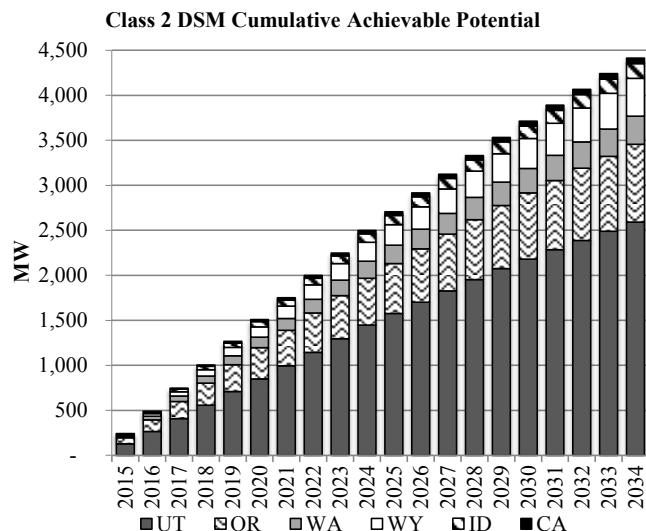

Distributed Generation

Base case distributed generation penetration is assumed in all states. Distributed generation by state and year are summarized below.

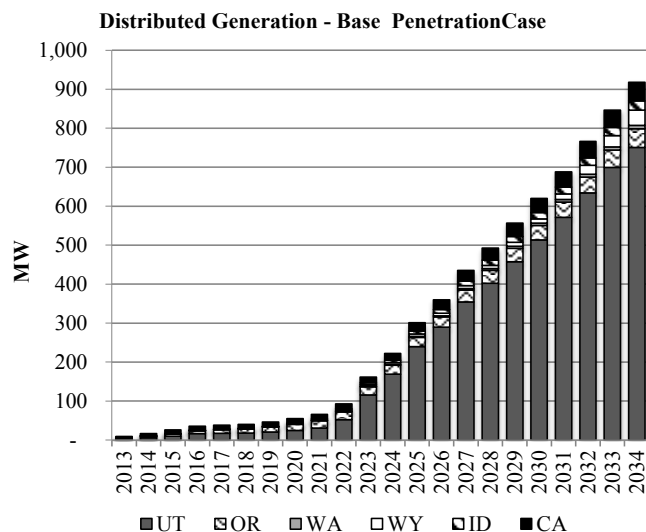

PORTFOLIO SUMMARY

System Optimizer PVRR (\$m)

System Cost without Transmission Upgrades	\$27,529
Transmission Integration	\$175
Transmission Reinforcement	\$6
Total Cost	\$27,709

Sensitivity: S-03 (1 in 20 Load Forecast)

Resource Portfolio

Cumulative changes to the resource portfolio (new resource additions and resource retirements), represented as nameplate capacity, are summarized in the figure below.

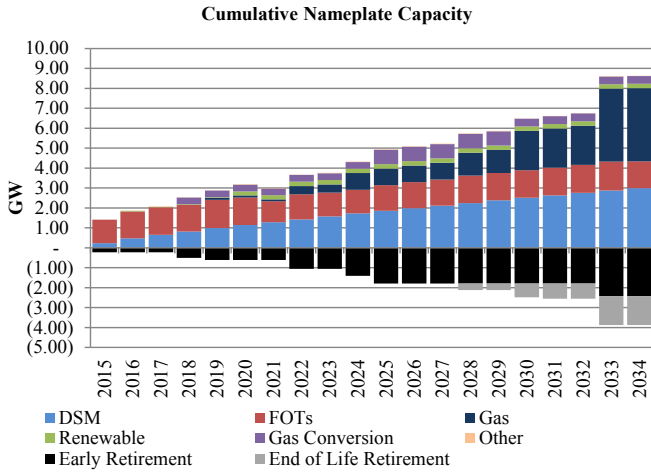

System CO₂ Emissions (System Optimizer)

System CO₂ emissions from System Optimizer are shown alongside those from Cases C05-1 and S-03 in the figure below.

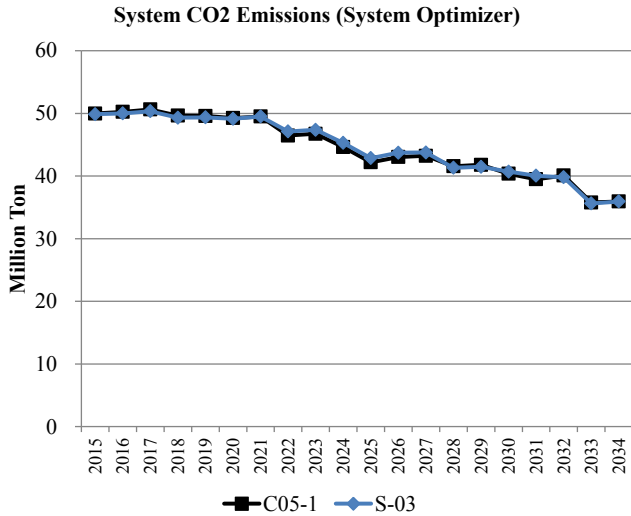

111(d) Compliance Profiles

The following figures summarize how compliance with state emission rate goals is achieved. The sum of each stacked bar represents the fossil emission rate. The net final rate represents the fossil rate after accounting for the emission rate impacts of new thermal (new NGCC units or nuclear, as applicable), re-dispatch of fossil units, energy efficiency (EE), and allocated renewable energy (RE).

PacifiCorp Share of Wyoming Compliance Path (lb/MWh)

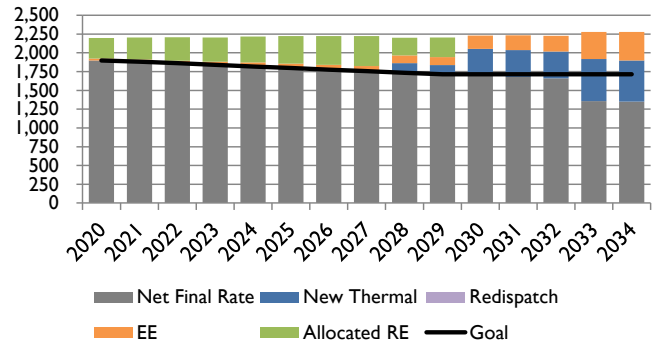

PacifiCorp Share of Wyoming Compliance Path (lb/MWh)

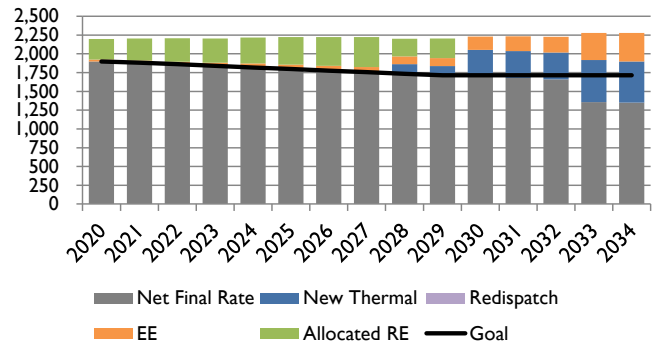

PacifiCorp Share of Oregon Compliance Path (lb/MWh)

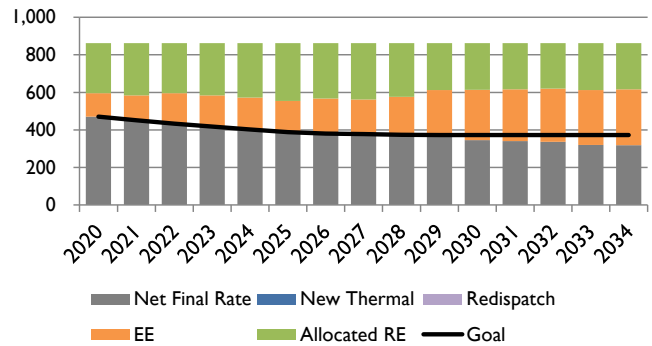

PacifiCorp Share of Washington Compliance Path (lb/MWh)

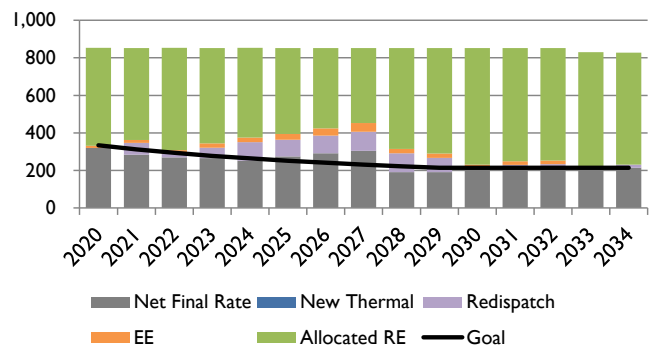

Sensitivity: S-04 (Low Distributed Generation Forecast)

CASE ASSUMPTIONS

Description

Sensitivity S-04 assumes a low penetration of distributed generation (DG) in producing a portfolio that meets PacifiCorp's share of state 111(d) emission rate goals in all states in which PacifiCorp has fossil generation and retail customers. The compliance strategy applied to this case relies on flexible allocation of renewable energy and energy efficiency while prioritizing re-dispatch of fossil generation to achieve incremental emission rate reductions as required. For planning purposes, this case assumes Regional Haze Scenario 1 reflecting potential inter-temporal and fleet trade-off compliance outcomes. This sensitivity is a variant of Core Case C05-1.

Federal CO₂ Policy/Price Signal

Sensitivity S-04 reflects EPA's proposed 111(d) rule with no additional CO₂ price signal. The table below summarizes the interim emission rate goal and the final emission rate target by state assumed to apply to PacifiCorp's system.

State	Interim Goal (Avg. 2020-2029) (lb/MWh)	Final Target (2030 & Beyond) (lb/MWh)
WY	1,808	1,714
UT*	1,378	1,322
OR	407	372
WA	264	215

*EPA's calculation of the target for UT treated PacifiCorp's Lakeside 2 NGCC plant as an existing resource. The emission rate assumed for UT assumes Lake Side 2 is correctly classified as "under construction".

The 111(d) compliance strategy implemented for this case is summarized as follows:

- Flexible allocation of system renewable resources and flexible allocation of cumulative energy efficiency savings beginning 2017 from ID and CA, where PacifiCorp does not own fossil generation.
- Cumulative cost-effective selection of energy efficiency beginning 2017.
- New NGCC generation in WY and UT (new NGCC resources are not allowed in OR, WA, and ID).
- Re-dispatch of existing fossil generation, as required.
- Addition of new renewable resources, as required.

Forward Price Curve

Sensitivity S-4 gas and power prices will utilize medium natural gas prices as well as market price impacts associated with EPA's proposed 111(d) rules. These forecasts begin with the Company's base September 30, 2014 official forward price curve.

Nominal Average Annual Henry Hub Gas Prices

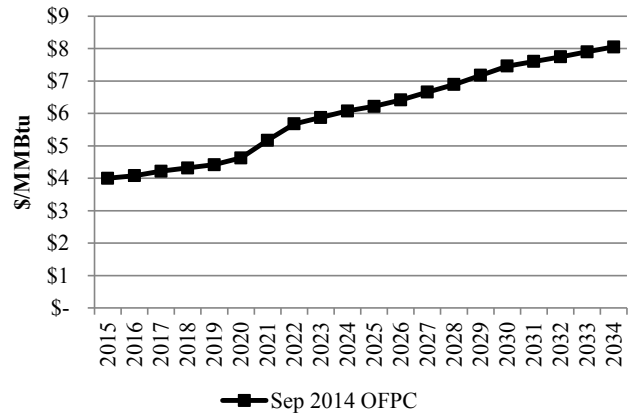

Nominal Average Annual Power Prices (Flat)

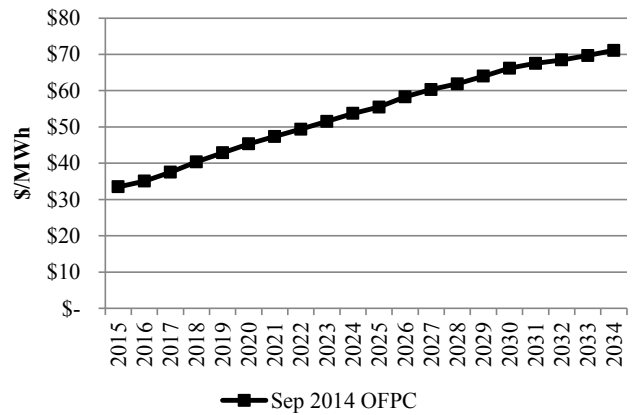

Regional Haze

Sensitivity S-4 reflects Regional Haze Scenario 1, which assumes inter-temporal and fleet trade-off Regional Haze compliance outcomes as shown in the table below. This scenario is for planning purposes recognizing that agency, regulator, and joint owner perspectives on acceptability have not been determined.

Coal Unit	Description
Carbon 1	Shut Down Apr 2015
Carbon 2	Shut Down Apr 2015
Cholla 4	Conversion by Jun 2025
Colstrip 3	SCR by Dec 2023
Colstrip 4	SCR by Dec 2022
Craig 1	SCR by Aug 2021
Craig 2	SCR by Jan 2018
Dave Johnston 1	Shut Down Mar 2019
Dave Johnston 2	Shut Down Dec 2027
Dave Johnston 3	Shut Down Dec 2027
Dave Johnston 4	Shut Down Dec 2032
Hayden 1	SCR by Jun 2015
Hayden 2	SCR by Jun 2016
Hunter 1	SCR by Dec 2021
Hunter 2	Shut Down by Dec 2032
Hunter 3	SCR by Dec 2024
Huntington 1	Shut Down by Dec 2036

Sensitivity: S-04 (Low Distributed Generation Forecast)

Huntington 2	Shut Down by Dec 2021
Jim Bridger 1	Shut Down by Dec 2023
Jim Bridger 2	Shut Down by Dec 2032
Jim Bridger 3	SCR by Dec 2015
Jim Bridger 4	SCR by Dec 2016
Naughton 1	Shut Down by Dec 2029
Naughton 2	Shut Down by Dec 2029
Naughton 3	Conversion by Jun 2018; Shut Down by Dec 2029
Wyodak	Shut Down by Dec 2039

SCR = selective catalytic reduction

Federal Tax Incentives

- PTCs expire end of 2013
- ITC of 30% expire end of 2016, thereafter it continues in perpetuity at 10%.

Load Forecast

The medium load forecast will be used. The figure below shows the system coincident peak load forecast before accounting for any potential contribution from DSM or distributed generation resources.

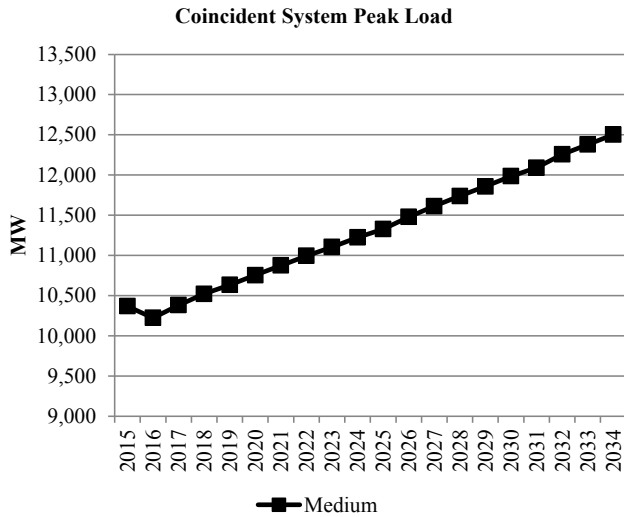

Energy Efficiency (Class 2 DSM)

Base case supply curves and ramp rates with resource selections up to the achievable potential. Class 2 resources that are not selected in any given year are not available for selection in future years. Achievable potential by state and year are summarized below.

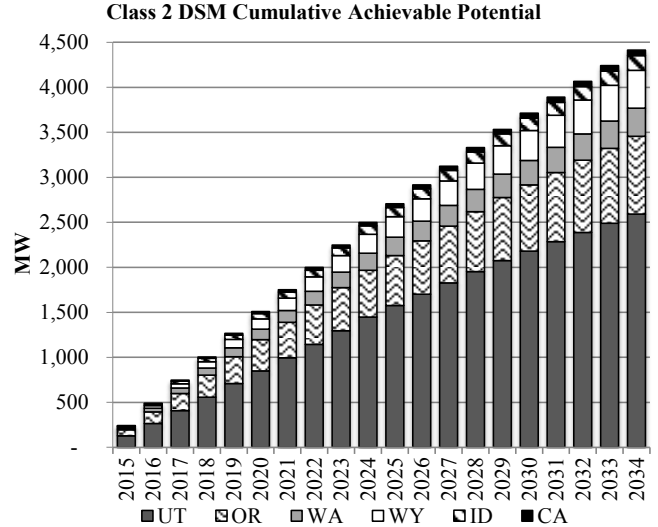

Distributed Generation

Low distributed generation penetration is assumed in all states. Distributed generation by state and year are summarized below.

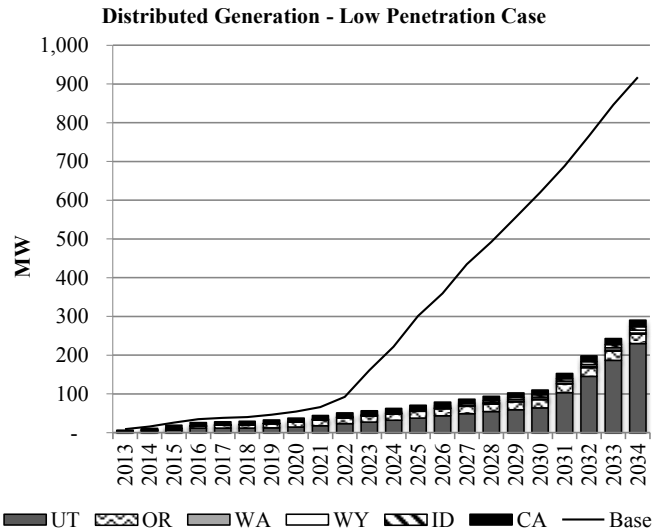

PORTFOLIO SUMMARY

System Optimizer PVRR (\$m)

System Cost without Transmission Upgrades	\$26,843
Transmission Integration	\$36
Transmission Reinforcement	\$6
Total Cost	\$26,885

Sensitivity: S-04 (Low Distributed Generation Forecast)

Resource Portfolio

Cumulative changes to the resource portfolio (new resource additions and resource retirements), represented as nameplate capacity, are summarized in the figure below.

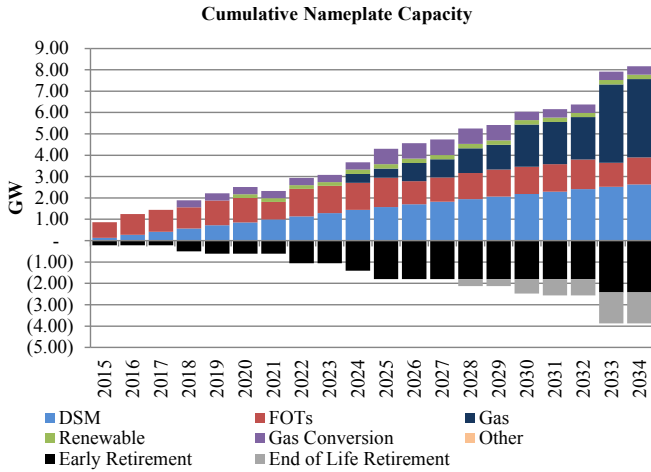

System CO₂ Emissions (System Optimizer)

System CO₂ emissions from System Optimizer are shown alongside those from Cases C05-1 and S-04 in the figure below.

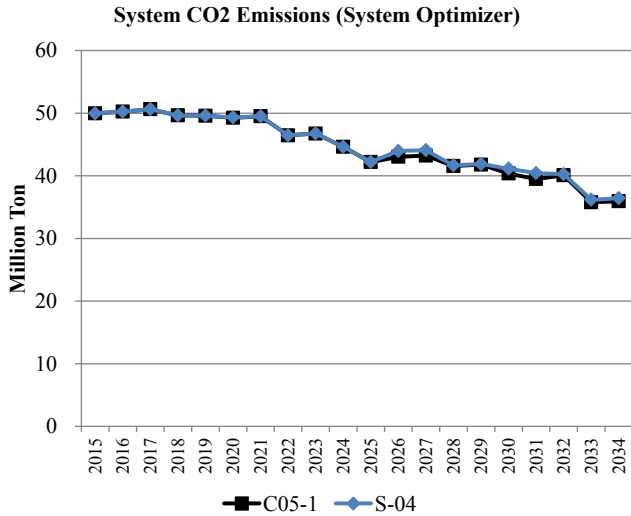

111(d) Compliance Profiles

The following figures summarize how compliance with state emission rate goals is achieved. The sum of each stacked bar represents the fossil emission rate. The net final rate represents the fossil rate after accounting for the emission rate impacts of new thermal (new NGCC units or nuclear, as applicable), re-dispatch of fossil units, energy efficiency (EE), and allocated renewable energy (RE).

PacifiCorp Share of Wyoming Compliance Path (lb/MWh)

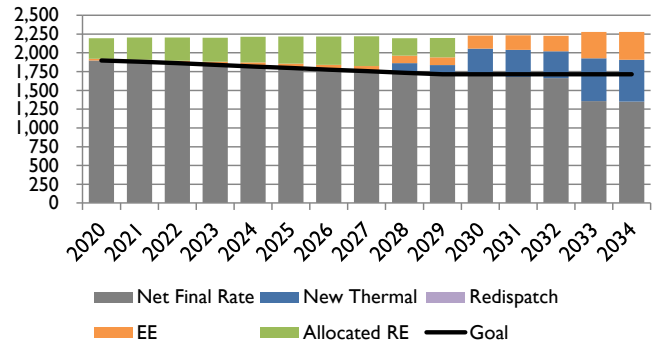

PacifiCorp Share of Utah Compliance Path (lb/MWh)

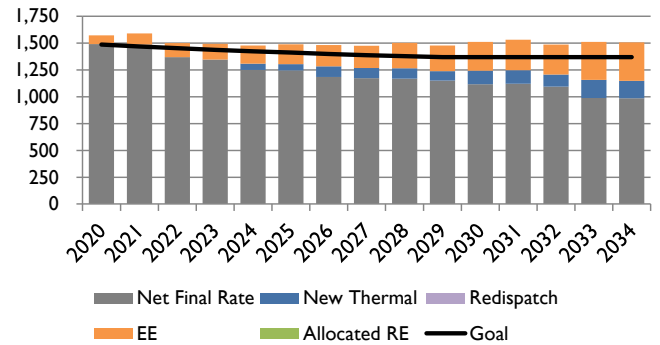

PacifiCorp Share of Oregon Compliance Path (lb/MWh)

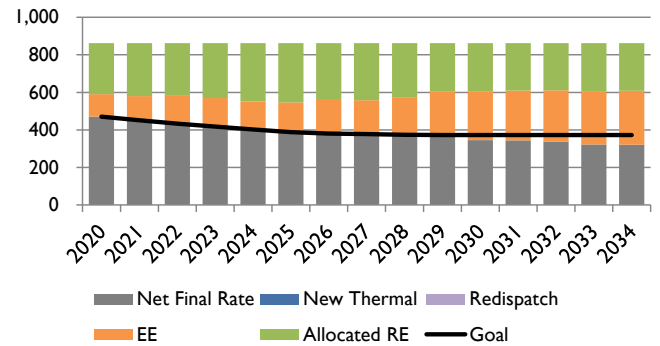

PacifiCorp Share of Washington Compliance Path (lb/MWh)

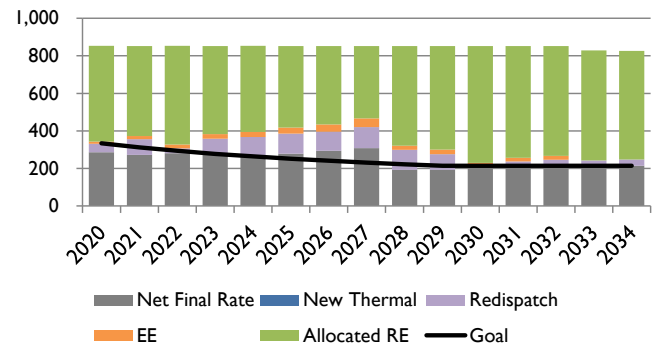

Sensitivity: S-05 (High Distributed Generation Forecast)

CASE ASSUMPTIONS

Description

Sensitivity S-05 assumes a high penetration of distributed generation (DG) in producing a portfolio that meets PacifiCorp's share of state 111(d) emission rate goals in all states in which PacifiCorp has fossil generation and retail customers. The compliance strategy applied to this case relies on flexible allocation of renewable energy and energy efficiency while prioritizing re-dispatch of fossil generation to achieve incremental emission rate reductions as required. For planning purposes, this case assumes Regional Haze Scenario 1 reflecting potential inter-temporal and fleet trade-off compliance outcomes. This sensitivity is a variant of Core Case C05-1.

Federal CO₂ Policy/Price Signal

Sensitivity S-05 reflects EPA's proposed 111(d) rule with no additional CO₂ price signal. The table below summarizes the interim emission rate goal and the final emission rate target by state assumed to apply to PacifiCorp's system.

State	Interim Goal (Avg. 2020-2029) (lb/MWh)	Final Target (2030 & Beyond) (lb/MWh)
WY	1,808	1,714
UT*	1,378	1,322
OR	407	372
WA	264	215

*EPA's calculation of the target for UT treated PacifiCorp's Lakeside 2 NGCC plant as an existing resource. The emission rate assumed for UT assumes Lake Side 2 is correctly classified as "under construction".

The 111(d) compliance strategy implemented for this case is summarized as follows:

- Flexible allocation of system renewable resources and flexible allocation of cumulative energy efficiency savings beginning 2017 from ID and CA, where PacifiCorp does not own fossil generation.
- Cumulative cost-effective selection of energy efficiency beginning 2017.
- New NGCC generation in WY and UT (new NGCC resources are not allowed in OR, WA, and ID).
- Re-dispatch of existing fossil generation, as required.
- Addition of new renewable resources, as required.

Forward Price Curve

Sensitivity S-5 gas and power prices will utilize medium natural gas prices as well as market price impacts associated with EPA's proposed 111(d) rules. These forecasts begin with the Company's base September 30, 2014 official forward price curve.

Nominal Average Annual Henry Hub Gas Prices

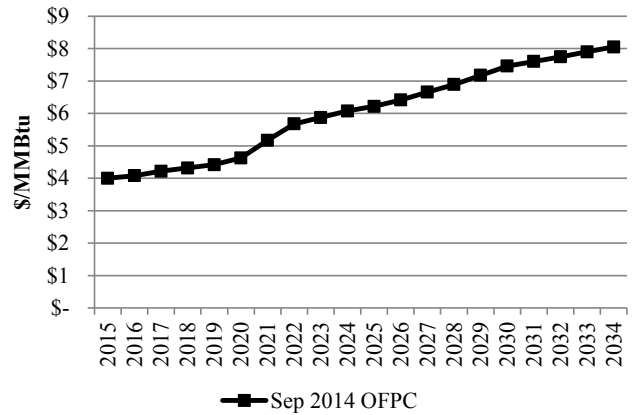

Nominal Average Annual Power Prices (Flat)

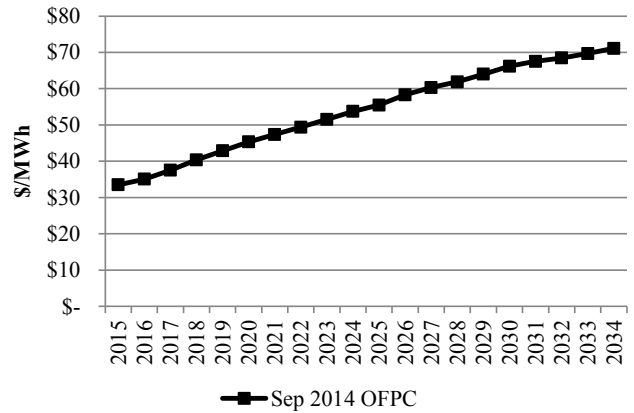

Regional Haze

Sensitivity S-5 reflects Regional Haze Scenario 1, which assumes inter-temporal and fleet trade-off Regional Haze compliance outcomes as shown in the table below. This scenario is for planning purposes recognizing that agency, regulator, and joint owner perspectives on acceptability have not been determined.

Coal Unit	Description
Carbon 1	Shut Down Apr 2015
Carbon 2	Shut Down Apr 2015
Cholla 4	Conversion by Jun 2025
Colstrip 3	SCR by Dec 2023
Colstrip 4	SCR by Dec 2022
Craig 1	SCR by Aug 2021
Craig 2	SCR by Jan 2018
Dave Johnston 1	Shut Down Mar 2019
Dave Johnston 2	Shut Down Dec 2027
Dave Johnston 3	Shut Down Dec 2027
Dave Johnston 4	Shut Down Dec 2032
Hayden 1	SCR by Jun 2015
Hayden 2	SCR by Jun 2016
Hunter 1	SCR by Dec 2021
Hunter 2	Shut Down by Dec 2032
Hunter 3	SCR by Dec 2024
Huntington 1	Shut Down by Dec 2036

Sensitivity: S-05 (High Distributed Generation Forecast)

Huntington 2	Shut Down by Dec 2021
Jim Bridger 1	Shut Down by Dec 2023
Jim Bridger 2	Shut Down by Dec 2032
Jim Bridger 3	SCR by Dec 2015
Jim Bridger 4	SCR by Dec 2016
Naughton 1	Shut Down by Dec 2029
Naughton 2	Shut Down by Dec 2029
Naughton 3	Conversion by Jun 2018; Shut Down by Dec 2029
Wyodak	Shut Down by Dec 2039

SCR = selective catalytic reduction

Federal Tax Incentives

- PTCs expire end of 2013
- ITC of 30% expire end of 2016, thereafter it continues in perpetuity at 10%.

Load Forecast

The medium load forecast will be used. The figure below shows the system coincident peak load forecast before accounting for any potential contribution from DSM or distributed generation resources.

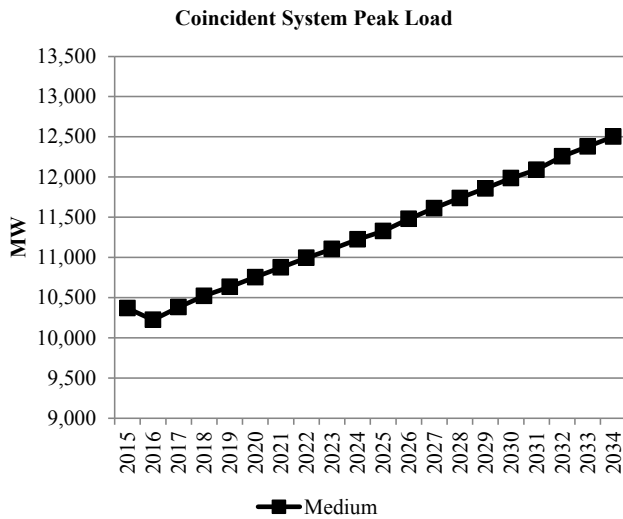

Energy Efficiency (Class 2 DSM)

Base case supply curves and ramp rates with resource selections up to the achievable potential. Class 2 resources that are not selected in any given year are not available for selection in future years. Achievable potential by state and year are summarized below.

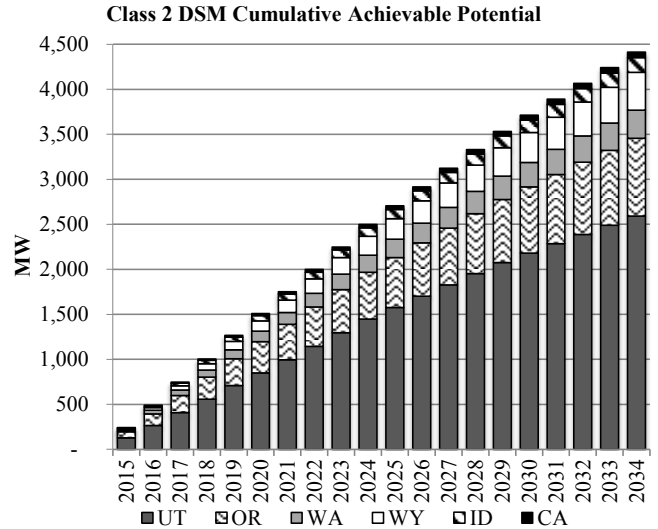

Distributed Generation

High distributed generation penetration is assumed in all states. Distributed generation by state and year are summarized below.

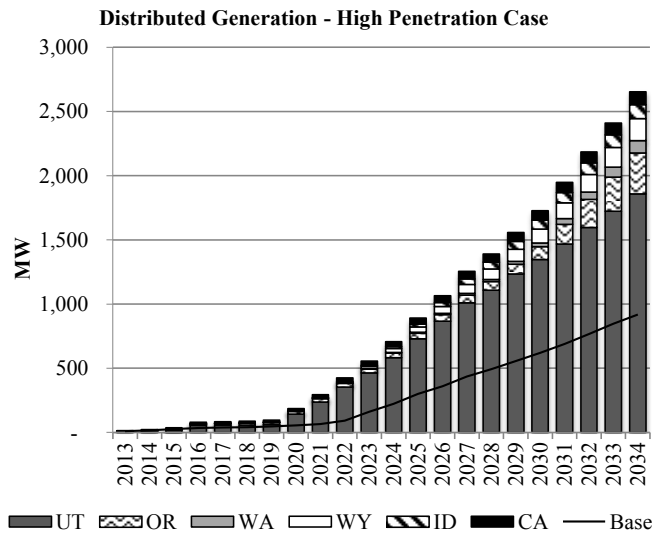

PORTFOLIO SUMMARY

System Optimizer PVRR (\$/m)

System Cost without Transmission Upgrades	\$25,987
Transmission Integration	\$22
Transmission Reinforcement	\$6
Total Cost	\$26,016

Sensitivity: S-05 (High Distributed Generation Forecast)

Resource Portfolio

Cumulative changes to the resource portfolio (new resource additions and resource retirements), represented as nameplate capacity, are summarized in the figure below.

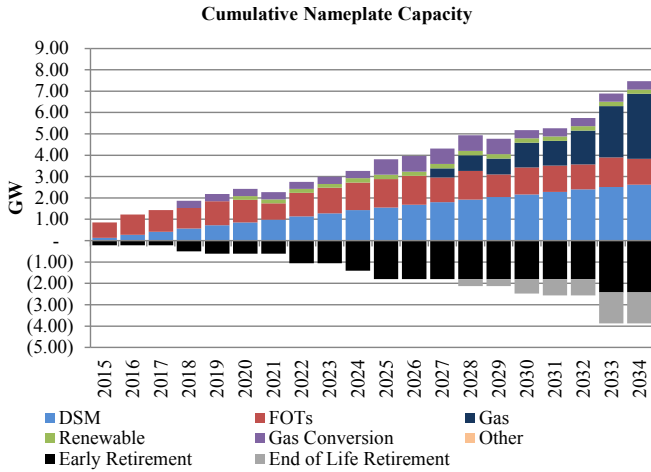

System CO₂ Emissions (System Optimizer)

System CO₂ emissions from System Optimizer are shown alongside those from Cases C05-1 and S-05 in the figure below.

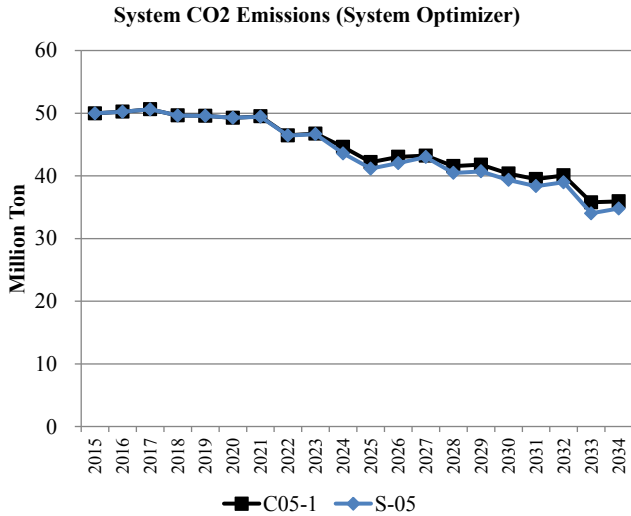

111(d) Compliance Profiles

The following figures summarize how compliance with state emission rate goals is achieved. The sum of each stacked bar represents the fossil emission rate. The net final rate represents the fossil rate after accounting for the emission rate impacts of new thermal (new NGCC units or nuclear, as applicable), re-dispatch of fossil units, energy efficiency (EE), and allocated renewable energy (RE).

PacifiCorp Share of Wyoming Compliance Path (lb/MWh)

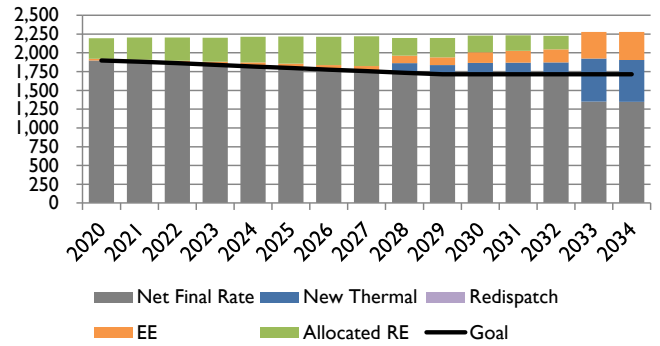

PacifiCorp Share of Wyoming Compliance Path (lb/MWh)

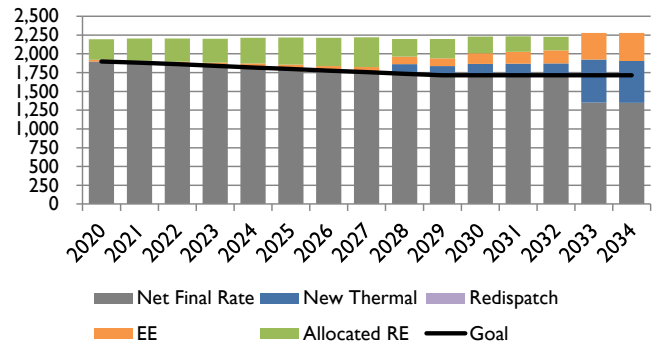

PacifiCorp Share of Wyoming Compliance Path (lb/MWh)

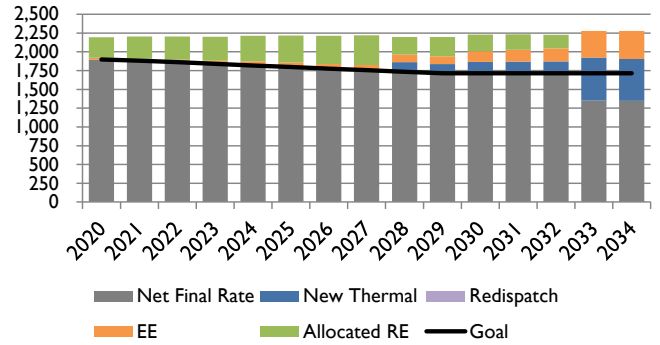

PacifiCorp Share of Wyoming Compliance Path (lb/MWh)

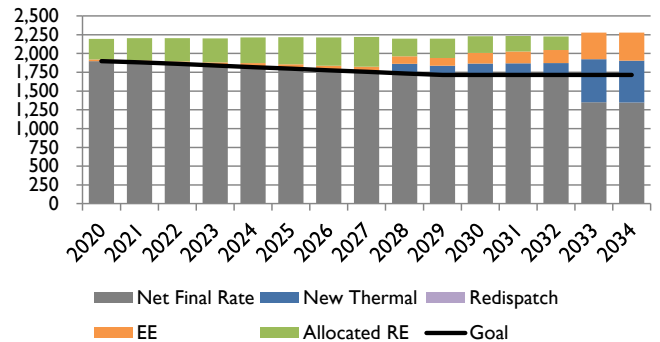

Sensitivity: S-06 (Pumped Storage)

CASE ASSUMPTIONS

Description

Sensitivity S-06 assumes construction of a 400 MW pumped storage facility on the Company's west side. This facility replaced the need for a 423 MW CCT in 2024. As with the other cases this one produced a portfolio that meets PacifiCorp's share of state 111(d) emission rate goals in all states in which PacifiCorp has fossil generation and retail customers. The compliance strategy applied to this case relies on flexible allocation of renewable energy and energy efficiency while prioritizing re-dispatch of fossil generation to achieve incremental emission rate reductions as required. For planning purposes, this case assumes Regional Haze Scenario 1 reflecting potential inter-temporal and fleet trade-off compliance outcomes. This sensitivity is a variant of Core Case C05-1.

Federal CO₂ Policy/Price Signal

Sensitivity S-06 reflects EPA's proposed 111(d) rule with no additional CO₂ price signal. The table below summarizes the interim emission rate goal and the final emission rate target by state assumed to apply to PacifiCorp's system.

State	Interim Goal (Avg. 2020-2029) (lb/MWh)	Final Target (2030 & Beyond) (lb/MWh)
WY	1,808	1,714
UT*	1,378	1,322
OR	407	372
WA	264	215

*EPA's calculation of the target for UT treated PacifiCorp's Lakeside 2 NGCC plant as an existing resource. The emission rate assumed for UT assumes Lake Side 2 is correctly classified as "under construction".

The 111(d) compliance strategy implemented for this case is summarized as follows:

- Flexible allocation of system renewable resources and flexible allocation of cumulative energy efficiency savings beginning 2017 from ID and CA, where PacifiCorp does not own fossil generation.
- Cumulative cost-effective selection of energy efficiency beginning 2017.
- New NGCC generation in WY and UT (new NGCC resources are not allowed in OR, WA, and ID).
- Re-dispatch of existing fossil generation, as required.
- Addition of new renewable resources, as required.

Forward Price Curve

Sensitivity S-6 gas and power prices will utilize medium natural gas prices as well as market price impacts associated with EPA's proposed 111(d) rules. These forecasts begin with the Company's base September 30, 2014 official forward price curve.

Nominal Average Annual Henry Hub Gas Prices

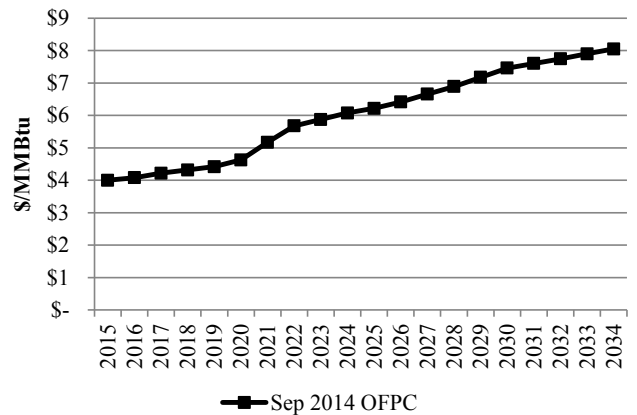

Nominal Average Annual Power Prices (Flat)

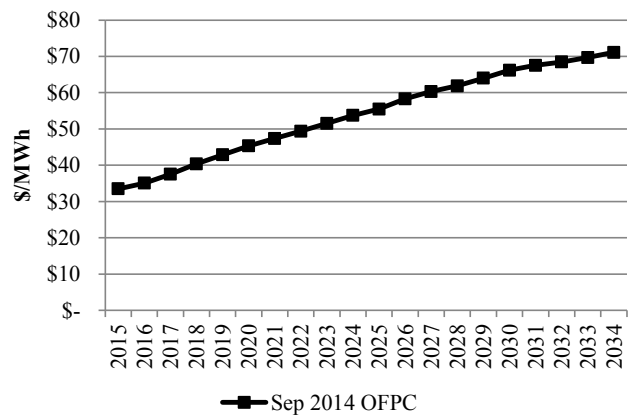

Regional Haze

Sensitivity S-6 reflects Regional Haze Scenario 1, which assumes inter-temporal and fleet trade-off Regional Haze compliance outcomes as shown in the table below. This scenario is for planning purposes recognizing that agency, regulator, and joint owner perspectives on acceptability have not been determined.

Coal Unit	Description
Carbon 1	Shut Down Apr 2015
Carbon 2	Shut Down Apr 2015
Cholla 4	Conversion by Jun 2025
Colstrip 3	SCR by Dec 2023
Colstrip 4	SCR by Dec 2022
Craig 1	SCR by Aug 2021
Craig 2	SCR by Jan 2018
Dave Johnston 1	Shut Down Mar 2019
Dave Johnston 2	Shut Down Dec 2027
Dave Johnston 3	Shut Down Dec 2027
Dave Johnston 4	Shut Down Dec 2032
Hayden 1	SCR by Jun 2015
Hayden 2	SCR by Jun 2016
Hunter 1	SCR by Dec 2021
Hunter 2	Shut Down by Dec 2032
Hunter 3	SCR by Dec 2024
Huntington 1	Shut Down by Dec 2036

Sensitivity: S-06 (Pumped Storage)

Huntington 2	Shut Down by Dec 2021
Jim Bridger 1	Shut Down by Dec 2023
Jim Bridger 2	Shut Down by Dec 2032
Jim Bridger 3	SCR by Dec 2015
Jim Bridger 4	SCR by Dec 2016
Naughton 1	Shut Down by Dec 2029
Naughton 2	Shut Down by Dec 2029
Naughton 3	Conversion by Jun 2018; Shut Down by Dec 2029
Wyodak	Shut Down by Dec 2039

SCR = selective catalytic reduction

Federal Tax Incentives

- PTCs expire end of 2013
- ITC of 30% expire end of 2016, thereafter it continues in perpetuity at 10%.

Load Forecast

The medium load forecast will be used. The figure below shows the system coincident peak load forecast before accounting for any potential contribution from DSM or distributed generation resources.

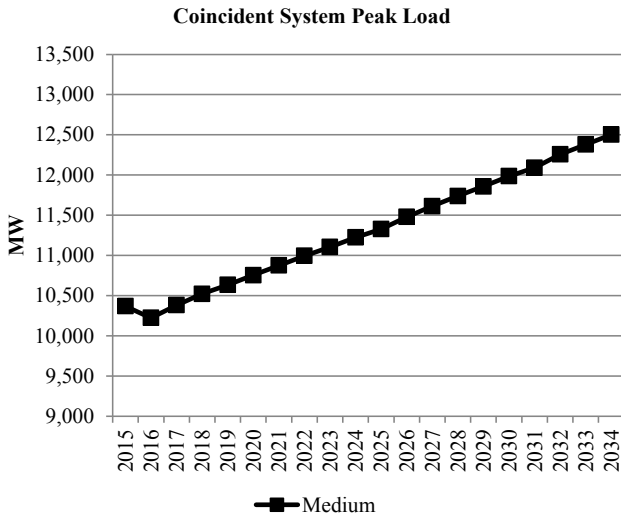

Energy Efficiency (Class 2 DSM)

Base case supply curves and ramp rates with resource selections up to the achievable potential. Class 2 resources that are not selected in any given year are not available for selection in future years. Achievable potential by state and year are summarized below.

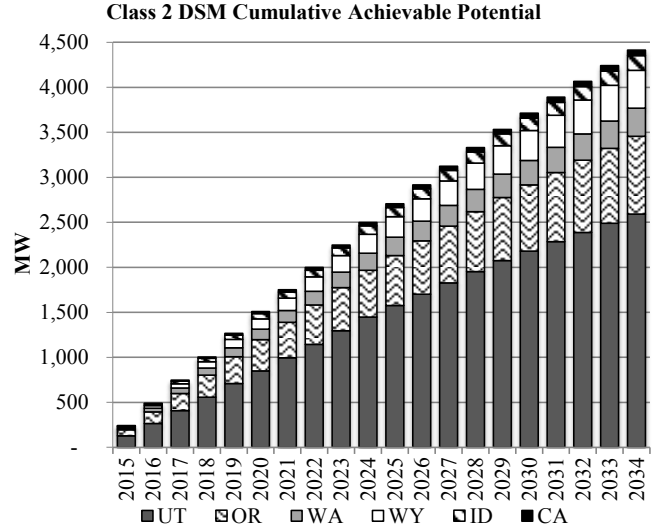

Distributed Generation

Base case distributed generation penetration is assumed in all states. Distributed generation by state and year are summarized below.

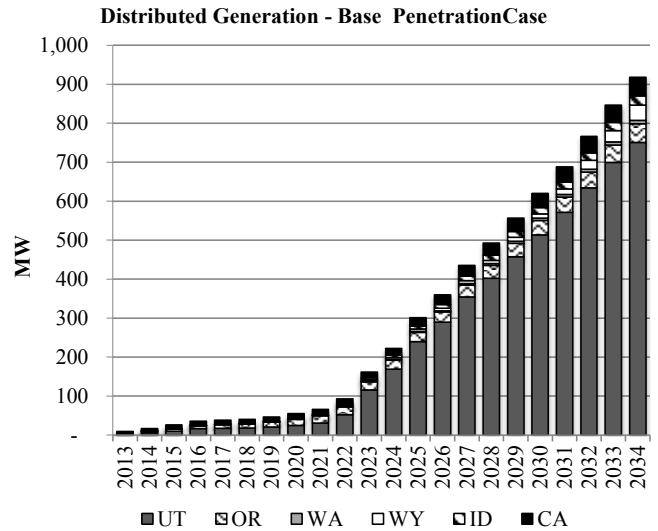

PORTFOLIO SUMMARY

System Optimizer PVRR (\$m)

System Cost without Transmission Upgrades	\$27,022
Transmission Integration	\$66
Transmission Reinforcement	\$6
Total Cost	\$27,094

Sensitivity: S-06 (Pumped Storage)

Resource Portfolio

Cumulative changes to the resource portfolio (new resource additions and resource retirements), represented as nameplate capacity, are summarized in the figure below.

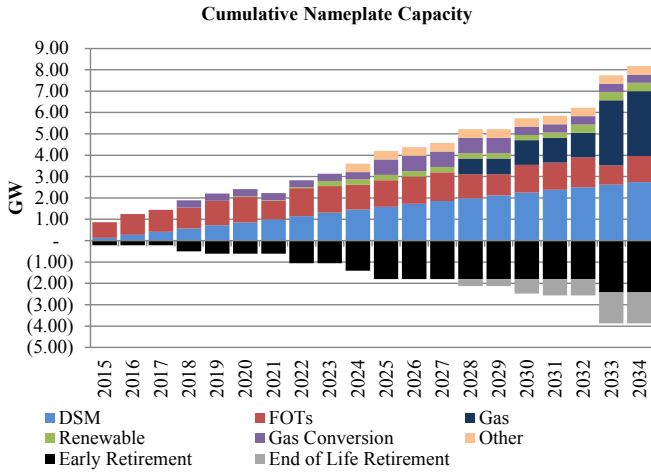

System CO₂ Emissions (System Optimizer)

System CO₂ emissions from System Optimizer are shown alongside those from Cases C05-1 and S-06 in the figure below.

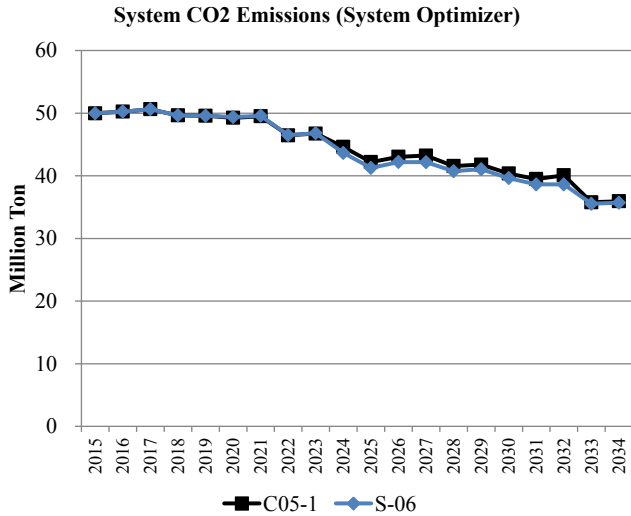

111(d) Compliance Profiles

The following figures summarize how compliance with state emission rate goals is achieved. The sum of each stacked bar represents the fossil emission rate. The net final rate represents the fossil rate after accounting for the emission rate impacts of new thermal (new NGCC units or nuclear, as applicable), re-dispatch of fossil units, energy efficiency (EE), and allocated renewable energy (RE).

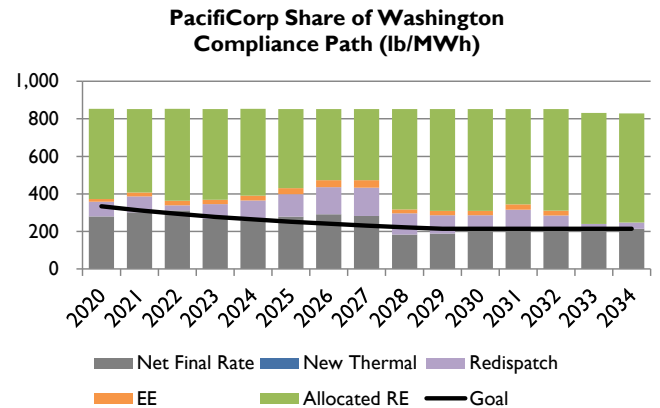
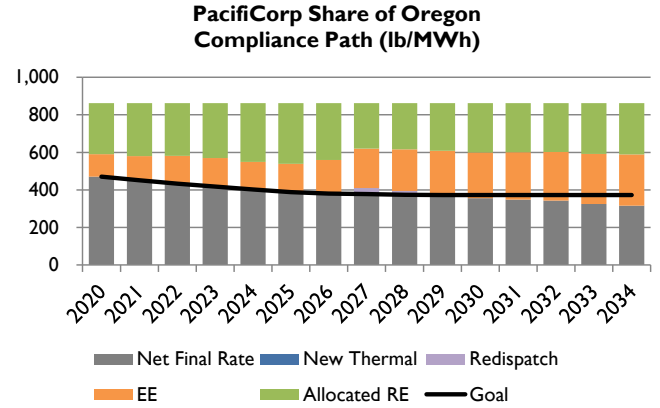
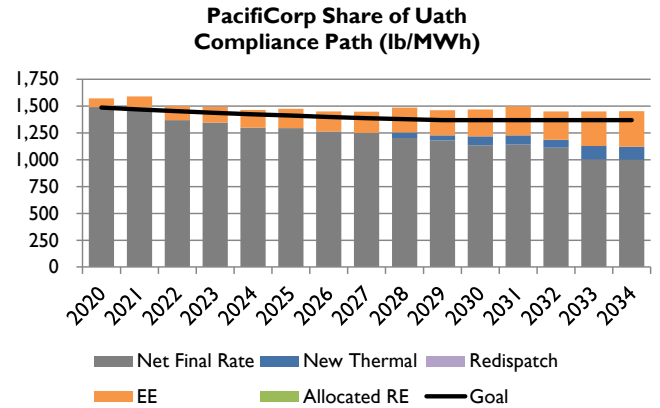
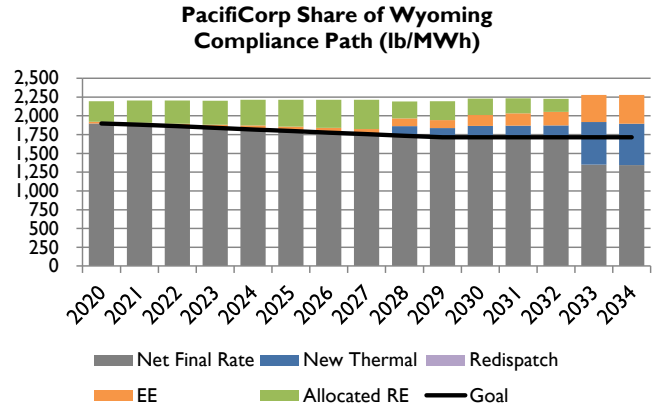

Sensitivity: S-07 (Energy Gateway 2)

CASE ASSUMPTIONS

Description

Sensitivity S-07 is one of two Energy Gateway sensitivities. This assumes construction of the following segments, and in-service dates; Segment C (2013), Segment D (2022), Segment G (2015). A portfolio was produced that meets PacifiCorp's share of state 111(d) emission rate goals in all states in which PacifiCorp has fossil generation and retail customers. The compliance strategy applied to this case relies on flexible allocation of renewable energy and energy efficiency while prioritizing re-dispatch of fossil generation to achieve incremental emission rate reductions as required. For planning purposes, this case assumes Regional Haze Scenario 1 reflecting potential inter-temporal and fleet trade-off compliance outcomes. This sensitivity is a variant of Core Case C07-1, a portfolio with a higher penetration of renewable resources.

Federal CO₂ Policy/Price Signal

Sensitivity S-07 reflects EPA's proposed 111(d) rule with no additional CO₂ price signal. The table below summarizes the interim emission rate goal and the final emission rate target by state assumed to apply to PacifiCorp's system.

State	Interim Goal (Avg. 2020-2029) (lb/MWh)	Final Target (2030 & Beyond) (lb/MWh)
WY	1,808	1,714
UT*	1,378	1,322
OR	407	372
WA	264	215

*EPA's calculation of the target for UT treated PacifiCorp's Lakeside 2 NGCC plant as an existing resource. The emission rate assumed for UT assumes Lake Side 2 is correctly classified as "under construction".

The 111(d) compliance strategy implemented for this case is summarized as follows:

- Flexible allocation of system renewable resources and flexible allocation of cumulative energy efficiency savings beginning 2017 from ID and CA, where PacifiCorp does not own fossil generation.
- Cumulative cost-effective selection of energy efficiency beginning 2017.
- New NGCC generation in WY and UT (new NGCC resources are not allowed in OR, WA, and ID).
- Re-dispatch of existing fossil generation, as required.
- Addition of new renewable resources, as required.

Forward Price Curve

Sensitivity S-7 gas and power prices will utilize medium natural gas prices as well as market price impacts associated with EPA's proposed 111(d) rules. These forecasts begin with the Company's base September 30, 2014 official forward price curve.

Nominal Average Annual Henry Hub Gas Prices

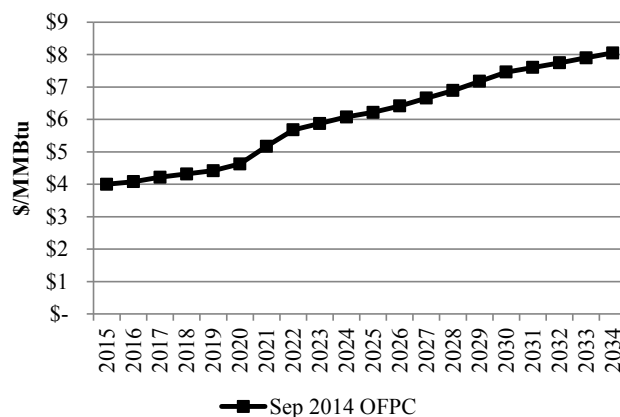

Nominal Average Annual Power Prices (Flat)

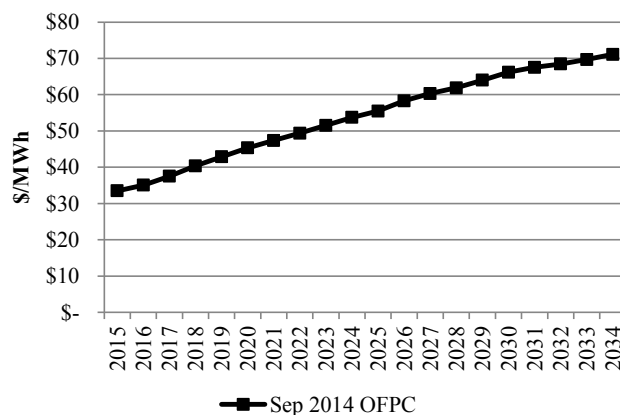

Regional Haze

Sensitivity S-7 reflects Regional Haze Scenario 1, which assumes inter-temporal and fleet trade-off Regional Haze compliance outcomes as shown in the table below. This scenario is for planning purposes recognizing that agency, regulator, and joint owner perspectives on acceptability have not been determined.

Coal Unit	Description
Carbon 1	Shut Down Apr 2015
Carbon 2	Shut Down Apr 2015
Cholla 4	Conversion by Jun 2025
Colstrip 3	SCR by Dec 2023
Colstrip 4	SCR by Dec 2022
Craig 1	SCR by Aug 2021
Craig 2	SCR by Jan 2018
Dave Johnston 1	Shut Down Mar 2019
Dave Johnston 2	Shut Down Dec 2027
Dave Johnston 3	Shut Down Dec 2027
Dave Johnston 4	Shut Down Dec 2032
Hayden 1	SCR by Jun 2015
Hayden 2	SCR by Jun 2016
Hunter 1	SCR by Dec 2021
Hunter 2	Shut Down by Dec 2032
Hunter 3	SCR by Dec 2024
Huntington 1	Shut Down by Dec 2036

Sensitivity: S-07 (Energy Gateway 2)

Huntington 2	Shut Down by Dec 2021
Jim Bridger 1	Shut Down by Dec 2023
Jim Bridger 2	Shut Down by Dec 2032
Jim Bridger 3	SCR by Dec 2015
Jim Bridger 4	SCR by Dec 2016
Naughton 1	Shut Down by Dec 2029
Naughton 2	Shut Down by Dec 2029
Naughton 3	Conversion by Jun 2018; Shut Down by Dec 2029
Wyodak	Shut Down by Dec 2039

SCR = selective catalytic reduction

Federal Tax Incentives

- PTCs expire end of 2013
- ITC of 30% expire end of 2016, thereafter it continues in perpetuity at 10%.

Load Forecast

The medium load forecast will be used. The figure below shows the system coincident peak load forecast before accounting for any potential contribution from DSM or distributed generation resources.

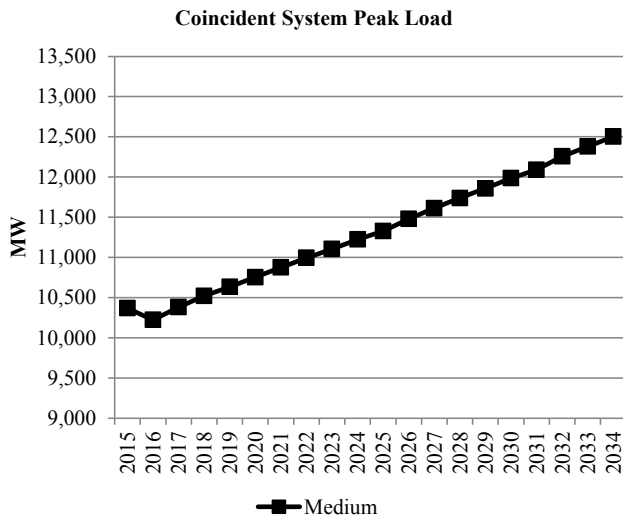

Energy Efficiency (Class 2 DSM)

Base case supply curves and ramp rates with resource selections up to the achievable potential. Class 2 resources that are not selected in any given year are not available for selection in future years. Achievable potential by state and year are summarized below.

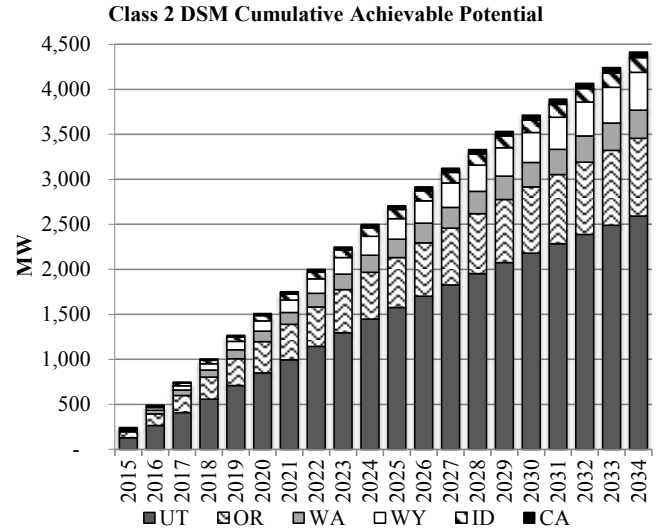

Distributed Generation

Base case distributed generation penetration is assumed in all states. Distributed generation by state and year are summarized below.

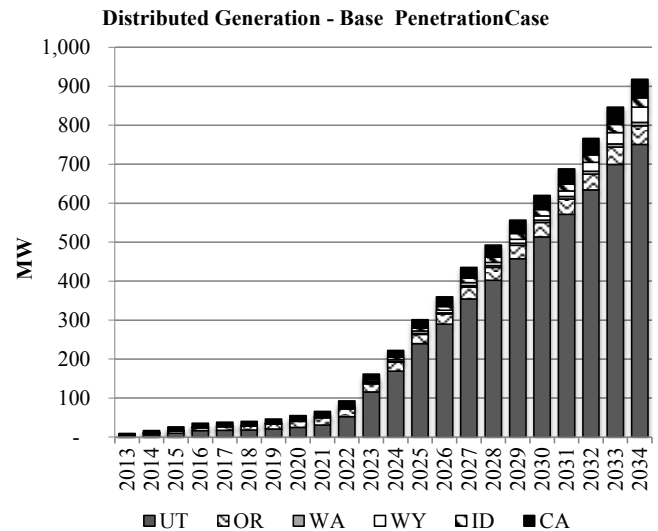

PORTFOLIO SUMMARY

System Optimizer PVRR (\$m)

System Cost* without Transmission Upgrades	\$29,221
Transmission Integration	\$0
Transmission Reinforcement	\$6
Total Cost	\$29,227

*System costs incorporate EG-2 build out.

Sensitivity: S-07 (Energy Gateway 2)

Resource Portfolio

Cumulative changes to the resource portfolio (new resource additions and resource retirements), represented as nameplate capacity, are summarized in the figure below.

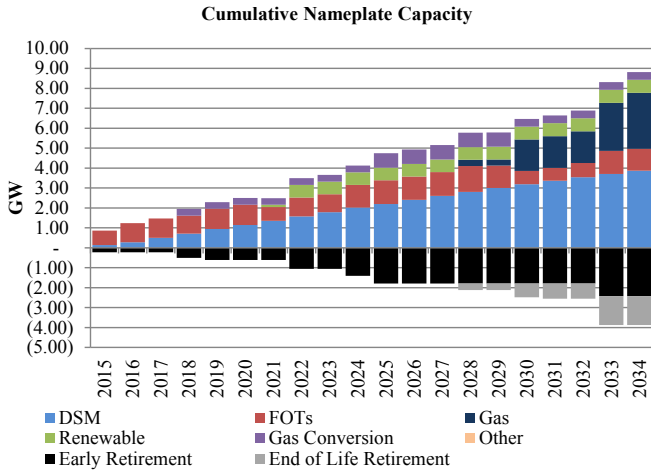

System CO₂ Emissions (System Optimizer)

System CO₂ emissions from System Optimizer are shown alongside those from Cases C07-1 and S-07 in the figure below.

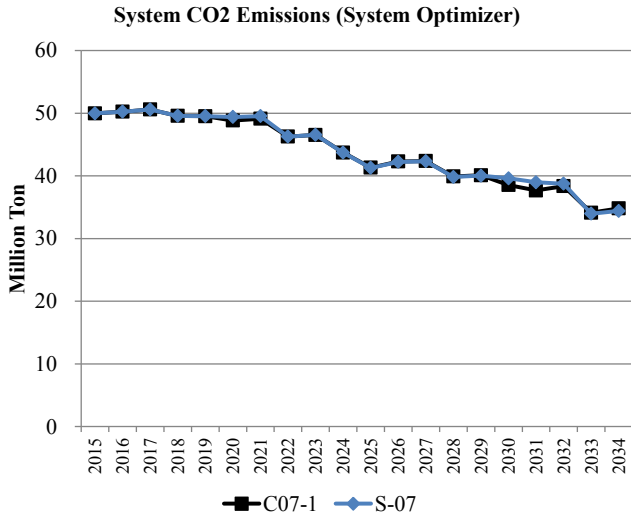

111(d) Compliance Profiles

The following figures summarize how compliance with state emission rate goals is achieved. The sum of each stacked bar represents the fossil emission rate. The net final rate represents the fossil rate after accounting for the emission rate impacts of new thermal (new NGCC units or nuclear, as applicable), re-dispatch of fossil units, energy efficiency (EE), and allocated renewable energy (RE).

PacifiCorp Share of Wyoming Compliance Path (lb/MWh)

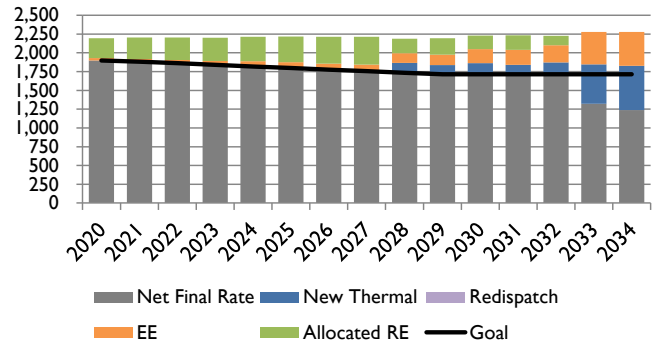

PacifiCorp Share of Utah Compliance Path (lb/MWh)

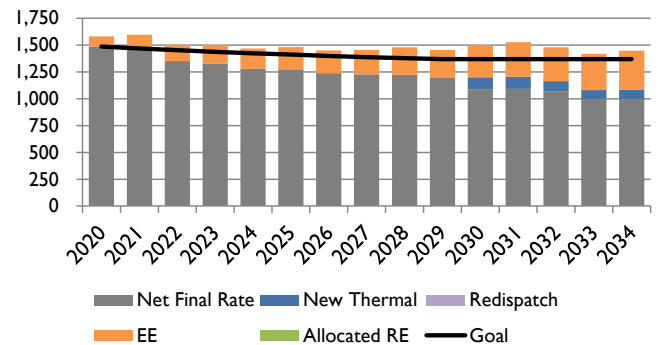

PacifiCorp Share of Oregon Compliance Path (lb/MWh)

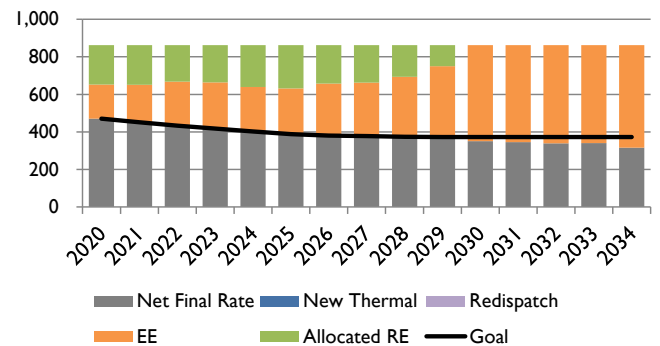

PacifiCorp Share of Washington Compliance Path (lb/MWh)

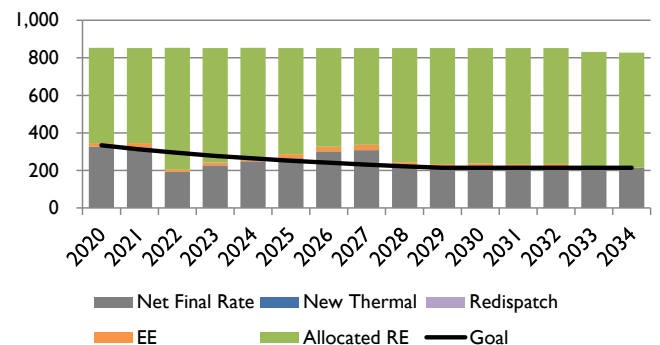

Sensitivity: S-08 (Energy Gateway 5)

CASE ASSUMPTIONS

Description

Sensitivity S-08 is one of two Energy Gateway sensitivities. This assumes construction of the following segments, and in-service dates; Segment C (2013), Segment D (2022), Segment E (2024), Segment G (2015), Segment F (2023). A portfolio was produced that meets PacifiCorp’s share of state 111(d) emission rate goals in all states in which PacifiCorp has fossil generation and retail customers. The compliance strategy applied to this case relies on flexible allocation of renewable energy and energy efficiency while prioritizing re-dispatch of fossil generation to achieve incremental emission rate reductions as required. For planning purposes, this case assumes Regional Haze Scenario 1 reflecting potential inter-temporal and fleet trade-off compliance outcomes. This sensitivity is a variant of Core Case C07-1, a portfolio with a higher penetration of renewable resources.

Federal CO₂ Policy/Price Signal

Sensitivity S-08 reflects EPA’s proposed 111(d) rule with no additional CO₂ price signal. The table below summarizes the interim emission rate goal and the final emission rate target by state assumed to apply to PacifiCorp’s system.

State	Interim Goal (Avg. 2020-2029) (lb/MWh)	Final Target (2030 & Beyond) (lb/MWh)
WY	1,808	1,714
UT*	1,378	1,322
OR	407	372
WA	264	215

*EPA’s calculation of the target for UT treated PacifiCorp’s Lakeside 2 NGCC plant as an existing resource. The emission rate assumed for UT assumes Lake Side 2 is correctly classified as “under construction”.

The 111(d) compliance strategy implemented for this case is summarized as follows:

- Flexible allocation of system renewable resources and flexible allocation of cumulative energy efficiency savings beginning 2017 from ID and CA, where PacifiCorp does not own fossil generation.
- Cumulative cost-effective selection of energy efficiency beginning 2017.
- New NGCC generation in WY and UT (new NGCC resources are not allowed in OR, WA, and ID).
- Re-dispatch of existing fossil generation, as required.
- Addition of new renewable resources, as required.

Forward Price Curve

Sensitivity S-8 gas and power prices will utilize medium natural gas prices as well as market price impacts associated with EPA’s proposed 111(d) rules. These forecasts begin with the Company’s base September 30, 2014 official forward price curve.

Nominal Average Annual Henry Hub Gas Prices

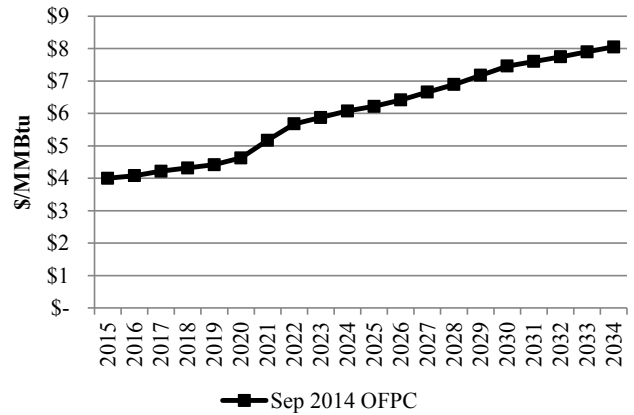

Nominal Average Annual Power Prices (Flat)

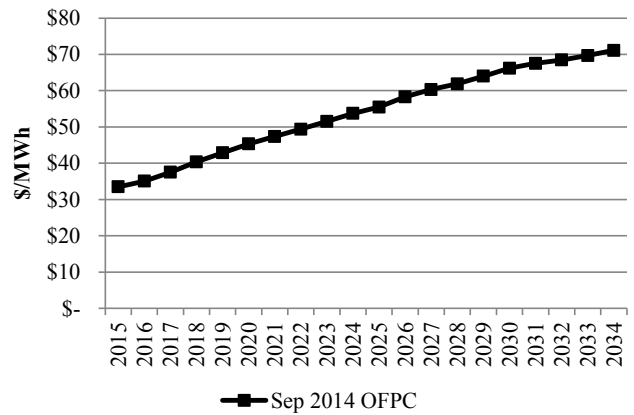

Regional Haze

Sensitivity S-8 reflects Regional Haze Scenario 1, which assumes inter-temporal and fleet trade-off Regional Haze compliance outcomes as shown in the table below. This scenario is for planning purposes recognizing that agency, regulator, and joint owner perspectives on acceptability have not been determined.

Coal Unit	Description
Carbon 1	Shut Down Apr 2015
Carbon 2	Shut Down Apr 2015
Cholla 4	Conversion by Jun 2025
Colstrip 3	SCR by Dec 2023
Colstrip 4	SCR by Dec 2022
Craig 1	SCR by Aug 2021
Craig 2	SCR by Jan 2018
Dave Johnston 1	Shut Down Mar 2019
Dave Johnston 2	Shut Down Dec 2027
Dave Johnston 3	Shut Down Dec 2027
Dave Johnston 4	Shut Down Dec 2032
Hayden 1	SCR by Jun 2015
Hayden 2	SCR by Jun 2016
Hunter 1	SCR by Dec 2021
Hunter 2	Shut Down by Dec 2032
Hunter 3	SCR by Dec 2024
Huntington 1	Shut Down by Dec 2036

Sensitivity: S-08 (Energy Gateway 5)

Huntington 2	Shut Down by Dec 2021
Jim Bridger 1	Shut Down by Dec 2023
Jim Bridger 2	Shut Down by Dec 2032
Jim Bridger 3	SCR by Dec 2015
Jim Bridger 4	SCR by Dec 2016
Naughton 1	Shut Down by Dec 2029
Naughton 2	Shut Down by Dec 2029
Naughton 3	Conversion by Jun 2018; Shut Down by Dec 2029
Wyodak	Shut Down by Dec 2039

SCR = selective catalytic reduction

Federal Tax Incentives

- PTCs expire end of 2013
- ITC of 30% expire end of 2016, thereafter it continues in perpetuity at 10%.

Load Forecast

The medium load forecast will be used. The figure below shows the system coincident peak load forecast before accounting for any potential contribution from DSM or distributed generation resources.

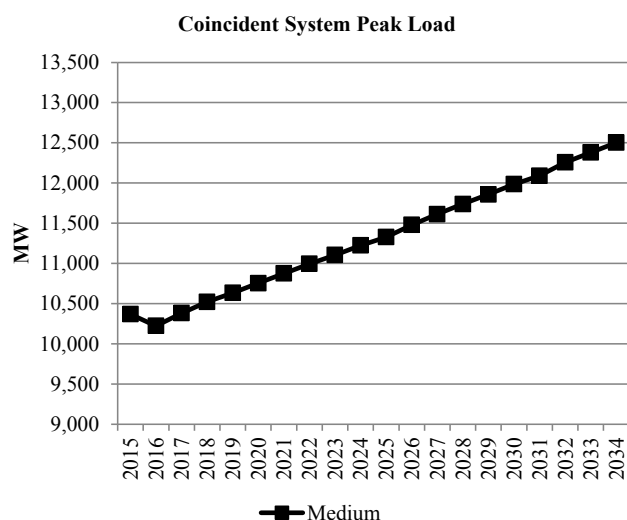

Energy Efficiency (Class 2 DSM)

Base case supply curves and ramp rates with resource selections up to the achievable potential. Class 2 resources that are not selected in any given year are not available for selection in future years. Achievable potential by state and year are summarized below.

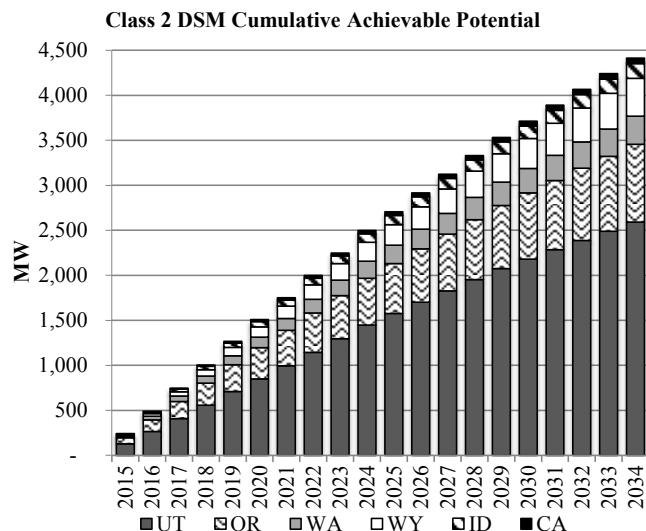

Distributed Generation

Base case distributed generation penetration is assumed in all states. Distributed generation by state and year are summarized below.

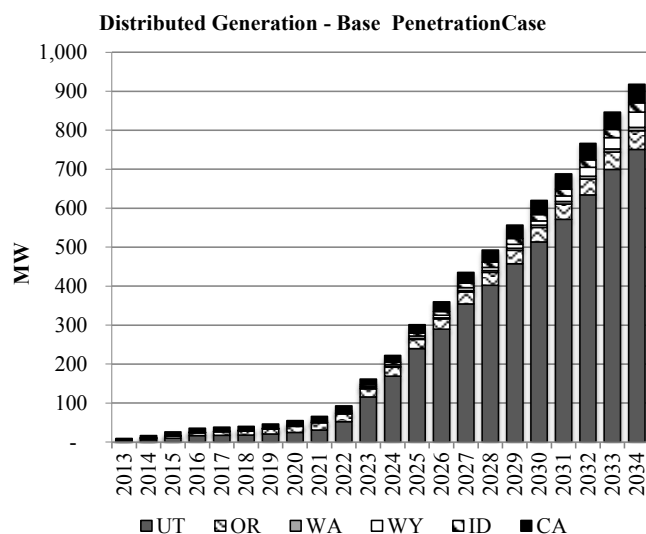

PORTFOLIO SUMMARY

System Optimizer PVRR (\$m)

System Cost* without Transmission Upgrades	\$29,966
Transmission Integration	\$5
Transmission Reinforcement	\$6
Total Cost	\$29,977

*System costs incorporate EG-5 build out.

Sensitivity: S-08 (Energy Gateway 5)

Resource Portfolio

Cumulative changes to the resource portfolio (new resource additions and resource retirements), represented as nameplate capacity, are summarized in the figure below.

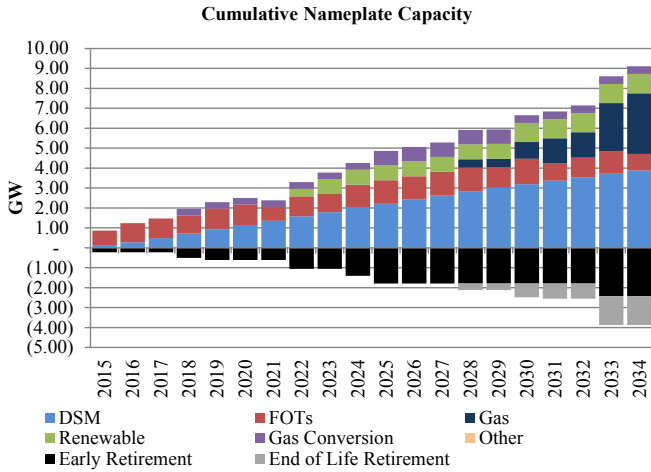

System CO₂ Emissions (System Optimizer)

System CO₂ emissions from System Optimizer are shown alongside those from Cases C07-1 and S-08 in the figure below.

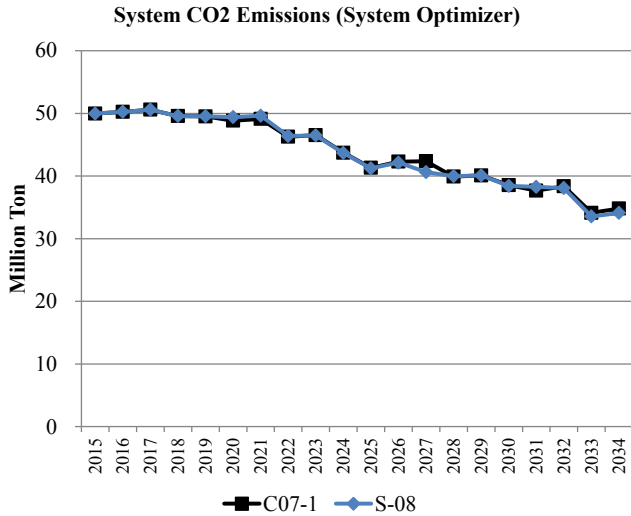

111(d) Compliance Profiles

The following figures summarize how compliance with state emission rate goals is achieved. The sum of each stacked bar represents the fossil emission rate. The net final rate represents the fossil rate after accounting for the emission rate impacts of new thermal (new NGCC units or nuclear, as applicable), re-dispatch of fossil units, energy efficiency (EE), and allocated renewable energy (RE).

PacifiCorp Share of Wyoming Compliance Path (lb/MWh)

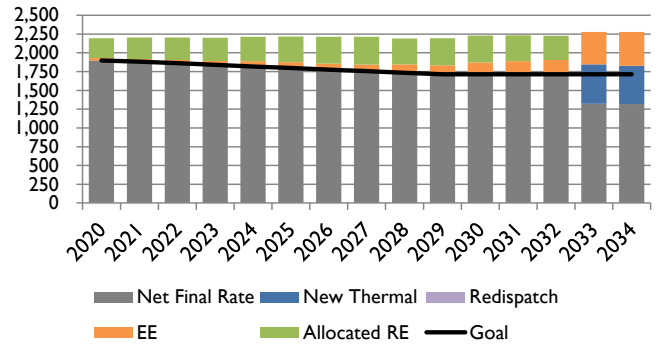

PacifiCorp Share of Utah Compliance Path (lb/MWh)

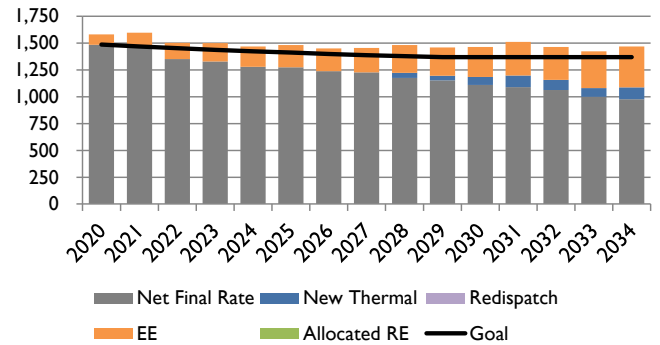

PacifiCorp Share of Oregon Compliance Path (lb/MWh)

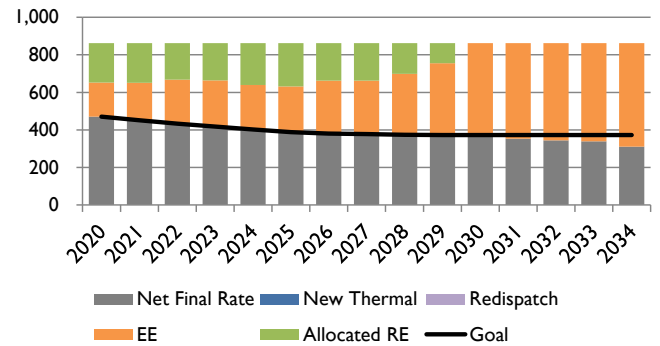

PacifiCorp Share of Washington Compliance Path (lb/MWh)

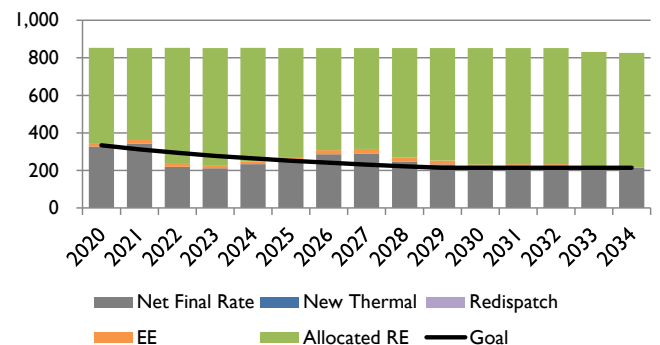

Sensitivity: S-09 (PTC Extension)

CASE ASSUMPTIONS

Description

Sensitivity S-09 assumes extension of the production tax credit (PTC) through the study period. The PTC starts at \$2.30 per kilowatt-hour beginning in 2015 and escalates at inflation through 2034, as opposed to having expired at end of 2013. The portfolio produced meets PacifiCorp's share of state 111(d) emission rate goals in all states in which PacifiCorp has fossil generation and retail customers. The compliance strategy applied to this case relies on flexible allocation of renewable energy and energy efficiency while prioritizing re-dispatch of fossil generation to achieve incremental emission rate reductions as required. For planning purposes, this case assumes Regional Haze Scenario 1 reflecting potential inter-temporal and fleet trade-off compliance outcomes. This sensitivity is a variant of Core Case C05-1.

Federal CO₂ Policy/Price Signal

Sensitivity S-09 reflects EPA's proposed 111(d) rule with no additional CO₂ price signal. The table below summarizes the interim emission rate goal and the final emission rate target by state assumed to apply to PacifiCorp's system.

State	Interim Goal (Avg. 2020-2029) (lb/MWh)	Final Target (2030 & Beyond) (lb/MWh)
WY	1,808	1,714
UT*	1,378	1,322
OR	407	372
WA	264	215

*EPA's calculation of the target for UT treated PacifiCorp's Lakeside 2 NGCC plant as an existing resource. The emission rate assumed for UT assumes Lake Side 2 is correctly classified as "under construction".

The 111(d) compliance strategy implemented for this case is summarized as follows:

- Flexible allocation of system renewable resources and flexible allocation of cumulative energy efficiency savings beginning 2017 from ID and CA, where PacifiCorp does not own fossil generation.
- Cumulative cost-effective selection of energy efficiency beginning 2017.
- New NGCC generation in WY and UT (new NGCC resources are not allowed in OR, WA, and ID).
- Re-dispatch of existing fossil generation, as required.
- Addition of new renewable resources, as required.

Forward Price Curve

Sensitivity S-9 gas and power prices will utilize medium natural gas prices as well as market price impacts associated with EPA's proposed 111(d) rules. These forecasts begin with the Company's base September 30, 2014 official forward price curve.

Nominal Average Annual Henry Hub Gas Prices

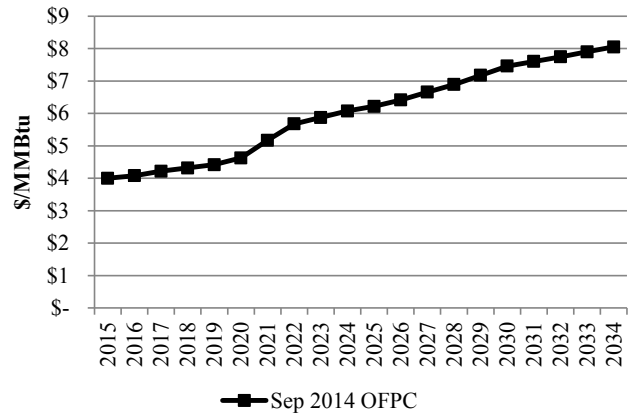

Nominal Average Annual Power Prices (Flat)

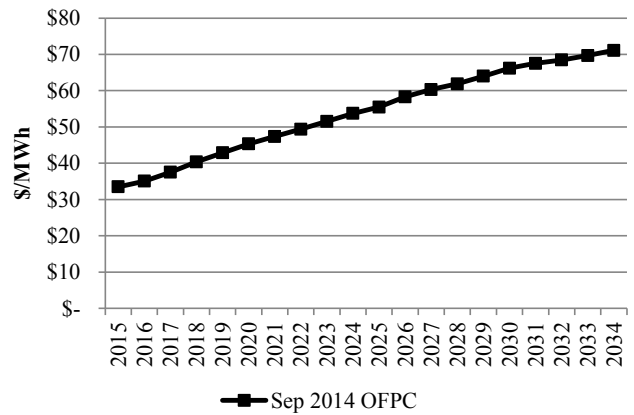

Regional Haze

Sensitivity S-9 reflects Regional Haze Scenario 1, which assumes inter-temporal and fleet trade-off Regional Haze compliance outcomes as shown in the table below. This scenario is for planning purposes recognizing that agency, regulator, and joint owner perspectives on acceptability have not been determined.

Coal Unit	Description
Carbon 1	Shut Down Apr 2015
Carbon 2	Shut Down Apr 2015
Cholla 4	Conversion by Jun 2025
Colstrip 3	SCR by Dec 2023
Colstrip 4	SCR by Dec 2022
Craig 1	SCR by Aug 2021
Craig 2	SCR by Jan 2018
Dave Johnston 1	Shut Down Mar 2019
Dave Johnston 2	Shut Down Dec 2027
Dave Johnston 3	Shut Down Dec 2027
Dave Johnston 4	Shut Down Dec 2032
Hayden 1	SCR by Jun 2015
Hayden 2	SCR by Jun 2016
Hunter 1	SCR by Dec 2021
Hunter 2	Shut Down by Dec 2032
Hunter 3	SCR by Dec 2024
Huntington 1	Shut Down by Dec 2036

Sensitivity: S-09 (PTC Extension)

Huntington 2	Shut Down by Dec 2021
Jim Bridger 1	Shut Down by Dec 2023
Jim Bridger 2	Shut Down by Dec 2032
Jim Bridger 3	SCR by Dec 2015
Jim Bridger 4	SCR by Dec 2016
Naughton 1	Shut Down by Dec 2029
Naughton 2	Shut Down by Dec 2029
Naughton 3	Conversion by Jun 2018; Shut Down by Dec 2029
Wyodak	Shut Down by Dec 2039

SCR = selective catalytic reduction

Federal Tax Incentives

- PTCs continues in perpetuity at \$2.30 per kilowatt-hour (\$2015)
- ITC of 30% expire end of 2016, thereafter it continues in perpetuity at 10%.

Load Forecast

The medium load forecast will be used. The figure below shows the system coincident peak load forecast before accounting for any potential contribution from DSM or distributed generation resources.

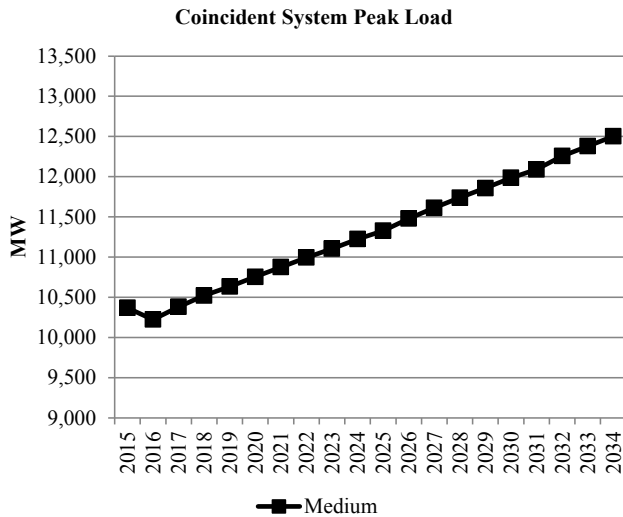

Energy Efficiency (Class 2 DSM)

Base case supply curves and ramp rates with resource selections up to the achievable potential. Class 2 resources that are not selected in any given year are not available for selection in future years. Achievable potential by state and year are summarized below.

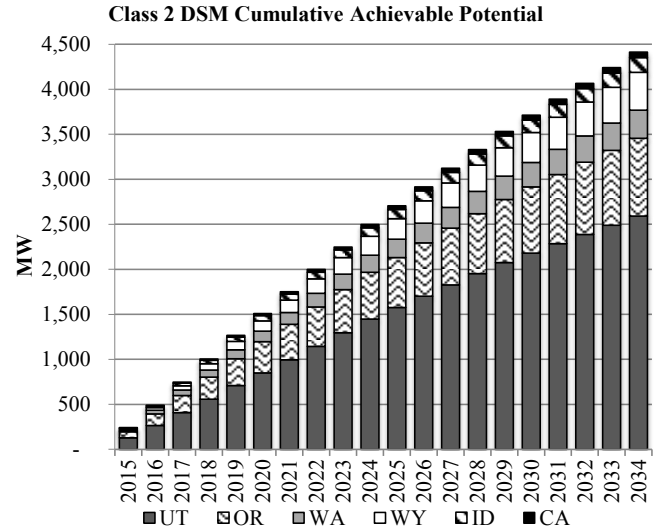

Distributed Generation

Base case distributed generation penetration is assumed in all states. Distributed generation by state and year are summarized below.

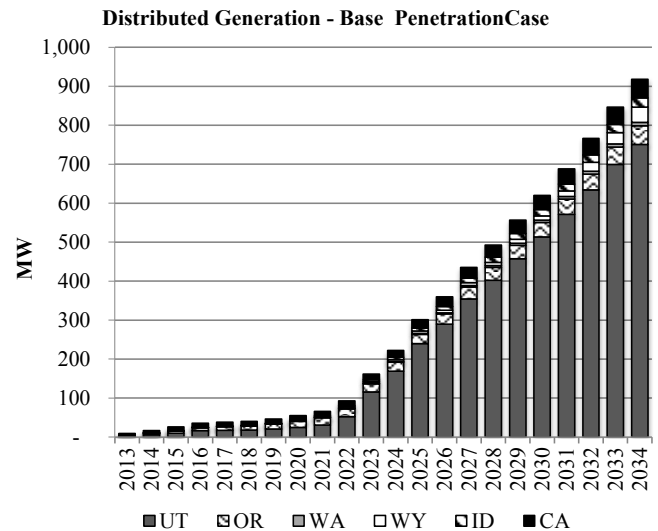

PORTFOLIO SUMMARY

System Optimizer PVRR (\$m)

System Cost without Transmission Upgrades	\$26,416
Transmission Integration	\$19
Transmission Reinforcement	\$7
Total Cost	\$26,443

Sensitivity: S-09 (PTC Extension)

Resource Portfolio

Cumulative changes to the resource portfolio (new resource additions and resource retirements), represented as nameplate capacity, are summarized in the figure below.

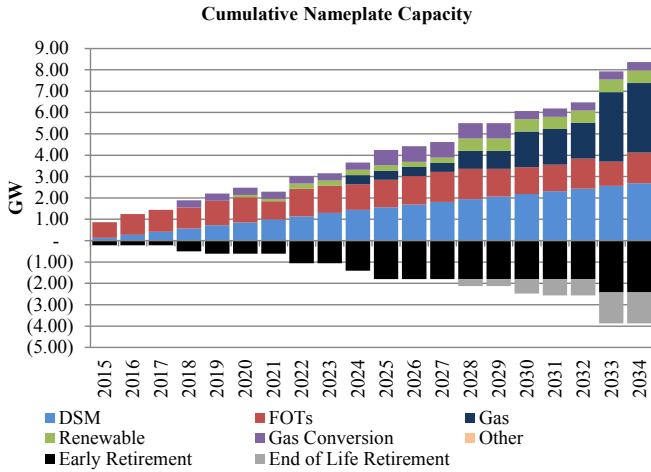

System CO₂ Emissions (System Optimizer)

System CO₂ emissions from System Optimizer are shown alongside those from Cases C05-1 and S-09 in the figure below.

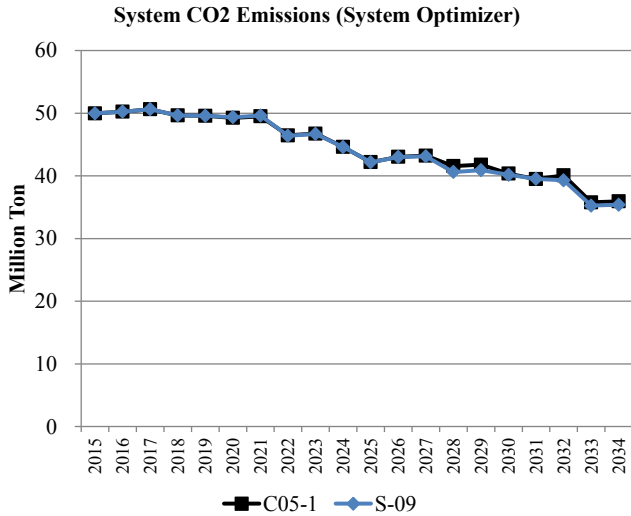

111(d) Compliance Profiles

The following figures summarize how compliance with state emission rate goals is achieved. The sum of each stacked bar represents the fossil emission rate. The net final rate represents the fossil rate after accounting for the emission rate impacts of new thermal (new NGCC units or nuclear, as applicable), re-dispatch of fossil units, energy efficiency (EE), and allocated renewable energy (RE).

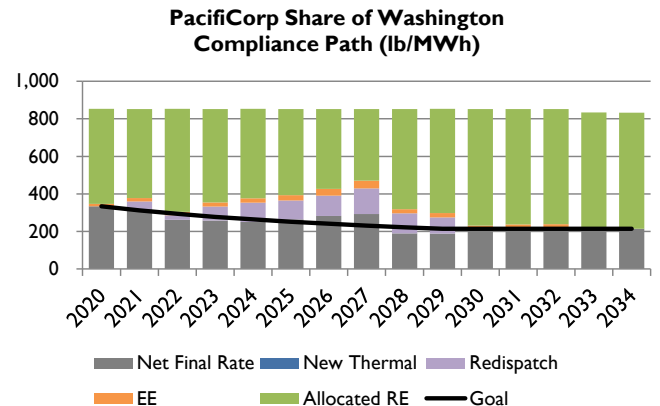
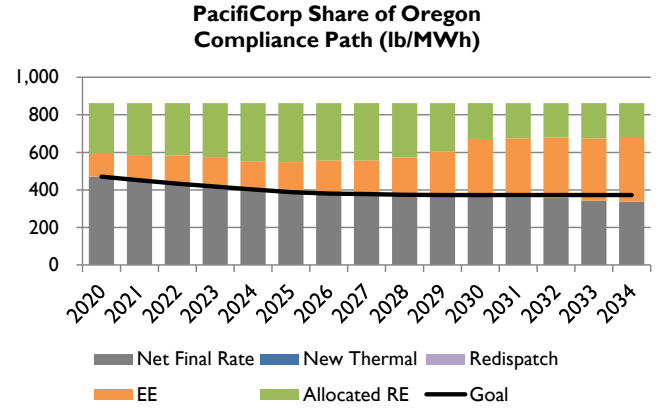
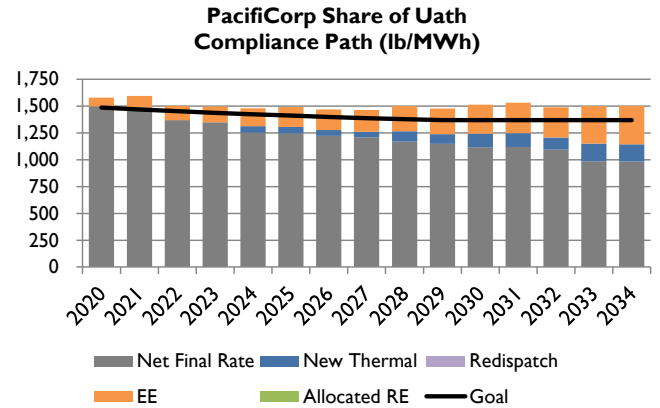
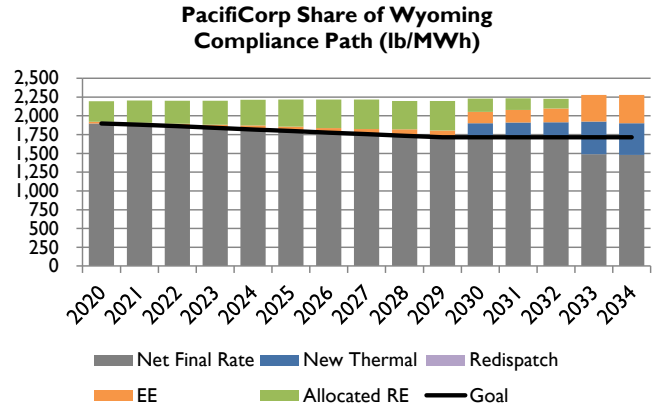

Sensitivity: S-10 (Separate East/West BAAs)

CASE ASSUMPTIONS

Description

Sensitivity S-10 assumes separate balancing authority areas (BAA) for the Company's East and West territory. Independent portfolios were developed for each area, focusing on summer peak needs in the East, and winter peak needs in the West. This sensitivity uses assumptions for Regional Haze scenario 3 as well as meeting all renewable and 111(d) requirements for both BAAs. A benchmark portfolio was also developed using the same assumptions, consistent with the draft preferred portfolio. The benchmark portfolio meets PacifiCorp's share of state 111(d) emission rate goals in all states in which PacifiCorp has fossil generation and retail customers. The compliance strategy applied to each BAA relies on flexible allocation of renewable energy and energy efficiency while prioritizing re-dispatch of fossil generation to achieve incremental emission rate reductions as required. This sensitivity is a variant of Core Case C05-3.

Federal CO₂ Policy/Price Signal

Sensitivity S-10 reflects EPA's proposed 111(d) rule with no additional CO₂ price signal. The table below summarizes the interim emission rate goal and the final emission rate target by state assumed to apply to PacifiCorp's system.

State	Interim Goal (Avg. 2020-2029) (lb/MWh)	Final Target (2030 & Beyond) (lb/MWh)
WY	1,808	1,714
UT*	1,378	1,322
OR	407	372
WA	264	215

*EPA's calculation of the target for UT treated PacifiCorp's Lakeside 2 NGCC plant as an existing resource. The emission rate assumed for UT assumes Lake Side 2 is correctly classified as "under construction".

The 111(d) compliance strategy implemented for this case is summarized as follows:

- Flexible allocation of system renewable resources and flexible allocation of cumulative energy efficiency savings beginning 2017 from ID and CA, where PacifiCorp does not own fossil generation.
- Cumulative cost-effective selection of energy efficiency beginning 2017.
- New NGCC generation in WY and UT (new NGCC resources are not allowed in OR, WA, and ID).
- Re-dispatch of existing fossil generation, as required.
- Addition of new renewable resources, as required.

Forward Price Curve

Sensitivity S-10 gas and power prices will utilize medium natural gas prices as well as market price impacts associated with EPA's proposed 111(d) rules. These forecasts begin with

the Company's base September 30, 2014 official forward price curve.

Nominal Average Annual Henry Hub Gas Prices

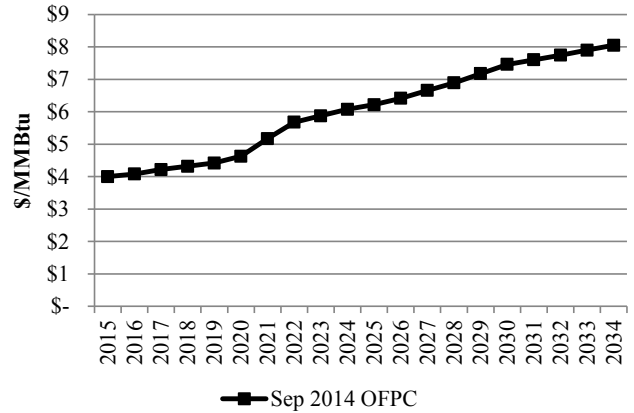

Nominal Average Annual Power Prices (Flat)

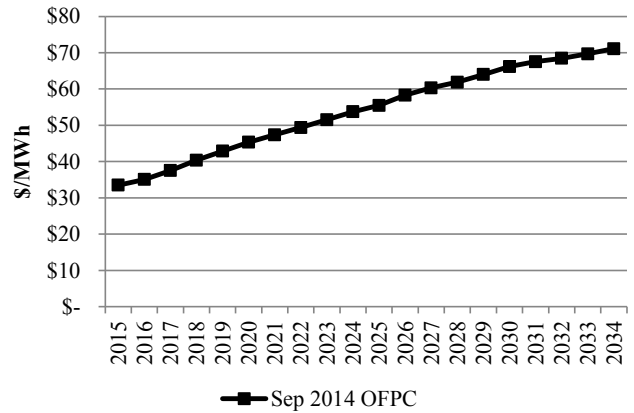

Regional Haze

Sensitivity S-10 reflects Regional Haze Scenario 3 which is an alternative to Regional Haze Scenarios 1 and 2, which assumes inter-temporal and fleet trade-off Regional Haze compliance outcomes as shown in the table below. This scenario is for planning purposes recognizing that agency, regulator, and joint owner perspectives on acceptability have not been determined.

Coal Unit	Description
Carbon 1	Shut Down Apr 2015
Carbon 2	Shut Down Apr 2015
Cholla 4	Conversion by Jun 2025
Colstrip 3	SCR by Dec 2023
Colstrip 4	SCR by Dec 2022
Craig 1	SCR by Aug 2021
Craig 2	SCR by Jan 2018
Dave Johnson 1	Shut Down Dec 2027
Dave Johnson 2	Shut Down Dec 2027
Dave Johnson 3	Shut Down Dec 2027
Dave Johnson 4	Shut Down Dec 2027
Hayden 1	SCR by Jun 2015
Hayden 2	SCR by Jun 2016
Hunter 1	SCR by Dec 2021

Sensitivity: S-10 (Separate East/West BAAs)

Hunter 2	Shut Down Dec 2032
Hunter 3	SCR by Dec 2024
Huntington 1	SCR by Dec 2022
Huntington 2	Shut Down by Dec 2029
Jim Bridger 1	SCR by Dec 2022
Jim Bridger 2	SCR by Dec 2021
Jim Bridger 3	SCR by Dec 2015
Jim Bridger 4	SCR by Dec 2016
Naughton 1	Shut Down by Dec 2029
Naughton 2	Shut Down by Dec 2029
Naughton 3	Conversion by Jun 2018; Shut Down by Dec 2029
Wyodak	Shut Down by Dec 2039

SCR = selective catalytic reduction

Federal Tax Incentives

- PTCs expire end of 2013
- ITC of 30% expire end of 2016, thereafter it continues in perpetuity at 10%.

Load Forecast

The medium load forecast will be used. The figure below shows the system coincident peak load forecast before accounting for any potential contribution from DSM or distributed generation resources.

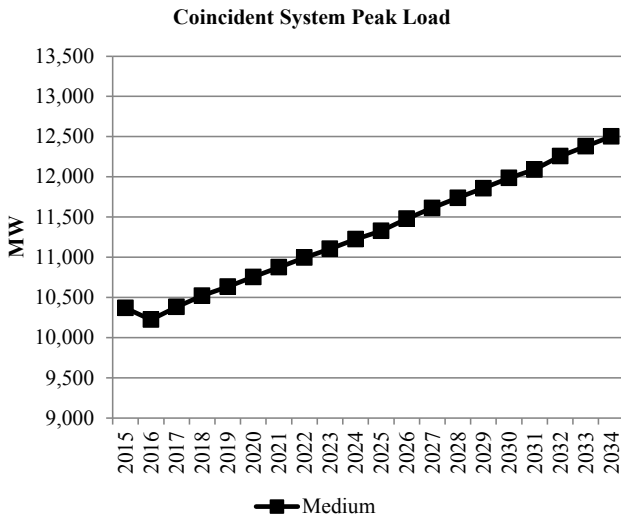

Energy Efficiency (Class 2 DSM)

Base case supply curves and ramp rates with resource selections up to the achievable potential. Class 2 resources that are not selected in any given year are not available for selection in future years. Achievable potential by state and year are summarized below.

Class 2 DSM Cumulative Achievable Potential

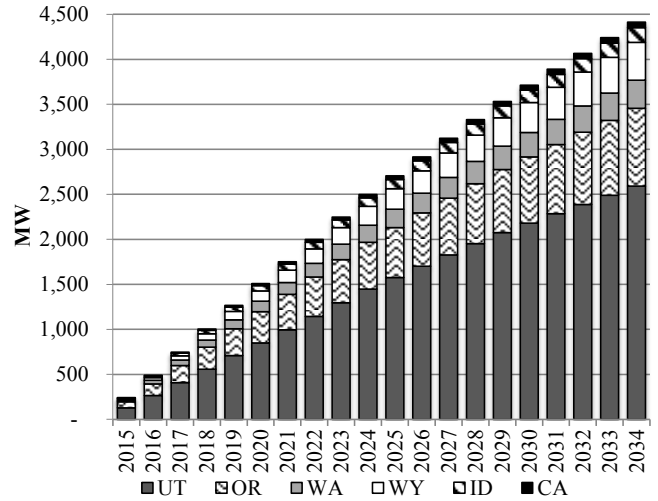

Distributed Generation

Base case distributed generation penetration is assumed in all states. Distributed generation by state and year are summarized below.

Distributed Generation - Base Penetration Case

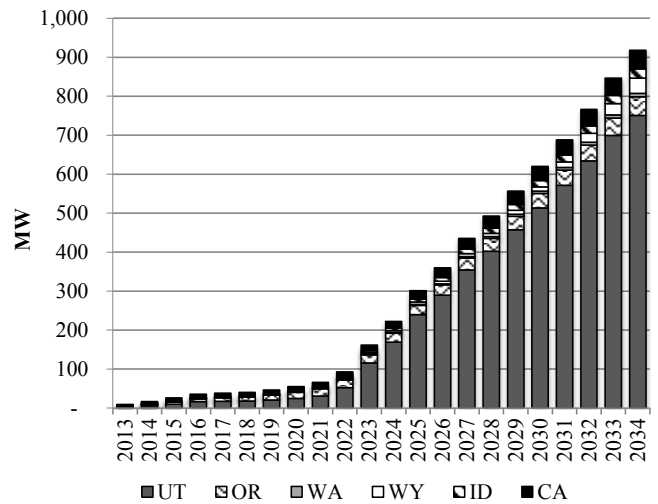

PORTFOLIO SUMMARY

System Optimizer PVRR (\$m)

Cost	East BAA	West BAA	East/West Total	System Benchmark
System Cost w/o Transmission Upgrades				
Transmission Integration	\$19,377	\$8,096	\$27,473	\$26,460
Transmission Reinforcement	\$289	\$33	\$322	\$14
Total Cost	\$6	\$0	\$6	\$6
Total Cost	\$19,672	\$8,129	\$27,801	\$26,480

Sensitivity: S-10 (Separate East/West BAAs)

Resource Portfolio

Cumulative changes to the resource portfolio (new resource additions and resource retirements), represented as nameplate capacity, are summarized in the figures below. Figures are included for the East and West as stand-alone BAAs, and the benchmark system portfolio.

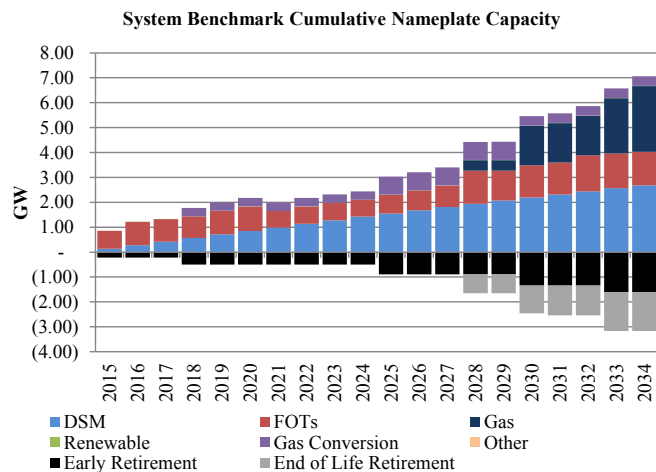
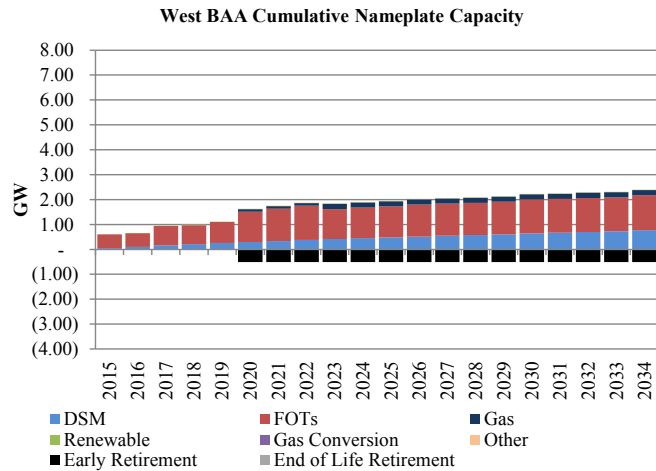
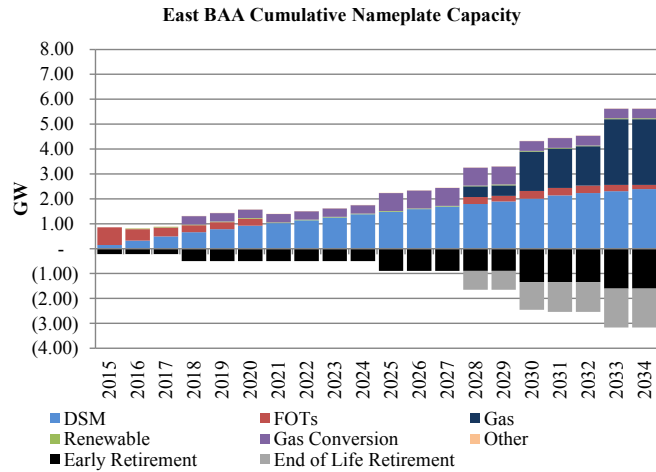

System CO₂ Emissions (System Optimizer)

System CO₂ emissions from System Optimizer are shown for the separate BAAs alongside those for the Benchmark System, and Case C05-3 in the figure below.

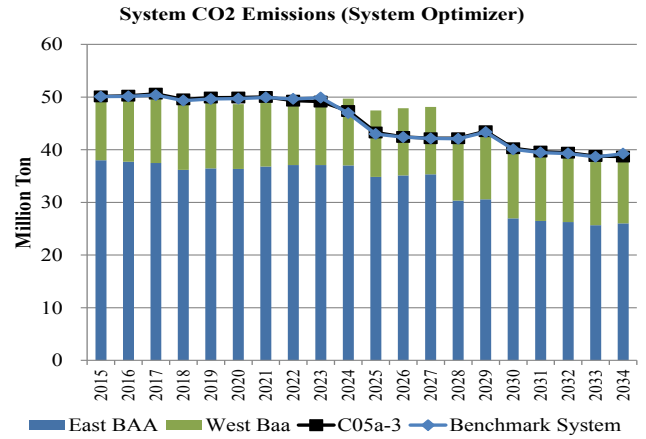

111(d) Compliance Profiles

The following figures summarize how compliance with state emission rate goals is achieved. The sum of each stacked bar represents the fossil emission rate. The net final rate represents the fossil rate after accounting for the emission rate impacts of new thermal (new NGCC units or nuclear, as applicable), re-dispatch of fossil units, energy efficiency (EE), and allocated renewable energy (RE).

East BAA

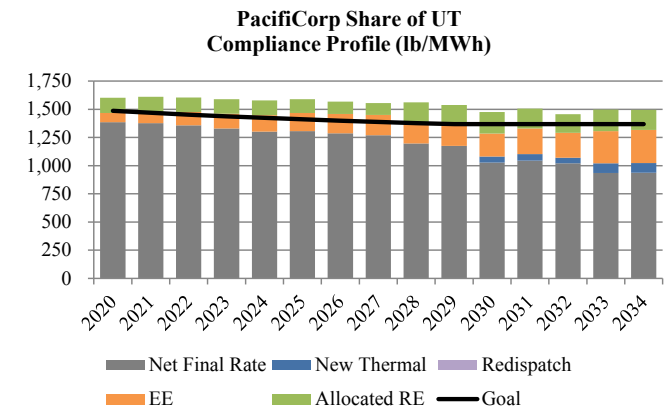
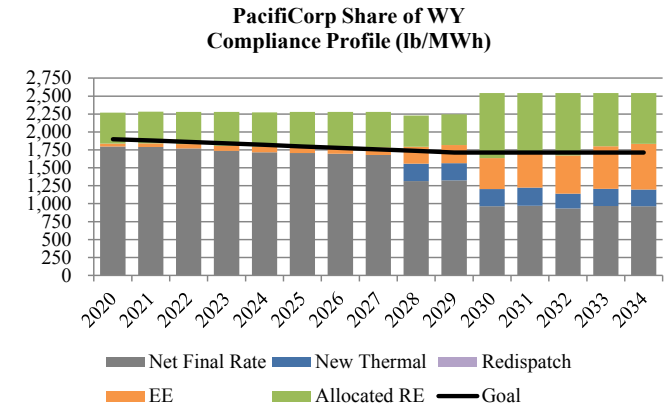

Sensitivity: S-10 (Separate East/West BAAs)

West BAA

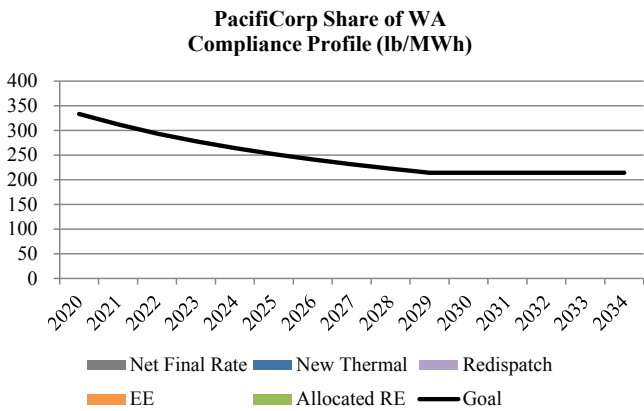
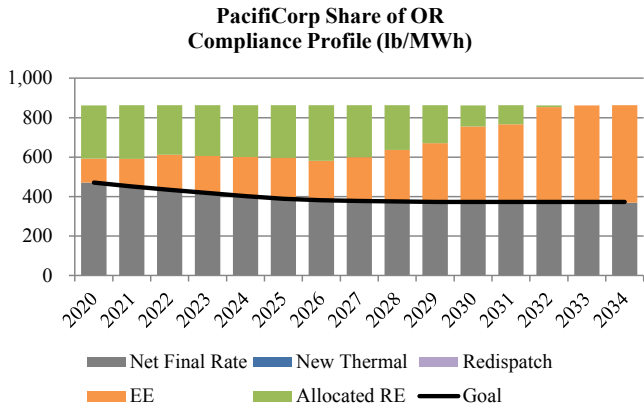

Benchmark System

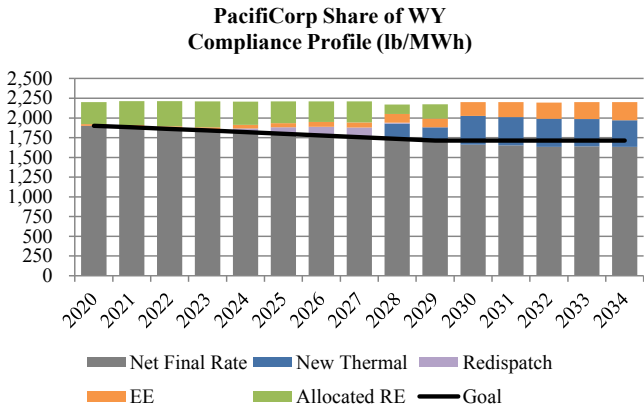

PacifiCorp Share of UT Compliance Profile (lb/MWh)

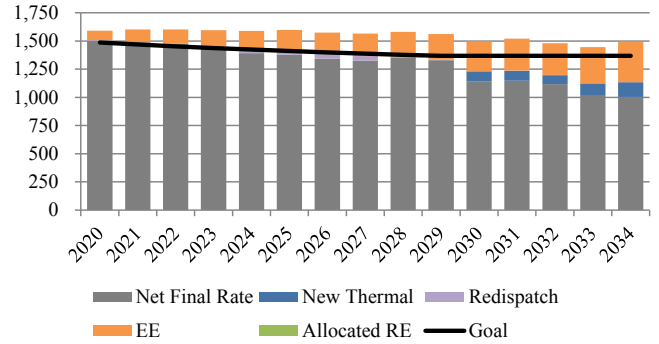

PacifiCorp Share of OR Compliance Profile (lb/MWh)

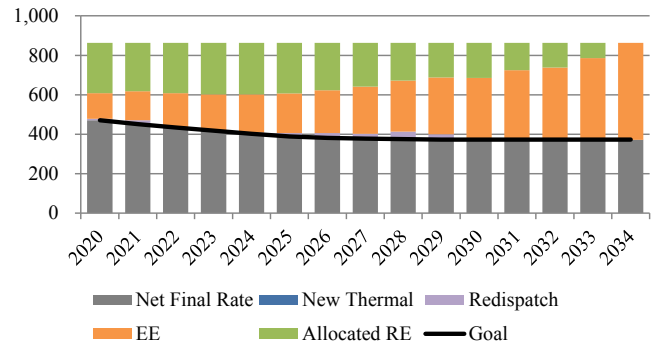

PacifiCorp Share of WA Compliance Profile (lb/MWh)

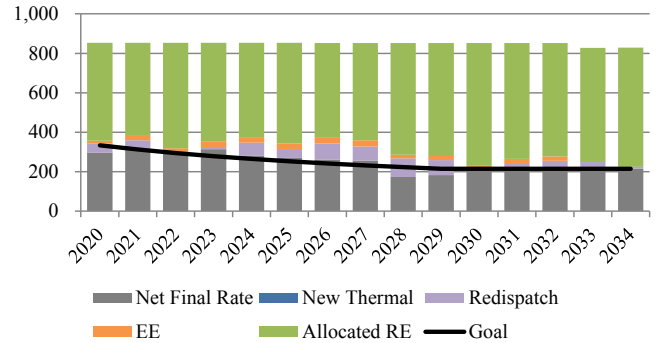

Sensitivity: S-11 (111(d) and High CO2 Prices)

CASE ASSUMPTIONS

Description

Sensitivity S-11 produces a portfolio that meets PacifiCorp’s share of state 111(d) emission rate goals in all states in which PacifiCorp has fossil generation and retail customers. This case also includes a CO2 price signal beginning 2020 at approximately \$22/ton rising to nearly \$162/ton by 2034. For 111(d) compliance purposes, the compliance strategy applied to this case relies on flexible allocation of renewable energy and energy efficiency while prioritizing re-dispatch of fossil generation to achieve incremental emission rate reductions as required. For planning purposes, this case assumes Regional Haze Scenario 1 compliance reflecting potential inter-temporal and fleet trade-off compliance outcomes. This sensitivity is a variant of Core Case C14-1.

Federal CO2 Policy/Price Signal

Sensitivity S-11 reflects EPA’s proposed 111(d) rule with an additional CO2 price signal. The table below summarizes the interim emission rate goal and the final emission rate target by state assumed to apply to PacifiCorp’s system.

State	Interim Goal (Avg. 2020-2029) (lb/MWh)	Final Target (2030 & Beyond) (lb/MWh)
WY	1,808	1,714
UT*	1,378	1,322
OR	407	372
WA	264	215

*EPA’s calculation of the target for UT treated PacifiCorp’s Lakeside 2 NGCC plant as an existing resource. The emission rate assumed for UT assumes Lake Side 2 is correctly classified as “under construction”.

The 111(d) compliance strategy implemented for this case is summarized as follows:

- Flexible allocation of system renewable resources and flexible allocation of cumulative energy efficiency savings beginning 2017 from ID and CA, where PacifiCorp does not own fossil generation.
- Cumulative cost-effective selection of energy efficiency beginning 2017.
- New NGCC generation in WY and UT (new NGCC resources are not allowed in OR, WA, and ID).
- Re-dispatch of existing fossil generation, as required.
- Addition of new renewable resources, as required.

Forward Price Curve

Sensitivity S-11 gas and power prices will utilize medium natural gas and high CO2 price assumptions. The graphs below summarize S-11 gas and power prices alongside those using medium natural gas prices as well as the electricity market price impacts of EPA’s proposed 111(d) rules.

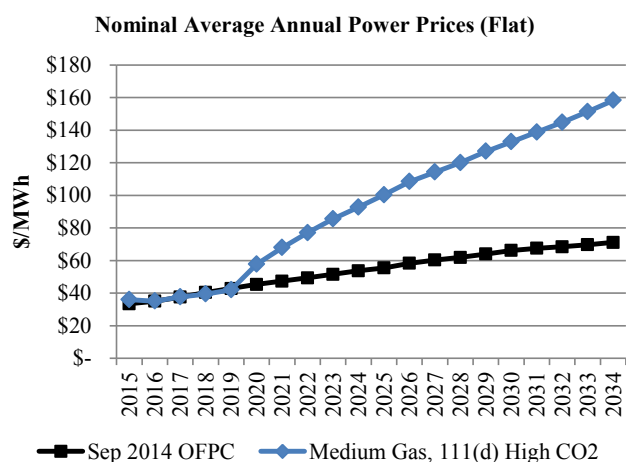
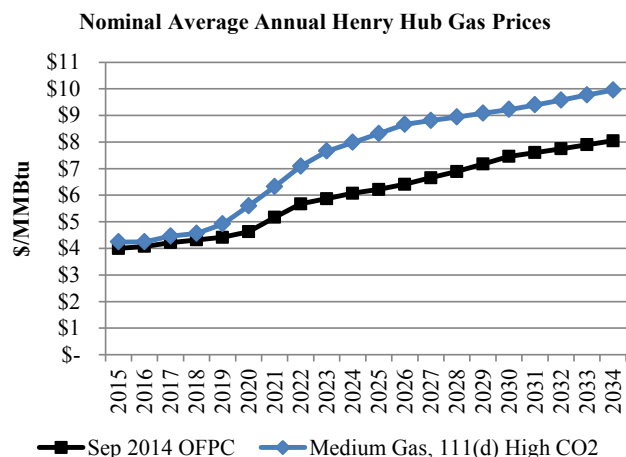

Federal CO2 Policy/Price Signal

Sensitivity S-11 includes high CO2 prices starting in 2020 at \$22.39/ton rising to nearly \$162/ton by 2034.

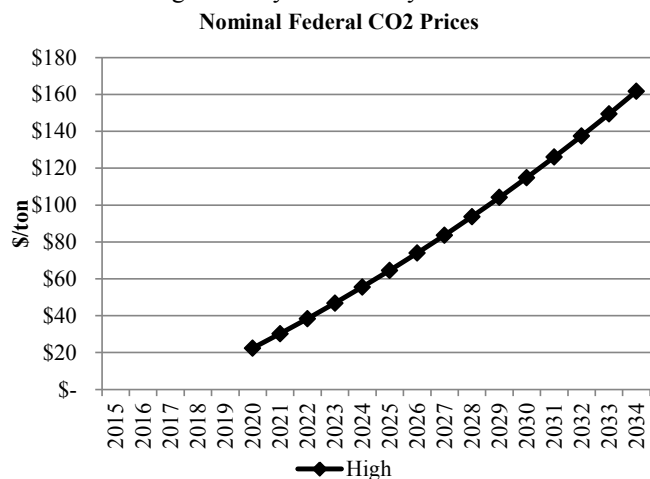

Regional Haze

Sensitivity S-11 reflects Regional Haze Scenario 1, which assumes inter-temporal and fleet trade-off Regional Haze compliance outcomes as shown in the table below. This scenario is for planning purposes recognizing that agency, Sensitivity S-11

Sensitivity: S-11 (111(d) and High CO2 Prices)

regulator, and joint owner perspectives on acceptability have not been determined.

Coal Unit	Description
Carbon 1	Shut Down Apr 2015
Carbon 2	Shut Down Apr 2015
Cholla 4	Conversion by Jun 2025
Colstrip 3	SCR by Dec 2023
Colstrip 4	SCR by Dec 2022
Craig 1	SCR by Aug 2021
Craig 2	SCR by Jan 2018
Dave Johnston 1	Shut Down Mar 2019
Dave Johnston 2	Shut Down Dec 2027
Dave Johnston 3	Shut Down Dec 2027
Dave Johnston 4	Shut Down Dec 2032
Hayden 1	SCR by Jun 2015
Hayden 2	SCR by Jun 2016
Hunter 1	SCR by Dec 2021
Hunter 2	Shut Down by Dec 2032
Hunter 3	SCR by Dec 2024
Huntington 1	Shut Down by Dec 2036
Huntington 2	Shut Down by Dec 2021
Jim Bridger 1	Shut Down by Dec 2023
Jim Bridger 2	Shut Down by Dec 2032
Jim Bridger 3	SCR by Dec 2015
Jim Bridger 4	SCR by Dec 2016
Naughton 1	Shut Down by Dec 2029
Naughton 2	Shut Down by Dec 2029
Naughton 3	Conversion by Jun 2018; Shut Down by Dec 2029
Wyodak	Shut Down by Dec 2039

SCR = selective catalytic reduction

Federal Tax Incentives

- PTCs expire end of 2013
- ITC of 30% expire end of 2016, thereafter it continues in perpetuity at 10%.

Load Forecast

The medium load forecast will be used. The figure below shows the system coincident peak load forecast before accounting for any potential contribution from DSM or distributed generation resources.

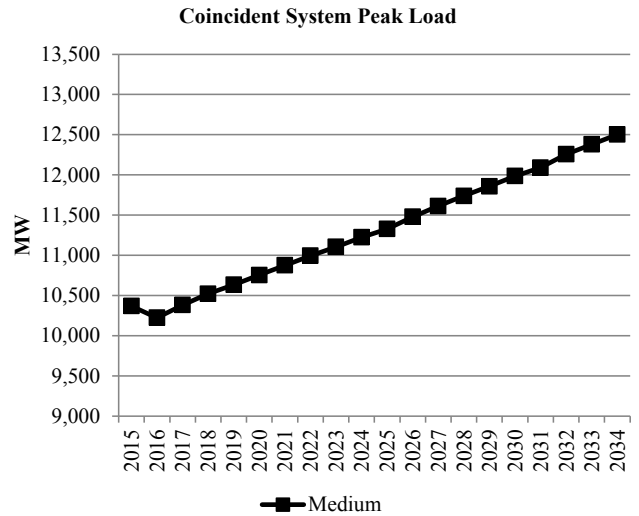

Energy Efficiency (Class 2 DSM)

Base case supply curves and ramp rates with resource selections up to the achievable potential. Class 2 resources that are not selected in any given year are not available for selection in future years. Achievable potential by state and year are summarized below.

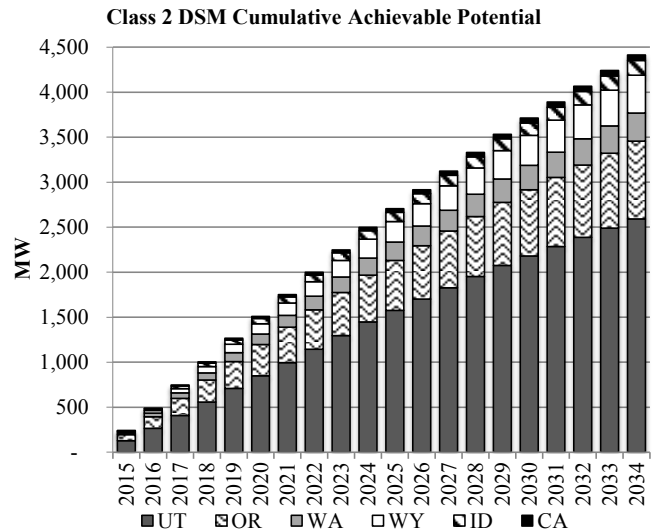

Distributed Generation

Base case distributed generation penetration is assumed in all states. Distributed generation by state and year are summarized below.

Sensitivity: S-11 (111(d) and High CO2 Prices)

Distributed Generation - Base PenetrationCase

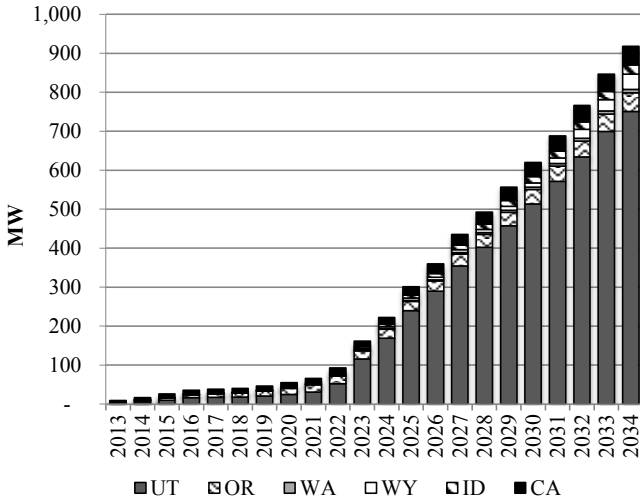

System CO2 Emissions (System Optimizer)

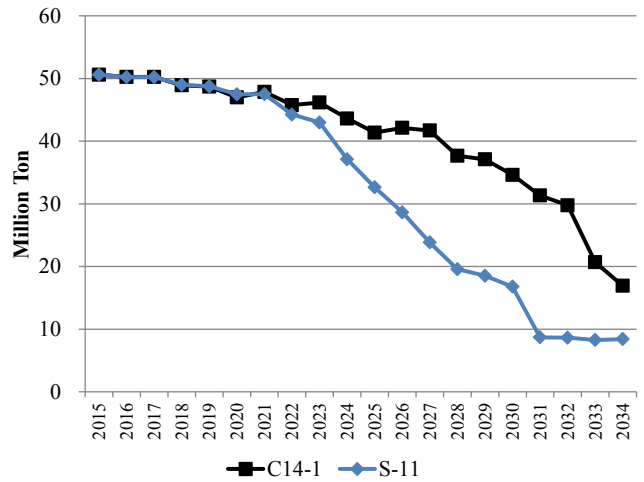

PORTFOLIO SUMMARY

System Optimizer PVRR (\$m)

System Cost without Transmission Upgrades	\$44,629
Transmission Integration	\$455
Transmission Reinforcement	\$7
Total Cost	\$45,091

Resource Portfolio

Cumulative changes to the resource portfolio (new resource additions and resource retirements), represented as nameplate capacity, are summarized in the figure below.

Cumulative Nameplate Capacity

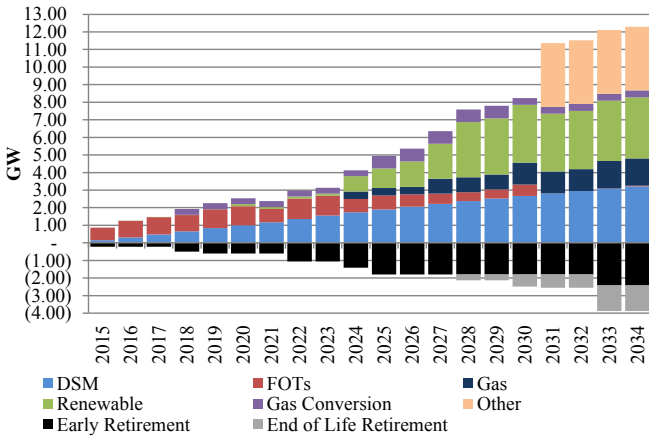

111(d) Compliance Profiles

The following figures summarize how compliance with state emission rate goals is achieved. The sum of each stacked bar represents the fossil emission rate. The net final rate represents the fossil rate after accounting for the emission rate impacts of new thermal (new NGCC units or nuclear, as applicable), re-dispatch of fossil units, energy efficiency (EE), and allocated renewable energy (RE).

PacifiCorp Share of WY Compliance Profile (lb/MWh)

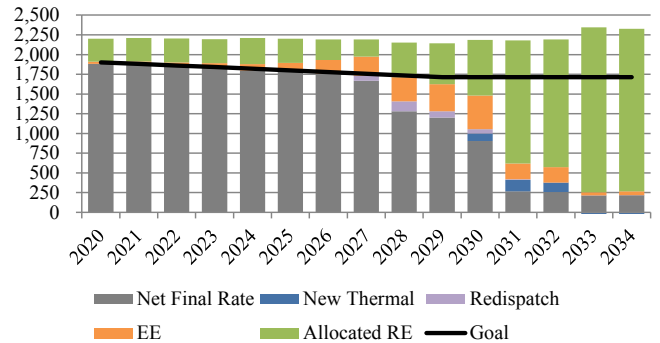

PacifiCorp Share of UT Compliance Profile (lb/MWh)

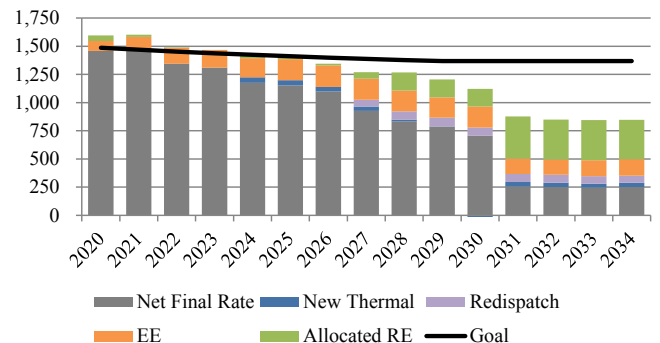

System CO2 Emissions (System Optimizer)

System CO₂ emissions from System Optimizer are shown alongside those from Cases C14-1 and S-11 in the figure below.

Sensitivity: S-11 (111(d) and High CO2 Prices)

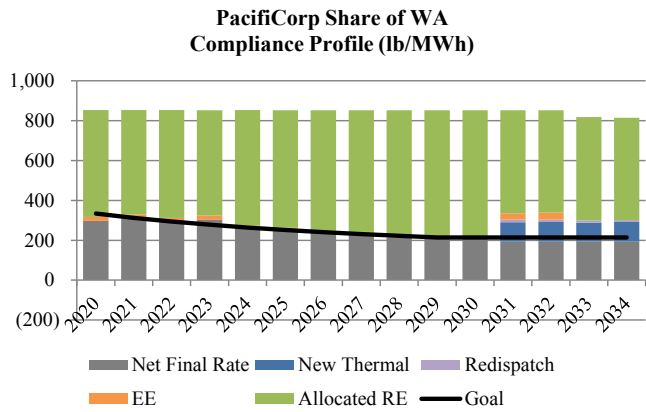
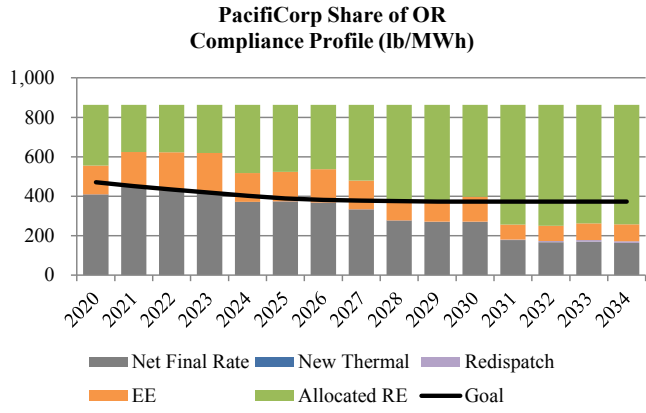

Sensitivity: S-12 (Stakeholder Solar Cost Assumptions)

CASE ASSUMPTIONS

Description

Sensitivity S-12 is based on recommendations from stakeholders. This sensitivity assumes that the costs of solar resources decrease linearly on real basis through the 20-year IRP study period, consistent with a “learning curve” approach. S-12 also assumes a high penetration of DG in line with the solar cost assumptions. As with the other cases this one produced a portfolio that meets PacifiCorp’s share of state 111(d) emission rate goals in all states in which PacifiCorp has fossil generation and retail customers. The compliance strategy applied to this case relies on flexible allocation of renewable energy and energy efficiency while prioritizing re-dispatch of fossil generation to achieve incremental emission rate reductions as required. For planning purposes, this case assumes Regional Haze Scenario 1 reflecting potential inter-temporal and fleet trade-off compliance outcomes. This sensitivity is a variant of Core Case C05-1.

Federal CO₂ Policy/Price Signal

Sensitivity S-12 reflects EPA’s proposed 111(d) rule with no additional CO₂ price signal. The table below summarizes the interim emission rate goal and the final emission rate target by state assumed to apply to PacifiCorp’s system.

State	Interim Goal (Avg. 2020-2029) (lb/MWh)	Final Target (2030 & Beyond) (lb/MWh)
WY	1,808	1,714
UT*	1,378	1,322
OR	407	372
WA	264	215

*EPA’s calculation of the target for UT treated PacifiCorp’s Lakeside 2 NGCC plant as an existing resource. The emission rate assumed for UT assumes Lake Side 2 is correctly classified as “under construction”.

The 111(d) compliance strategy implemented for this case is summarized as follows:

- Flexible allocation of system renewable resources and flexible allocation of cumulative energy efficiency savings beginning 2017 from ID and CA, where PacifiCorp does not own fossil generation.
- Cumulative cost-effective selection of energy efficiency beginning 2017.
- New NGCC generation in WY and UT (new NGCC resources are not allowed in OR, WA, and ID).
- Re-dispatch of existing fossil generation, as required.
- Addition of new renewable resources, as required.

Forward Price Curve

Sensitivity S-12 gas and power prices will utilize medium natural gas prices as well as market price impacts associated with EPA’s proposed 111(d) rules. These forecasts begin with the Company’s base September 30, 2014 official forward price curve.

February 26, 2015

Nominal Average Annual Henry Hub Gas Prices

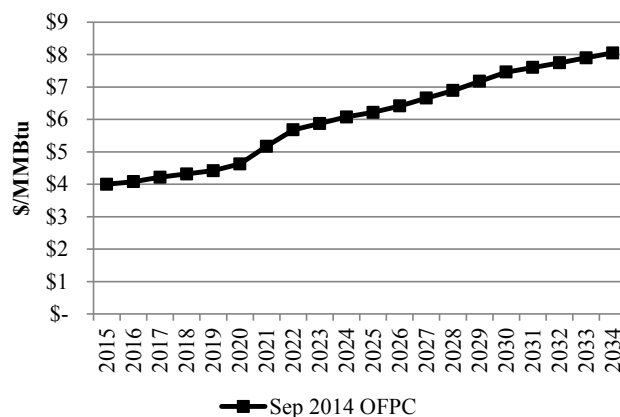

Nominal Average Annual Power Prices (Flat)

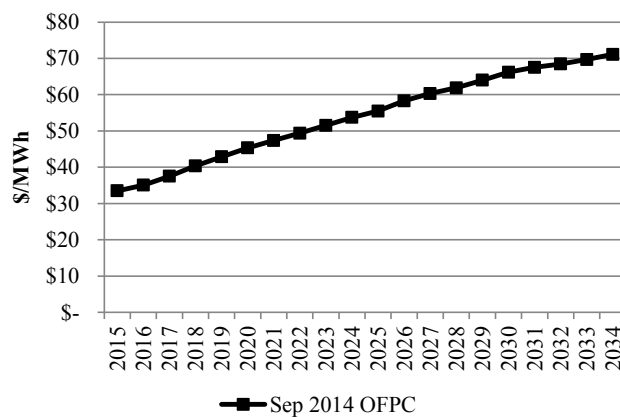

Regional Haze

Sensitivity S-12 reflects Regional Haze Scenario 1, which assumes inter-temporal and fleet trade-off Regional Haze compliance outcomes as shown in the table below. This scenario is for planning purposes recognizing that agency, regulator, and joint owner perspectives on acceptability have not been determined.

Coal Unit	Description
Carbon 1	Shut Down Apr 2015
Carbon 2	Shut Down Apr 2015
Cholla 4	Conversion by Jun 2025
Colstrip 3	SCR by Dec 2023
Colstrip 4	SCR by Dec 2022
Craig 1	SCR by Aug 2021
Craig 2	SCR by Jan 2018
Dave Johnston 1	Shut Down Mar 2019
Dave Johnston 2	Shut Down Dec 2027
Dave Johnston 3	Shut Down Dec 2027
Dave Johnston 4	Shut Down Dec 2032
Hayden 1	SCR by Jun 2015
Hayden 2	SCR by Jun 2016
Hunter 1	SCR by Dec 2021
Hunter 2	Shut Down by Dec 2032
Hunter 3	SCR by Dec 2024
Huntington 1	Shut Down by Dec 2036

Sensitivity: S-12 (Stakeholder Solar Cost Assumptions)

Huntington 2	Shut Down by Dec 2021
Jim Bridger 1	Shut Down by Dec 2023
Jim Bridger 2	Shut Down by Dec 2032
Jim Bridger 3	SCR by Dec 2015
Jim Bridger 4	SCR by Dec 2016
Naughton 1	Shut Down by Dec 2029
Naughton 2	Shut Down by Dec 2029
Naughton 3	Conversion by Jun 2018; Shut Down by Dec 2029
Wyodak	Shut Down by Dec 2039

SCR = selective catalytic reduction

Federal Tax Incentives

- PTCs expire end of 2013
- ITC of 30% expire end of 2016, thereafter it continues in perpetuity at 10%.

Load Forecast

The medium load forecast will be used. The figure below shows the system coincident peak load forecast before accounting for any potential contribution from DSM or distributed generation resources.

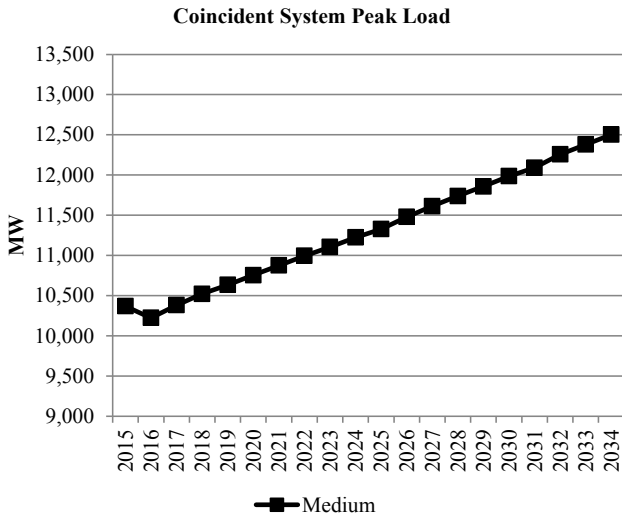

Energy Efficiency (Class 2 DSM)

Base case supply curves and ramp rates with resource selections up to the achievable potential. Class 2 resources that are not selected in any given year are not available for selection in future years. Achievable potential by state and year are summarized below.

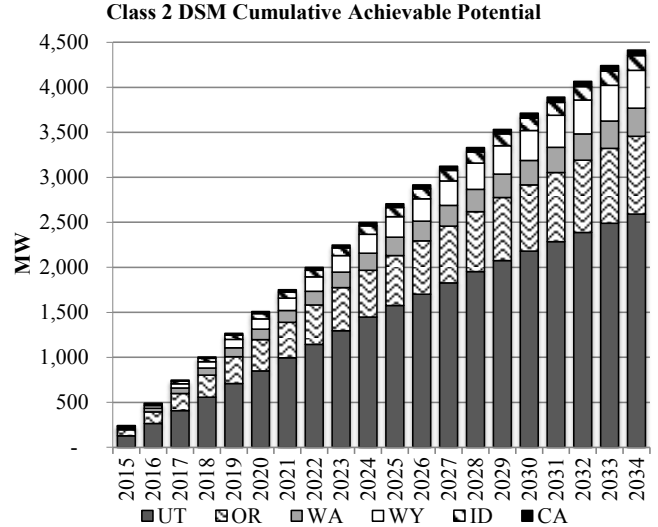

Distributed Generation

High distributed generation penetration is assumed in all states. Distributed generation by state and year are summarized below.

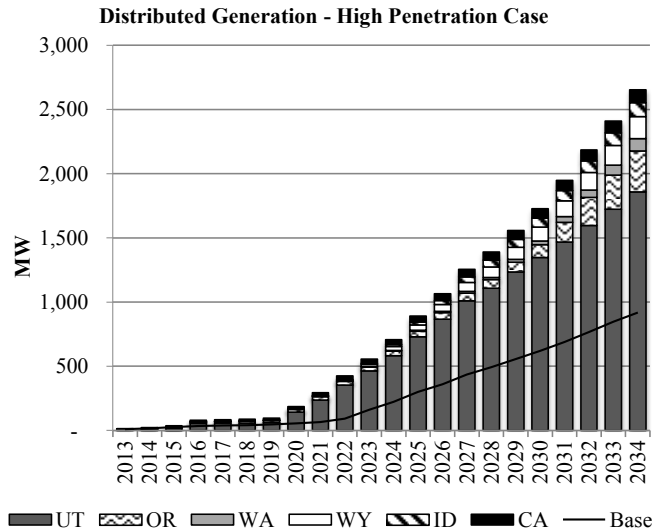

PORTFOLIO SUMMARY

System Optimizer PVRR (\$/m)

System Cost without Transmission Upgrades	\$25,993
Transmission Integration	\$31
Transmission Reinforcement	\$6
Total Cost	\$26,029

Sensitivity: S-12 (Stakeholder Solar Cost Assumptions)

Resource Portfolio

Cumulative changes to the resource portfolio (new resource additions and resource retirements), represented as nameplate capacity, are summarized in the figure below.

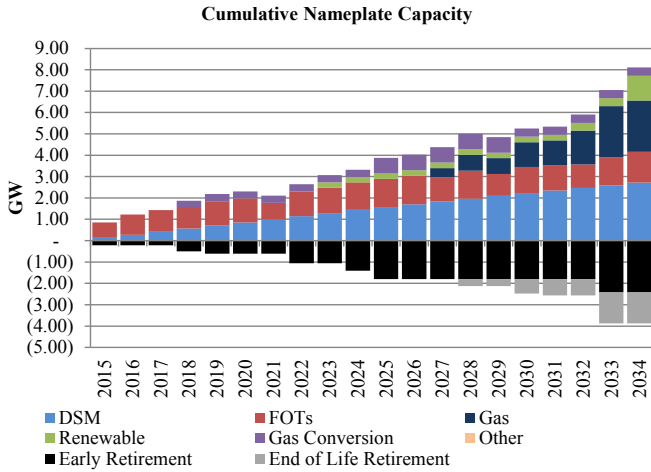

System CO₂ Emissions (System Optimizer)

System CO₂ emissions from System Optimizer are shown alongside those from Cases C05-1 and S-12 in the figure below.

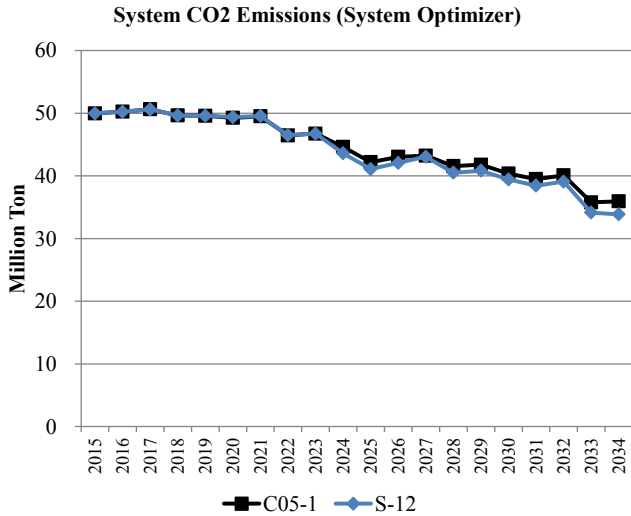

111(d) Compliance Profiles

The following figures summarize how compliance with state emission rate goals is achieved. The sum of each stacked bar represents the fossil emission rate. The net final rate represents the fossil rate after accounting for the emission rate impacts of new thermal (new NGCC units or nuclear, as applicable), re-dispatch of fossil units, energy efficiency (EE), and allocated renewable energy (RE).

PacifiCorp Share of Wyoming Compliance Path (lb/MWh)

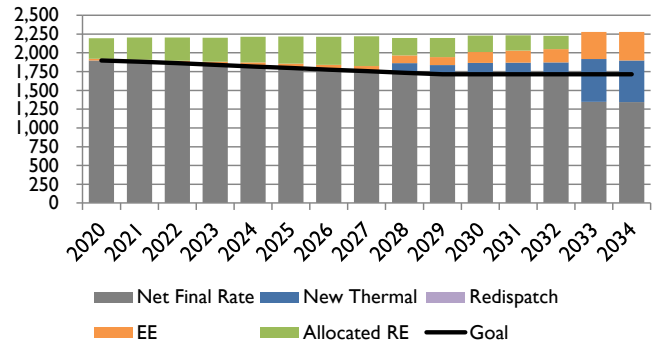

PacifiCorp Share of Utah Compliance Path (lb/MWh)

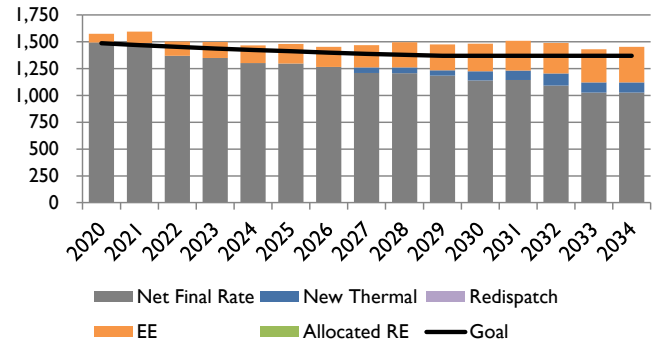

PacifiCorp Share of Oregon Compliance Path (lb/MWh)

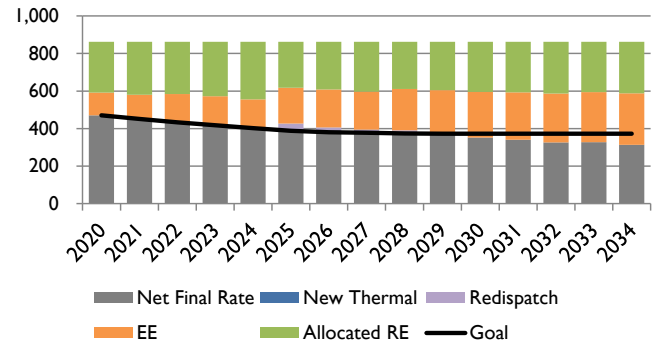

PacifiCorp Share of Washington Compliance Path (lb/MWh)

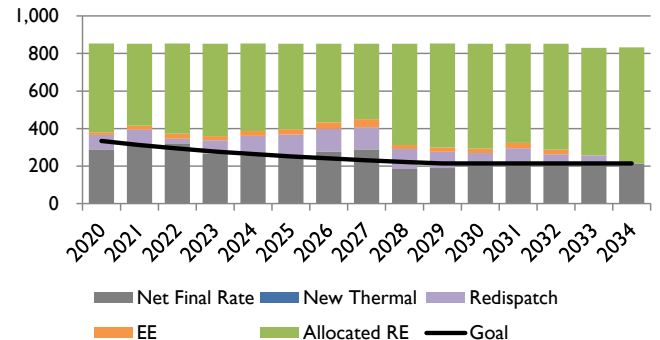

Sensitivity: S-13 (Compressed Air Storage)

CASE ASSUMPTIONS

Description

Sensitivity S-13 assumes construction of a 300 MW compressed air energy storage facility on the Company’s east side. This facility replaced the need for a 423 MW CCT in 2024. As with the other cases this one produced a portfolio that meets PacifiCorp’s share of state 111(d) emission rate goals in all states in which PacifiCorp has fossil generation and retail customers. The compliance strategy applied to this case relies on flexible allocation of renewable energy and energy efficiency while prioritizing re-dispatch of fossil generation to achieve incremental emission rate reductions as required. For planning purposes, this case assumes Regional Haze Scenario 1 reflecting potential inter-temporal and fleet trade-off compliance outcomes. This sensitivity is a variant of Core Case C05-1.

Federal CO₂ Policy/Price Signal

Sensitivity S-13 reflects EPA’s proposed 111(d) rule with no additional CO₂ price signal. The table below summarizes the interim emission rate goal and the final emission rate target by state assumed to apply to PacifiCorp’s system.

State	Interim Goal (Avg. 2020-2029) (lb/MWh)	Final Target (2030 & Beyond) (lb/MWh)
WY	1,808	1,714
UT*	1,378	1,322
OR	407	372
WA	264	215

*EPA’s calculation of the target for UT treated PacifiCorp’s Lakeside 2 NGCC plant as an existing resource. The emission rate assumed for UT assumes Lake Side 2 is correctly classified as “under construction”.

The 111(d) compliance strategy implemented for this case is summarized as follows:

- Flexible allocation of system renewable resources and flexible allocation of cumulative energy efficiency savings beginning 2017 from ID and CA, where PacifiCorp does not own fossil generation.
- Cumulative cost-effective selection of energy efficiency beginning 2017.
- New NGCC generation in WY and UT (new NGCC resources are not allowed in OR, WA, and ID).
- Re-dispatch of existing fossil generation, as required.
- Addition of new renewable resources, as required.

Forward Price Curve

Sensitivity S-13 gas and power prices will utilize medium natural gas prices as well as market price impacts associated with EPA’s proposed 111(d) rules. These forecasts begin with the Company’s base September 30, 2014 official forward price curve.

Nominal Average Annual Henry Hub Gas Prices

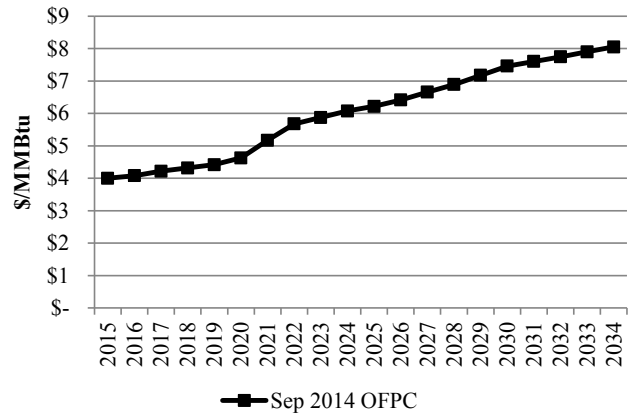

Nominal Average Annual Power Prices (Flat)

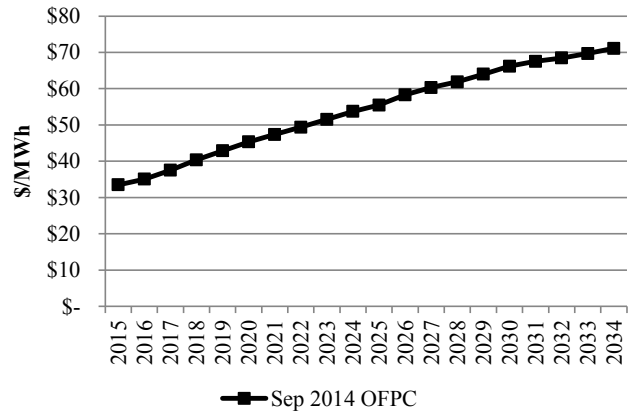

Regional Haze

Sensitivity S-13 reflects Regional Haze Scenario 1, which assumes inter-temporal and fleet trade-off Regional Haze compliance outcomes as shown in the table below. This scenario is for planning purposes recognizing that agency, regulator, and joint owner perspectives on acceptability have not been determined.

Coal Unit	Description
Carbon 1	Shut Down Apr 2015
Carbon 2	Shut Down Apr 2015
Cholla 4	Conversion by Jun 2025
Colstrip 3	SCR by Dec 2023
Colstrip 4	SCR by Dec 2022
Craig 1	SCR by Aug 2021
Craig 2	SCR by Jan 2018
Dave Johnston 1	Shut Down Mar 2019
Dave Johnston 2	Shut Down Dec 2027
Dave Johnston 3	Shut Down Dec 2027
Dave Johnston 4	Shut Down Dec 2032
Hayden 1	SCR by Jun 2015
Hayden 2	SCR by Jun 2016
Hunter 1	SCR by Dec 2021
Hunter 2	Shut Down by Dec 2032
Hunter 3	SCR by Dec 2024
Huntington 1	Shut Down by Dec 2036

Sensitivity: S-13 (Compressed Air Storage)

Huntington 2	Shut Down by Dec 2021
Jim Bridger 1	Shut Down by Dec 2023
Jim Bridger 2	Shut Down by Dec 2032
Jim Bridger 3	SCR by Dec 2015
Jim Bridger 4	SCR by Dec 2016
Naughton 1	Shut Down by Dec 2029
Naughton 2	Shut Down by Dec 2029
Naughton 3	Conversion by Jun 2018; Shut Down by Dec 2029
Wyodak	Shut Down by Dec 2039

SCR = selective catalytic reduction

Federal Tax Incentives

- PTCs expire end of 2013
- ITC of 30% expire end of 2016, thereafter it continues in perpetuity at 10%.

Load Forecast

The medium load forecast will be used. The figure below shows the system coincident peak load forecast before accounting for any potential contribution from DSM or distributed generation resources.

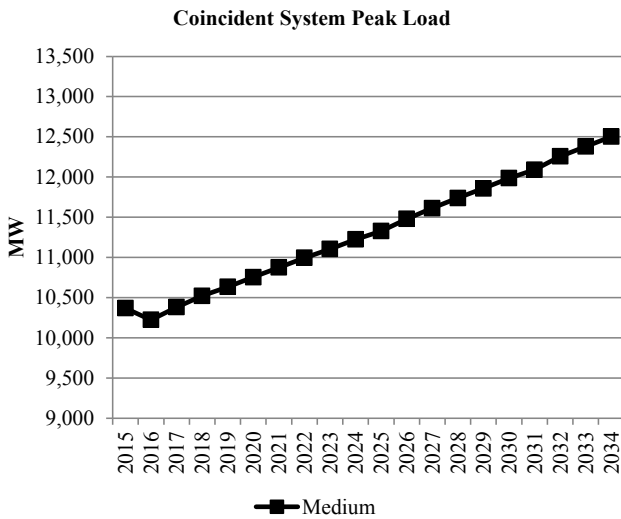

Energy Efficiency (Class 2 DSM)

Base case supply curves and ramp rates with resource selections up to the achievable potential. Class 2 resources that are not selected in any given year are not available for selection in future years. Achievable potential by state and year are summarized below.

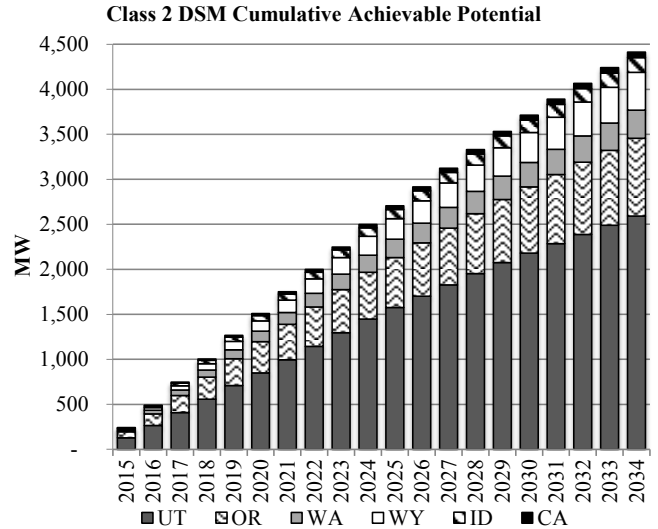

Distributed Generation

Base case distributed generation penetration is assumed in all states. Distributed generation by state and year are summarized below.

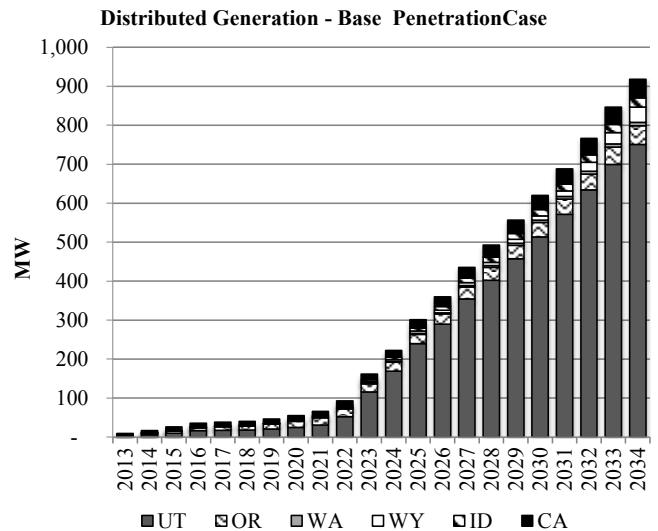

PORTFOLIO SUMMARY

System Optimizer PVRR (\$m)

System Cost without Transmission Upgrades	\$26,950
Transmission Integration	\$90
Transmission Reinforcement	\$6
Total Cost	\$27,046

Sensitivity: S-13 (Compressed Air Storage)

Resource Portfolio

Cumulative changes to the resource portfolio (new resource additions and resource retirements), represented as nameplate capacity, are summarized in the figure below.

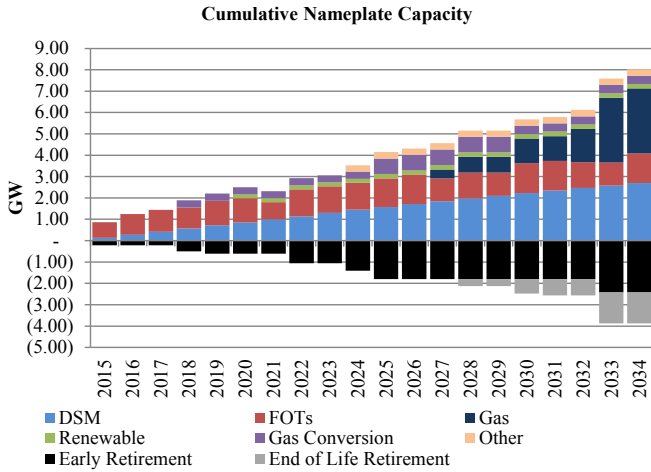

System CO₂ Emissions (System Optimizer)

System CO₂ emissions from System Optimizer are shown alongside those from Cases C05-1 and S-13 in the figure below.

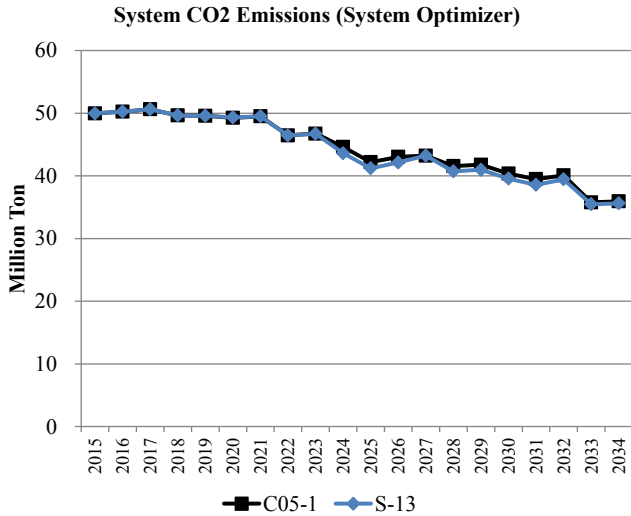

111(d) Compliance Profiles

The following figures summarize how compliance with state emission rate goals is achieved. The sum of each stacked bar represents the fossil emission rate. The net final rate represents the fossil rate after accounting for the emission rate impacts of new thermal (new NGCC units or nuclear, as applicable), re-dispatch of fossil units, energy efficiency (EE), and allocated renewable energy (RE).

PacifiCorp Share of Wyoming Compliance Path (lb/MWh)

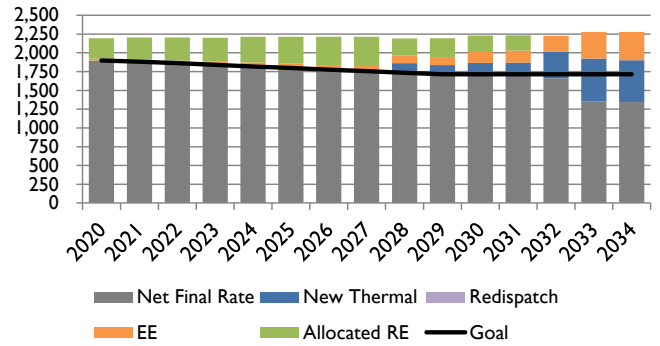

PacifiCorp Share of Utah Compliance Path (lb/MWh)

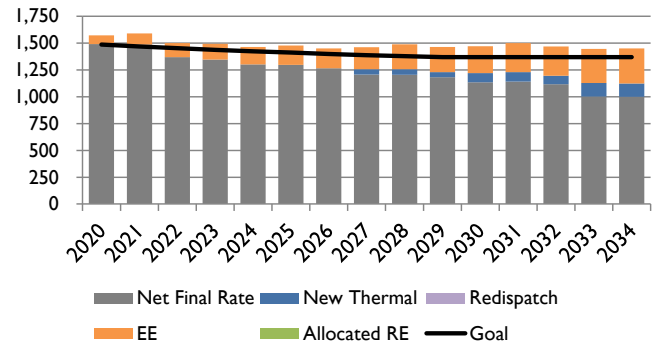

PacifiCorp Share of Oregon Compliance Path (lb/MWh)

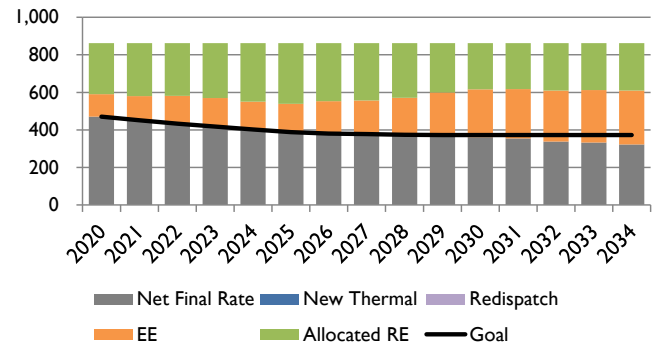

PacifiCorp Share of Washington Compliance Path (lb/MWh)

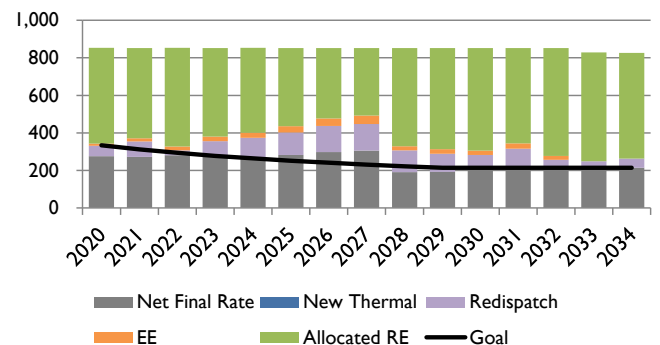

Sensitivity: S-14 (Class 3 DSM)

CASE ASSUMPTIONS

Description

Sensitivity S-14 incorporates Class 3 DSM resource alternatives. As with the other cases this one produced a portfolio that meets PacifiCorp’s share of state 111(d) emission rate goals in all states in which PacifiCorp has fossil generation and retail customers. The compliance strategy applied to this case relies on flexible allocation of renewable energy and energy efficiency while prioritizing re-dispatch of fossil generation to achieve incremental emission rate reductions as required. For planning purposes, this case assumes Regional Haze Scenario 1 reflecting potential inter-temporal and fleet trade-off compliance outcomes. This sensitivity is a variant of Core Case C05-1.

Federal CO₂ Policy/Price Signal

Sensitivity S-14 reflects EPA’s proposed 111(d) rule with no additional CO₂ price signal. The table below summarizes the interim emission rate goal and the final emission rate target by state assumed to apply to PacifiCorp’s system.

State	Interim Goal (Avg. 2020-2029) (lb/MWh)	Final Target (2030 & Beyond) (lb/MWh)
WY	1,808	1,714
UT*	1,378	1,322
OR	407	372
WA	264	215

*EPA’s calculation of the target for UT treated PacifiCorp’s Lakeside 2 NGCC plant as an existing resource. The emission rate assumed for UT assumes Lake Side 2 is correctly classified as “under construction”.

The 111(d) compliance strategy implemented for this case is summarized as follows:

- Flexible allocation of system renewable resources and flexible allocation of cumulative energy efficiency savings beginning 2017 from ID and CA, where PacifiCorp does not own fossil generation.
- Cumulative cost-effective selection of energy efficiency beginning 2017.
- New NGCC generation in WY and UT (new NGCC resources are not allowed in OR, WA, and ID).
- Re-dispatch of existing fossil generation, as required.
- Addition of new renewable resources, as required.

Forward Price Curve

Sensitivity S-14 gas and power prices will utilize medium natural gas prices as well as market price impacts associated with EPA’s proposed 111(d) rules. These forecasts begin with the Company’s base September 30, 2014 official forward price curve.

Nominal Average Annual Henry Hub Gas Prices

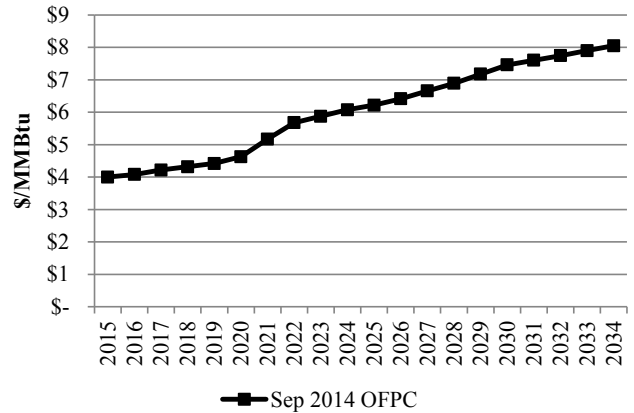

Nominal Average Annual Power Prices (Flat)

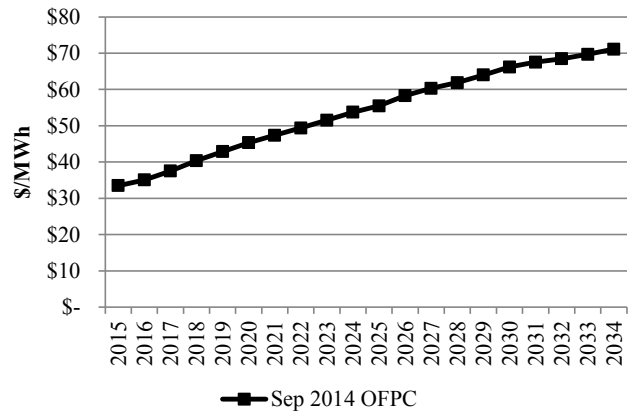

Regional Haze

Sensitivity S-14 reflects Regional Haze Scenario 1, which assumes inter-temporal and fleet trade-off Regional Haze compliance outcomes as shown in the table below. This scenario is for planning purposes recognizing that agency, regulator, and joint owner perspectives on acceptability have not been determined.

Coal Unit	Description
Carbon 1	Shut Down Apr 2015
Carbon 2	Shut Down Apr 2015
Cholla 4	Conversion by Jun 2025
Colstrip 3	SCR by Dec 2023
Colstrip 4	SCR by Dec 2022
Craig 1	SCR by Aug 2021
Craig 2	SCR by Jan 2018
Dave Johnston 1	Shut Down Mar 2019
Dave Johnston 2	Shut Down Dec 2027
Dave Johnston 3	Shut Down Dec 2027
Dave Johnston 4	Shut Down Dec 2032
Hayden 1	SCR by Jun 2015
Hayden 2	SCR by Jun 2016
Hunter 1	SCR by Dec 2021
Hunter 2	Shut Down by Dec 2032
Hunter 3	SCR by Dec 2024

Sensitivity: S-14 (Class 3 DSM)

Huntington 1	Shut Down by Dec 2036
Huntington 2	Shut Down by Dec 2021
Jim Bridger 1	Shut Down by Dec 2023
Jim Bridger 2	Shut Down by Dec 2032
Jim Bridger 3	SCR by Dec 2015
Jim Bridger 4	SCR by Dec 2016
Naughton 1	Shut Down by Dec 2029
Naughton 2	Shut Down by Dec 2029
Naughton 3	Conversion by Jun 2018; Shut Down by Dec 2029
Wyodak	Shut Down by Dec 2039

SCR = selective catalytic reduction

Federal Tax Incentives

- PTCs expire end of 2013
- ITC of 30% expire end of 2016, thereafter it continues in perpetuity at 10%.

Energy Efficiency (Class 2 DSM)

Base case supply curves and ramp rates with resource selections up to the achievable potential. Class 2 resources that are not selected in any given year are not available for selection in future years. Achievable potential by state and year are summarized below.

For this sensitivity, Class 3 DSM resources, which are generally considered non-firm due to the voluntary nature of customer response to price signals, will be considered firm resources. Only incremental potential is included in this sensitivity. To avoid overstating the capacity contribution of Class 3 DSM resources in this sensitivity, the potential for each Class 3 DSM product was adjusted for expected interactions among competing Class 1 and 3 DSM resource alternatives.

Load Forecast

The medium load forecast will be used. The figure below shows the system coincident peak load forecast before accounting for any potential contribution from DSM or distributed generation resources.

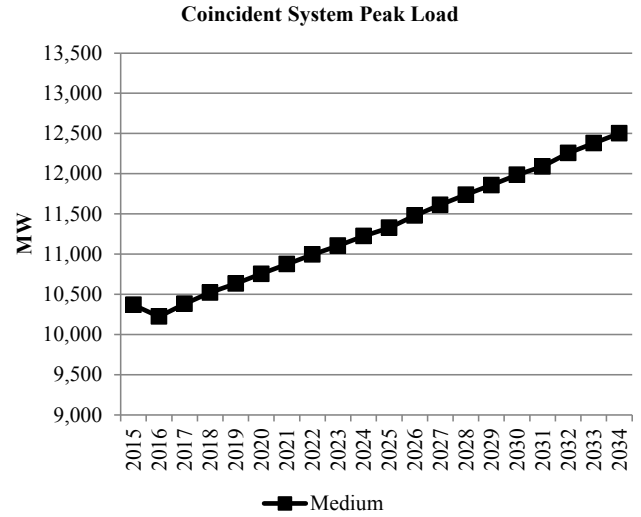

Energy Efficiency (Class 2 DSM)

Base case supply curves and ramp rates with resource selections up to the achievable potential. Class 2 resources that are not selected in any given year are not available for selection in future years. Achievable potential by state and year are summarized below.

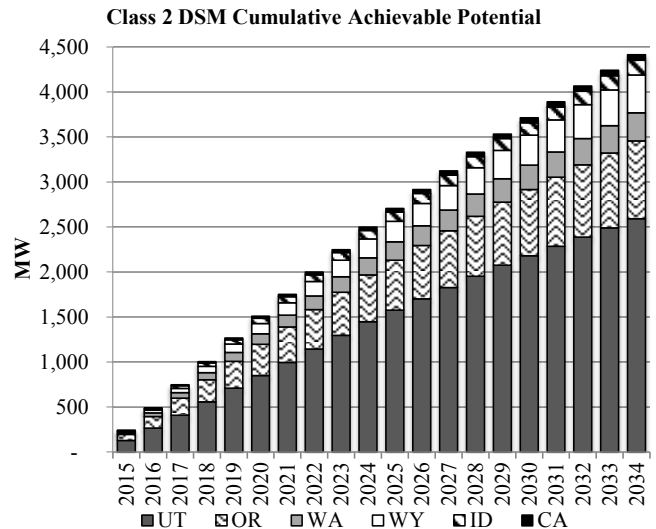

Distributed Generation

Base case distributed generation penetration is assumed in all states. Distributed generation by state and year are summarized below.

Sensitivity: S-14 (Class 3 DSM)

Distributed Generation - Base PenetrationCase

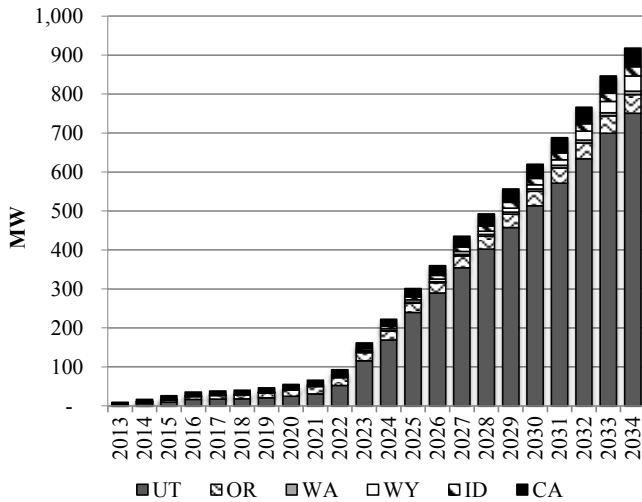

PORTFOLIO SUMMARY

System Optimizer PVRR (\$m)

System Cost without Transmission Upgrades	\$26,565
Transmission Integration	\$31
Transmission Reinforcement	\$6
Total Cost	\$26,602

Resource Portfolio

Cumulative changes to the resource portfolio (new resource additions and resource retirements), represented as nameplate capacity, are summarized in the figure below.

Cumulative Nameplate Capacity

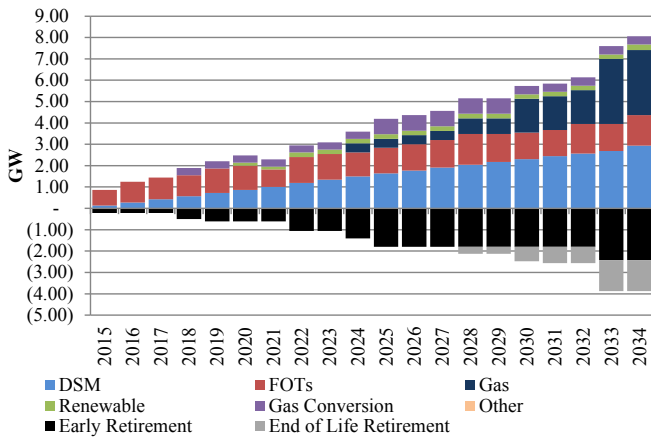

System CO₂ Emissions (System Optimizer)

System CO₂ emissions from System Optimizer are shown alongside those from Cases C05-1 and S-14 in the figure below.

System CO₂ Emissions (System Optimizer)

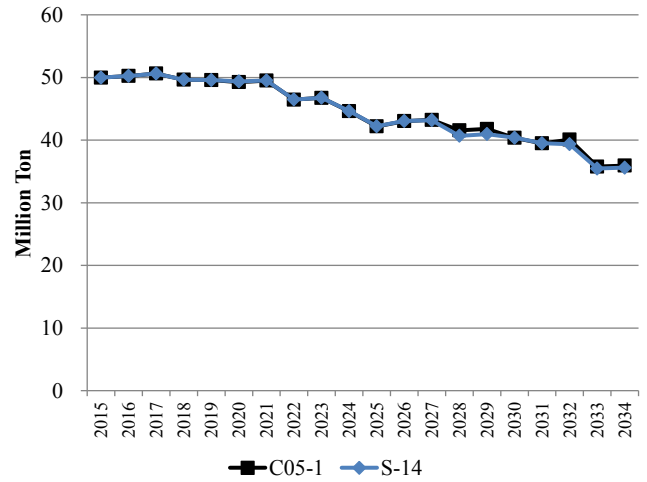

111(d) Compliance Profiles

The following figures summarize how compliance with state emission rate goals is achieved. The sum of each stacked bar represents the fossil emission rate. The net final rate represents the fossil rate after accounting for the emission rate impacts of new thermal (new NGCC units or nuclear, as applicable), re-dispatch of fossil units, energy efficiency (EE), and allocated renewable energy (RE).

PacifiCorp Share of Wyoming Compliance Path (lb/MWh)

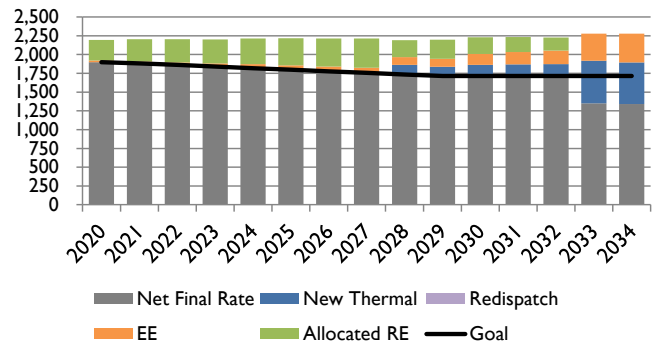

PacifiCorp Share of Utah Compliance Path (lb/MWh)

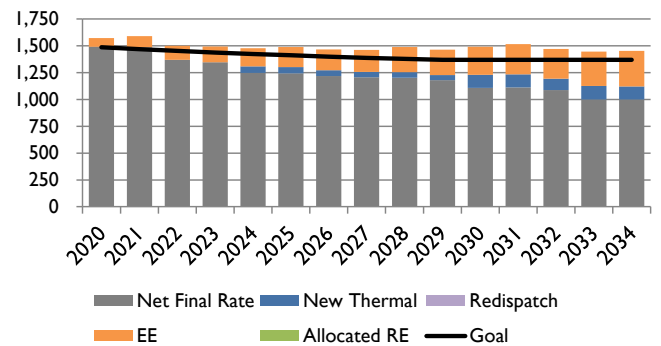

Sensitivity: S-14 (Class 3 DSM)

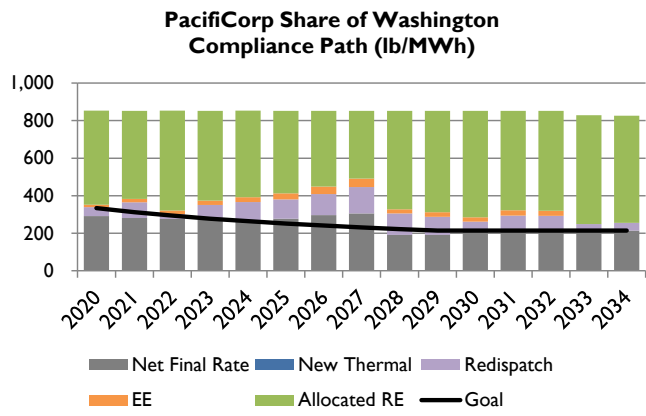
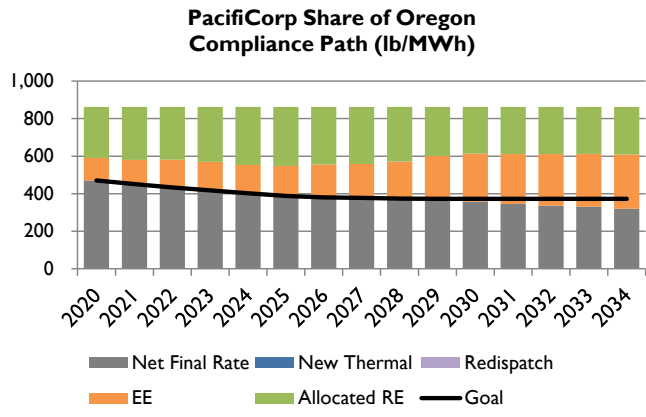

Sensitivity: S-15 (Restricted Allocation)

CASE ASSUMPTIONS

Description

Sensitivity S-15 assumes any renewable electric credits (RECs) used to meet state Renewable Portfolio Standards (RPS) will also be retired to meet EPA 111(d) compliance requirements. As with the other cases this one produced a portfolio that meets PacifiCorp's share of state 111(d) emission rate goals in all states in which PacifiCorp has fossil generation and retail customers. The compliance strategy applied to this case relies on flexible allocation of non-RPS renewable energy and energy efficiency while prioritizing re-dispatch of fossil generation to achieve incremental emission rate reductions as required. For planning purposes, this case assumes Regional Haze Scenario 1 reflecting potential inter-temporal and fleet trade-off compliance outcomes. This sensitivity is a variant of Core Case C05-1.

Federal CO₂ Policy/Price Signal

Sensitivity S-15 reflects EPA's proposed 111(d) rule with no additional CO₂ price signal. The table below summarizes the interim emission rate goal and the final emission rate target by state assumed to apply to PacifiCorp's system.

State	Interim Goal (Avg. 2020-2029) (lb/MWh)	Final Target (2030 & Beyond) (lb/MWh)
WY	1,808	1,714
UT*	1,378	1,322
OR	407	372
WA	264	215

*EPA's calculation of the target for UT treated PacifiCorp's Lakeside 2 NGCC plant as an existing resource. The emission rate assumed for UT assumes Lake Side 2 is correctly classified as "under construction".

The 111(d) compliance strategy implemented for this case is summarized as follows:

- Flexible allocation of system renewable resources and flexible allocation of cumulative energy efficiency savings beginning 2017 from ID and CA, where PacifiCorp does not own fossil generation.
- Cumulative cost-effective selection of energy efficiency beginning 2017.
- New NGCC generation in WY and UT (new NGCC resources are not allowed in OR, WA, and ID).
- Re-dispatch of existing fossil generation, as required.
- Addition of new renewable resources, as required.

Forward Price Curve

Sensitivity S-15 gas and power prices will utilize medium natural gas prices as well as market price impacts associated with EPA's proposed 111(d) rules. These forecasts begin with the Company's base September 30, 2014 official forward price curve.

Nominal Average Annual Henry Hub Gas Prices

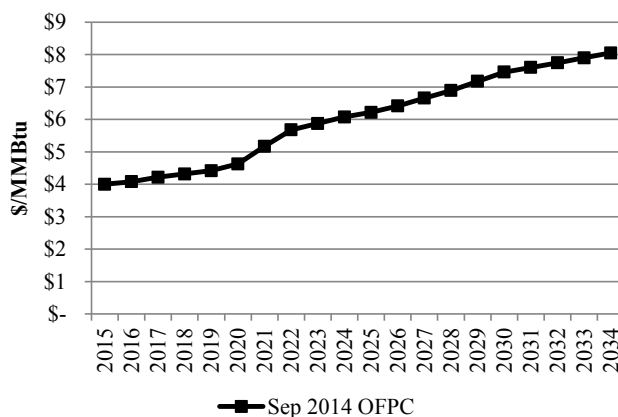

Nominal Average Annual Power Prices (Flat)

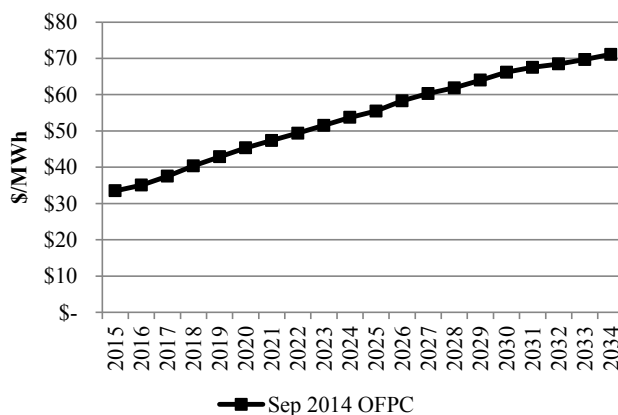

Regional Haze

Sensitivity S-15 reflects Regional Haze Scenario 1, which assumes inter-temporal and fleet trade-off Regional Haze compliance outcomes as shown in the table below. This scenario is for planning purposes recognizing that agency, regulator, and joint owner perspectives on acceptability have not been determined.

Coal Unit	Description
Carbon 1	Shut Down Apr 2015
Carbon 2	Shut Down Apr 2015
Cholla 4	Conversion by Jun 2025
Colstrip 3	SCR by Dec 2023
Colstrip 4	SCR by Dec 2022
Craig 1	SCR by Aug 2021
Craig 2	SCR by Jan 2018
Dave Johnston 1	Shut Down Mar 2019
Dave Johnston 2	Shut Down Dec 2027
Dave Johnston 3	Shut Down Dec 2027
Dave Johnston 4	Shut Down Dec 2032
Hayden 1	SCR by Jun 2015
Hayden 2	SCR by Jun 2016
Hunter 1	SCR by Dec 2021
Hunter 2	Shut Down by Dec 2032
Hunter 3	SCR by Dec 2024
Huntington 1	Shut Down by Dec 2036

Sensitivity: S-15 (Restricted Allocation)

Huntington 2	Shut Down by Dec 2021
Jim Bridger 1	Shut Down by Dec 2023
Jim Bridger 2	Shut Down by Dec 2032
Jim Bridger 3	SCR by Dec 2015
Jim Bridger 4	SCR by Dec 2016
Naughton 1	Shut Down by Dec 2029
Naughton 2	Shut Down by Dec 2029
Naughton 3	Conversion by Jun 2018; Shut Down by Dec 2029
Wyodak	Shut Down by Dec 2039

SCR = selective catalytic reduction

Federal Tax Incentives

- PTCs expire end of 2013
- ITC of 30% expire end of 2016, thereafter it continues in perpetuity at 10%.

Load Forecast

The medium load forecast will be used. The figure below shows the system coincident peak load forecast before accounting for any potential contribution from DSM or distributed generation resources.

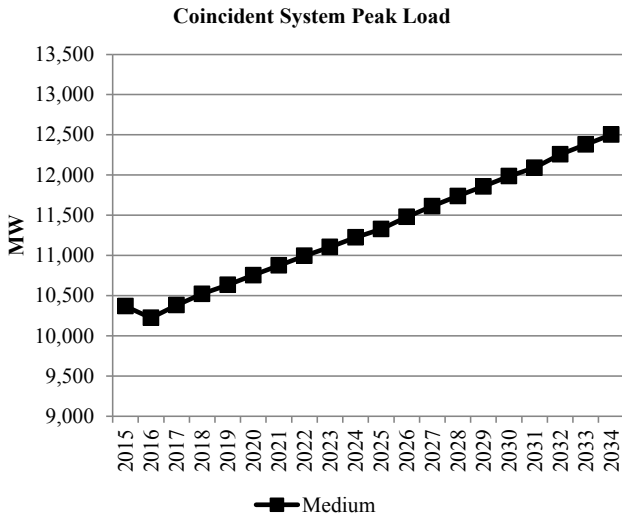

Energy Efficiency (Class 2 DSM)

Base case supply curves and ramp rates with resource selections up to the achievable potential. Class 2 resources that are not selected in any given year are not available for selection in future years. Achievable potential by state and year are summarized below.

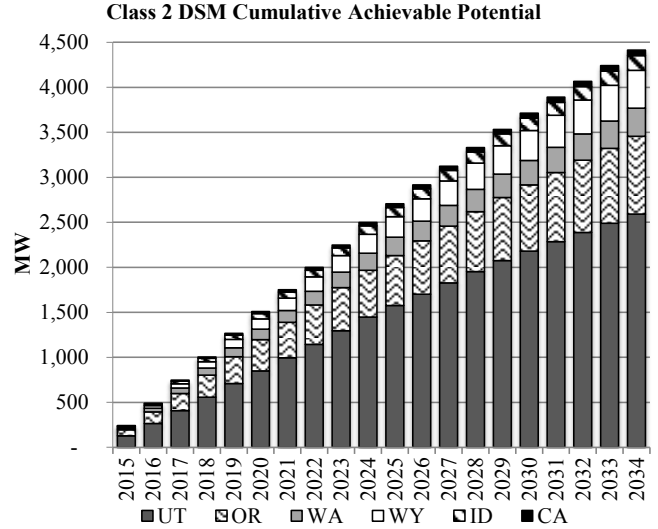

Distributed Generation

Base case distributed generation penetration is assumed in all states. Distributed generation by state and year are summarized below.

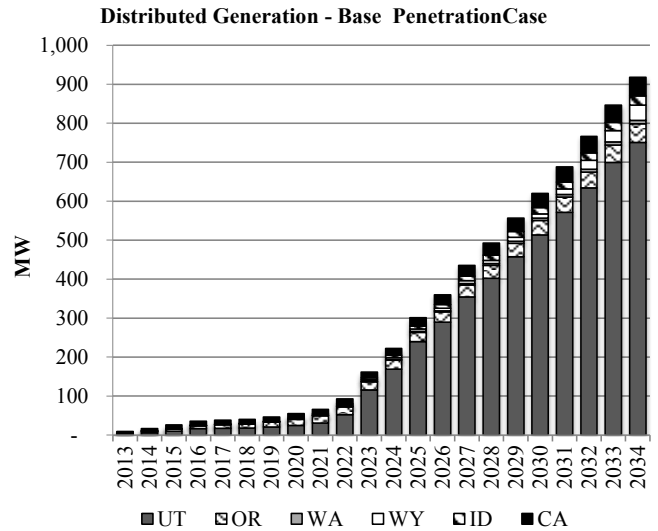

PORTFOLIO SUMMARY

System Optimizer PVRR (\$m)

System Cost without Transmission Upgrades	\$26,985
Transmission Integration	\$66
Transmission Reinforcement	\$6
Total Cost	\$27,057

Sensitivity: S-15 (Restricted Allocation)

Resource Portfolio

Cumulative changes to the resource portfolio (new resource additions and resource retirements), represented as nameplate capacity, are summarized in the figure below.

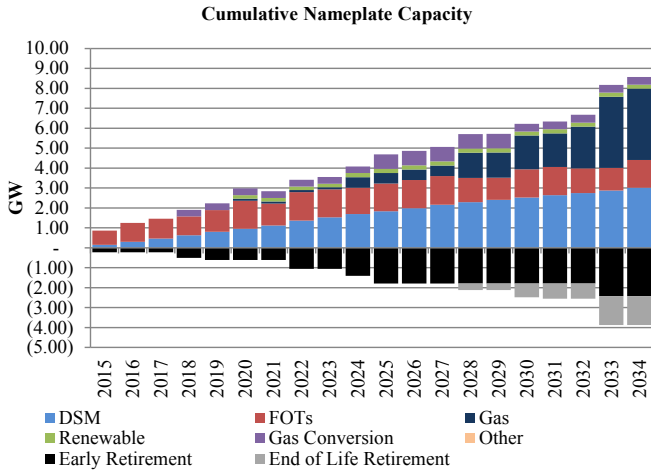

System CO₂ Emissions (System Optimizer)

System CO₂ emissions from System Optimizer are shown alongside those from Cases C05-1 and S-15 in the figure below.

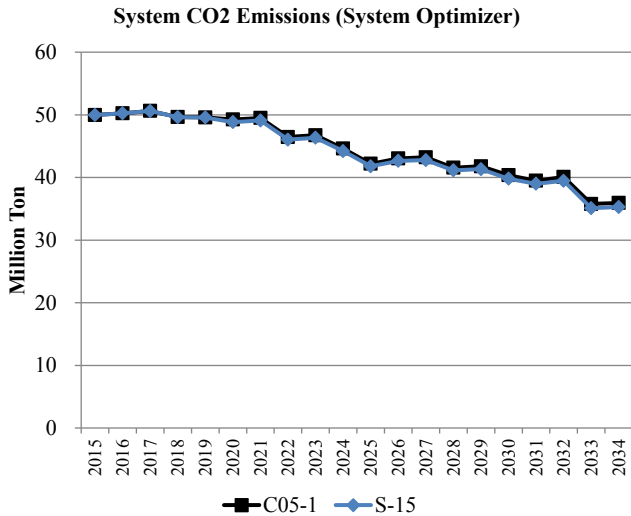

111(d) Compliance Profiles

The following figures summarize how compliance with state emission rate goals is achieved. The sum of each stacked bar represents the fossil emission rate. The net final rate represents the fossil rate after accounting for the emission rate impacts of new thermal (new NGCC units or nuclear, as applicable), re-dispatch of fossil units, energy efficiency (EE), and allocated renewable energy (RE).

PacifiCorp Share of Wyoming Compliance Path (lb/MWh)

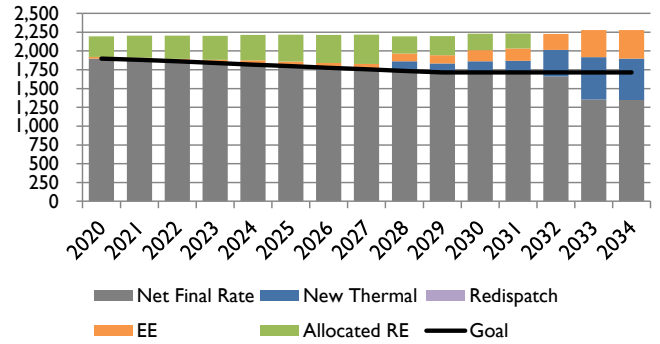

PacifiCorp Share of Wyoming Compliance Path (lb/MWh)

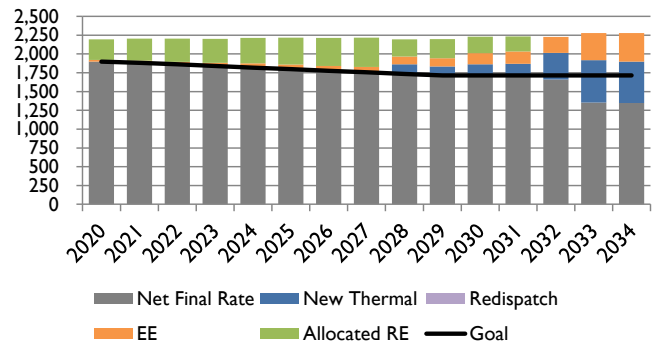

PacifiCorp Share of Wyoming Compliance Path (lb/MWh)

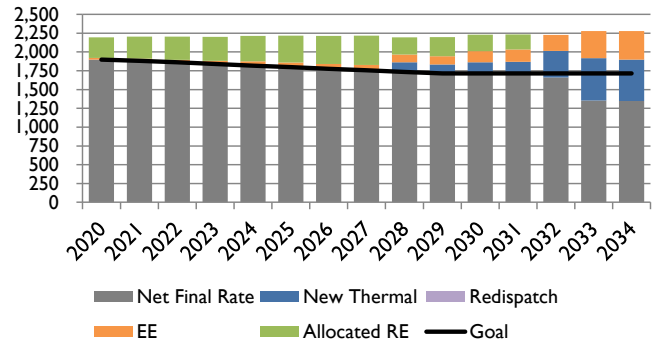

PacifiCorp Share of Washington Compliance Path (lb/MWh)

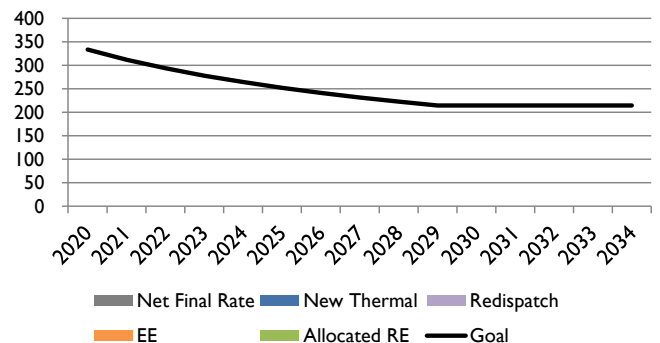

APPENDIX N – 2014 WIND AND SOLAR CAPACITY CONTRIBUTION STUDY

Introduction

The capacity contribution of wind and solar resources, represented as a percentage of resource capacity, is a measure of the ability for these resources to reliably meet demand. For purposes of this report, PacifiCorp defines the peak capacity contribution of wind and solar resources as the availability among hours with the highest loss of load probability (LOLP). PacifiCorp calculated peak capacity contribution values for wind and solar resources using the capacity factor approximation method (CF Method) as outlined in a 2012 report produced by the National Renewable Energy Laboratory (NREL Report)⁴⁷.

The capacity contribution of wind and solar resources affects PacifiCorp’s resource planning activities. PacifiCorp conducts its resource planning to ensure there is sufficient capacity on its system to meet its load obligation at the time of system coincident peak inclusive of a planning reserve margin. To ensure resource adequacy is maintained over time, all resource portfolios evaluated in the integrated resource plan (IRP) have sufficient capacity to meet PacifiCorp’s net coincident peak load obligation inclusive of a planning reserve margin throughout a 20-year planning horizon. Consequently, planning for the coincident peak drives the amount and timing of new resources, while resource cost and performance metrics among a wide range of different resource alternatives drive the types of resources that can be chosen to minimize portfolio costs and risks.

PacifiCorp derives its planning reserve margin from a LOLP study. The study evaluates the relationship between reliability across all hours in a given year, accounting for variability and uncertainty in load and generation resources, and the cost of planning for system resources at varying levels of planning reserve margin. In this way, PacifiCorp’s planning reserve margin LOLP study is the mechanism used to transform hourly reliability metrics into a resource adequacy target at the time of system coincident peak. This same LOLP study was utilized for calculating the peak capacity contribution using the CF Method. Table N.1 summarizes the peak capacity contribution results for PacifiCorp’s east and west balancing authority areas (BAAs).

Table N.1 – Peak Capacity Contribution Values for Wind and Solar

	East BAA			West BAA		
	Wind	Fixed Tilt Solar PV	Single Axis Tracking Solar PV	Wind	Fixed Tilt Solar PV	Single Axis Tracking Solar PV
Capacity Contribution Percentage	14.5%	34.1%	39.1%	25.4%	32.2%	36.7%

⁴⁷ Madaeni, S. H.; Sioshansi, R.; and Denholm, P. “Comparison of Capacity Value Methods for Photovoltaics in the Western United States.” NREL/TP-6A20-54704, Denver, CO: National Renewable Energy Laboratory, July 2012 (NREL Report). <http://www.nrel.gov/docs/fy12osti/54704.pdf>

Methodology

The NREL Report summarizes several methods for estimating the capacity value of renewable resources that are broadly categorized into two classes: 1) reliability-based methods that are computationally intensive; and 2) approximation methods that use simplified calculations to approximate reliability-based results. The NREL Report references a study from Milligan and Parsons that evaluated capacity factor approximation methods, which use capacity factor data among varying sets of hours, relative to the more computationally intensive reliability-based effective load carrying capability (ELCC) metric. As discussed in the NREL Report, the CF Method was found to be the most dependable technique in deriving capacity contribution values that approximate those developed using the ELCC Method.

As described in the NREL Report, the CF Method “considers the capacity factor of a generator over a subset of periods during which the system faces a high risk of an outage event.” When using the CF Method, hourly LOLP is calculated and then weighting factors are obtained by dividing each hour’s LOLP by the total LOLP over the period. These weighting factors are then applied to the contemporaneous hourly capacity factors for a wind or solar resource to produce a weighted average capacity contribution value.

The weighting factors based on LOLP are defined as:

$$w_i = \frac{LOLP_i}{\sum_{j=1}^T LOLP_j}$$

where w_i is the weight in hour i , $LOLP_i$ is the LOLP in hour i , and T is the number of hours in the study period, which is 8,760 hours for the current study. These weights are then used to calculate the weighted average capacity factor as an approximation of the capacity contribution as:

$$CV = \sum_{i=1}^T w_i C_i,$$

where C_i is the capacity factor of the resource in hour i , and CV is the weighted capacity value of the resource.

To determine the capacity contribution using the CF method, PacifiCorp implemented the following two steps:

1. A 500-iteration hourly Monte Carlo simulation of PacifiCorp’s system was produced using the Planning and Risk (PaR) model to simulate the dispatch of the Company’s system for a sample year (calendar year 2017). This PaR study is based on the Company’s 2015 IRP planning reserve margin study using a 13% target planning reserve margin level. The LOLP for each hour in the year is calculated by counting the number of iterations in an hour in which system load could not be met with available resources and dividing by 500 (the total number iterations). For example, if in hour 9 on January 12th there are two iterations with Energy Not Served (ENS) out of a total of 500 iterations, then the LOLP for that hour would be 0.4%.⁴⁸

⁴⁸ 0.4% = 2 / 500.

2. Weighting factors were determined based upon the LOLP in each hour divided by the sum of LOLP among all hours. In the example noted above, the sum of LOLP among all hours is 143%.⁴⁹ The weighting factor for hour 9 on January 12th would be 0.2797%.⁵⁰ The hourly weighting factors are then applied to the capacity factors of wind and solar resources in the corresponding hours to determine the weighted capacity contribution value in those hours. Extending the example noted, if a resource has a capacity factor of 41.0% in hour 9 on January 12th, its weighted annual capacity contribution for that hour would be 0.1146%.⁵¹

Results

Table N.2 summarizes the resulting annual capacity contribution using the CF Method described above as compared to capacity contribution values assumed in the 2013 IRP.⁵² In implementing the CF Method, PacifiCorp used actual wind generation data from wind resources operating in its system to derive hourly wind capacity factor inputs. For solar resources, PacifiCorp used hourly generation profiles, differentiated between single axis tracking and fixed tilt projects, from a feasibility study developed by Black and Veatch. A representative profile for Milford County, Utah was used to calculate East BAA solar capacity contribution values, and a representative profile for Lakeview County, Oregon was used to calculate West BAA solar capacity contribution values.

Table N.2 – Peak Capacity Contribution Values for Wind and Solar

	East BAA			West BAA		
	Wind	Fixed Tilt Solar PV	Single Axis Tracking Solar PV	Wind	Fixed Tilt Solar PV	Single Axis Tracking Solar PV
CF Method Results	14.5%	34.1%	39.1%	25.4%	32.2%	36.7%
2013 IRP Results	4.2%	13.6%	n/a	4.2%	13.6%	n/a

Figure N.1 presents daily average LOLP results from the PaR simulation, which shows that loss of load events are most likely to occur during the spring, when maintenance is often planned, and during peak load months, which occur in the summer and the winter.

⁴⁹ For each hour, the hourly LOLP is calculated as the number of iterations with ENS divided by the total of 500 iterations. There are 715 ENS iteration-hours out of total of 8,760 hours. As a result, the sum of LOLP is $715 / 500 = 143\%$.

⁵⁰ $0.2797\% = 0.4\% / 143\%$, or simply $0.2797\% = 2 / 715$.

⁵¹ $0.1146\% = 0.2797\% \times 41.0\%$.

⁵² In its 2013 IRP, PacifiCorp estimated capacity contribution values for wind and solar resources by evaluating capacity factors for wind and solar resources at a 90% probability level among the top 100 load hours in a given year.

Figure N.1 – Daily LOLP

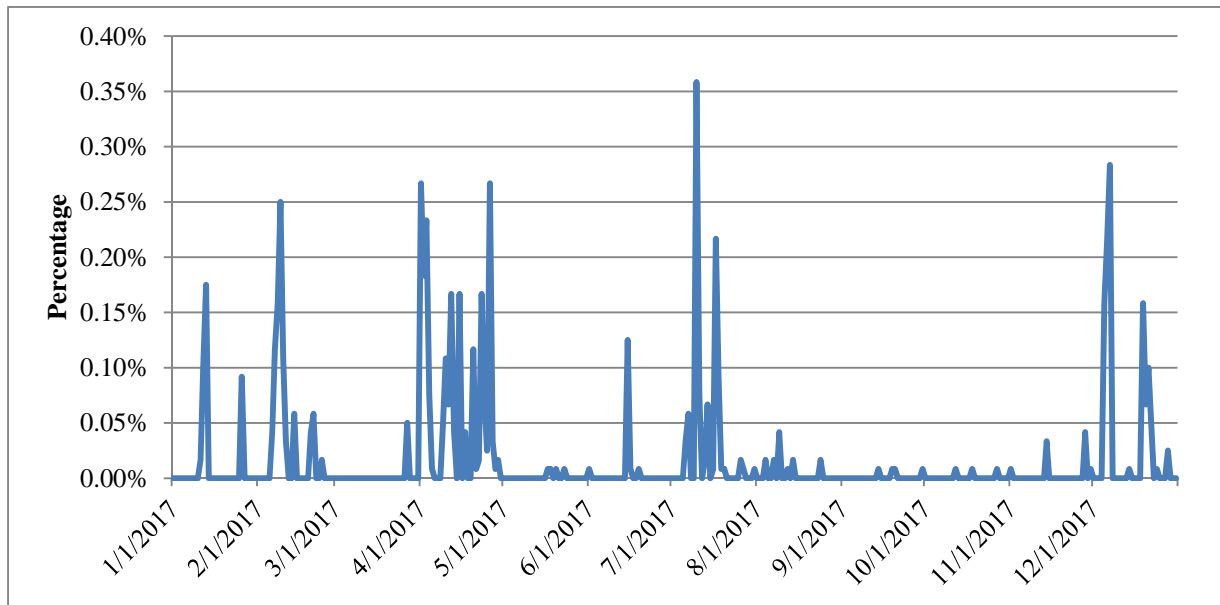

Figure N.2 presents the relationship between monthly capacity factors among wind and solar resources (primary y-axis) and average monthly LOLP from the PaR simulation (secondary y-axis) in PacifiCorp’s CF Method analysis. As noted above, the average monthly LOLP is most prominent in April (spring maintenance period), summer (July peak loads), and winter (when loads are high).

Figure N.2 – Monthly Resource Capacity Factors as Compared to LOLP

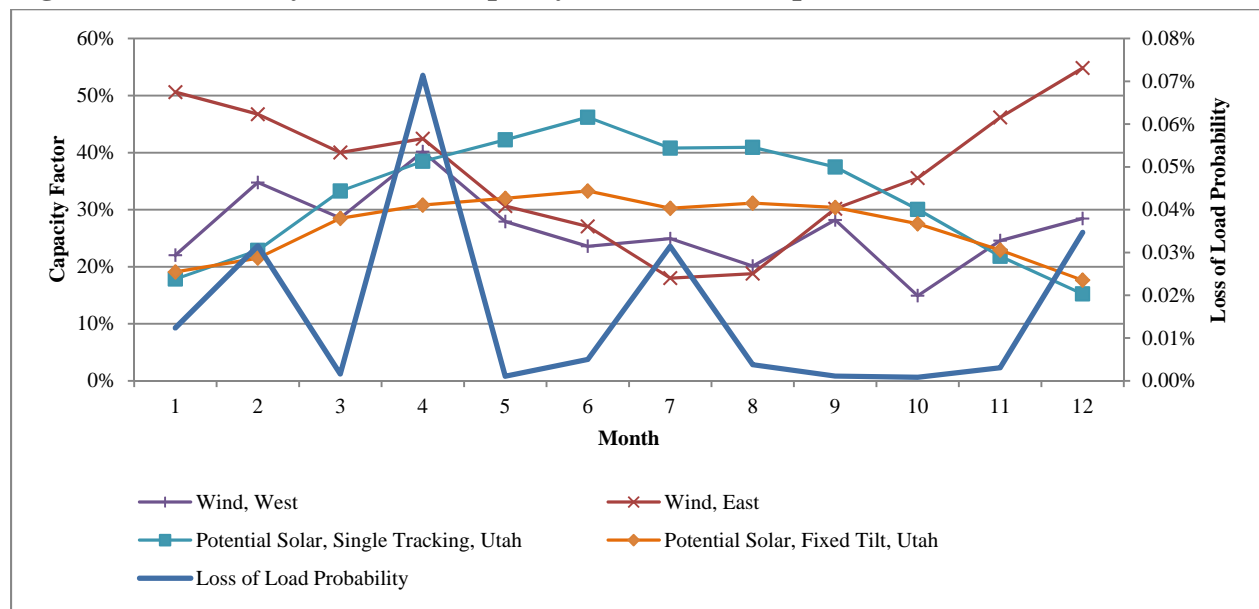

Figure N.3 through Figure N.5 present the hourly distribution of capacity factors among wind and solar resources (primary y-axis) as compared to the hourly distribution of LOLP (secondary y-axis) for a typical day in the months of April, July, and December, respectively. Among a typical day in April, LOLP events peak during morning and evening ramp periods when generating units are transitioning between on-peak and off-peak operation. Among a typical day

in July, LOLP events peak during higher load hours and during the evening ramp. In December, LOLP events peak during higher load evening hours.

Figure N.3 – Hourly Resource Capacity Factors as Compared to LOLP for an Average Day in April

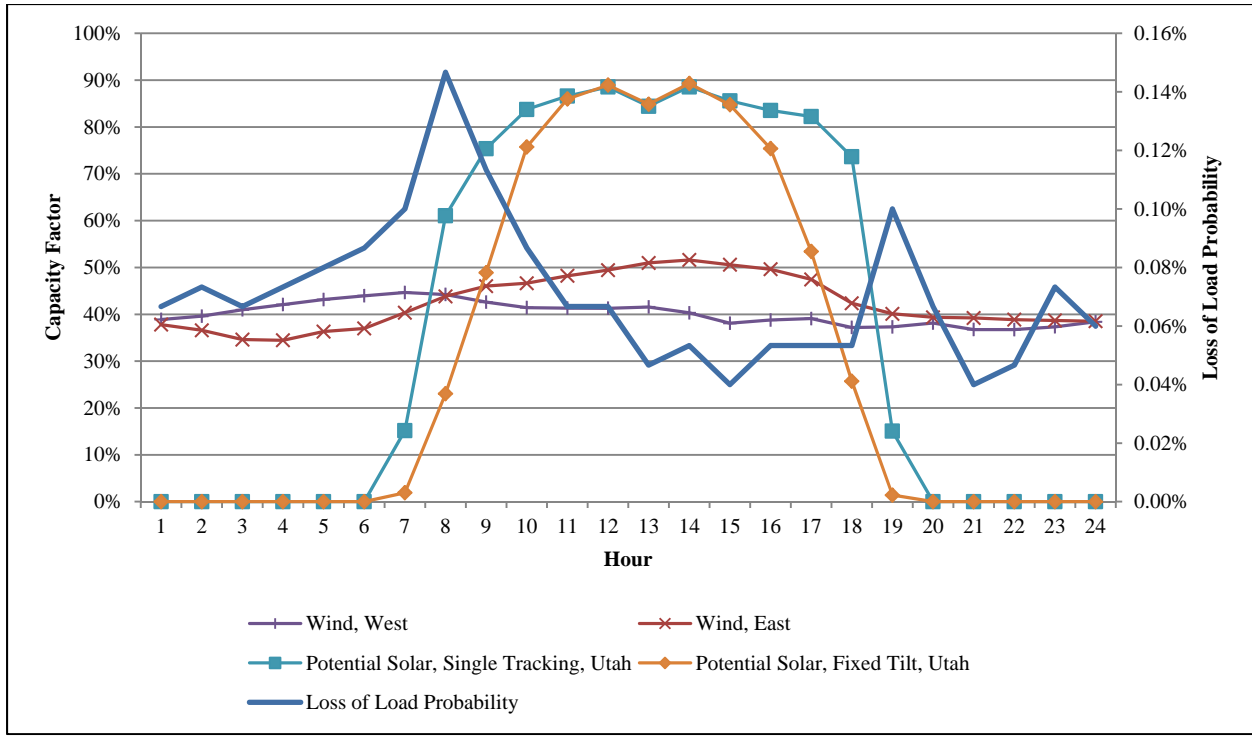

Figure N.4 – Hourly Resource Capacity Factors as Compared to LOLP for an Average Day in July

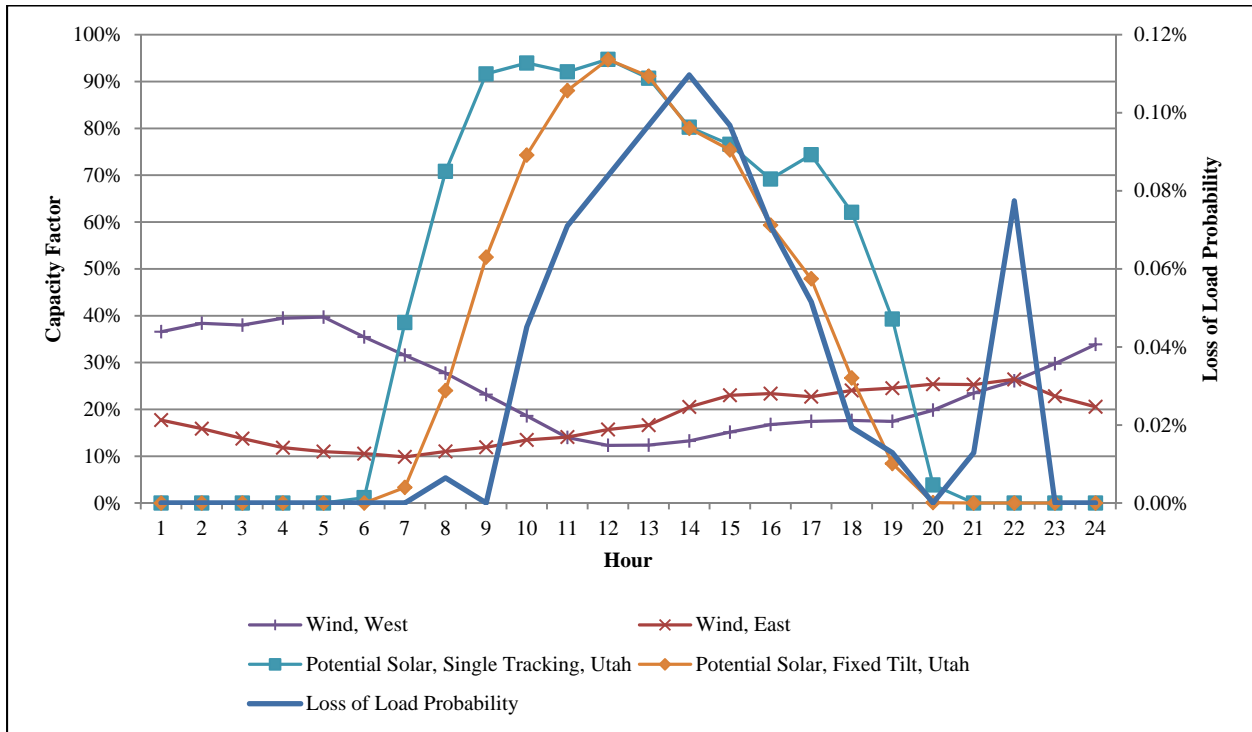
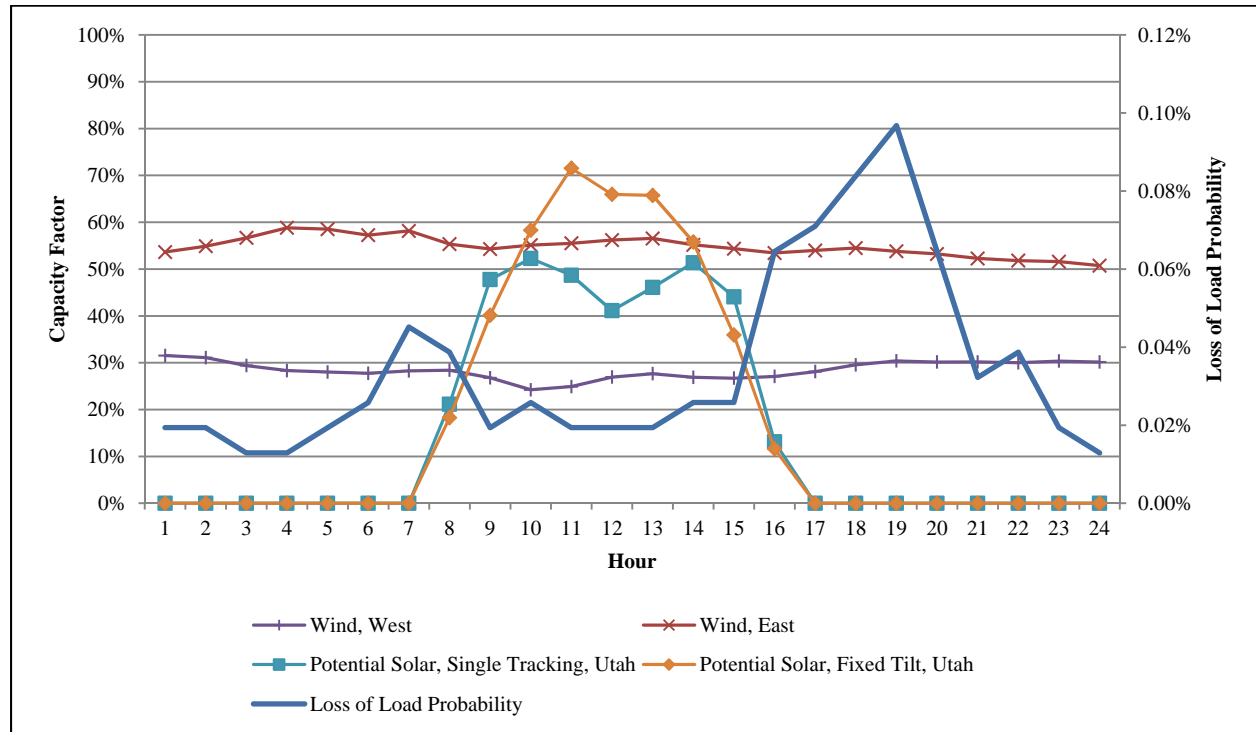

Figure N.5 – Hourly Resource Capacity Factors as Compared to LOLP for an Average Day in December



Conclusion

PacifiCorp conducts its resource planning by ensuring there is sufficient capacity on its system to meet its net load obligation at the time of system coincident peak inclusive of a planning reserve margin. The peak capacity contribution of wind and solar resources, represented as a percentage of resource capacity, is the weighted average capacity factor of these resources at the time when the load cannot be met with available resources. The peak capacity contribution values developed using the CF Method are based on a LOLP study that aligns with PacifiCorp’s 13% planning reserve margin, and therefore, the values represent the expected contribution that wind and solar resources make toward achieving PacifiCorp’s target resource planning criteria.

APPENDIX O – DISTRIBUTED GENERATION RESOURCE ASSESSMENT STUDY

Introduction

Navigant Consulting, Inc. prepared this Distributed Generation Resource Assessment for Long-term Planning Study on behalf of PacifiCorp. A key objective of this research is to assist PacifiCorp in developing distributed generation resource penetration forecasts to support its 2015 IRP. The purpose of this study is to project the level of distributed resources PacifiCorp's customers might install over the next twenty years.



Distributed Generation Resource Assessment for Long-Term Planning Study

Supply Curve Support

Prepared for:
PacifiCorp



Prepared by:
Karin Corfee
Graham Stevens
Shalom Goffri

June 9, 2014



Navigant Consulting, Inc.
One Market Street
Spear Street Tower, Suite 1200
San Francisco, CA 94105

415.356.7100
www.navigant.com

Reference No.: 171094

Table of Contents

Executive Summary	v
Key Findings.....	vii
1. Introduction	1-1
1.1 Methodology	1-2
1.2 Report Organization	1-3
2. DG Technology Definitions	2-1
2.1 What is a “Distributed Generation” Source?	2-1
2.1.1 Size Limits for this Study	2-1
2.1.2 Determination of Applicable Technologies	2-2
2.1.3 Solar DG Technology Definition.....	2-3
2.1.4 Small Distributed Wind Technology Definition	2-5
2.1.5 Small Scale Hydro Technology Definition.....	2-7
2.1.6 CHP Reciprocating Engines Technology Definition	2-10
2.1.7 CHP Microturbine Technology Definition	2-14
3. Resource Cost & Performance Assumptions	3-1
3.1 Photovoltaic	3-1
3.1.1 Performance	3-1
3.1.2 Cost	3-3
3.2 Small-Scale Wind	3-5
3.2.1 Performance	3-5
3.2.2 Cost	3-5
3.3 Small-Scale Hydro	3-6
3.3.1 Performance	3-6
3.3.2 Cost	3-7
3.4 CHP Reciprocating Engines	3-8
3.4.1 Performance	3-8
3.4.2 Cost	3-8
3.5 CHP Micro-turbines	3-9
3.5.1 Performance	3-9
3.5.2 Cost	3-9
4. DG Market Potential and Barriers.....	4-1
4.1 Incentives	4-1
4.1.1 Federal Incentives	4-1
4.1.2 State Incentives	4-1
4.1.3 Rebate Incentives.....	4-3
4.2 Market Barriers to DG Penetration.....	4-4

4.2.1 Technical Barriers.....	4-4
4.2.2 Economic Barriers	4-5
4.2.3 Legal / Regulatory Barriers	4-6
4.2.4 Institutional Barriers	4-6
5. Methodology to Develop 2015 IRP DG Penetration Forecasts	5-1
5.1 Market Penetration Approach.....	5-1
5.1.1 Assess Technical Potential	5-1
5.1.2 Simple Payback.....	5-7
5.1.3 Payback Acceptance Curves.....	5-9
5.1.4 Market Penetration Curves.....	5-9
5.1.5 Scenarios.....	5-13
6. Results.....	6-1
6.1 Technical Potential.....	6-1
6.2 Overall Scenario Results	6-2
6.3 Results by State	6-5
6.4 Results by Technology	6-15
Appendix A. Glossary	A-1
Appendix B. Summary Table of Results	B-2

List of Figures and Tables

Figures:

Figure 1-1. PacifiCorp Service Territory	vi
Figure 1-2. Technical Potential Results	vii
Figure 1-3. Distributed Generation Supply Curve Results, Base Case	viii
Figure 1-4. Low and High Penetration Scenario Results.....	ix
Figure 1-1. PacifiCorp Service Territory	1-2
Figure 2-1. Solar Technology Types	2-3
Figure 2-2. PV System Applications.....	2-4
Figure 2-3. Wind Turbine Examples	2-5
Figure 2-4. U.S. SWT Sales, by Market Segment (2007-2012).....	2-7
Figure 2-5. Small Hydro Definition.....	2-8
Figure 2-6. Small Hydro Sizes	2-9
Figure 2-7. Example Small Hydro Sites, Turbines	2-9
Figure 2-8. Residential CHP Schematic	2-11
Figure 2-9. Typical Commercial CHP System Components.....	2-11
Figure 2-10. Reciprocating Engine Cutaway.....	2-12
Figure 2-11. Diesel/Gas-Fired DG Technology Applications.....	2-13
Figure 2-12. Reciprocating Engine Sizes and Fuels Used.....	2-13
Figure 2-13. Microturbine Schematic	2-14
Figure 2-14. Example Micro-turbines (Capstone Turbine Corporation).....	2-14
Figure 3-1. Example Solar Panels: Mono-crystalline and Poly-crystalline	3-1
Figure 3-2. Typical Crystalline Solar Cell Cross Section	3-2
Figure 3-3. Example Solar Module Power Warranty	3-2
Figure 3-4. Photovoltaic Module Price Trends.....	3-4
Figure 3-5. Hydropower project capacity factors in the Clean Development Mechanism.....	3-6
Figure 4-1. Net Metering Policies in the U.S.	4-6
Figure 4-2. US Benchmark Interest Rate	4-7
Figure 5-1. US Wind Resource Map	5-6
Figure 5-2. Payback Acceptance Curves.....	5-9
Figure 5-3. Fisher-Pry Market Penetration Dynamics	5-11
Figure 5-4. DG Market Penetration Curves Used	5-12
Figure 6-1. Technical Potential Results	6-1
Figure 6-2. Base Case Results	6-2
Figure 6-3. Low Penetration Scenario Results	6-3
Figure 6-4. High Penetration Scenario Results	6-4
Figure 6-5. Utah Base Case Results	6-5
Figure 6-6. Utah Residential PV Market Drivers.....	6-7
Figure 6-7. Utah Small Commercial PV Market Drivers	6-8
Figure 6-8. Utah Near-Term PV Projections	6-9
Figure 6-9. California Base Case Results	6-10
Figure 6-10. Idaho Base Case Results.....	6-11

Figure 6-11. Oregon Base Case Results.....	6-12
Figure 6-12. Washington Base Case Results.....	6-13
Figure 6-13. Wyoming Base Case Results	6-14
Figure 6-14. Reciprocating Engines Base Case Results.....	6-15
Figure 6-15. Micro-turbines Base Case Results.....	6-16
Figure 6-16. Small Hydro Base Case Results	6-17
Figure 6-17. Photovoltaics Base Case Results	6-18
Figure 6-18. Photovoltaics Residential Base Case Results.....	6-19
Figure 6-19. Photovoltaic Commercial Base Case Results	6-20
Figure 6-20. Small Wind Base Case Results	6-21
Figure 6-21. Small Wind Residential Results	6-22
Figure 6-22. Small Wind Commercial Results	6-23

Tables:

Table 2-1. PacifiCorp Net Metering Limits	2-1
Table 2-2. Applicable DG Technologies	2-2
Table 2-3. Common Applications for Small Wind Systems.....	2-6
Table 3-1. PV Installation and Maintenance Cost Assumptions	3-3
Table 3-2. Small Scale Wind Cost Assumptions	3-5
Table 3-3. Small Scale Hydro Cost Assumptions	3-7
Table 3-4. CHP Reciprocating Engines Cost Assumptions.....	3-8
Table 3-5. CHP Microturbine Cost Assumptions	3-9
Table 4-1. State Tax Incentives	4-2
Table 4-2. Rebate Incentives	4-3
Table 5-1. CHP Technical Potential.....	5-2
Table 5-2. CHP Install Base	5-3
Table 5-3. Small Hydro Technical Potential Results	5-4
Table 5-4. PV System Size per Customer Class Example (Utah).....	5-5
Table 5-5. Utah PV Technical Potential.....	5-5
Table 5-6. Small Wind Technical Potential Results.....	5-7
Table 5-7. Residential Tax Rates	5-8
Table 5-8. Commercial Tax Rate	5-8
Table 5-9. Scenario Variable Modifications.....	5-13

Disclaimer

This report was prepared by Navigant Consulting, Inc. exclusively for the benefit and use of PacifiCorp and/or its affiliates or subsidiaries. The work presented in this report represents our best efforts and judgments based on the information available at the time this report was prepared. Navigant Consulting, Inc. is not responsible for the reader's use of, or reliance upon, the report, nor any decisions based on the report.

NAVIGANT CONSULTING, INC. MAKES NO REPRESENTATIONS OR WARRANTIES, EXPRESSED OR IMPLIED.

Readers of this report are advised that they assume all liabilities incurred by them, or third parties, as a result of their reliance on this report, or the data, information, findings and opinions contained in this report.

June 9, 2014

Executive Summary

Navigant Consulting, Inc. (Navigant) prepared this Distributed Generation Resource Assessment for Long-term Planning Study on behalf of PacifiCorp. A key objective of this research is to assist PacifiCorp in developing distributed generation resource penetration forecasts to support its 2015 Integrated Resource Plan (IRP). The purpose of this study is to project the level of distributed resources PacifiCorp’s customers might install over the next twenty years.

Navigant evaluated five Distributed Generation resources in detail in this report:

1. Photovoltaic (Solar)
2. Small Scale Wind
3. Small Scale Hydro
4. Combined Heat and Power Reciprocating Engines
5. Combined Heat and Power Micro-turbines

Other technologies were excluded as they were: 1) analyzed elsewhere for the IRP; 2) are too large to be considered “Distributed” resources; or 3) are not economically viable on a large scale. Project sizes were restricted to be less than the size limits of the relevant state net metering regulation, i.e. less than 2 MW in Oregon and Utah; <1 MW in CA; <100 kW in ID and WA; and <25 kW in WY.

Distributed generation technical potential and market penetration was estimated by technology and by geography, i.e. the portion of the individual states that are in PacifiCorp’s service territory, including parts of California, Idaho, Oregon, Utah, Washington, and Wyoming (Figure 1-1).

Figure 1-1. PacifiCorp Service Territory¹



¹ http://www.pacificorp.com/content/dam/pacificorp/doc/About_Us/Company_Overview/Service_Area_Map.pdf

Key Findings

Using public data sources for costs and technology performance, Navigant conducted a Fisher-Pry² payback analysis to determine market penetration for DG technologies. This was done for individual residential and commercial customers of PacifiCorp by rate class.

Navigant estimates approximately 10 GW of technical potential in PacifiCorp’s territory. As displayed in Figure 1-2, PV technology represents the highest technical potential across the five technologies examined.

Figure 1-2. Technical Potential Results

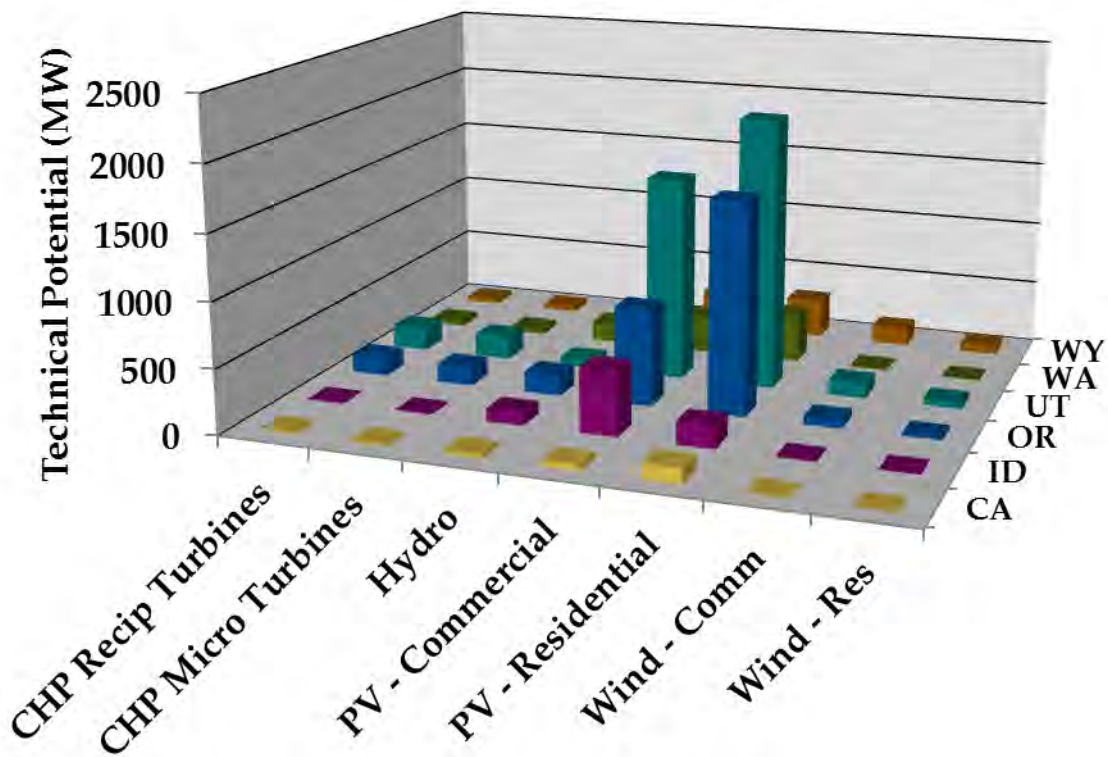

The main body of the report contains results by state, technology, and sector.

² Fisher-Pry are researchers who studied the economics of “S-curves”, which describe how quickly products penetrate the market. They codified their findings based on payback period, which measures how long it takes to recoup initial high first costs with energy savings over time.

Our overall results reflect our base case market penetration analysis, and we found that the near term outlook is roughly 50 MW in 2019 and reaches 900 MW by 2034, the end of the IRP period (Figure 1-3).

Figure 1-3. Distributed Generation Supply Curve Results, Base Case

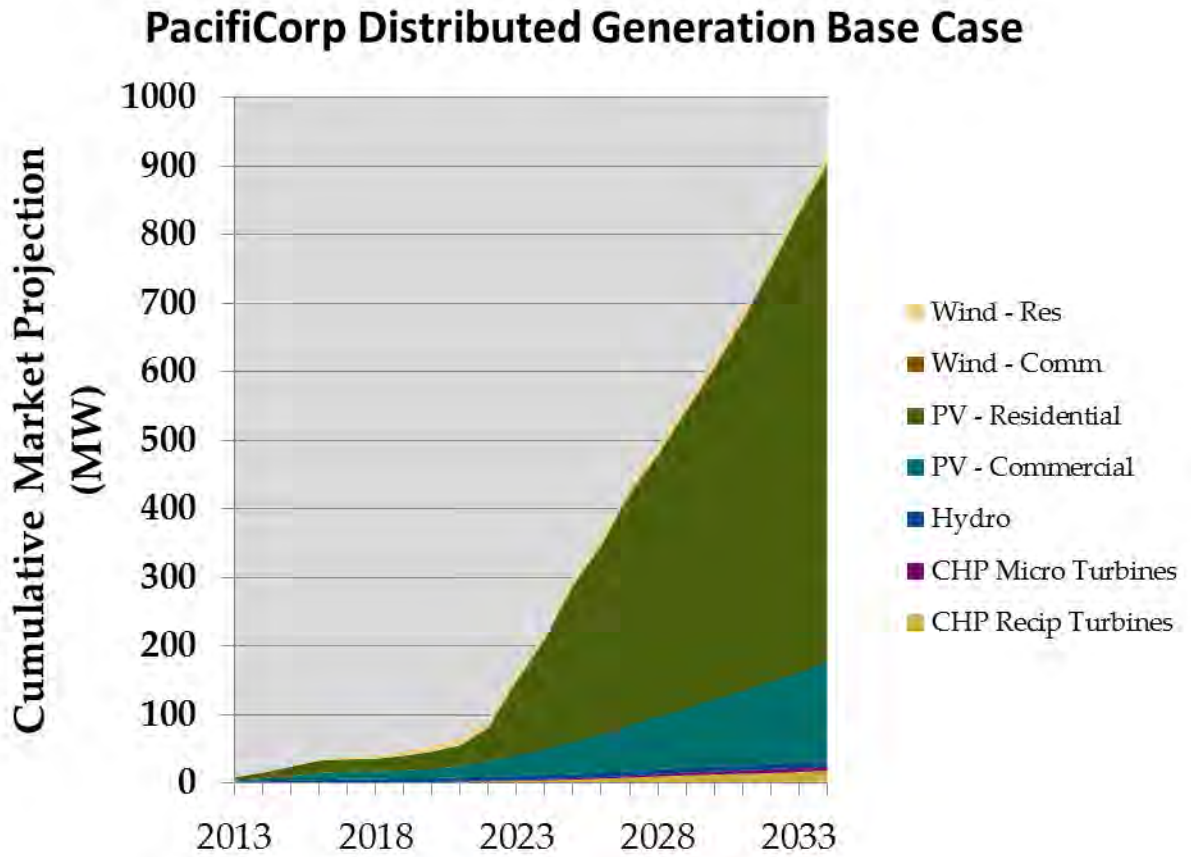

In the low and high penetration cases, 33 MW and 95MW penetration is achieved by 2019, rapidly expanding thereafter to achieve 290 and 2630 MW of penetration in 2034, respectively (Figure 1-4).

Figure 1-4. Low and High Penetration Scenario Results

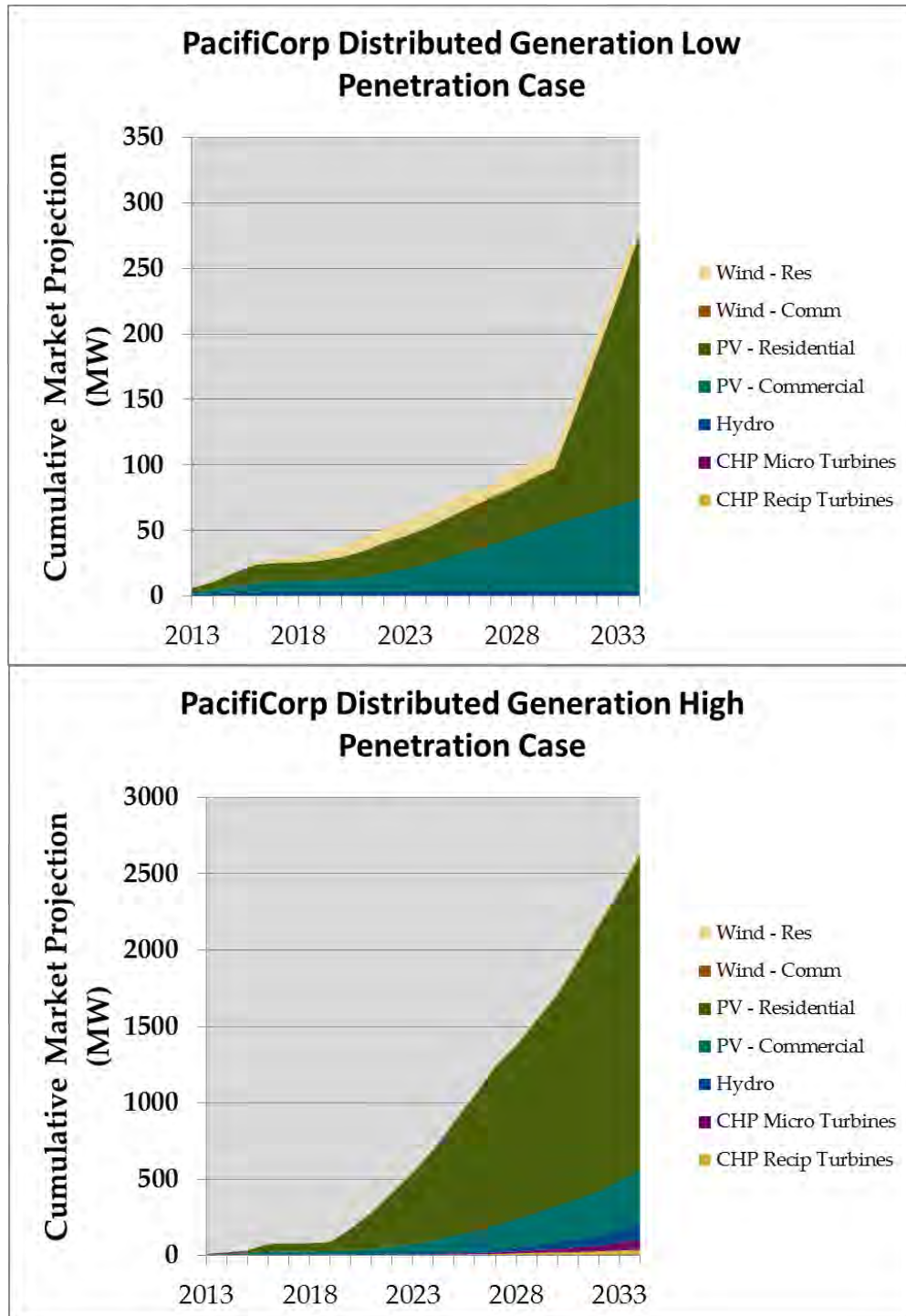

1. Introduction

Navigant Consulting, Inc. (Navigant) prepared this Distributed Generation Resource Assessment for Long-term Planning Study on behalf of PacifiCorp. A key objective of this research is to assist PacifiCorp in developing distributed generation resource penetration forecasts to support its 2015 Integrated Resource Plan (IRP). The purpose of this study is to project the level of distributed resources PacifiCorp's customers will install over the next 20 years. Navigant evaluated five distributed generation resources in detail in this report:

1. Photovoltaic (Solar)
2. Small Scale Wind
3. Small Scale Hydro
4. Combined Heat and Power Reciprocating Engines
5. Combined Heat and Power Micro-turbines

Other technologies were excluded as they were: 1) analyzed elsewhere for the IRP; 2) are too large to be considered "Distributed" resources; or 3) are not economically viable on a large scale. Project sizes were restricted to be less than the size limits of the relevant state net metering regulation, i.e. less than 2 MW in Oregon and Utah; <1 MW in CA; <100 kW in ID and WA; and <25 kW in WY.

Distributed generation technical potential and market penetration was estimated by technology and by geography, i.e. the portion of the individual states that are in PacifiCorp's service territory, including parts of California, Idaho, Oregon, Utah, Washington, and Wyoming (Figure 1-1).

Figure 1-1. PacifiCorp Service Territory³

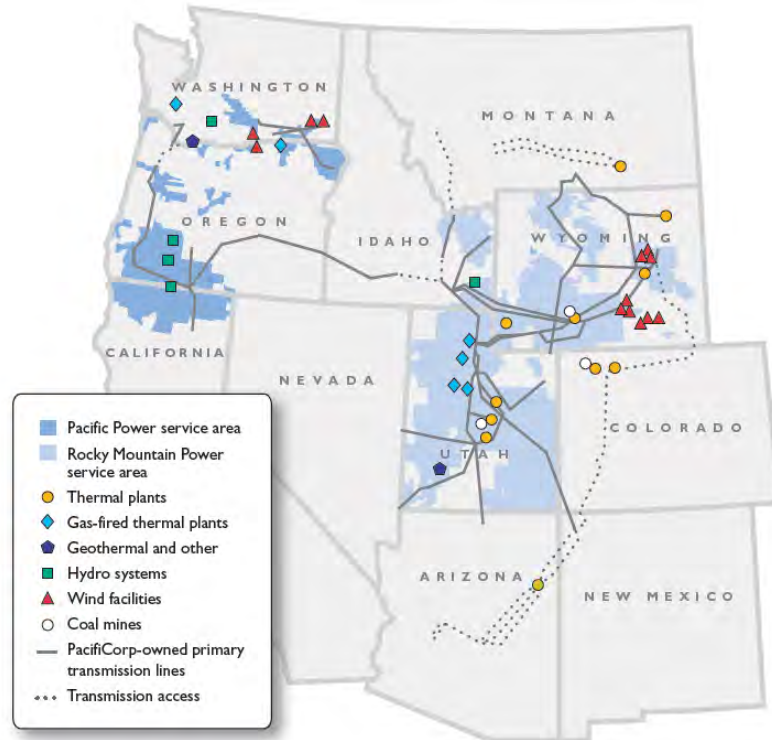

1.1 Methodology

In assessing the technical and market potential of each distributed generation (DG) resource and opportunity in PacifiCorp’s service area, the study considered a number of key factors, including:

- Technology maturity, costs, & future cost improvements
- Industry practices, current and expected
- Net metering policies
- Tax incentives
- Utility rebates
- O&M costs
- Historical performance, and expected performance improvements
- Availability of DG resources
- Consumer behavior and market penetration

³ http://www.pacificorp.com/content/dam/pacificorp/doc/About_Us/Company_Overview/Service_Area_Map.pdf

Using public data sources for costs and technology performance, Navigant conducted a Fisher-Pry⁴ payback analysis to determine market penetration for DG technologies. This was done for individual residential and commercial customers of PacifiCorp by rate class.

A five-step process was used to determine the IRP penetration scenarios for DG resources:

1. **Assess a Technology’s Technical Potential:** Technical potential is the amount of a technology that can be physically installed without considering economics.
2. **Calculate First Year Simple Payback Period for Each Year of Analysis:** From past work in projecting the penetration of new technologies, Navigant has found that Simple Payback Period is the best indicator of uptake. Navigant used all relevant federal, state, and utility incentives in its calculation of paybacks, including their expiration dates.
3. **Project Ultimate Adoption Using Payback Acceptance Curves:** Payback Acceptance Curves estimate what percentage of a market will ultimately adopt a technology, but do not factor in how long adoption will take.
4. **Project Market Penetration Using Market Penetration Curves:** Market penetration curves factor in market and technology characteristics to project how long adoption will take.
5. **Project Market Penetration under Different Scenarios.** In addition to the Base Case scenario, a High and Low Case scenarios were evaluated that used different 20-year average cost assumptions, performance assumptions, and electricity rate assumptions.

Navigant examined the cost of electricity from the customer perspective, called “levelized cost of energy” (LCOE). A LCOE calculation takes total installation costs, incentives, annual costs such as maintenance and financing costs, and system energy output, and calculates a net present value \$/kWh for electricity which can be compared to current retail prices. A simple payback calculation involves the same analysis conducted for year 1, and calculates the first year costs divided by first year energy savings to see how long it will take for the investment to pay for itself. Navigant has used LCOE and payback analyses to examine consumer decisions as to whether purchase of distributed resources makes economic sense for these customers, and then projects DG penetration based on these analyses.

1.2 Report Organization

The remainder of this report is organized as follows:

- Distribution Generation Technology Definitions
- Resource Cost & Performance Assumptions
- DG Market Potential and Barriers
- Market Barriers to DG
- Methodology to Develop 2015 DG Penetration Forecasts

⁴ Fisher-Pry are researchers who studied the economics of “S-curves”, which describe how quickly products penetrate the market. They codified their findings based on payback period, which measures how long it takes to recoup initial high first costs with energy savings over time.

- Results
- Appendix A: Glossary.

2. DG Technology Definitions

2.1 What is a “Distributed Generation” Source?

Distributed generation (DG) sources provide on-site energy generation and are generally of relatively small size, usually no larger than the amount of power used at a particular location.

2.1.1 Size Limits for this Study

For this study, the DG resources must meet the size requirements for net metering for the six states of PacifiCorp’s service territory, as installations that take into account net metering benefits are likely to be most economical. These size requirements are generally less than 2 MW, per Table 2-1 below.

Table 2-1. PacifiCorp Net Metering Limits

State	Net Metering Size Limits	CHP?	Net Metering Credits ⁵	Source
CA ⁶	1 MW, unless university/local government owned (5 MW)	N	Retail rate ⁷	http://www.cpuc.ca.gov/PUC/energy/DistGen/netmetering.htm
ID ⁸	100 kW non-residential 25 kW res / small commercial	N	Retail rate for residential / small commercial 85% avoided cost rate for all others	http://www.rockymountainpower.net/env/nmcg.html
OR ⁹	2 MW non-residential 25 kW residential	N	Retail rate	OR Revised Statues 757.300; Or Admin R. 860-039; OR Admin R. 860-022-0075
UT ¹⁰	2 MW non-residential 25 kW residential	Y	<ul style="list-style-type: none"> • Retail rate for residential/ small commercial • Large commercial/ industrial with demand charges choose between avoided cost rate or alternative rate (FERC Form No. 1) 	http://energy.utah.gov/funding-incentives/
WA ¹¹	100 kW	Y	Retail rate	<u>Rev. Code Wash. § 80.60</u>
WY ¹²	25 kW	N	Retail rate	http://psc.state.wy.us/

⁵ The NEM credit for DG generation used to nullify or offset purchases from the utility.

⁶ <http://www.cpuc.ca.gov/PUC/energy/DistGen/netmetering.htm>

⁷ The rate block of the energy component of retail rates that the DG customer is able to avoid paying as a result of each kWh of DG production to which NEM applies.

⁸ <http://www.rockymountainpower.net/env/nmcg.html>

⁹ OR Revised Statues 757.300; Or Admin R. 860-039; OR Admin R. 860-022-0075

¹⁰ http://www.energy.utah.gov/renewable_energy/renewable_incentives...

¹¹ Rev. Code Wash. § 80.60

Net Metering applies to all DG technologies under consideration, with the possible exception of combined heat and power (CHP), as notated in Column 3 of Table 2-1.

2.1.2 Determination of Applicable Technologies

Technologies considered for this study include commercialized technologies that are generally installed in system sizes smaller than the net metering limits designated in Table 2-1, with a focus on technologies that are achieving market penetration in PacifiCorp’s service territory (namely solar and wind). Table 2-2 below lists potentially applicable technologies, which ones were included (those in grey), and the reasons why a number of technologies were not included at this time. Note, future IRP’s may include consideration of more technologies, especially those upon the cusp of commercialization (such as fuel cells), but resource constraints excluded them at present. Nevertheless, we believe we have captured the major trends and DG technologies that will impact PacifiCorp over the next decade, as newer technologies will take a long time to overcome commercialization challenges and significantly penetrate the market.

Table 2-2. Applicable DG Technologies

Distributed Generation Technology		2013 Net Meter Customers	Included in this DG Study?	Comment
Photovoltaic		~94%	Yes	Highest level of DG market penetration
Small Scale Wind		~6%	Yes	Technical potential is potentially high, especially in WY
Small Hydro			Yes	Technical potential is relatively high in the Pacific Northwest
CHP [Identified in 2013 IRP CHP Memo]	Reciprocating Engines		Yes	Largest market penetration, commercial technology
	Micro-turbines		Yes	Newer technology
	Natural Gas Turbines		No	Turbine sizes generally larger than 2 MW
	Fuel Cells		No	Non-commercial with limited market penetration
	Industrial Biomass		No	Large scale, does not apply to DG
	Anaerobic Digester (AD) Biogas		No	Similarly, AD is not generally economic on a small scale
Solar Hot Water [see 2013 IRP SHW Memo]			No	Solar Hot Water is included in the Demand Side Management study

¹² <http://psc.state.wy.us/>

2.1.3 Solar DG Technology Definition

There are primarily two methods of converting sunlight into electricity: solar electric (photovoltaic), and solar thermal. These are depicted below in Figure 2-1.

Figure 2-1. Solar Technology Types

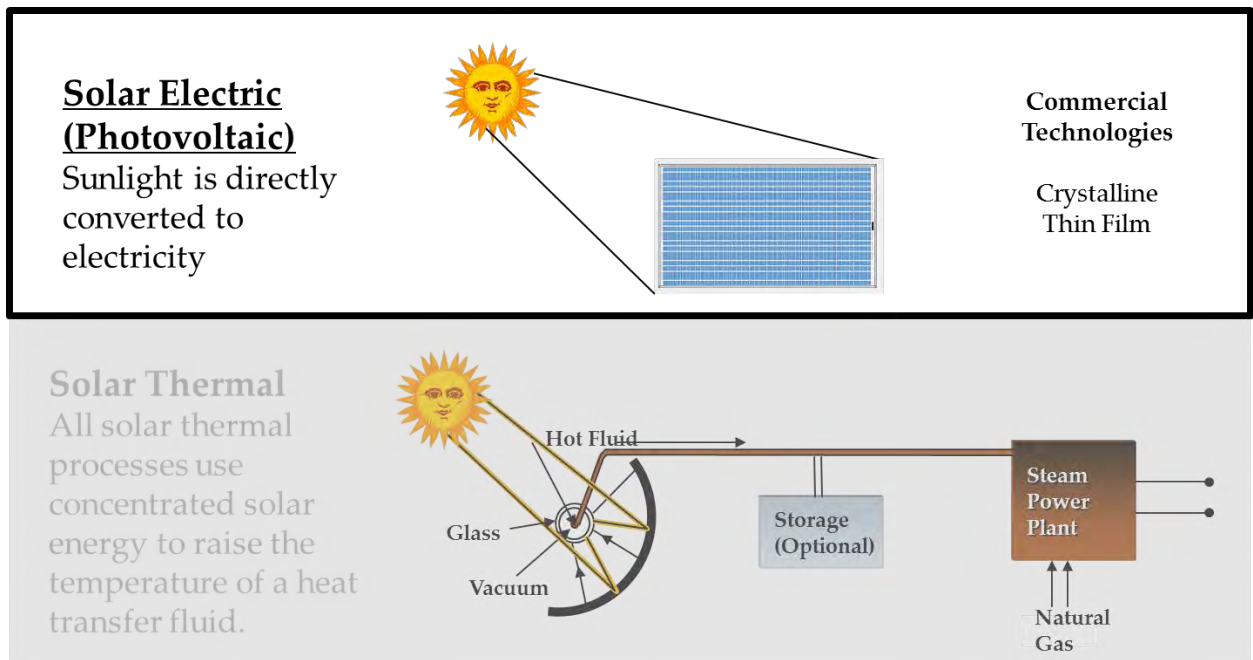

Solar thermal technologies, which concentrate energy to raise the temperature of a heat transfer fluid, usually require system sizes of 50MW or higher to be economical, so we have excluded them from further consideration.

Commercialized solar electric technologies include crystalline silicon (~90% of the market), and thin film (~10% of the market). Other solar technologies include concentrating photovoltaics (CPV), and photovoltaics with tracking.

For purposes of this study, we define photovoltaics to be crystalline or thin film module technologies that are mounted at either a fixed angle (usually 30-45 degrees) to a pitched roof, or mounted at a fixed angle (usually 5-10 degrees) on a flat rooftop, as most “less than 2 MW” applications are typically rooftop mounted. Concentrating photovoltaic technologies are currently uneconomic, with little market penetration, and tracking technologies are used mostly on large-scale fields (>2 MW project scale).

Photovoltaics can be used at many system sizes and voltages, sometimes called applications (see Figure 2-2 below). For purposes of this study, we are considering grid-connected applications only, as PacifiCorp is interested in the distributed resources that will impact future resource decisions, and off-grid applications are by definition not connected to PacifiCorp’s electrical grid. In addition, we exclude large central/substation applications that operate at transmission voltages because these projects are

almost all done at larger than 2 MW scale, the net metering limit. This excludes a few large industrial rate consumers from this study.

Figure 2-2. PV System Applications

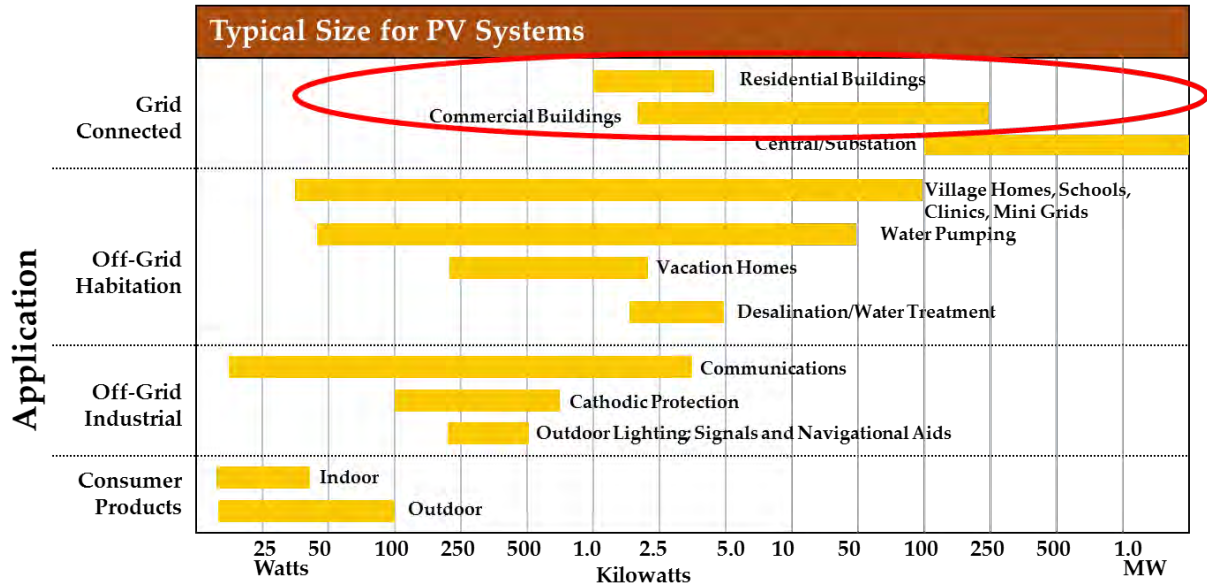

Central / Substation applications, at transmission voltages, are excluded because these projects are almost all at larger scale than 2 MW, the net metering limit.

2.1.4 Small Distributed Wind Technology Definition¹³

Wind technologies produce electricity by using a tower to hold up a multi-bladed structure. Wind spins the blades and generated power in a wind turbine. Sizes can range from very large structure (100's of feet tall), to much smaller (10s of feet tall), as shown in Figure 2-3.

Figure 2-3. Wind Turbine Examples

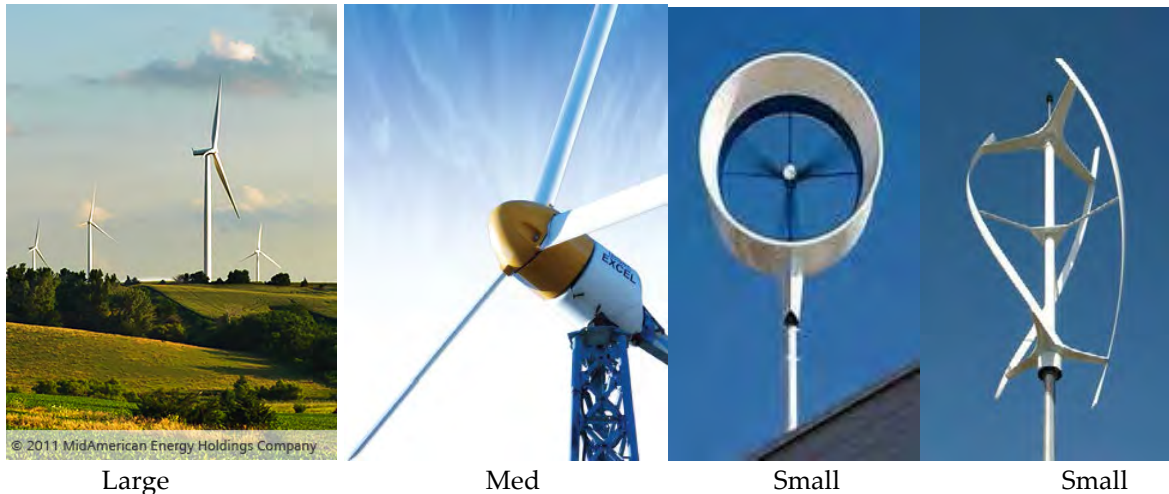

Small wind systems are most commonly defined as those with rated nameplate capacities between 1 kW and 100 kW; however, some groups include small wind turbines (SWT) of up to 500 kW in that category. For purposes of keeping power classes consistent when comparing historical and forecast annual installed data, Navigant uses the range of SWTs less than 100kW, unless otherwise noted. The primary focus of this report is on-grid-connected systems, as these systems will impact PacifiCorp's future load. A small wind system consists of, as necessary, a turbine, tower, inverter, wiring, and foundation, and these systems can be used for both grid-tied and off-grid applications. Micro-wind is a subset of the small wind classification and is generally defined as turbines of less than 1 kW in capacity. These units are typically used in off-grid applications such as battery charging, providing electricity on sailboats and recreational vehicles, and for pumping water on farms and ranches. We consider micro-wind applications to be a part of the small wind residential segment.

Community wind is another distributed wind category; it is typically a larger-scale project that includes one or several medium- to large-scale turbines to create a small wind farm with total capacity in the range of 1 MW to 20 MW. In this arrangement, the wind farm is at least majority-owned by the end users. Community wind projects in Minnesota and Iowa, for example, have utilized 1 MW-plus turbines. For comparison, community wind installations made up approximately 5.6% of total U.S. installed wind capacity in 2010 and 6.7% in 2011. However, because community wind projects tend to be on the large size, over the above net meter limits, these projects are considered to be part of the large wind market, and are not considered DG.

¹³ Note, this section is taken from "Small Wind Power: Demand Drivers, Market Barriers, Technology Issues, Competitive Landscape, and Global Market", a Navigant Research report, 1Q 2013, by Dexter Gauntlett and Mackinnon Lawrence.

Overall, small wind represents far less than 1% of U.S. annual installed wind capacity. Small wind turbines (SWT) are classified as either horizontal-axis or vertical-axis. Horizontal-axis wind turbines (HAWTs) must be installed at a height of 60 ft. to 150 ft. (usually on a tower) in order to access sufficient unhindered wind to be efficient. They can also be installed atop tall buildings. Unlike HAWTs, vertical-axis wind turbines (VAWTs) are designed to utilize more turbulent wind patterns such as those found in urban areas [an example of this type of turbine is shown at the far right of Figure 2-3]. VAWTs are associated with rooftop installations and are sometimes integrated into a building’s architecture. In general, VAWTs are much less efficient than HAWTs, but the actual output of any turbine depends on wind conditions at the site. Most experts agree that, in light of their economics and energy output, urban SWTs have yet to constitute a viable or sustainable market – at least with current designs. Table 2-3 illustrates common SWT applications based on turbine size. For this study, only the on-grid applications in blue are being modeled and considered further.

Table 2-3. Common Applications for Small Wind Systems

Rated System Power	Wind-diesel								Wind Mini-farm							
	Wind hybrid								Single Wind Turbine							
	Wind home system								Build Integrated							
< 1 kW	X	X	X	X	X	X	X		X	X	X	X				
1 kW- 7 kW	X	X	X	X	X	X	X	X		X	X	X	X	X	X	
7 - 50 kW					X	X	X	X	X		X	X	X	X	X	
50 - 100 kW								X	X				X	X	X	
Small wind applications	Sailboats	Signaling	Street lamp	Remote houses	Farms	Water Pumping	Seawater Desalination	Village Power	Mini-grid	Street Lamp	Building Rooftop	Dwellings	Public Centers	Car Parking	Industrial	Farms
	Off-grid									On-grid						

Another picture of how SWT size varies with application is shown in Figure 2-4 from a recent market survey conducted by Pacific Northwest Laboratory in 2013. Off-grid small turbines tend to be .1-9 kW in size; residential turbine sizes vary from 1-10 kW, mimicking residential loads; and commercial small wind markets use a broader 11-100 kW in turbine sizes. Note, also that the total small wind capacity additions for the country in 2012 was ~54 MW, which is relatively low compared to the over 13000 MW amount of total wind power installed in the US in 2012¹⁴.

¹⁴ 2012 Wind Technologies Market Report, US Department of Energy and Lawrence Berkeley Livermore Laboratory.

Figure 2-4. U.S. SWT Sales, by Market Segment (2007-2012)¹⁵

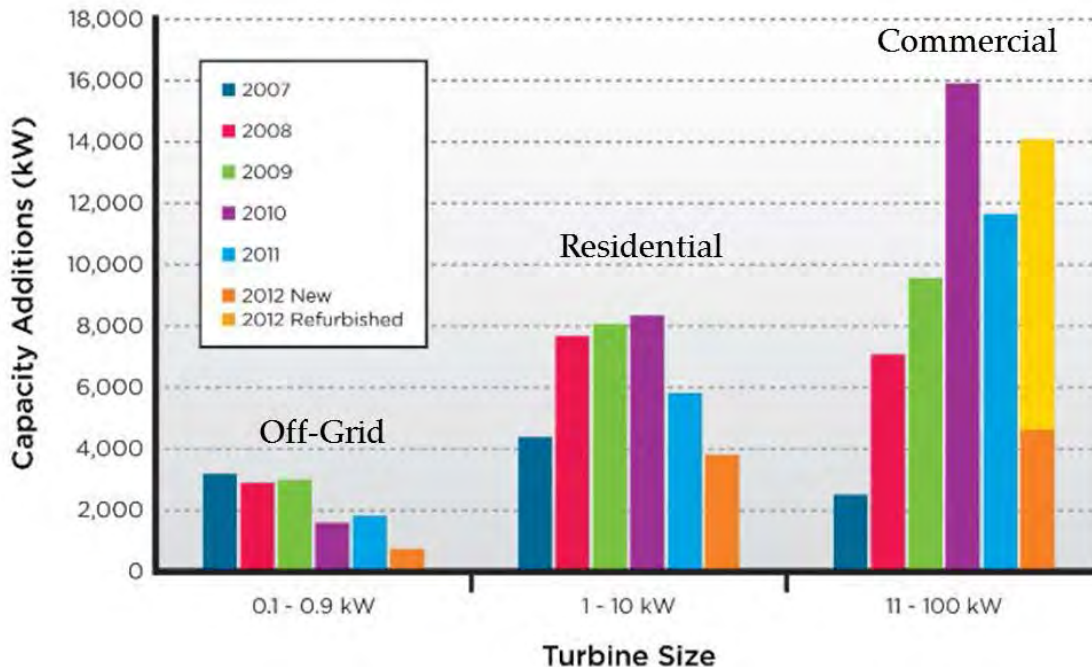

2.1.5 Small Scale Hydro Technology Definition

In assessing hydro potential, Navigant references a number of U.S. Department of Energy (DOE) reports that inventory the potential for small- and large-scale hydro:

- “Assessment of Natural Stream Sites for Hydroelectric Dams in the Pacific Northwest Region”, Hall, Verdin, and Lee, March 2012, Idaho National Laboratory, INL/EXT-11-23130
- “Feasibility Assessment of the Water Energy Resources of the United States for New Low Power and Small Hydro Classes of Hydroelectric Plants”, US Department of Energy, DOE-ID-11263, January 2006
- “Water Energy Resources of the United States with Emphasis on Low Head/Low Power Resources”, US Department of Energy, DOE.UD-11111, April 2004

The 2012 report details data for the Pacific Northwest Region, which covers Oregon, Washington, Idaho; the older report in 2006 represents the best information available for Utah, Wyoming, and California. DOE has also posted GIS software on-line for these hydro resources, especially the Pacific Northwest, which has the highest technical potential.

These reports define high power as > 1 MW, low power as < 1 MW, high-head as > 30 feet, and low head as < 30 feet. For the Pacific Northwest, we had access to the actual technical potential measurements by

¹⁵ 2012 Market Report on Wind Technologies in Distributed Applications, Aug 2013, Pacific Northwest National Laboratory, Orrell et al.

site, so defined small hydro as less than 2 MW, the net metering limit, to be consistent with the rest of the study.

As an example, Figure 2-5 shows the sites assessed in the Pacific Northwest, where each blue dot represents a potential site. The red zone below 2 MW represents our definition of small hydro for purposes of this study. It captures both high-head, low flow streams (i.e. large drops/waterfalls with small amounts of water), to low head, high flow streams (i.e. small drops with large amounts of water flowing), that each can add up to 2 MW of power produced annually. The studies examined estimated annual mean flow and power rates using state of the art digital elevation models and rainfall/weather records, and represent a maximum ideal power potential that may differ from specific site assessments that will include exact stream geometry, economic considerations, etc.

Figure 2-5. Small Hydro Definition¹⁶

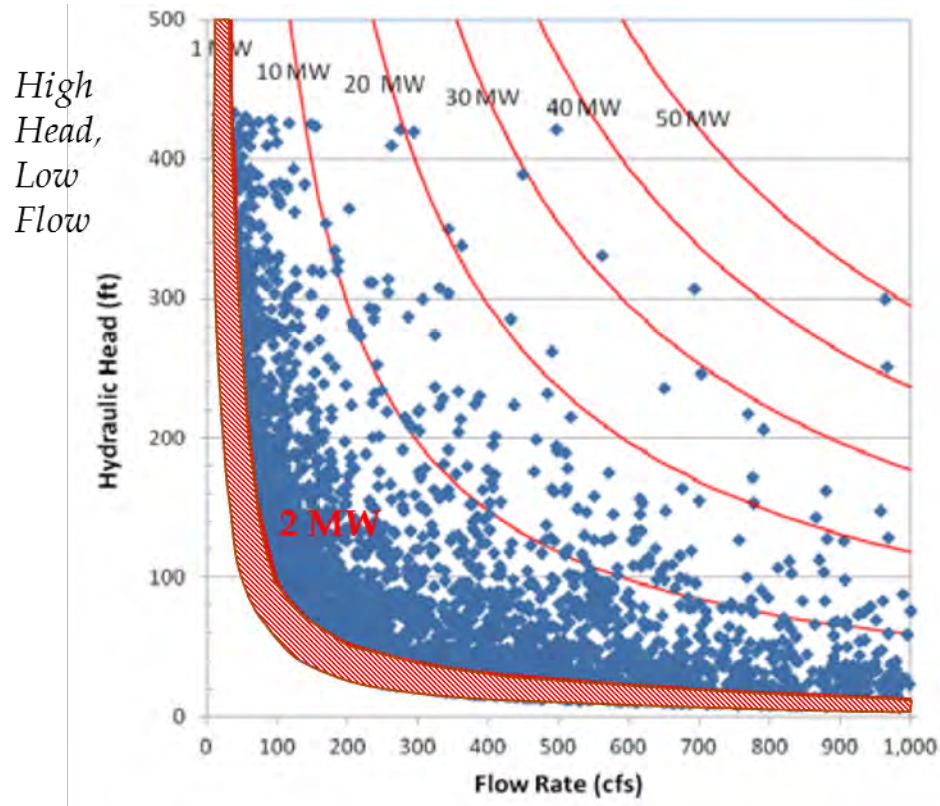

Figure 2-6 shows the hydraulic head vs. flow rates, and how these relate to conventional turbine designs, micro-hydro designs, and unconventional systems (ultra low head, kinetic energy turbines, etc.). Our study includes assessment of all of these technologies, as long as the estimated power produced annually is below 2 MW. Electric power is produced when water flows through a turbine, which spins a generator/alternator to generate electricity directly. See Figure 2-6 for an example site and a few representative turbine styles.

¹⁶ Figure 26, “Assessment of Natural Stream Sites for Hydroelectric Dams in the Pacific Northwest Region”, Douglas Hall, Kristine Verdin, Randy Lee, March 2012.

Figure 2-6. Small Hydro Sizes¹⁷

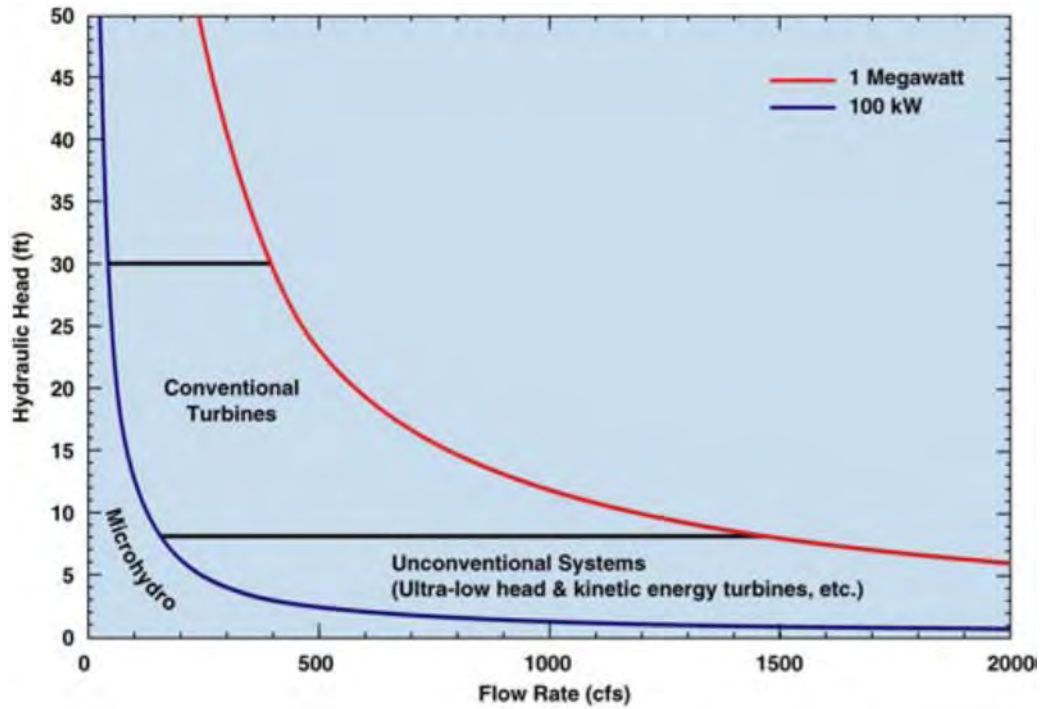

Figure 2-7. Example Small Hydro Sites, Turbines



¹⁷ Feasibility Assessment of the Water Energy Resources of the United States for New Low Power and Small Hydro Classes of Hydroelectric Plants, DOE-ID-11263, January 2006, US Department of Energy, page xviii.

2.1.6 CHP Reciprocating Engines Technology Definition

In a combined heat and power application, a small CHP power source will burn a fuel to produce both electricity and heat. In many applications, the heat is transferred to water, and this hot water is then used to heat a building (or sets of buildings, in the case of college or business campuses). The heat transfer fluid can also be steam, heating the building via radiators. Finally, in a factory setting the heat generated can be used directly in industrial processes (such a furnaces, etc.) Figure 2-8 and Figure 2-9 show example schematics for these systems.

Figure 2-8. Residential CHP Schematic¹⁸

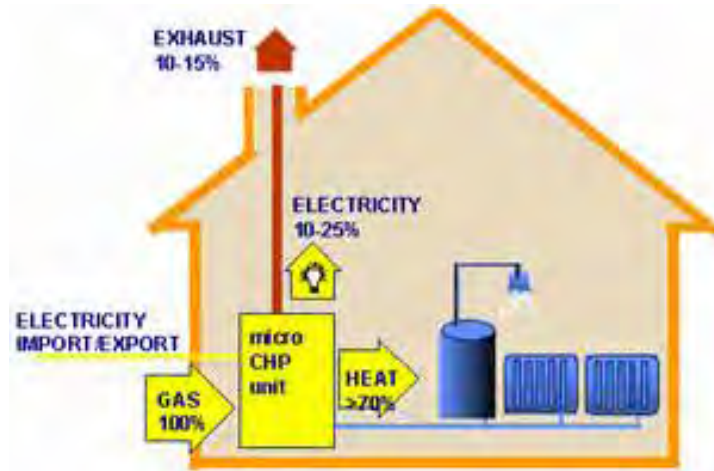
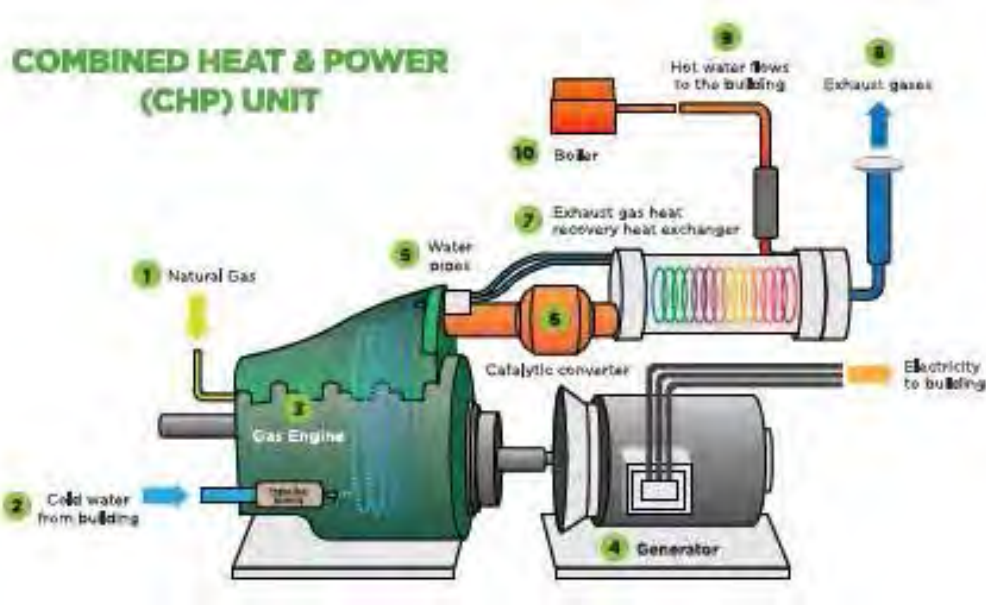

Figure 2-9. Typical Commercial CHP System Components¹⁹



The CHP source can be a large variety of possible devices; the most common on the market is an engine known as a “reciprocating engine.” As shown in Figure 2-10, a reciprocating engine is an internal combustion engine that uses pistons to turn a crankshaft that is connected to a generator used to produce electricity. Waste heat is extracted from the engine jacket and the exhaust gases to heat a building. This internal combustion engine is very similar to an automobile engine, but is typically somewhat larger.

¹⁸ <http://www.forbes.com/sites/williampentland/2012/03/04/japan-moves-the-needle-on-micro-chp/>

¹⁹ www.atcogas.com

Figure 2-10. Reciprocating Engine Cutaway²⁰

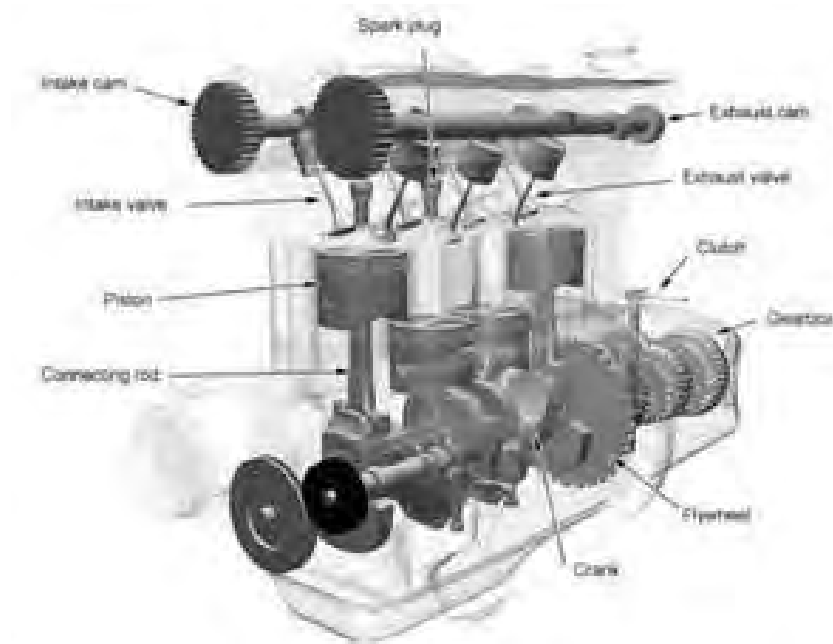

Navigant Research has done extensive surveys of diesel and gas-fired DG technology markets, and has found that ~80% of reciprocating engine sales are estimated to be for portable (i.e. for construction) and/or backup power applications²¹. For purposes of this study, these two applications are excluded because neither application would provide base-load power for PacifiCorp. Our main focus is therefore on the applications shown in Figure 2-11, namely base-load power applications and CHP applications.

²⁰ a2dialog.wordpress.com

²¹ "Diesel Generator Sets: Distributed Reciprocating Engines for Portable, Standby, Prime, Continuous, and Cogeneration Applications", 1Q2013, Dexter Gauntlett, Navigant Research.

Figure 2-11. Diesel/Gas-Fired DG Technology Applications

Applications and Markets for Diesel and Gas-Fired DG Technologies							
DG Technology	Standby Power	Baseload Power Only	Demand Response Peaking	Customer Peak Shaving	Premium Power	Utility Grid Support	Combined Heat & Power (CHP)
Reciprocating Engines (50 kW – 5 MW)	✓	✓	✓	✓	✓	✓	✓
Gas Turbines (500kW-50 MW)		✓		✓	✓	✓	✓
Steam Turbines (500kW-100 MW)		✓			✓		✓
Microturbines (30 kW – 250 kW)	✓	✓	✓	✓	✓	✓	✓
Fuel Cells (1 kW-2 MW)		✓			✓	✓	✓

Similar surveys show that reciprocating engines come in a large variety of sizes, and that natural gas fuels are typically in use ~ 11% of the time. We assume that diesel and gasoline fuels will be used in portable and/or remote backup situations, excluding these installations.

Figure 2-12. Reciprocating Engine Sizes and Fuels Used

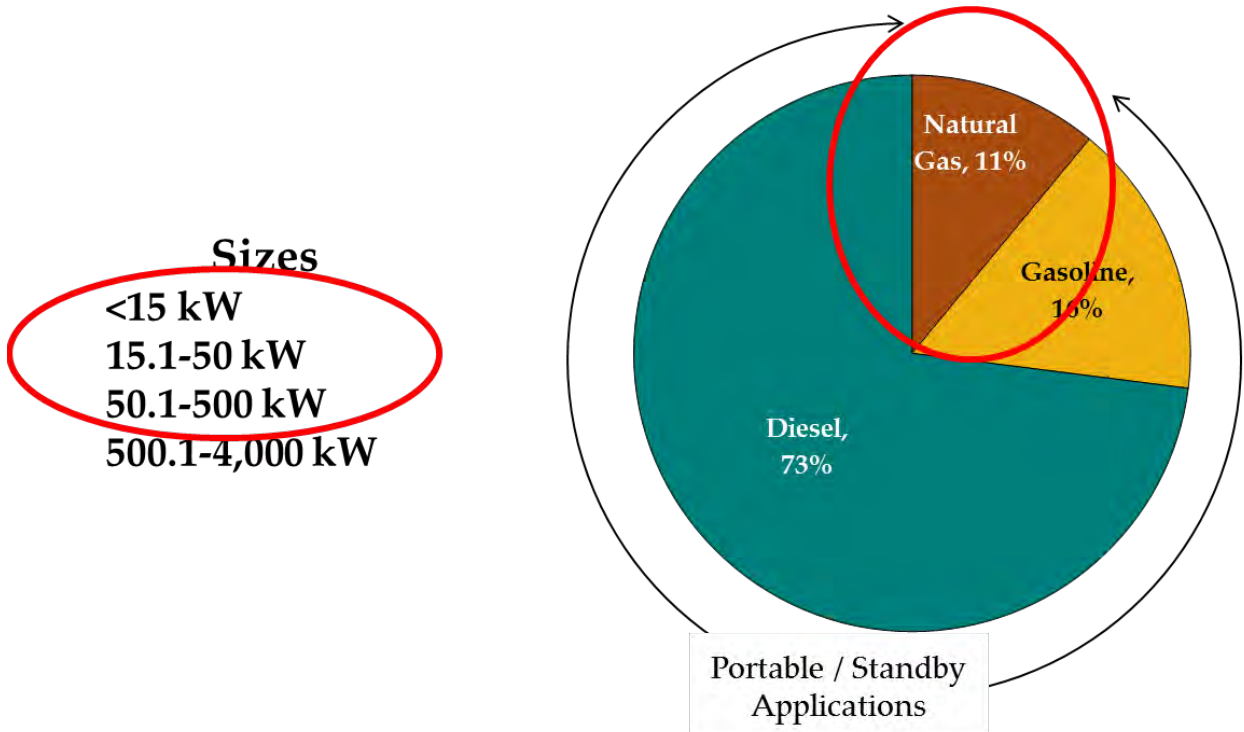

2.1.7 CHP Microturbine Technology Definition

The definition for the microturbine category is equivalent to that for reciprocating engines above, except that the CHP source is a microturbine rather than a reciprocating engine. A schematic of this type of device is shown in Figure 2-13.

Figure 2-13. Microturbine Schematic²²

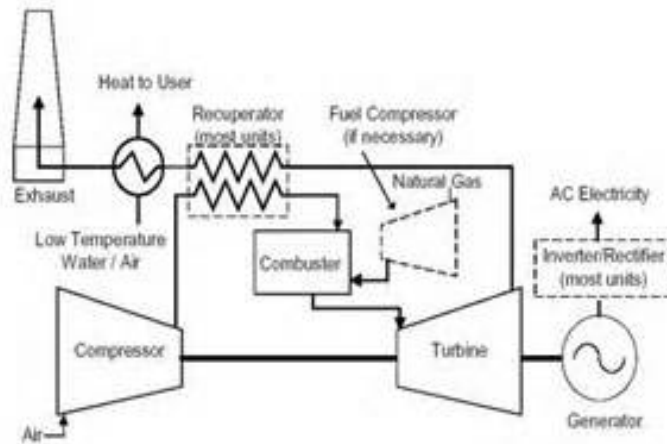

The microturbine uses natural gas to start a combustor, which drives a turbine. The turbine, in turn drives an AC generator and compressor, and the waste heat is exhausted to the user. The device therefore produces electrical power from the generator, and waste heat to the user. Emissions tend to be very low, allowing installation in locations with strict emissions controls, and they tend to have fewer moving parts than reciprocating engines, which they compete with directly in various applications.

Navigant used the performance specifications of a typical microturbine design as profiled in various market reports^{23,24}. Figure 2-14 shows one example offering.

Figure 2-14. Example Micro-turbines (Capstone Turbine Corporation)

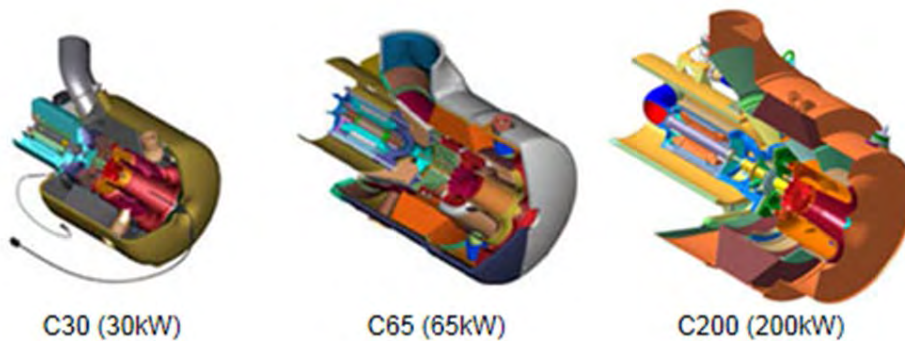

²² www.understandingchp.com

²³ "Catalog of CHP Technologies", U.S. Environmental Protection Agency, December 2008

²⁴ "Combined Heat and Power: Policy Analysis and Market Assessment 2011-2030", ICF, February 2012

3. Resource Cost & Performance Assumptions

3.1 Photovoltaic

3.1.1 Performance

Navigant has based its assessment of photovoltaic performance over time on manufacturer specification sheets and warranties. In general, solar panels are sized for either one or two man installation and handling, to allow them to fit them easily onto racks that are mounted onto rooftops, and that are of a weight and size for easy handling. For rooftop applications in particular, solar panels typically have an aluminum frame around the panel, to protect against accidental corner breakage and chipping of the front glass.

Figure 3-1. Example Solar Panels: Mono-crystalline and Poly-crystalline



The amount of power generated by the solar cell module depends on the particular material and configuration of the technology, as well as local sunlight conditions.²⁵ Figure 3-2 illustrates a typical crystalline technology cross section, showing the grid pattern (the fine lines in Figure 3-1), and the various electrical components of the cell. Over time, manufacturers have improved material quality,

²⁵ Navigant also factored in assumptions on single or dual axis tracking and the panel's orientation.

material types, processes, and optics to generate slightly more power in the same area. For mature technologies, these gains have been on the order of .1% / year for mainstream commercial cells²⁶.

Figure 3-2. Typical Crystalline Solar Cell Cross Section

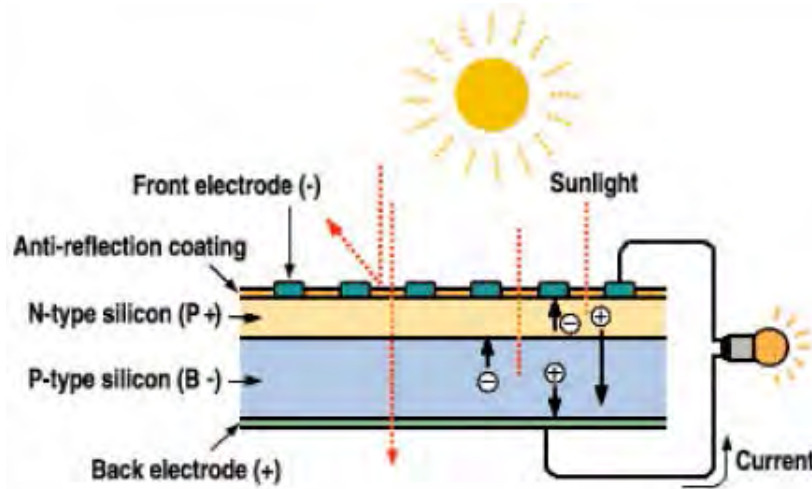

A photovoltaic module will experience some slight amount of degradation over time, as the wires in the cells age and oxidation increases resistance, as differential thermal expansion ages the cells, etc. In the industry, it is an industry standard to offer a limited power output warranty which covers this degradation. An example warranty is shown in Figure 3-3.

Figure 3-3. Example Solar Module Power Warranty

b) 25 Year Limited Power Output Warranty

In addition, Trina Solar warrants that for a period of twenty-five years commencing on the Warranty Start Date loss of power output of the nominal power output specified in the relevant Product Data Sheet and measured at Standard Test Conditions (STC) for the Product(s) shall not exceed:

- For Polycrystalline Products (as defined in Sec. 1 a): 2.5 % in the first year, thereafter 0.7% per year, ending with 80.7% in the 25th year after the Warranty Start Date,
- For Monocrystalline Products (as defined in Sec. 1 b): 3.5 % in the first year, thereafter 0.68% per year, ending with 80.18% in the 25th year after the Warranty Start Date.

In summary, we assume .1% efficiency gains over the next 20 years, mimicking solar technology performance over the last 20 years; and assume a .7% annual degradation rate in keeping with current module warranties that guarantee 80% power after 25 years.

²⁶ Based on February Photon International’s annual survey of PV module specification sheets over the last twenty years.

3.1.2 Cost

Amalgamating a number of public sources of data regarding PV installed and maintenance costs with our own private sources and internal databases, we used the following assumptions and sources for these costs:

Table 3-1. PV Installation and Maintenance Cost Assumptions

Photovoltaic				
DG Resource Costs	Units	Baseline 2013 (nominal \$)		Sources
		Residential	Commercial	
Installed Cost	\$/kW _{DC}	\$4000	\$3125	<ul style="list-style-type: none"> • Navigant Research market estimates • Photovoltaic System Pricing Trends: Historical, Recent, and Near - Term Projections, 2013 Edition, NREL/LBNL
Fixed O&M	\$/kW-Yr	\$23	\$25	<ul style="list-style-type: none"> • Navigant Research market estimates • Addressing Solar Photovoltaic Operations and Maintenance Challenges, 2010, EPRI • True South Renewables, Solar Plaza O&M Meeting 2014

Module prices have come down dramatically over the last few decades, as the brown line shows in Figure 3-4. This has impacted system prices sharply, as module price has traditionally been ~50% of total system price.

Figure 3-4. Photovoltaic Module Price Trends²⁷.

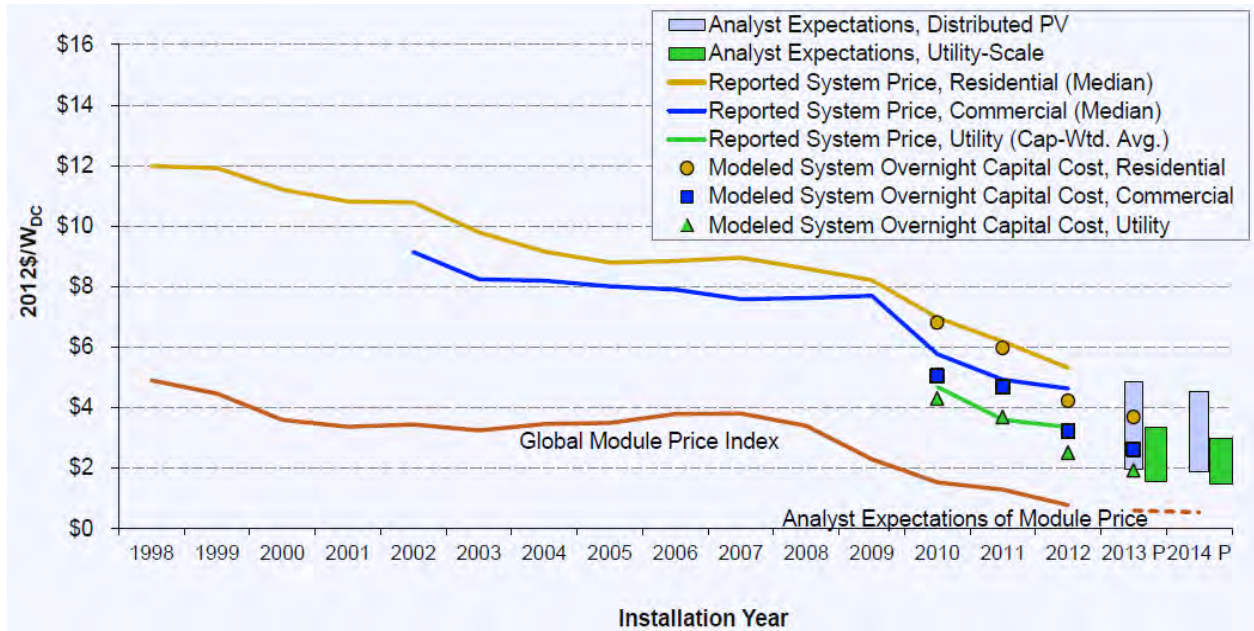

In our base case, Navigant assumes that PV annual system installation cost reductions will continue at the same rate as has occurred over the last ten years. Plotting the data from the above graph, this equals 4.7% cost reduction annually for commercial installations, and slightly higher 5.3% cost reduction for residential installations. Note, a higher proportion of installation costs have become non-module costs (installation labor, design, permitting, etc.) recently, and the U.S. is a relatively immature market relative to scale regarding these non-module factors. Our expectation is that these non-module costs will start to mimic more mature markets such as Germany where costs are demonstrably lower²⁸.

However, costs likely cannot be reduced at such a relatively high rate forever. Navigant assumes that DOE's modeled System Overnight Capital Cost will form a floor for future PV system prices, reaching 1.80 \$/WpDC (commercial), and 2.10 \$/WpDC (residential). For our high and low penetration cases, we vary these cost projections by +/- 10%.

²⁷ Photovoltaic System Pricing Trends: Historical, Recent, and Near-Term Projections, 2013 Edition",Feldman et al, NREL/LBNL, PR-6A20-60207

²⁸ "Why are Residential PV Prices in Germany So Much Lower Than in the United States?" A Scoping Analysis", Joachim Seel, Galen Barbose, and Ryan Wiser, Lawrence Berkeley National Laboratory, Feb 2013, sponsored by SunShot, US Department of Energy.

3.2 Small-Scale Wind

3.2.1 Performance

Large-scale wind has dramatically improved system capacity factor over 10% over the last two decades²⁹. This has reflected larger and larger turbine sizes, improvements in air flow modeling, blade angle control, indirect to direct drive innovations, etc. Small wind suffers from (a) size limitations, and (b) wind strength close to the earth tends to be much lower, Navigant assumes small wind system performance improvements will be roughly half of those achieved by its bigger cousins to reflect these factors and physical limits. We therefore assume that capacity factors will change from around 20% in 2013 to approximately 33% in 2034.

3.2.2 Cost

The most recent public cost data that we could find regarding small wind installed cost and maintenance costs are shown in Table 3-2:

Table 3-2. Small Scale Wind Cost Assumptions

Small Scale Wind			
DG Resource Costs	Units	Baseline 2013 (nominal \$)	Sources
Installed Cost (Residential)	\$/kW	\$6960	Capacity weighted average, "2012 Market Report on Wind Technologies in Distributed Applications." Pacific Northwest National Laboratory for U.S. DOE, August 2013. Commercial estimates based on reduced project costs.
Installed Cost (Commercial)		\$5568	
Fixed O&M	\$/kW-Yr	\$30	"2012 Market Report on Wind Technologies in Distributed Applications." Pacific Northwest National Laboratory for U.S. DOE, August 2013

The above capacity factor improvement is equivalent to a cost reduction potential of -2.5 % annual cost improvement over the next 20 years. If small wind gets to much larger scale than at present, then further cost reductions may be possible, but currently paybacks for this technology are very long, so this is less likely, and we therefore include this possibility as part of our high penetration scenario only.

²¹ "Recent Developments in the Levelized Cost of Energy from U.S. Wind Power Projects", Wiser et al, Feb 2012, National Renewable Energy Laboratory / Lawrence Berkeley National Laboratory. Contract No DE-AC02-05CH11231.

3.3 Small-Scale Hydro

3.3.1 Performance

Hydropower project capacity factor can vary widely, as Figure 3-5 illustrates. Navigant assumes 50% capacity factor in the base case as typical³⁰, using a band of +/- 5% to capture the variation in average project capacity factor as part of its low and high penetration scenarios.

Figure 3-5. Hydropower project capacity factors in the Clean Development Mechanism³¹

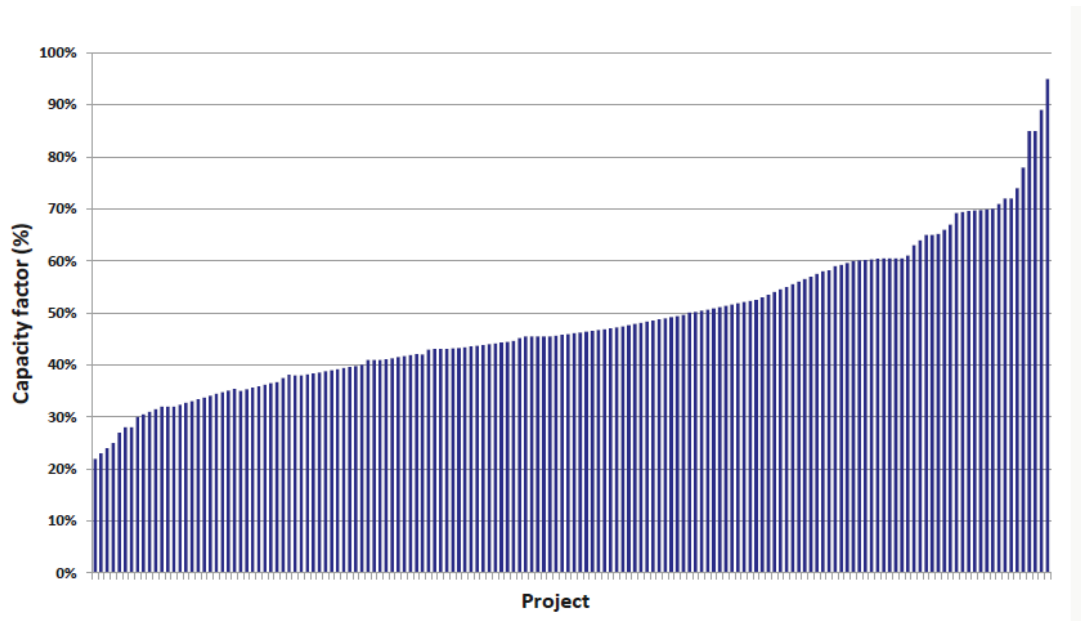

³⁰ This datapoint of 50% is echoed in three DOE potential studies referenced in section 2.1.7 .

³¹ Renewable Energy Technologies: Cost Analysis Series, Volume 1: Power Sector, Issue 3/5, Hydropower, June 2012, International Renewable Energy Agency, Figure 2.4, which references E. Branche, "Hydropower: the strongest performer in the CDM process, reflecting high quality of hydro in comparison to other renewable energy sources, EDF, Paris, 2011.

3.3.2 Cost

Cost data for small scale hydro is found in Table 3-3, with the sources annotated. In keeping how other mature technologies are treated in the IRP, Navigant assumes no further future cost improvements for this technology.

Table 3-3. Small Scale Hydro Cost Assumptions

Small Scale Hydro			
DG Resource Costs	Units	Baseline 2013 (nominal \$)	Sources
Installed Cost	\$/kW	\$4000	Double average plant costs in "Quantifying the Value of Hydropower in the Electric Grid: Plant Cost Elements." Electric Power Research Institute, November 2011; this accounts for permitting/project costs
Fixed O&M	\$/kW-Yr	\$52	Renewable Energy Technologies: Cost Analysis Series. "Hydropower." International Renewable Energy Agency, June 2012.

3.4 CHP Reciprocating Engines

3.4.1 Performance

Reciprocating internal combustion engines are a widespread and well-known technology. There are several varieties of stationary engine available for power generation market applications and duty cycles. Reciprocating engines for power generation are available in a range of sized from several kilowatts to over 5 MW. We used an electric heat rate of 11,000 Btu/kWh corresponding to electrical efficiencies around 30%-33%.

3.4.2 Cost

The latest cost data for CHP reciprocating engines is shown in Table 3-4.

Table 3-4. CHP Reciprocating Engines Cost Assumptions

CHP Reciprocating Engines			
DG Resource Costs	Units	Baseline 2013 (nominal \$)	Sources
Installed Cost	\$/kW	\$2325	Combined Heat and Power: Policy Analysis and Market Assessment 2011-2030, ICF International; Catalog of CHP Technologies, U.S. Environmental Protection Agency and Combined Heat and Power Partnership; Navigant market research
Annual Cost Reductions	%	-1.4%	20% by 2030; "Combined Heat and Power: Policy Analysis AND 2011-2030 Market Assessment." ICF International, Inc., February 2012. CEC-200-2012-002.
Variable O&M	\$/MWh	\$19	Catalog of CHP Technologies, 2008, U.S. Environmental Protection Agency
Fuel Cost	\$/MWh	\$77 [UT]	Example State: UT; Electric Heat Rate: 11,000 BTU/kWh; Fuel Cost: ~\$6.90/MMbtu*. Note, these are retail costs, not wholesale.

3.5 CHP Micro-turbines

3.5.1 Performance

Micro-turbines are small electricity generators that burn gaseous and liquid fuels to create high-speed rotation that turns an electrical generator. The capacity for micro-turbines available and in development is generally from 30 to 250 kilowatts (kW). We assumed electric heat rate around 14,800 Btu/kWh used which corresponds to a thermal to electric efficiency around 23%-25%. The electrical efficiency increases as the microturbine becomes larger.^{23,24}

3.5.2 Cost

Table 3-5 shows the latest cost data and assumptions for micro-turbines.

Table 3-5. CHP Microturbine Cost Assumptions

CHP Micro-turbines			
DG Resource Costs	Units	Baseline 2013 (nominal \$)	Sources
Installed Cost	\$/kW	\$2650	Combined Heat and Power: Policy Analysis and Market Assessment 2011-2030, ICF International; Catalog of CHP Technologies, U.S. Environmental Protection Agency and Combined Heat and Power Partnership; Navigant market research
Annual Cost Reductions	%	-1.4%	20% by 2030; "Combined Heat and Power: Policy Analysis AND 2011-2030 Market Assessment." ICF International, Inc., February 2012. CEC-200-2012-002.
Variable O&M	\$/MWh	\$23.5	Catalog of CHP Technologies, 2008, U.S. Environmental Protection Agency
Fuel Cost	\$/MWh	\$104 (UT)	State: UT; Electric Heat Rate: 14,800 BTU/kWh; Fuel Cost: ~\$6.90/MMbtu*

4. DG Market Potential and Barriers

A number of DG resources are more expensive than grid electricity to the consumer on a levelized cost of energy basis. As a result, there are various forms of incentives that close the “grid parity gap” for some DG technologies.

4.1 Incentives

4.1.1 Federal Incentives

A primary incentive, which Congress allows for wind and solar DG technologies, is the federal Business Energy Investment Tax Credit (ITC), which allows the owner of the system to claim a tax credit off a certain percentage of the installed price of these distributed generation resources.³² For example, for solar PV technologies the ITC is currently 30% of the overall installed system cost. This ITC for solar PV is set to reduce from 30% down 10% at the end of 2016. For CHP reciprocating engines and CHP microturbine technologies, the ITC for businesses is 10%. An equivalent personal credit is given for residential customers.

For our base case analysis, Navigant presumes that aside from the expiration of the 30% ITC incentive down to 10% in 2017, current regulatory incentives will continue throughout the analysis period. In general, due to the uncertainties associated with varying political policy over time, Navigant does not attempt to predict whether or when particular policies will be enacted, and assumes that existing policy applies. Our base case therefore includes all current incentives, including expiration dates. Our high and low cases explicitly model potential changes in technology cost assumptions, technology performance assumptions, and future electricity rate assumptions, as discussed below. Policy changes that have equivalent payback impacts are therefore also modeled as part of our high and low scenarios. In other words, if the high penetration case includes 10% steeper cost reductions / year, and incentives are offered that are equivalent to this level of cost reduction, our high case includes this type of policy change (whether due to a policy change, or steeper cost reductions than expected).

4.1.2 State Incentives

State incentives within PacifiCorp’s service territory that apply to the technologies under consideration in sizes < 2 MW are shown below in Table 4-1.

³² www.dsireusa.org

Table 4-1. State Tax Incentives³³

	Personal Tax Credit (residential)	Corporate Tax Credit	Sales Tax
CA			100% to PV powered agricultural equipment
ID	PV/Wind: 40%/20%/20%/20% personal deduction, max \$5000		
OR	\$2.10/W-DC (PV), \$1500 max over 4 years Wind: \$2/kWh in first year, max \$1500 Hydro: \$.60/kWh saved		
UT	Res PV, Wind, Hydro: 25%, max \$2000 commercial PV, wind systems: 10% of installed cost, up to \$50,000 (<660 kW)		
WA			PV & Wind 100% (<10 kW); or 75% otherwise
WY			

As the table shows, there are a few state incentives that improve the payback and penetration of DG technologies beyond what is supported by the federal incentive. In particular, Oregon and Utah’s incentives significantly increase penetration. In general, depending on varying state goals and budgets, Navigant has observed that state incentives tend to complement or step up when federal incentives are reduced. Note as well that state incentives tend to be subject to varying budget restrictions over time and can therefore be somewhat volatile; this volatility can be lower for rate supported programs.

³³ See <http://www.dsireusa.org/summarytables/finre.cfm>. Incentives and Rebates were examined as of 06/01/14; note that not all incentives listed on the website apply due to 2 MW size restrictions, alternate technologies, etc.

4.1.3 Rebate Incentives

On top of state tax incentives, states or specific utilities within a state also offer rebates for DG installations. Typically these programs pay an up-front rebate to reduce the initial installation cost of the system, and are subject to strict budget limits. Rebate incentives that apply to PacifiCorp’s service territory are shown in Table 4-2:

Table 4-2. Rebate Incentives

	Rebates ³⁴
CA	Pacific Power PV Rebate Program: \$1.13/Wp CEC-AC Res \$.36/W CEC-AC Comm \$4.3 Million overall
ID	
OR	Oregon State Rebate Programs: Small Wind Incentive Program \$5.00/kWh, up to 50% of installed cost Solar Electric Incentive Program \$.75/WpDC (res) \$1.00 /Wp (0-35 kW); .45-\$1.00/Wp (35-200 kW) commercial \$7500 max 2014 budget in PacifiCorp territory: \$2 Million.
UT	Rocky Mountain Power PV Rebate Program: \$1.25->1.05/W-AC (res). \$1.00->.80/W-AC (0-25kW); \$.80->.60/W-AC (25-1000 kW) commercial Max: \$5000 (res). \$25,000 (0-25 kW). \$800,000 (25-1000 kW) \$50 million from 2013-2017
WA	
WY	

PacifiCorp is spending over \$50 million from 2013-2017 in California and Utah, supporting DG technologies, and Oregon state’s rebate program is spending ~\$2 million annually within PacifiCorp’s service territory. Given that these expenditures are rate-payer based, we assume the Oregon state rebate budget levels will extend throughout the IRP period as part of our base case.

³⁴ See <http://www.dsireusa.org/summarytables/finre.cfm>. Incentives and Rebates were examined as of 06/01/14; note that not all incentives listed on the website apply due to 2 MW size restrictions, alternate technologies, expiring CSI budgets, etc.

4.2 Market Barriers to DG Penetration

There are a number of market barriers to wider use of distributed resources in PacifiCorp's service territory. These include technical, economic, regulatory/legal, and institutional barriers. Each of these barriers is discussed in turn.

4.2.1 Technical Barriers

4.2.1.1 Maximum DG Penetration Limits

If DG sources are renewable, these usually have reduced availability / capacity factor when the resources is not available, and can also be highly variable.

Because no widespread cost-effective energy storage solutions exist, backup power generation is needed when variable sources are suddenly unavailable (i.e., storms blocking the sun, or the wind dies down suddenly). This, in turn, can increase costs. From a technical perspective, a number of jurisdictions (Germany, Denmark, other utilities in the US³⁵) have demonstrated that renewable sources can represent 20-30% of grid power without energy storage solutions. California is on target for reaching its 33% by 2020 renewable goal³⁶, while many other states in PacifiCorp's service territory have varying renewables penetration..

4.2.1.2 Interconnection Standards

Technical interconnection standards must be in place to ensure worker safety and grid reliability, and at the DG level these concerns have largely been addressed by standards such as IEEE 1547, which is concerned with voltage and frequency tolerances for distributed resources. Other technical codes and standards include ANSI C84 (voltage regulation), IEEE 1453 (flicker), IEEE 519 (harmonics), NFPA NEC / IEEE NESC (safety)³⁷.

However, as DG penetration levels increase to high levels (greater than 10%+), jurisdictions such as Germany have found that voltage control / ride-through can be an issue. Similarly, standards are a work in progress regarding advanced inverters and the grid support they can provide (reactive control, etc.). Finally, there is a lack of standards regarding utility two-way control of DG systems at high penetration levels. Two-way control, with attendant communication systems and higher costs, can allow the utility to turn off DG sources during periods of low load for better source/demand matching and dispatch. Standards bodies – IEEE, etc. – continue to make progress on defining these types of technical standards that will become more important should PacifiCorp face higher levels of DG market penetration.

From a practical perspective, there is a plethora of different technical ways to interconnect DG equipment to the grid, and parts/schematic standardization is helpful to reduce maintenance costs (training, spare parts inventories, etc.) and improve safety. As DG penetration increases, we expect PacifiCorp to examine these issues as necessary with larger amounts of DG penetration.

³⁵ On May 2013, Xcel Energy produced 60% of its power from wind. See http://www.xcelenergy.com/Environment/Renewable_Energy/Wind/Do_You_Know:_Wind

³⁶ See <http://www.energy.ca.gov/renewables/>

³⁷ "Interconnection Standards for PV Systems: Where are we? Where are we going?", Abraham Ellis, Sandia National Laboratory, Cedar Rapids, IA, Oct 2009.

4.2.2 Economic Barriers

4.2.2.1 Cost Barriers

DG sources tend to be more expensive than conventional sources due to a number of effects:

- **Site Project Costs:** Site project costs are spread out over smaller project sizes. For example, a 467 MW coal plant³⁸ compared to a 100kW PV commercial roof installation. Because site project costs are relatively constant, these costs are higher for the DG installation.
- **Efficiency:** DG sources tend to be less efficient than conventional sources (with CHP being the exception). Less power produced by a source leads to higher costs on a \$/kWh basis.
- **Technology scale:** As technologies move into mass production, equipment costs can come down dramatically; but until then, costs can be high, creating a barrier to market penetration. If a process is relatively slow, or expensive materials are used, this can result in high costs even at high scale.
- **DG Preferential Use:** If DG is used preferentially over conventional sources, conventional source power costs can increase due to more start-stops, or less efficient operation.

Each of these barriers is being address in the US market, varying by technology, and we therefore expect DG costs to come down over time, as shown above in our cost assumption for each technology. The US DOE is focusing research efforts on reducing soft costs, technical innovations can address efficiency gaps, and we expect many technologies to get to scale over the IRP period.

4.2.2.2 Resource Availability

DG sources are dependent on the availability of their respective resources, especially from an economic perspective. For example, a CHP project needs a large enough local thermal load to be economically attractive. Similarly, a small scale hydro project needs to have adequate water flow annually to generate enough power to be viable and a small wind project needs high enough wind speed (typically class 3 or 4) to be viable.³⁹ A solar project needs enough solar insolation to be worth developing in addition to appropriate rooftop orientation and rooftop area availability.

4.2.2.3 Trade Barriers/ Issues

There have been recent trade actions that have impacted the US market for PV modules, one DG technology. The US and the EU have levied trade sanctions and tariffs on to Chinese PV panel producers, increasing module costs in the U.S. Conversely, Chinese government subsidies resulted in a large overcapacity of module factories in China, and this has reduced prices dramatically over the last 5 years, as well as driven a number of US manufacturers out of business. Trade issues can therefore be both a barrier as well as a spur to DG market growth.

³⁸ A typical size for a coal plant (source: EIA)

³⁹ Class 3 wind has annual wind speeds of 11.5-12.5 mph; class 4 is 12.5-13.4 mph. (<http://trredc.nrel.gov/wind/pubs/atlas/tables/1-1T.html>)

4.2.3 Legal / Regulatory Barriers

4.2.3.1 Net Metering

All PacifiCorp states have approved net metering programs for DG as shown in Figure 4-1. The provisions of these programs vary by state. For customers owning DG, net metering can reduce the DG payback period, which may influence a customer’s investment decision. For customers leasing DG, it is uncertain whether and to what extent net metering has impacted the lease price offered to a customer and the total cost of a leasing customer’s total electric consumption.

Figure 4-1. Net Metering Policies in the U.S.⁴⁰

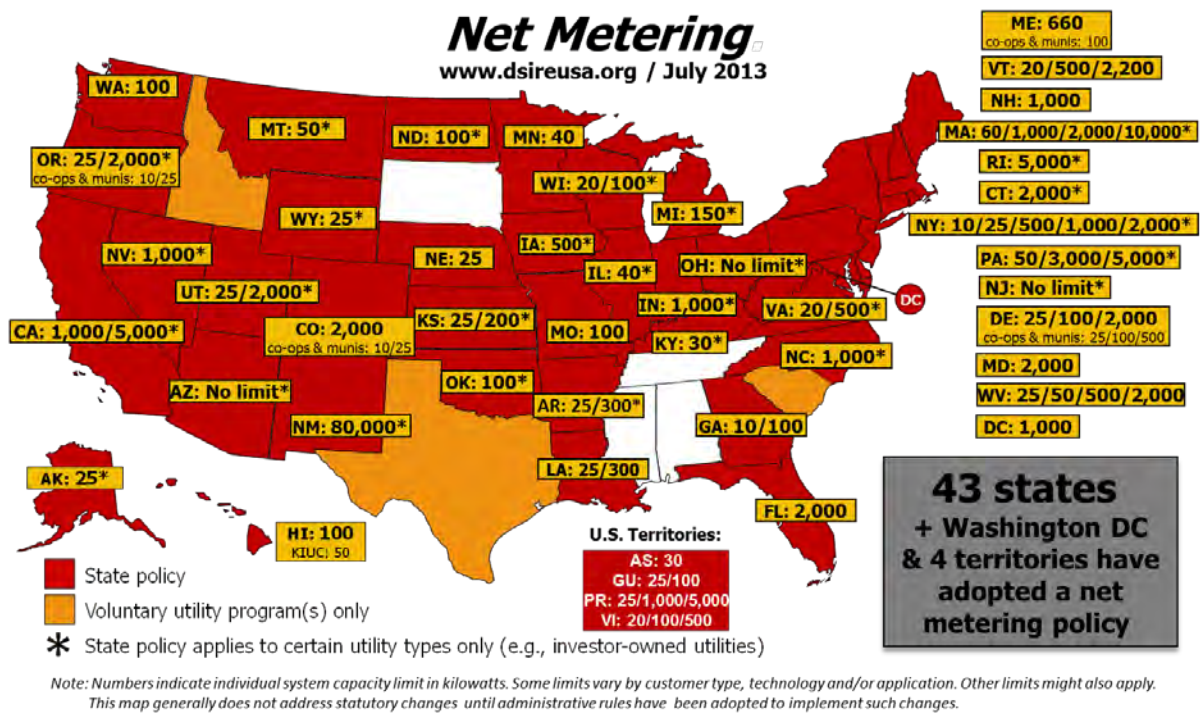

4.2.4 Institutional Barriers

Institutional barriers include mis-matched incentives and financing barriers.

4.2.4.1 Mis-matched Incentives

Typically, when a DG power source is purchased and installed, the benefits accrue directly to the customer rather than a utility. Utilities feel higher DG usage by customers as a drop in load and revenue, making it difficult for a utility to recover its fixed costs if actual sales in a 12-month period do not equal the forecast sales used in setting rates.

⁴⁰ www.dsireusa.org

4.2.4.2 Financing Barriers

As displayed in Figure 4-2, we are currently enjoying the lowest interest rates available in a generation.

Figure 4-2. US Benchmark Interest Rate⁴¹

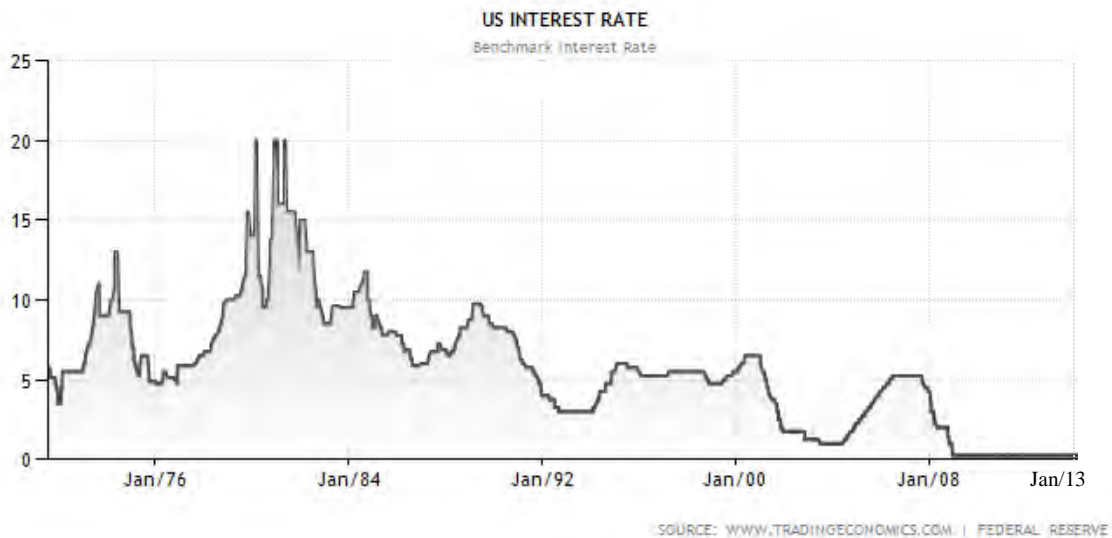

At some point, these interest rates may rise, significantly increasing the cost of financing DG projects, which typically have high up-front costs and use a loan and/or equity financing to enable projects to proceed. Countervailing this increasing interest rate possibility are trends regarding the risk premium for DG projects. As DG sources get to larger and larger scale from a financing perspective (i.e. deal size and bankability), the risk premium for these projects is likely to go down, especially for newer technologies. In particular, we are seeing solar projects shift from high equity content toward higher loan content, at correspondingly lower interest rates.

Current incentives tend to rely on ITC incentives, which require a healthy tax equity market for larger-scale project financing. A recent barrier to larger DG projects occurred when the tax equity appetite shrank dramatically during the recent financial crisis, slowing DG market growth. Congress reacted by creating the Treasury Grant program in response, but this took some time to get set up and operational.

⁴¹ <http://www.tradingeconomics.com/united-states/interest-rate>

5. Methodology to Develop 2015 IRP DG Penetration Forecasts

5.1 Market Penetration Approach

The following five-step process was used to determine the IRP penetration scenarios for DG resources:

1. **Assess a Technology's Technical Potential:** Technical potential is the amount of a technology that can physically be installed without taking economics into account.
2. **Calculate First Year Simple Payback Period for Each Year of Analysis:** From past work in projecting the penetration of new technologies, Navigant has found that Simple Payback Period is the best indicator of uptake. Navigant used all relevant federal, state, and utility incentives in its calculation of paybacks, including their expiration dates.
3. **Project Ultimate Adoption Using Payback Acceptance Curves:** Payback Acceptance Curves estimate what percentage of a market will ultimately adopt a technology, but do not factor in how long adoption will take.
4. **Project Actual Market Penetration Using Market Penetration Curves:** Market penetration curves factor in market and technology characteristics to project how long adoption will take.
5. **Project Market Penetration under Different Scenarios.** In addition to the Base Case scenario, a High Penetration and a Low Penetration case were evaluated that used different 20-year average cost assumptions, performance assumptions, and electricity rate assumptions.

Navigant examined the cost of electricity from the customer perspective, called "levelized cost of energy" (LCOE). A levelized cost of energy calculation takes total installation costs, incentives, annual costs such as maintenance and financing costs, and system energy output, and calculates a net present value \$/kWh for electricity which can be compared to current retail prices. A simple payback calculation involves the same analysis conducted for year 1, and calculates the first year costs divided by first year savings to see how long it will take for the investment to pay for itself. Navigant has used LCOE and payback analyses to examine consumer decisions as to whether purchase of distributed resources makes economic sense for these customers, and then projects DG penetration based on these analyses.

Each of these five steps is explained below.

5.1.1 Assess Technical Potential

Each technology considered has its own characteristics and data sources that influenced how we assessed technical potential, which is the amount of a technology that can be physically installed within PacifiCorp's service territory without taking economics into account. We consider each technology in the following subsections.

5.1.1.1 CHP (Reciprocating Engines and Micro-turbines) Technical Potential

CHP technologies can substitute 1:1 for grid power. The technical potential is therefore the amount of power being used by applicable customer classes. In the case of CHP, market studies and our own work has shown that smaller installations are uneconomic, so our technical potential focused on large

commercial users. We multiplied the total number of large commercial customers times the minimum peak summer loads. For example, in Utah, large commercial class customers (schedule 8 electricity rates) number 274, and the minimum peak load for these customers is 661 kW, yielding a technical potential of $274 \times 661 \text{ kW} = 181 \text{ MW}$. Customer information and building load data was provided by PacifiCorp for each state.

We then compared these technical potentials to a 2013 CHP national assessment, called “The Opportunity for CHP in the United States”⁴². This national assessment provides technical potential figures by state, so we multiplied their state estimates times PacifiCorp’s area coverage ratio to determine the studies assessment of CHP potential per this study.

Table 5-1. CHP Technical Potential

State	“The Opportunity for CHP in the United States”		PacifiCorp Data	
	2013 State Potential (MW) ⁴³	% PacifiCorp Coverage	PacifiCorp Potential	2013 Customer x Load Potential (MW)
CA	6456	7%	452	15
ID	211	11%	23	11
OR	657	22%	145	303
UT	418	72%	301	181
WA	1052	4%	42	67
WY	105	39%	41	135

In three states, WA, WY, and OR, the PacifiCorp data exceeded the figures from the national assessment. In these cases (shown in green) we reduced the technical potential to match the national study, which utilized more data regarding the availability of economic thermal loads; conversely, given the imprecision in the % coverage estimates, we conservatively used PacifiCorp’s data when it was lower than that assessed by the study (CA, ID, and UT). The difference in CA is especially stark, as PacifiCorp’s territory is mostly forested area with little large commercial activity. The bolded figures in Table 5-1 are the final technical potential used for each state.

We also examined current CHP installations < 2 MW from available databases, and found a very low number of installations. In Table 5-2, the 2nd column shows the total number of reciprocating engine CHP projects since 1980 installed, with the number following the slash showing what proportion of these are less than 2 MW in size.

⁴² ICF International, Hedman et al, May 2013, for the American Gas Association

⁴³ ibid, Table 7 (industrial 50-1000 kW + 1-5MW categories) + Table 8 Commercial (same categories), p32-33.

Table 5-2. CHP Install Base

Combined Heat and Power National Database ⁴⁴		
State	1980-2013 Reciprocating Engine Installations (Total / < 2 MW) [in MW]	1980-2013 Micro-turbine Installations [in MW]
CA	550 / 8.3	34
ID	19 / 3.7	0
OR	48 / 14	.5
UT	42 / 4.5	0
WA	21 / 7	.3
WY	.5 / .4	.08

Given this very small installation base since 1980 within PacifiCorp’s territory, and summarizing, we conservatively used the minimum CHP technical potential from two sources, PacifiCorp’s customer data, and an area-ratio estimate from a national CHP study.

5.1.1.2 Small Hydro Technical Potential

The detailed national small hydro studies conducted by the Department of Energy in 2004 to 2013, referenced in Section 2.1.5 formed the basis of our estimate of technical potential for small hydro. In the Pacific Northwest Basin, which covers WA, OR, ID, and WY, a very detailed stream by stream analysis was done in 2013, and DOE sent us this data directly. For these states we had detailed GIS PacifiCorp service territory data combined with detailed GIS data on each stream / water source. For each state, we subtracted out the streams that were not in PacifiCorp’s service territory, and summed the technical potentials.

For the other two states, Utah and California, we relied on an older 2006 national analysis, and multiplied the given state figures time the area coverage for PacifiCorp within that state that are shown on Table 5-1 above.

⁴⁴ <http://www.eea-inc.com/chpdata>. This ICF database is supported by the US Department of Energy and Oak Ridge National Laboratory. It was accessed 6/1/2014.

Table 5-3. Small Hydro Technical Potential Results

State	2012 Small Hydro Potential (MW) ⁴⁵
CA	32
ID	99
OR	161
UT	62
WA	156
WY	28

5.1.1.3 Photovoltaic Technical Potential

For photovoltaics, a similar approach was taken as the CHP technologies above. We assessed peak load from customer data records provided by PacifiCorp and multiplied by summer peak loads to determine technical potential for each customer class (i.e. rate schedule)⁴⁶. Rate schedules and customer classes analyzed were chosen according to the following criteria:

1. Rate classes must represent significant revenue
2. Single customer contracts are excluded to preserve confidentiality
3. Partial requirements customers are generally large, over 1 MW, and are qualifying facilities under PURPA and therefore not net-metered customers. They have been excluded.
4. Transmission voltage customers were excluded, as PV projects at these voltage levels are likely to be large-scale PV fields, and exceed the 2 MW net metering limit

We then compared this to the estimated maximum PV array available on the rooftop for an average member of this customer class; the available rooftop area in some cases limited technical potential (for large power users, sometimes sharply). Our assumption is that ground mount system sizes will be larger than the 2 MW net metering limit, and are therefore accounted for elsewhere in the IRP.

To estimate maximum available PV array size, we multiplied a number of factors:

- **Average rooftop size**, derived from PacifiCorp surveys on establishment square feet, divided by an average of two stories
- **Assumed PV access factor**. Residential tilted rooftops have a 1 in 4 chance of facing south; commercial rooftop access factor is higher as rooftops are flat, but some shading occurs
- **Average PV Module Power density (W/Sq Ft)**. Derived from typical packing factor of 80% (accounting for maintenance footpaths, tilted racking, etc.) and 2013 manufacturer module power specification sheets

⁴⁵ Note, average hydro technical potential is not likely to change annually

⁴⁶ Note customer classes were chosen

An example of this system size calculation is shown for Utah in Table 5-4. Columns 2 through 4 were multiplied together to obtain column 5, and the minimum of the 2013 system size and the summer peak load is the output in the rightmost column.

Table 5-4. PV System Size per Customer Class Example (Utah)

2103 Utah Customer Class (Rate Schedule)	Maximum Available PV Array Size				Peak Load	Which One Chosen
	Average floor size	PV Access Factor	2013 average PV Power density	2013 system size	2013 Summer Peak Load	Class System Size
	sf	%	W/sf	kW	kW	kW
Large Commercial (8)	17600	65%	12	137	1112.7	137
Irrigation (10)	17600	65%	12	137	33.9	33.9
Residential (1)	1258	25%	15	4.7	2.8	2.8
Small Commercial (23)	9600	65%	12	75	3.4	3.4
Small Industrial (6)	11464	65%	12	89.4	89.6	89.4

This output column of class system size was then multiplied by the number of customers to obtain technical potential per class. The commercial classes were then summed to show final residential and commercial technical potential for the state of Utah, as shown in Table 5-5.

Table 5-5. Utah PV Technical Potential

2103 Utah Customer Class (Rate Schedule)	Class System Size	Number of Customers	Technical Potential per Class	Commercial / Residential Technical Potential
	kW		(MW)	Total (MW)
Large Commercial (8)	137	274	38	1580
Irrigation (10)	33.9	2784	94	
Small Commercial (23)	3.4	82668	282	
Small Industrial (6)	89.4	13072	1169	
Residential (1)	2.8	740189	2096	2100

5.1.1.4 Small Wind

For small wind, NREL publishes wind data in GIS format⁴⁷. An example wind resource map is shown in Figure 5-1. Using PacifiCorp GIS service territory data, we excluded areas in each state outside of its service territory, and then proportionally determined the area within the territory that was Class 4 and above (i.e. the non-green area Figure 5-1 divided by total service area).

Figure 5-1. US Wind Resource Map

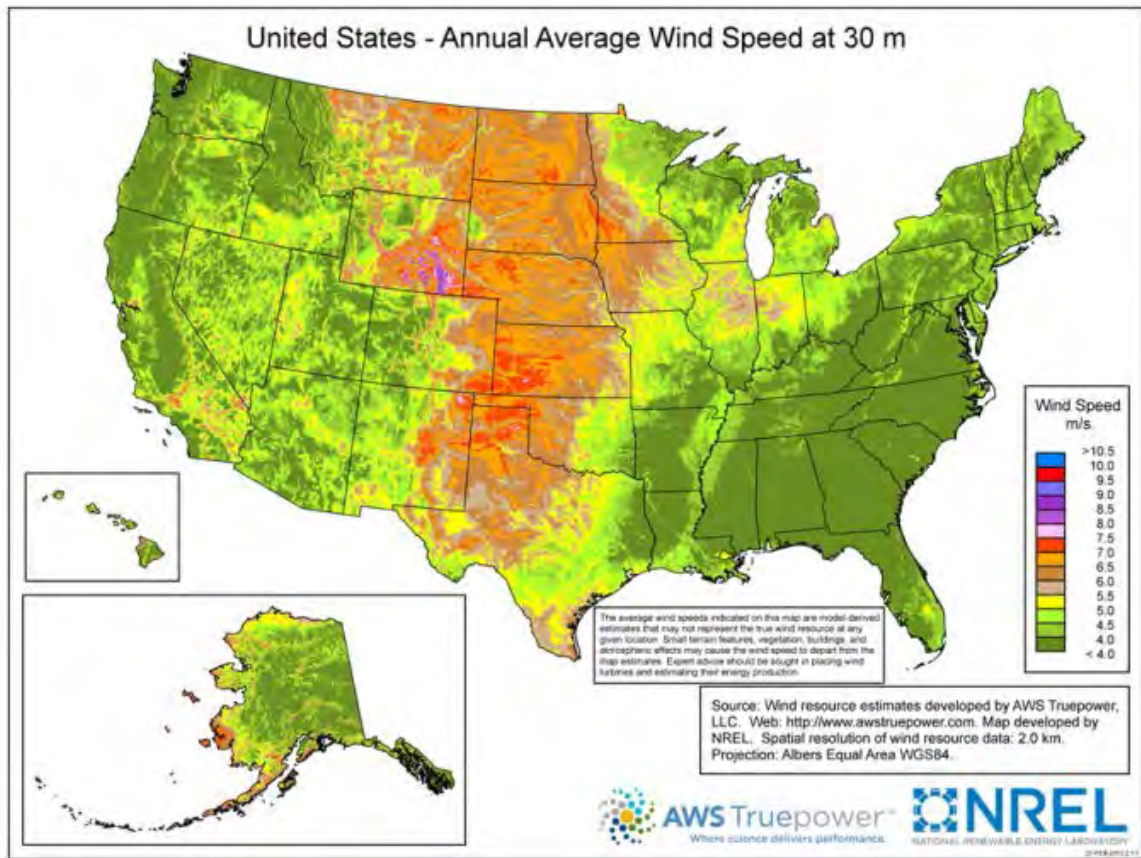

These proportions were multiplied by (the customer peak load) times (number of customers) to determine the technical potential for small wind within PacifiCorp’s service territory. A summary of the results is shown in Table 5-6.

⁴⁷ http://www.nrel.gov/gis/data_wind.html

Table 5-6. Small Wind Technical Potential Results

State	% Class 4+ in service territory	Small Wind Technical Potential (MW) ⁴⁸	
		Residential	Commercial
CA	5%	.8	3.9
ID	5.4%	10	6
OR	8.4%	19	62
UT	16%	48	116
WA	8.4%	5	15
WY	50.7%	62	139

Wyoming has the highest technical potential due to its very high wind; Utah is next because a large number of customers within Utah are PacifiCorp customers and it has relatively higher wind resources.

5.1.1.5 Technical Potential Over Time

The previous subsections show how Navigant calculated technical potential in 2013. To project how technical potential will change over time (because of either more customers or larger loads per customer), Navigant escalated technical potentials at the same rate PacifiCorp projects its load will change over time. PacifiCorp provided Navigant with its load forecast through 2034.

5.1.2 Simple Payback

For each customer class (rate schedule), technology, and state, Navigant calculates simple payback period using the following formula:

Simple Payback Period = $(\text{Net Initial Costs}) / (\text{Net Annual Savings})$

Net Initial Costs = Installed Cost – Federal Incentives – Capacity Based Incentives*(1 – Tax Rate)

Net Annual Savings = Annual Energy Bills Savings + (Performance Based Incentives – O&M Costs – Fuel Costs)*(1 – Tax Rate)

- Federal tax credits can be taken against a system’s full value if other (i.e. utility or state supplied) capacity based or performance based incentives are considered taxable.
- Navigant’s Market Penetration model calculates first year simple payback assuming new installations for each year of analysis.
- For electric bills savings, Navigant conducted an 8760 hourly analysis to take into account actual rate schedules, actual output profiles, and demand charges. CHP performance and hydro performance assumptions are listed in the relevant performance / cost assumptions in section 3. PV performance and wind performance profiles were calculated for representative locations

⁴⁸ The wind data this table is based on was last updated June 2012

within each state based on the solar advisory model (which now also models wind). Building load profiles were provided by PacifiCorp, and were scaled to match the average electricity usage for each class based on billing data.

- For thermal savings (if a CHP technology is chosen), the model examines at annual space heating loads and assume most of that is offset by CHP.

Tax rates used are listed in Table 5-7. We used a tax calculator to estimate federal tax rates for median household incomes, and added this to state sales taxes and state income taxes to estimate a residential household tax rate for each state.

Table 5-7. Residential Tax Rates

	Median Household Income (\$\$) ⁴⁹	Federal Income Tax Rate as % of Income ⁵⁰	2013 State Sales Tax ⁵¹	State Income Tax ⁵²	2013 Residential Tax Rate
CA	\$58,328	8%	8%	7%	22.9%
ID	\$45,489	6%	6%	5%	17.3%
OR	\$49,161	7%	0%	8%	14.7%
UT	\$57,049	8%	5%	5%	17.8%
WA	\$57,573	8%	7%	0%	14.6%
WY	\$54,901	8%	4%	0%	11.8%

To estimate commercial taxes, we added federal corporate taxes of 35% to state sales taxes, as shown in Table 5-8.

Table 5-8. Commercial Tax Rate

	2013 State Sales Tax	Federal Corporate Tax	2013 Commercial Tax Rate
CA	8%	35%	43%
ID	6%		41%
OR	0%		35%
UT	5%		40%
WA	7%		42%
WY	4%		39%

⁴⁹ <http://www.deptofnumbers.com/income/>. Latest available data is for 2012

⁵⁰ www.calcxml.com

⁵¹ <http://www.taxrates.com/state-rates>

⁵² <http://www.tax-rates.org/taxtables/income-tax-by-state>

5.1.3 Payback Acceptance Curves

For distributed resources, Navigant used the following payback acceptance curves to model market penetration of DG sources from the retail customer perspective:

Figure 5-2. Payback Acceptance Curves

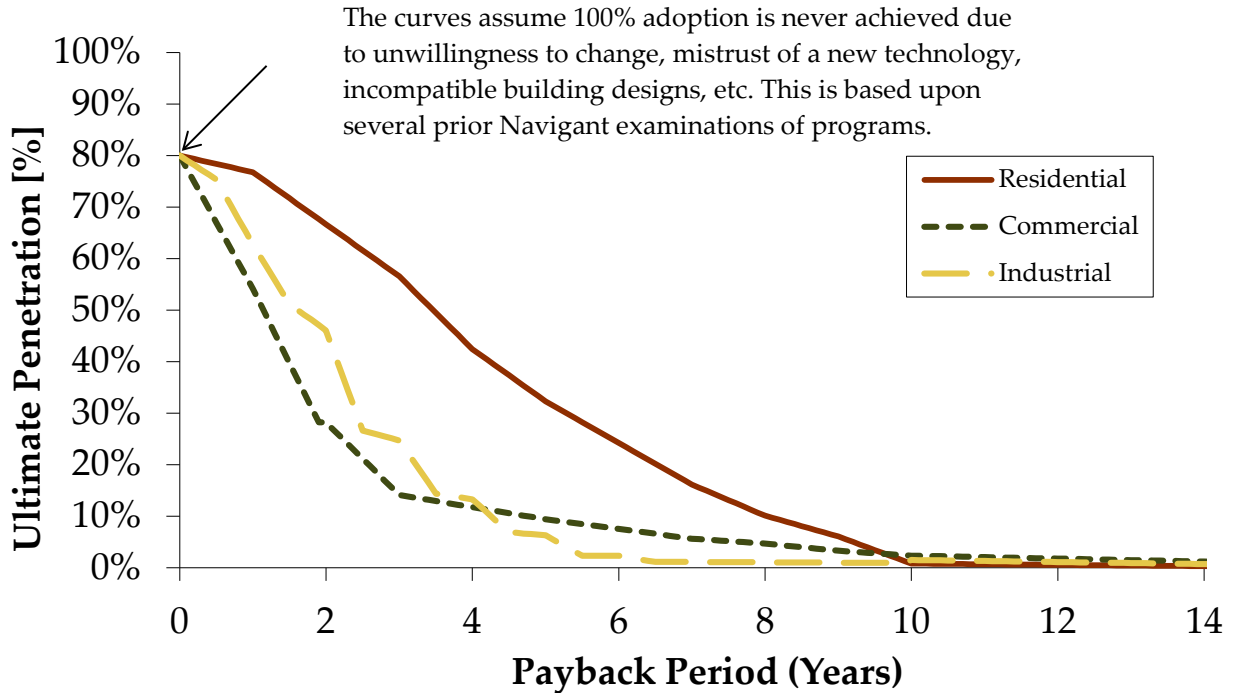

These payback curves are based upon work for various utilities, federal government organizations, and state local organizations. They were developed from customer surveys, mining of historical program data, and industry interviews. Given a calculated payback, the curve predicts what ultimate level of market penetration of the technical potential is likely. For example, if the technical potential is 100MW, a 3 year commercial payback predicts that 15% of this, or 15MW, will be ultimately achieved over the long term.

5.1.4 Market Penetration Curves

To determine the future DG market penetration within PacifiCorp’s territory, the team modeled the growth of DG technologies between now and 2034 for the IRP. The model is a Fisher-Pry-based technology adoption model that calculates the market growth of DG technologies. It uses a lowest-cost approach (to consumers) to develop expected market growth curves based on maximum achievable market penetration and market saturation time, as defined below.⁵³

⁵³ Michelfelder and Morrin, “Overview of New Product Diffusion Sales Forecasting Models” provides a summary of product diffusion models, including Fisher-Pry. Available: law.unh.edu/assets/images/uploads/pages/ipmanagement-new-product-diffusion-sales-forecasting-models.pdf

- **Market Penetration** – The percentage of a market that purchases or adopts a specific product or technology. The Fisher-Pry model estimates the achievable market penetration based on the simple payback period of the technology (per the curve show in Figure 5-2)
- **Market Saturation Time** – The duration (in years) for a technology to increase market penetration from 10% to 90%.

The Fisher-Pry model estimates market saturation time based on 12 different market input factors; those with the most substantial impact include:

- **Payback Period** – Years required for the cumulative cost savings to equal or surpass the incremental first cost of equipment.
- **Market Risk** – Risk associated with uncertainty and instability in the marketplace, which can be due to uncertainty over costs, industry viability, or even customer awareness, confidence, or brand reputation. An example of a high market risk environment is a jurisdiction lacking long-term, stable guarantees for incentives.
- **Technology Risk** – Measures how well-proven and readily available the technology is. For example, technologies that are completely new to the industry are higher risk, whereas technologies that are only new to a specific market (or application) and have been proven elsewhere would be lower risk.
- **Government Regulation** – Measure of government involvement in the market. A government stated goal is an example of low government involvement, whereas a government mandated minimum efficiency requirement is an example of high involvement, having a significant impact on the market.

The model uses these factors to determine market growth instead of relying on individual assumptions about annual market growth for each technology or various supply and/or demand curves that may sometimes be used in market penetration modeling. With this approach, the model does not account for other more qualitative limiting market factors, such as the ability to train quality installers or manufacture equipment at a sufficient rate to meet the growth rates. Corporate sustainability, and other non-economic growth factors, are also not modeled.

The model is an imitative model that uses equations developed from historical penetration rates of real products for over two decades. It has been validated in this industry via comparison to historical data for solar photovoltaics, a key focus of the study. The Fisher-Pry market growth curves have been developed and refined over time based on empirical adoption data for a wide range of technologies. Some of the original technologies used to develop the Fisher-Pry model include: water-based versus oil-based paints, plastic versus metal in cars, synthetic rubber for natural rubber, organic versus inorganic insecticides, and jet-engine aircraft for piston-engine aircraft.⁵⁴ Figure 5-3 shows four example market growth curves from the model, each with different market saturation times (5, 10, 15, & 20 years) and increasing achievable market penetration. Although increased market penetration (reduced payback period) can go hand-in-hand with reduced saturation time, these plots are intended to illustrate that to reach near-term

⁵⁴ Fisher, J. C. and R. H. Pry, "A Simple Substitution Model of Technological Change", *Technological Forecasting and Social Change*, 3 (March 1971), 75-88.

goals, reducing market saturation time is more important than maximizing the long-term achievable market penetration. However, with increased long-term maximum achievable penetration, it may be possible to achieve the same near-term market growth goals with a longer (and less burdensome) market saturation time.

Figure 5-3. Fisher-Pry Market Penetration Dynamics

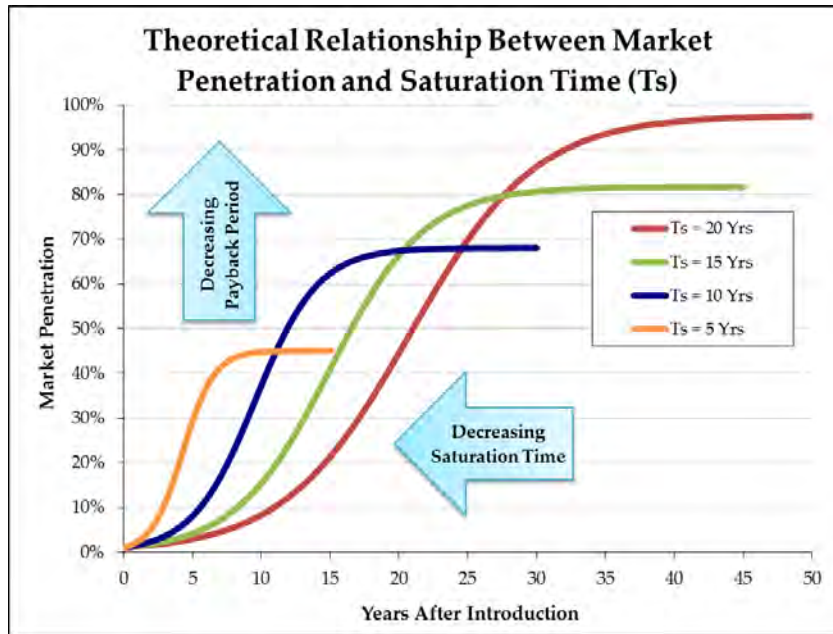

The market penetration curves used in this study, Navigant assumed that the first year introduction occurred when the simple payback period was less than 25 years (per the payback acceptance curves used, this is the highest payback period that has any adoption. When the above payback period, market risk, technology risk, and government regulation factors above are analyzed, our general Fisher-Pry based method gives rise to the following market penetration curves used in this study:

Figure 5-4. DG Market Penetration Curves Used

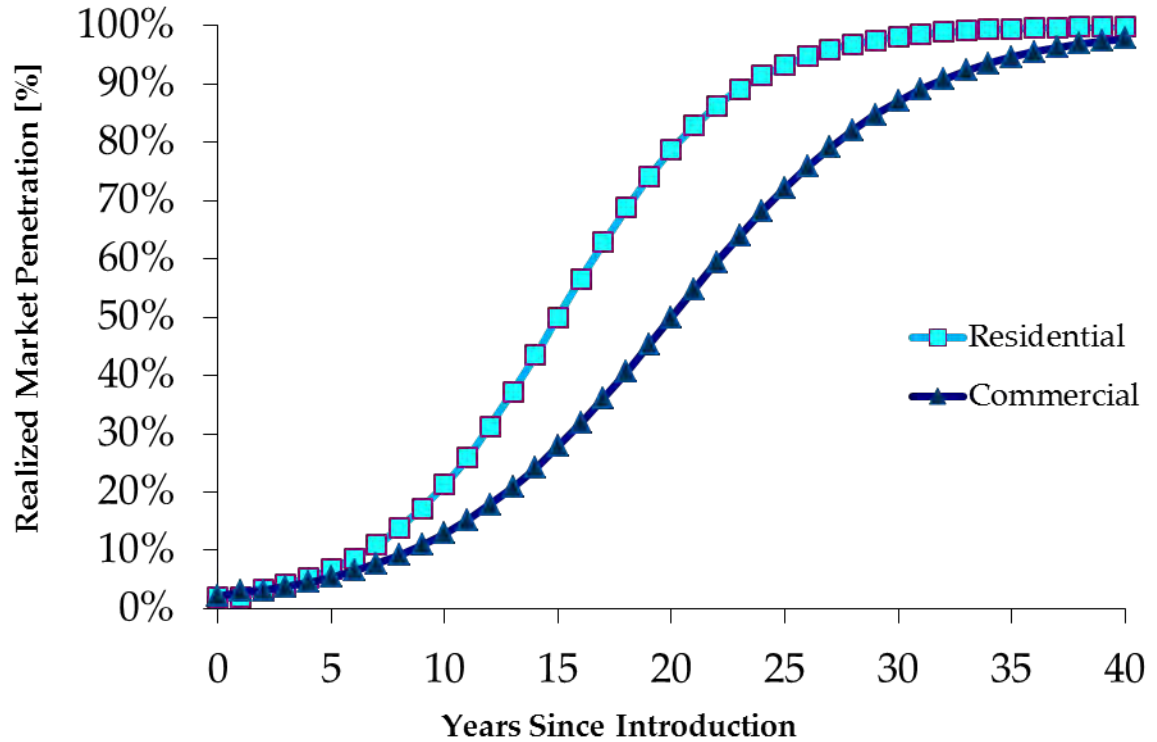

The model is designed to analyze the adoption of a single technology entering a market, and we assume that the DG market penetration analyzed for each technology is additive because the underlying resources limiting installations (sun, wind, hydro, high thermal loads) are generally mutually exclusive (wind tends to blow harder at night when the sun is not available, etc.), and because current levels of market penetration are relatively low—there are plenty of customers available for each technology. For future IRP efforts when market penetrations are higher, we recommend increasing accuracy by ratio-ing competing technologies by payback period to ensure no double-counting.

5.1.5 Scenarios

Navigant analyzed three DG scenarios with its market penetration model, to capture the impact of major changes that could affect market penetration. For the low and high penetration cases, we varied technology costs, performance, and electricity rate assumptions per Table 5-9:

Table 5-9. Scenario Variable Modifications

Scenarios			
	Technology Costs	Performance	Electricity Rates
Base Case	<ul style="list-style-type: none"> • See section 3. 	<ul style="list-style-type: none"> • As modeled 	<ul style="list-style-type: none"> • Inflation rate per IRP
Low DG Penetration	<ul style="list-style-type: none"> • Hydro (mature): 0% • PV: 10% lower cost reduction/year • Other: 5% lower cost reduction/year 	<ul style="list-style-type: none"> • 5% worse 	<ul style="list-style-type: none"> • -.5%/year, relative to the base case
High DG Penetration	<ul style="list-style-type: none"> • Hydro (mature): 2% cost reduction/year • PV: 10% steeper cost reduction/year • Other: 5% steeper cost reduction/year 	<ul style="list-style-type: none"> • Reciprocating Engines: 0% better (mature) • Micro-turbines: 2% better • Hydro: 5% better (reflecting wide performance distribution uncertainty) • PV/Wind: 1% better (relatively mature) 	<ul style="list-style-type: none"> • +.5%/year, relative to the base case

The primary driving variable is the amount of cost reduction expected over the next 20 years. Average technology performance assumptions are relatively constant, with a higher variability for hydro as project output is more variable and site specific. Finally, electricity rate changes are modeled in a relatively conservative band, reflecting the long-term stability of electricity rates in the United States. Note that these are all changes to the averages over 20 years, and we expect higher one- year or short term volatility on all of these variables, both up and down. However, when averaged over a long period of time for the 20-year IRP period, long-term trends show this level of variation.

6. Results

6.1 Technical Potential

While technical potential results have been shared for most technologies in the last section, these are summarized by the following graph:

Figure 6-1. Technical Potential Results

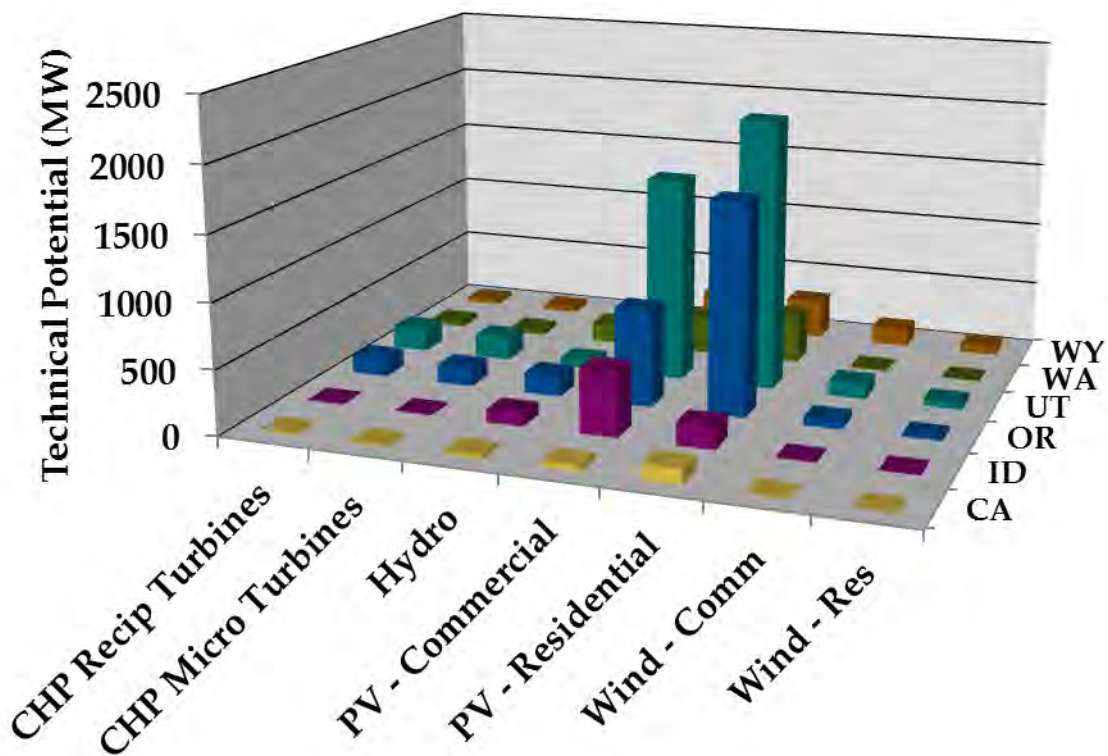

As can be seen, the PV (both commercial and residential) technical potential is the highest of all the DG technologies evaluated. Total technical potential is ~10 GW, roughly equivalent to PacifiCorp's peak summer loads. As indicated in the technical barriers section, it may be difficult for PacifiCorp to incorporate total levels of PV (both DG and large-scale fields) beyond 20-33% without economical energy storage.

6.2 Overall Scenario Results

As shown in Figure 6-2, the near-term ten-year outlook is ~50 MW until 2021, when cost reduction and continued UT/OR incentives significantly improves payback and PV uptake increases dramatically, reaching 900 MW by 2034, the end of the IRP period.

Figure 6-2. Base Case Results

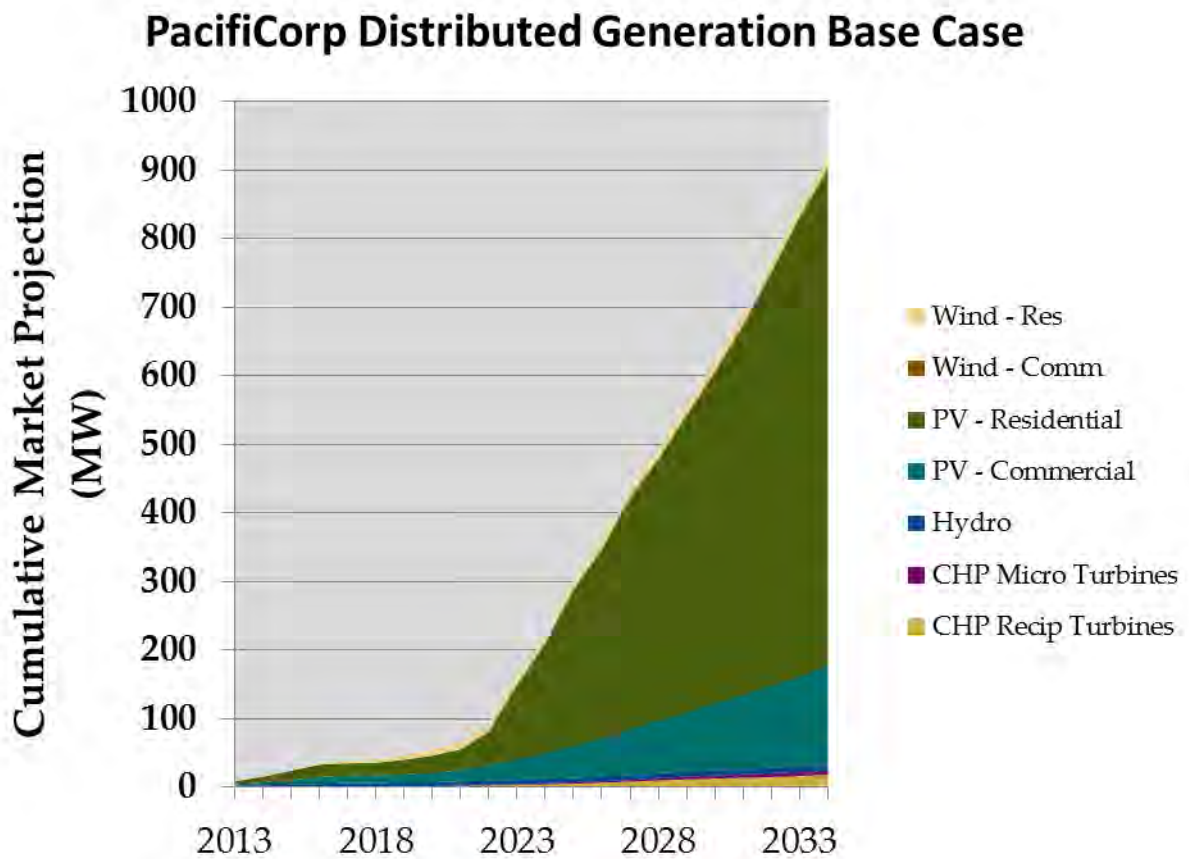

In the low penetration scenario, lower cost reduction than expected results in less short term market penetration, ~ 30 MW; the knee of the higher uptake curve is delayed until 2029 relative to the base case. Over the entire period, penetration is 275 MW by 2034, 60% lower than the base case.

Figure 6-3. Low Penetration Scenario Results

PacifiCorp Distributed Generation Low Penetration Case

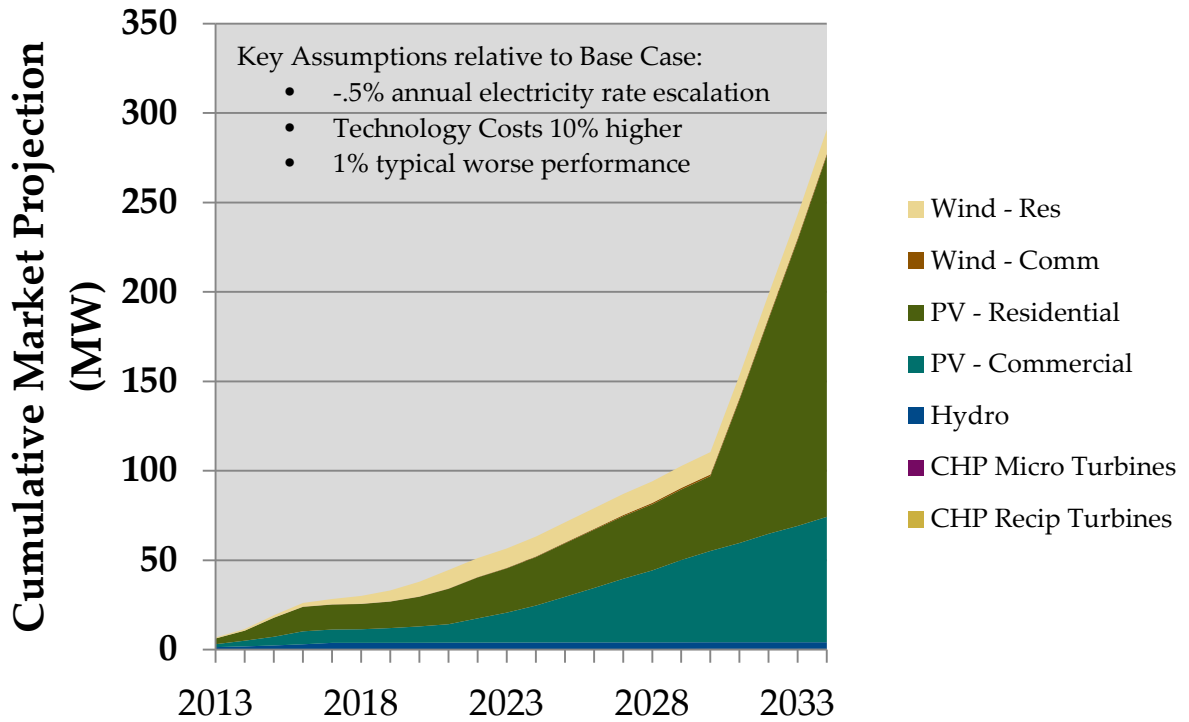

Conversely, in the high penetration scenario, lower costs than expected over the long-term combined with continued UT incentives have the potential to increase DG penetration by 2034 to 2.6 GW from a customer economics perspective.

Figure 6-4. High Penetration Scenario Results

PacifiCorp Distributed Generation High Penetration Case

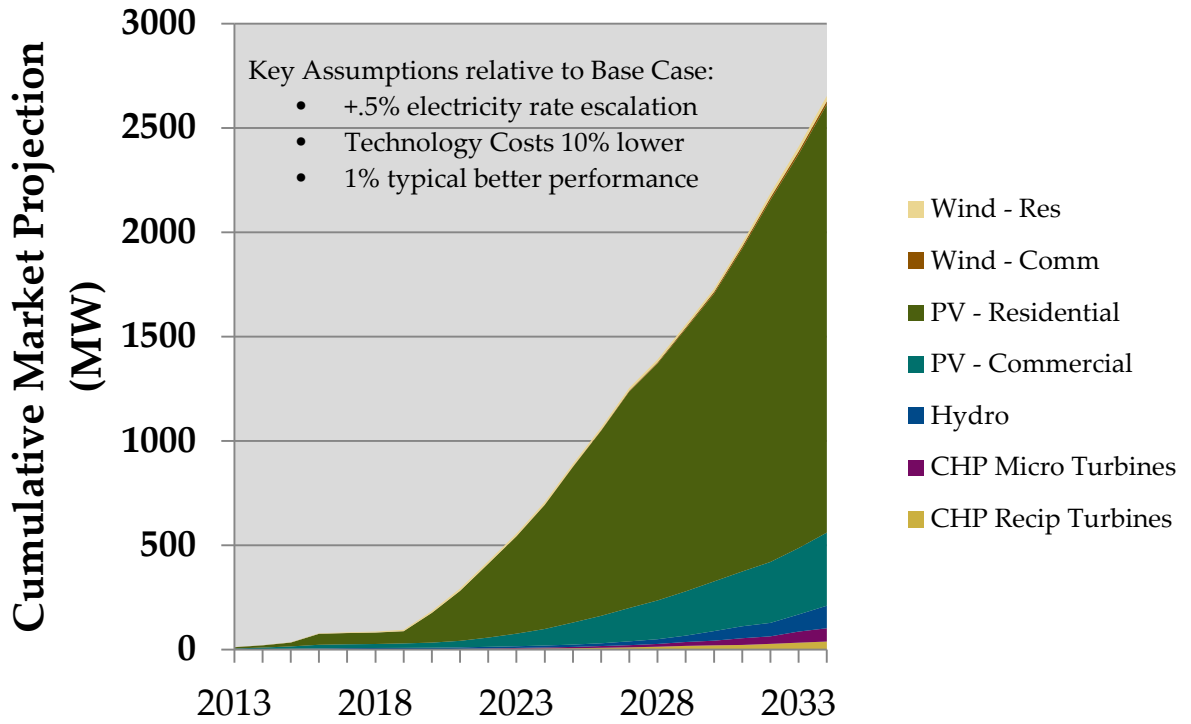

6.3 Results by State

In this section, we present the results of the base case state by state:

In Utah, assumed continued PV state incentives and continuing cost reductions spur the PV market, especially after medium term year 2021, and penetration is projected to increase to ~750 MW in the base case by 2034.

Figure 6-5. Utah Base Case Results

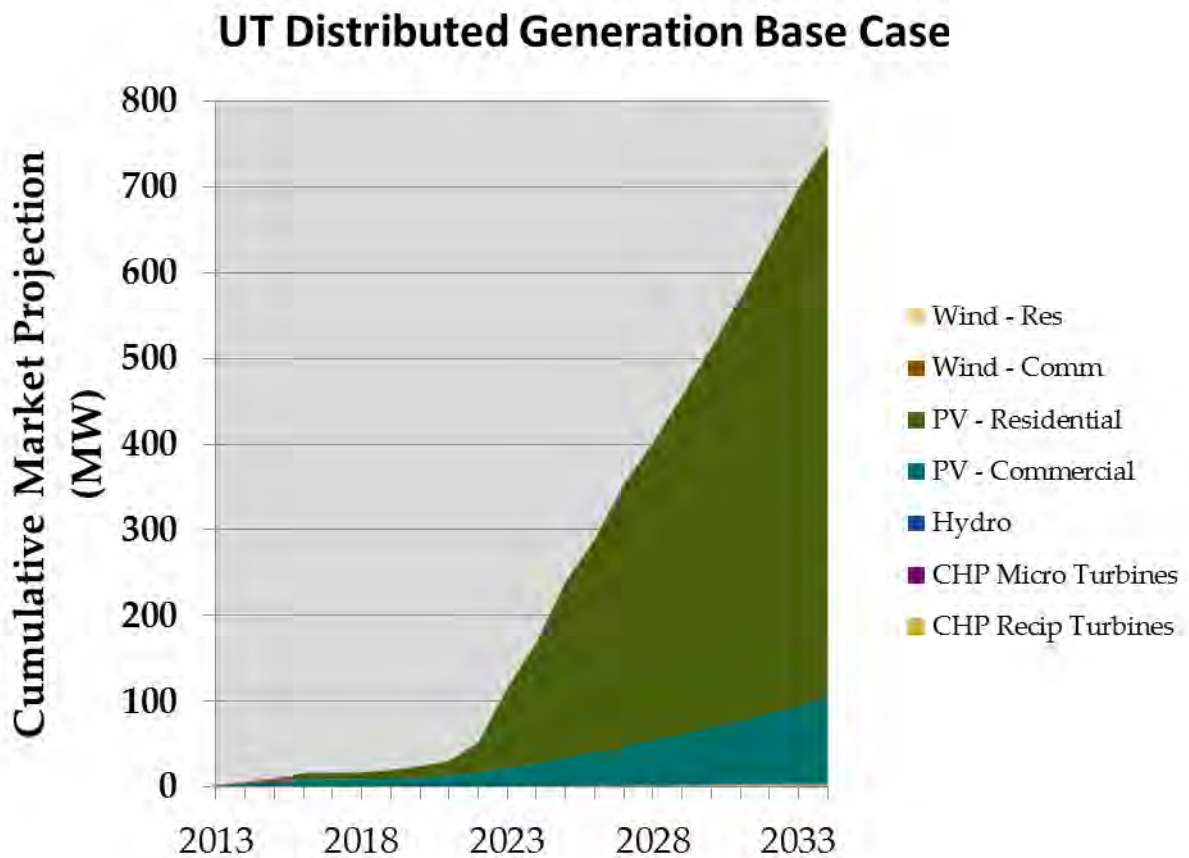

To illustrate the underlying drivers for this Utah result, which is large proportion of DG penetration for PacifiCorp overall, let us examine a bit more closely the cases of Residential PV and small commercial PV customers in Utah.

Plotted in the figure below are the residential installation costs minus incentives – the out of pocket installation cost -- against the annual electric energy savings for Utah residential PV customers. On a secondary axis to the right, the payback period is also shown. The out of pocket installation costs drop in the next few years due to cost reduction, shoot back up in 2017 with the expiration of federal incentives, and continue coming down due to assumed cost reductions over time. The annual electric

savings increase gently due to modest performance improvements and load growth⁵⁵. The payback period starts at 14 years in 2013, drops to 11 years by 2016, shoots back up to 14 years in 2017, and then, in year 2021, crosses the 10-year mark. At this point, penetration starts to increase (see lower graph). Even though the absolute levels of penetration are low (see Figure 5-2 for the payback curve), sizable market penetration in MW occurs because the residential market in Utah is relatively large.

The small commercial PV market in Utah is similar, except that significant periods of <10 year paybacks occur much later (a blip in 2016, and then 2028+), and the overall market potential is much smaller.

⁵⁵ Note, the calculations are assumed future average retail electricity rates, not variable costs which a customer can avoid.

Figure 6-6. Utah Residential PV Market Drivers

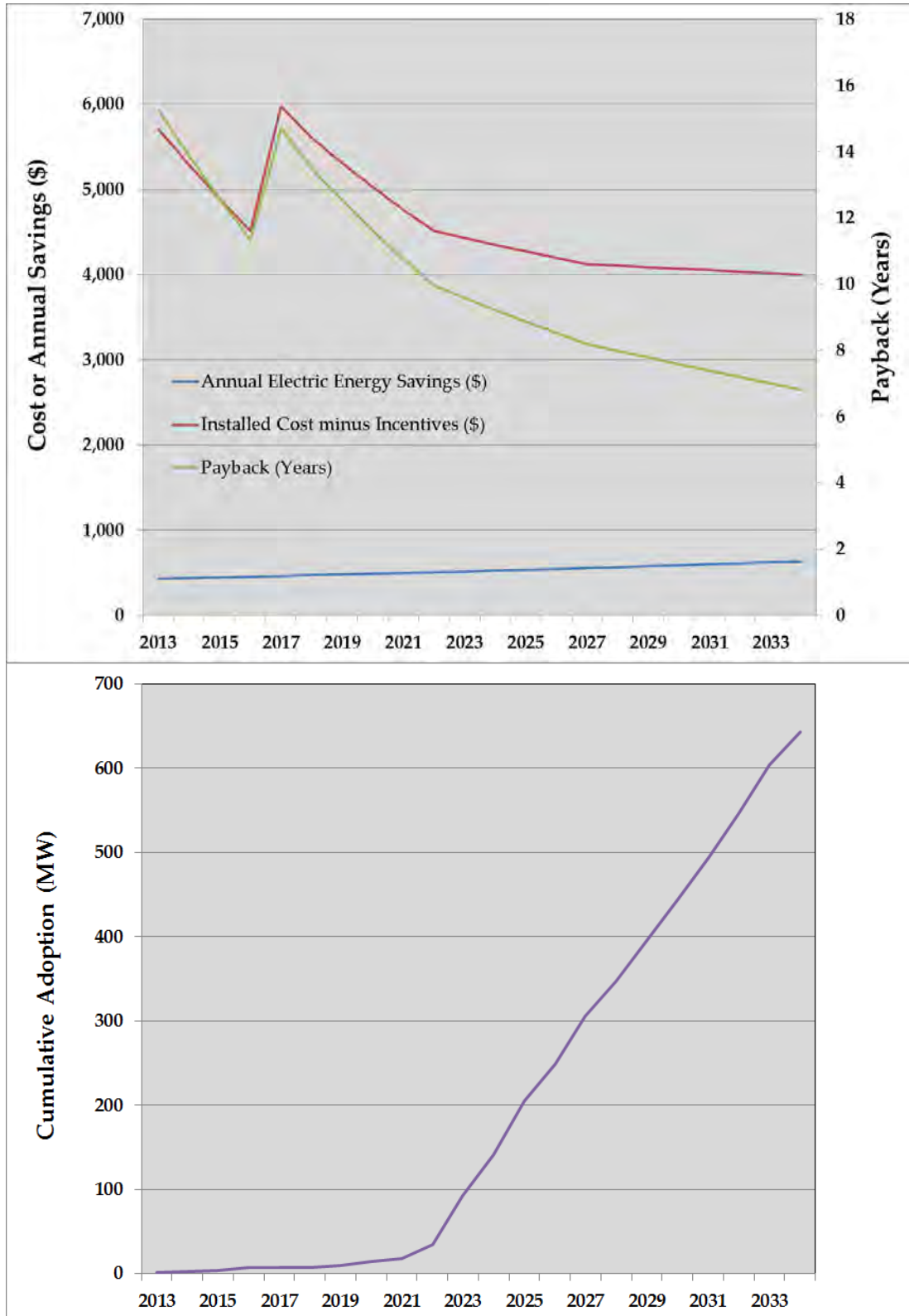

Figure 6-7. Utah Small Commercial PV Market Drivers

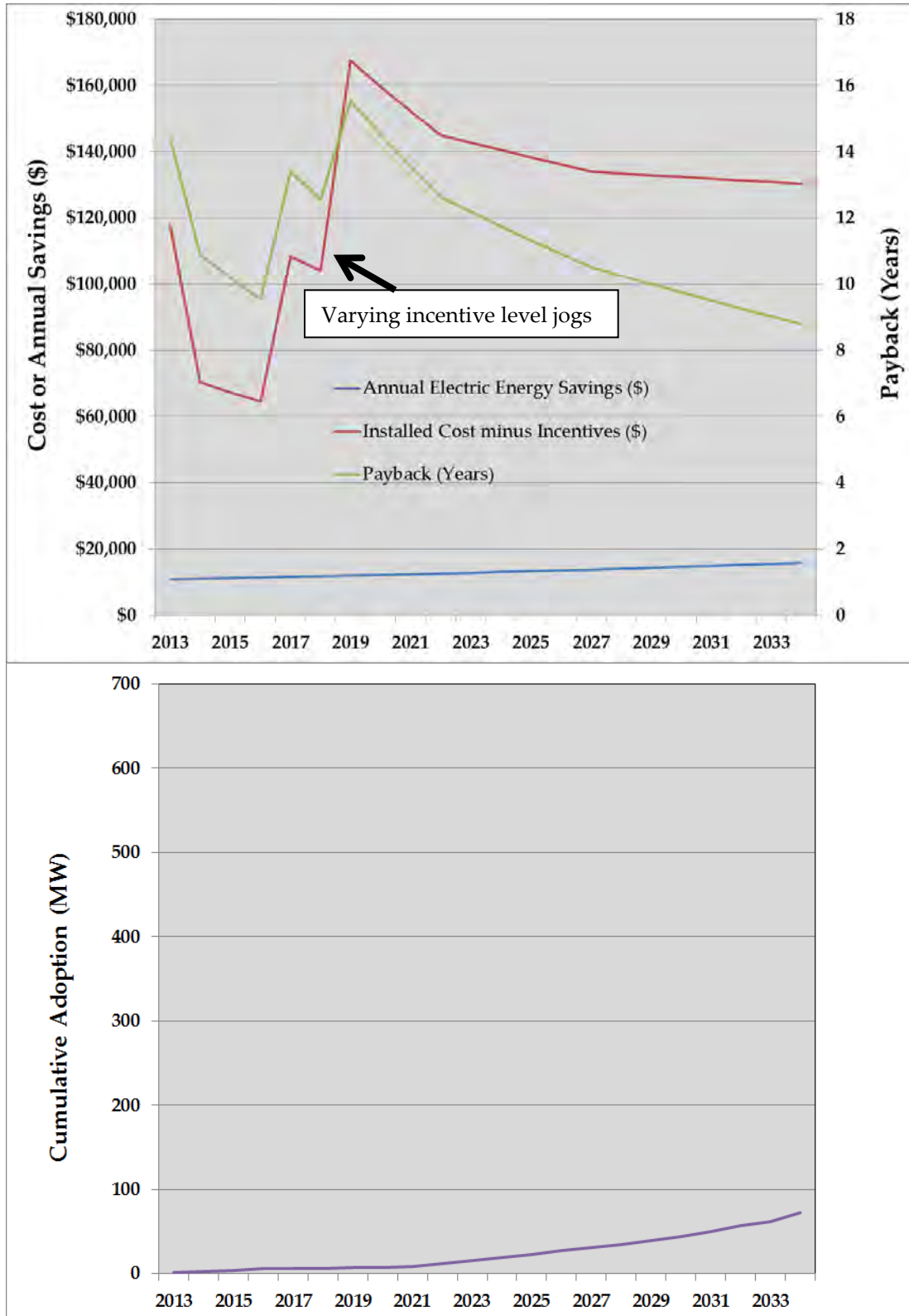
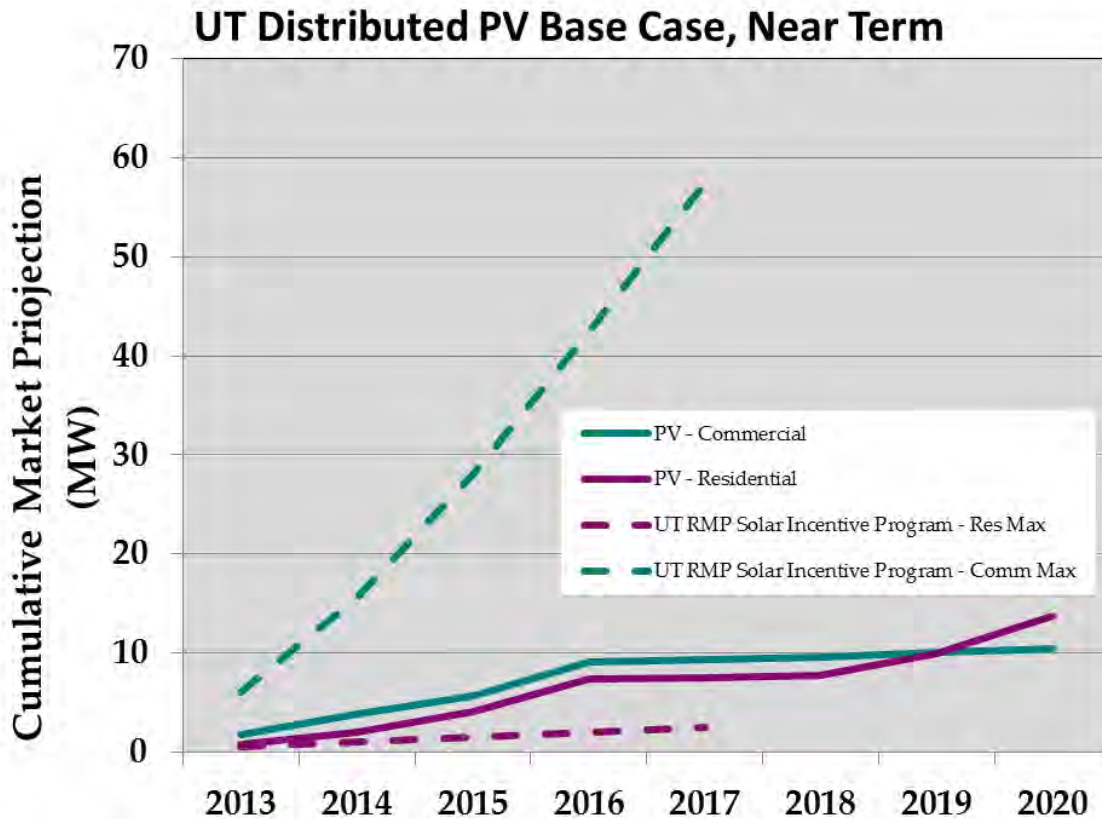

Figure 6-8. Utah Near-Term PV Projections



If we zoom in a little and examine only the near-term and PV-only in Utah, as shown in Figure 6-8, the consumer economic model is projecting that the commercial portion of PacifiCorp’s PV Incentive program may not have a high enough incentive level to achieve 60 MW of PV penetration by 2017, but that residential installations, while capped at .5 MW annually in the incentive program, will partially compensate⁵⁶. Note, as well, that commercial installations can be higher than projected due to corporate sustainability initiatives that are not captured in our economic model. For example, a single IKEA project last year in Utah of 1.5 MW quadrupled the total amount of commercial PV installations in Utah. Also, in 2016, we assume that the 30% federal Investment Tax Incentive will expire to 10%, leading to relatively flat installations for a few years until further cost reduction can compensate. The current program, as structured, does not compensate for this 20% projected increase in costs.

⁵⁶ Note, there is a 12-18 month delay between program permit acceptance and actual installation that was factored in to our calculations of this incentive

In California, with much higher electricity rates and a small PacifiCorp rebate program, grid parity is closer than in other PacifiCorp states and payback periods are lower. However, overall penetration is limited because CA is a very low (>5%) proportion of PacifiCorp revenue. Residential penetration dominates, but at an overall lower level than in Utah.

Figure 6-9. California Base Case Results

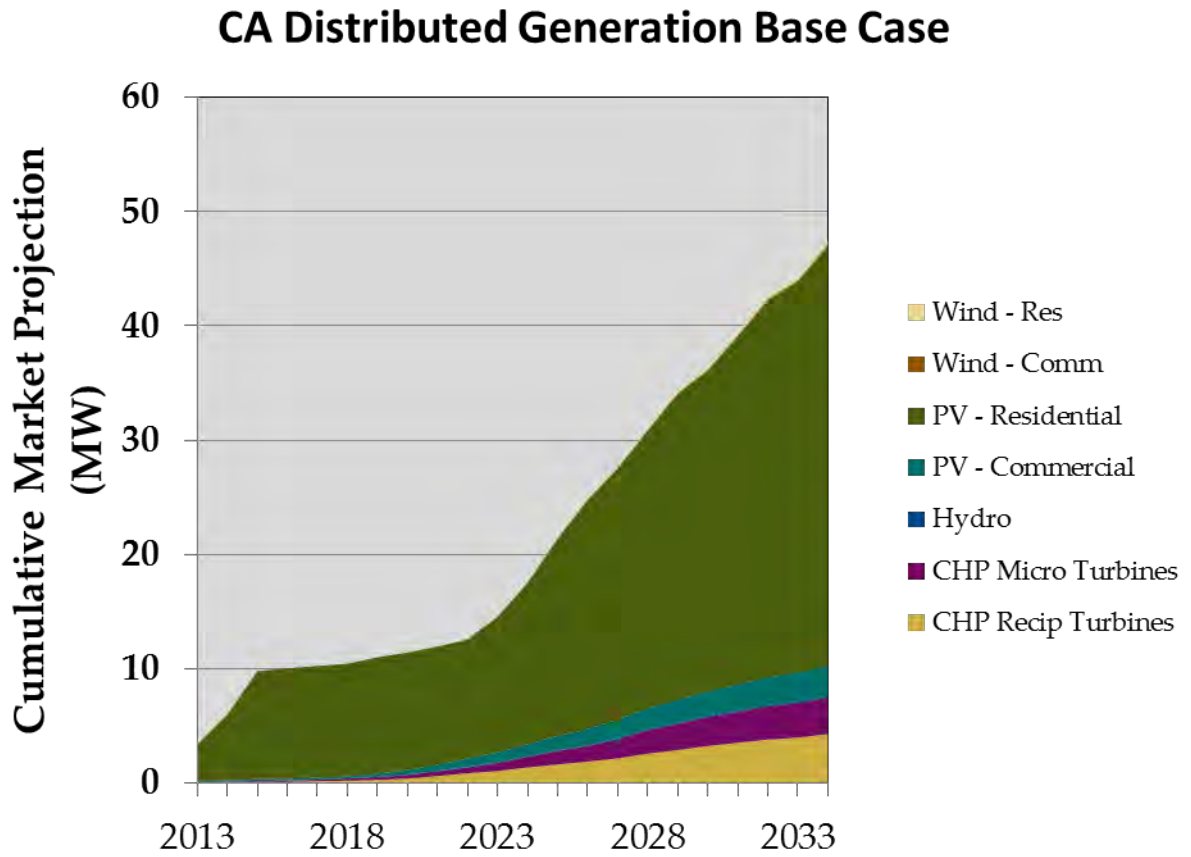

In Idaho, there is much larger commercial electricity use in PacifiCorp’s territory than residential. Accordingly, commercial PV is dominant, once PV prices reduce enough to achieve significant market penetration. Incentives are lower, so this transition occurs somewhat later than in other states, around 2023.

Figure 6-10. Idaho Base Case Results

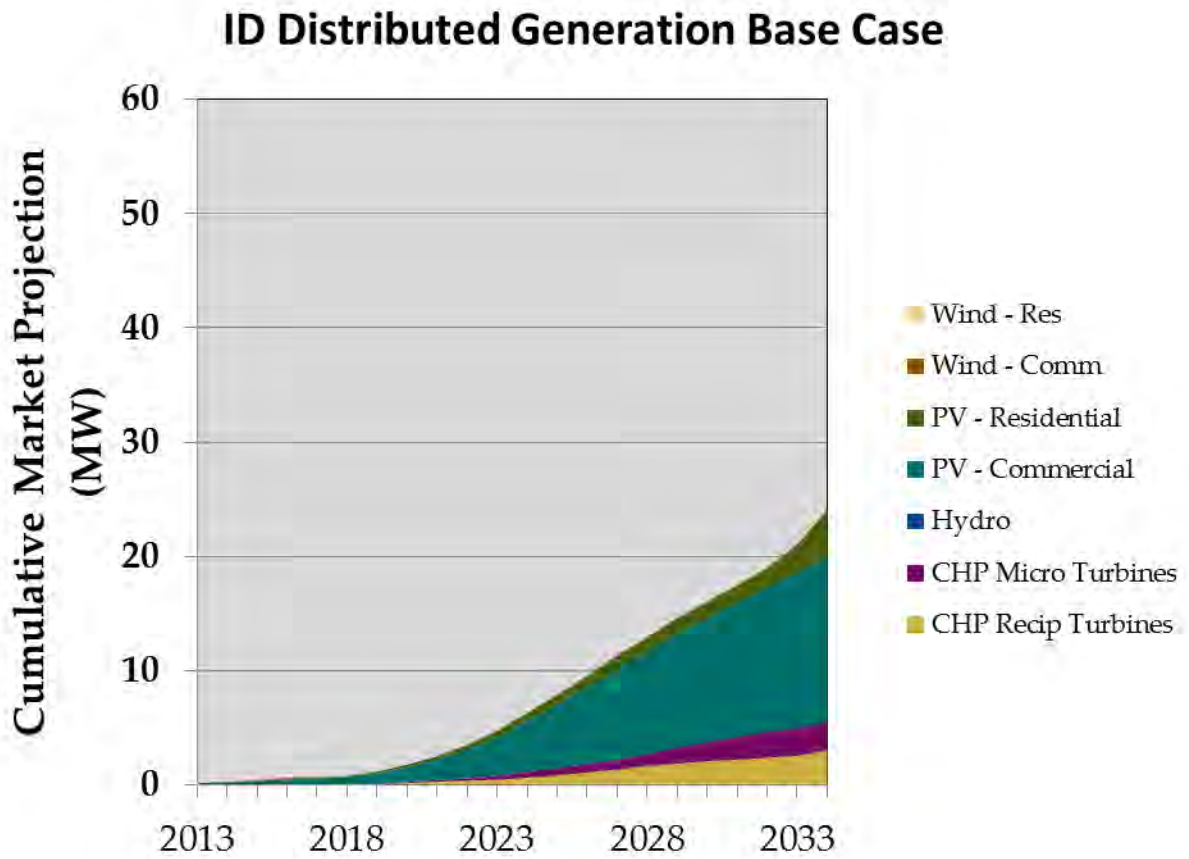

Oregon has a much larger small hydro technical potential than other states, and achieves some hydro penetration. Wind and PV incentives, and good wind availability, spur penetration of these sources. Overall, penetration is lower than in Utah due to longer payback periods.

Figure 6-11. Oregon Base Case Results

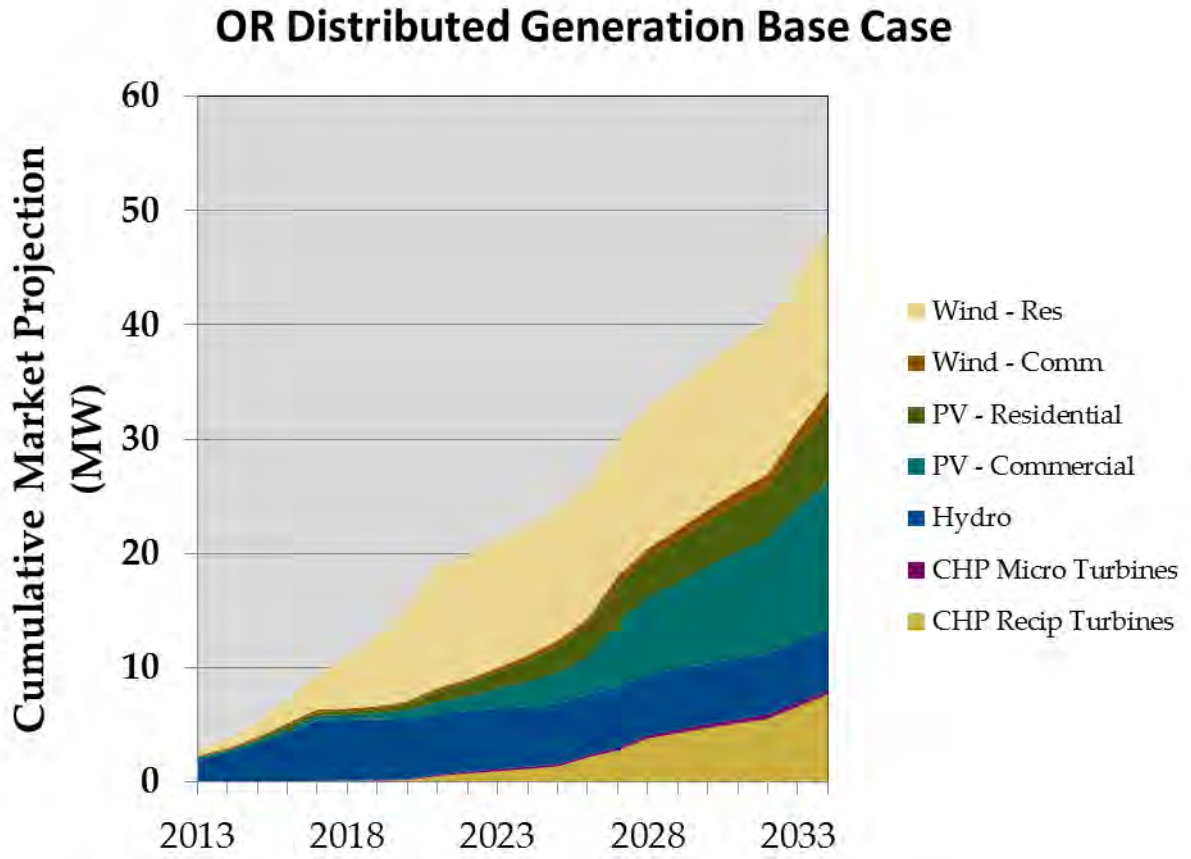

Washington, with a relatively small PacifiCorp area, and rates that are somewhat lower, is projected to achieve up to 10 MW by 2034 in the base case.

Figure 6-12. Washington Base Case Results

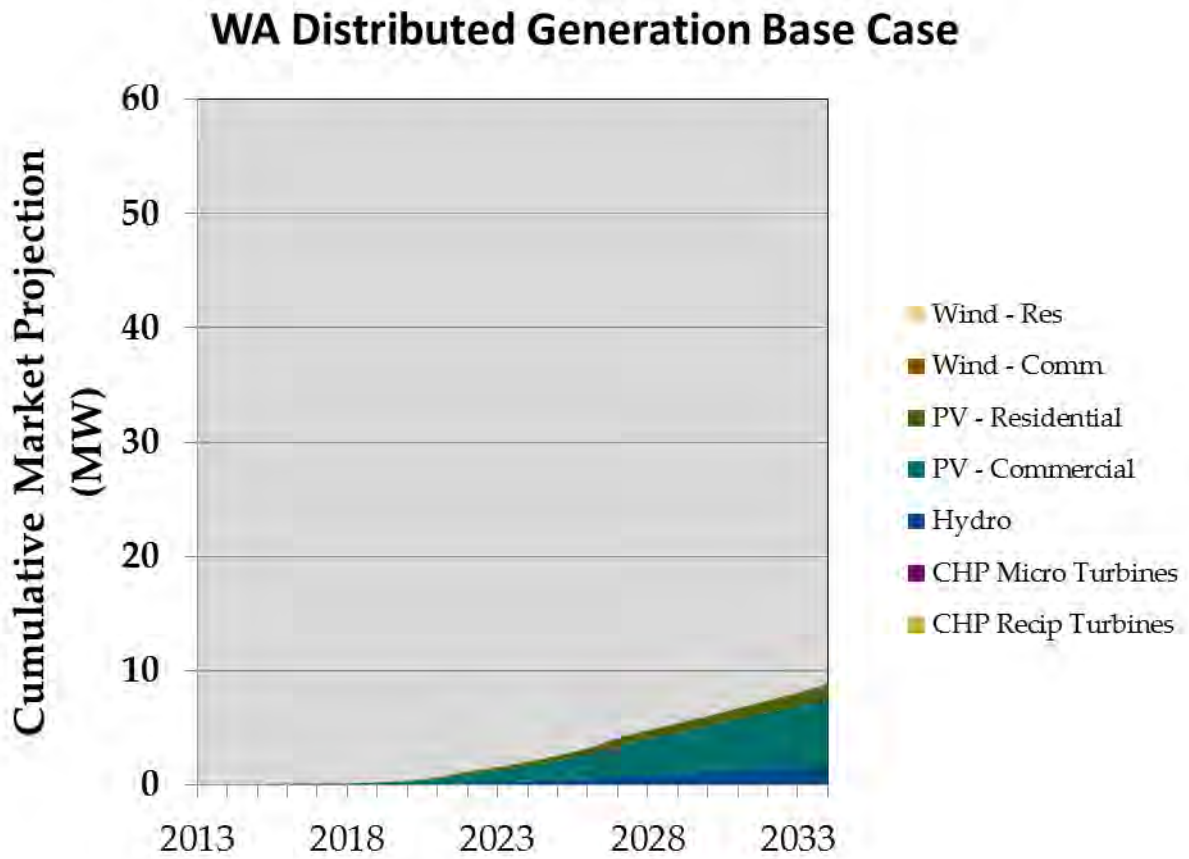

Wyoming is projected to achieve ~ 37 MW by 2034:

Figure 6-13. Wyoming Base Case Results

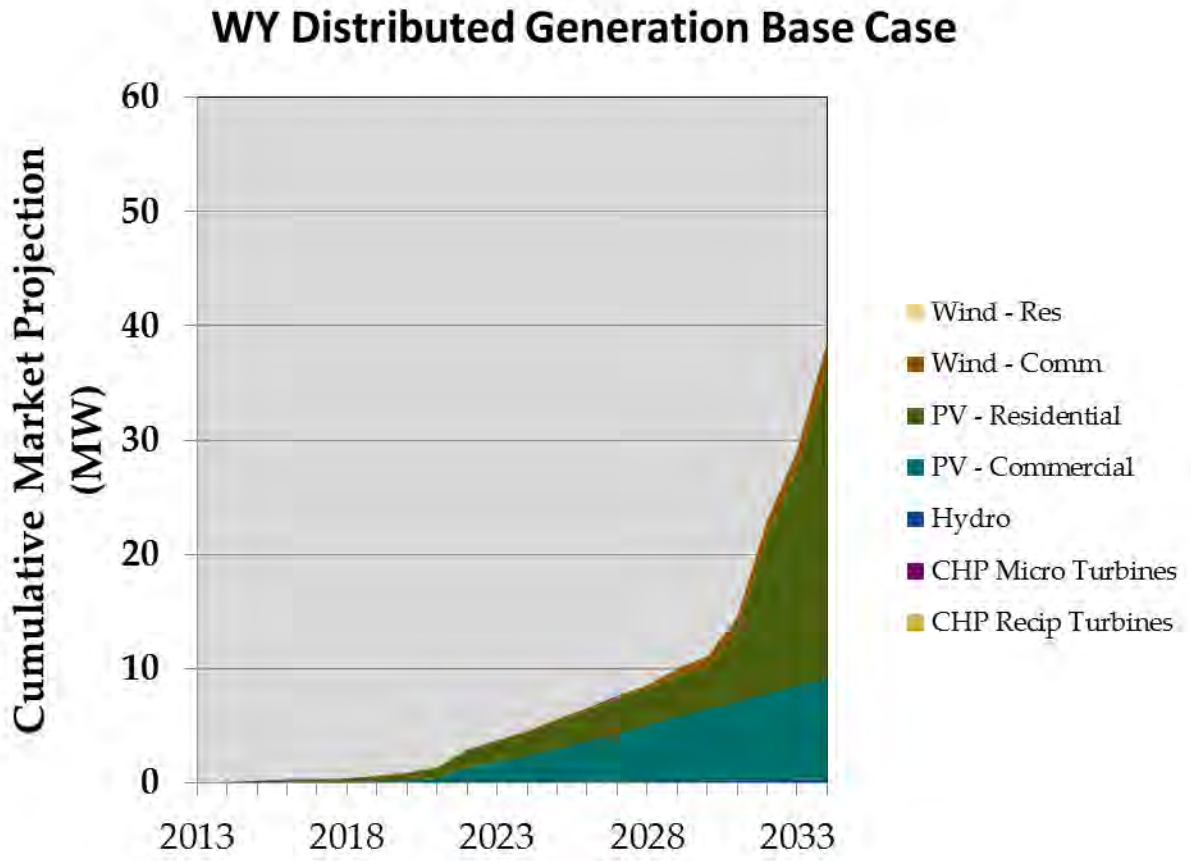

6.4 Results by Technology

Each technology is shown in turn.

Non-construction and non-standby power reciprocating engines will mostly occur in OR, CA, ID, and UT. Negligible penetration is projected for WY and WA⁵⁷.

Figure 6-14. Reciprocating Engines Base Case Results

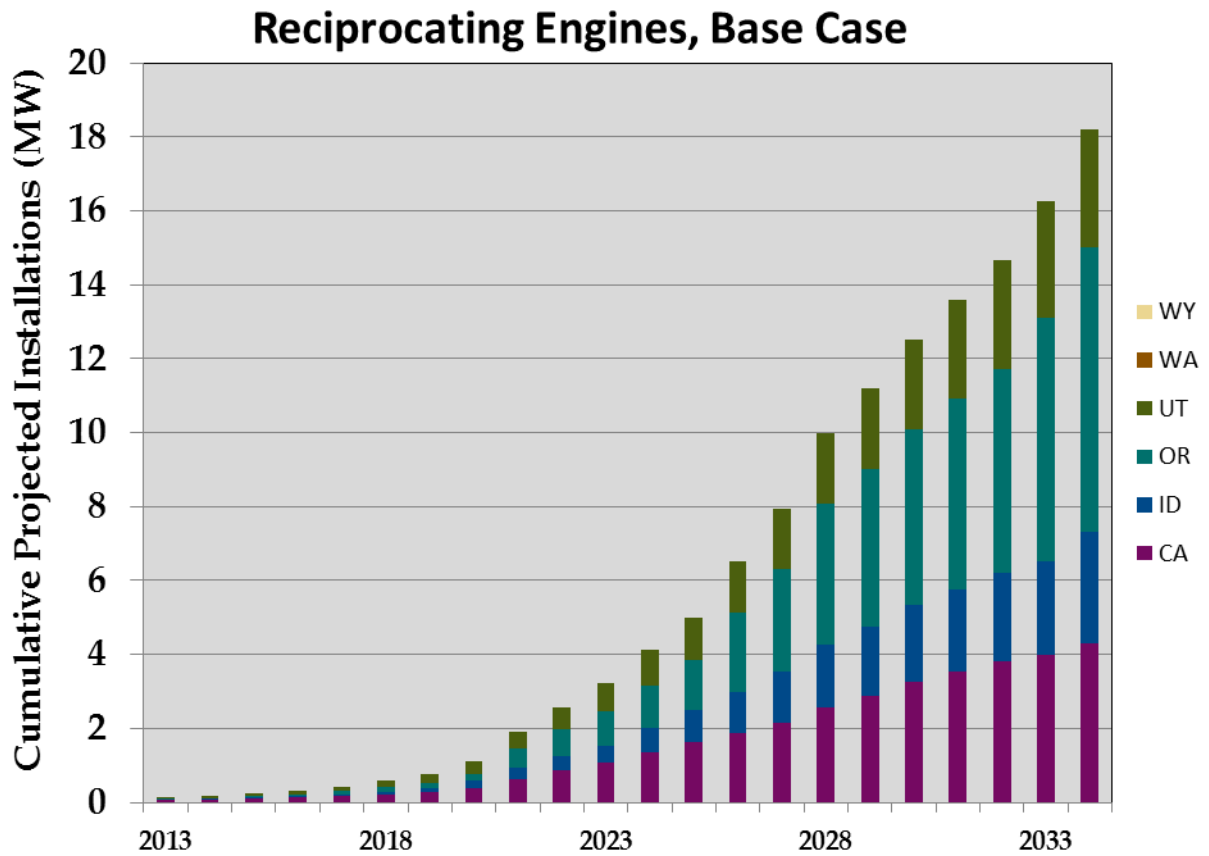

⁵⁷ Hence these are not showing as series in Figure 36.

As a relatively more expensive cousin of reciprocating engines, lower levels of penetration are projected in fewer states. Installations are projected to occur primarily in CA, ID, and OR.

Figure 6-15. Micro-turbines Base Case Results

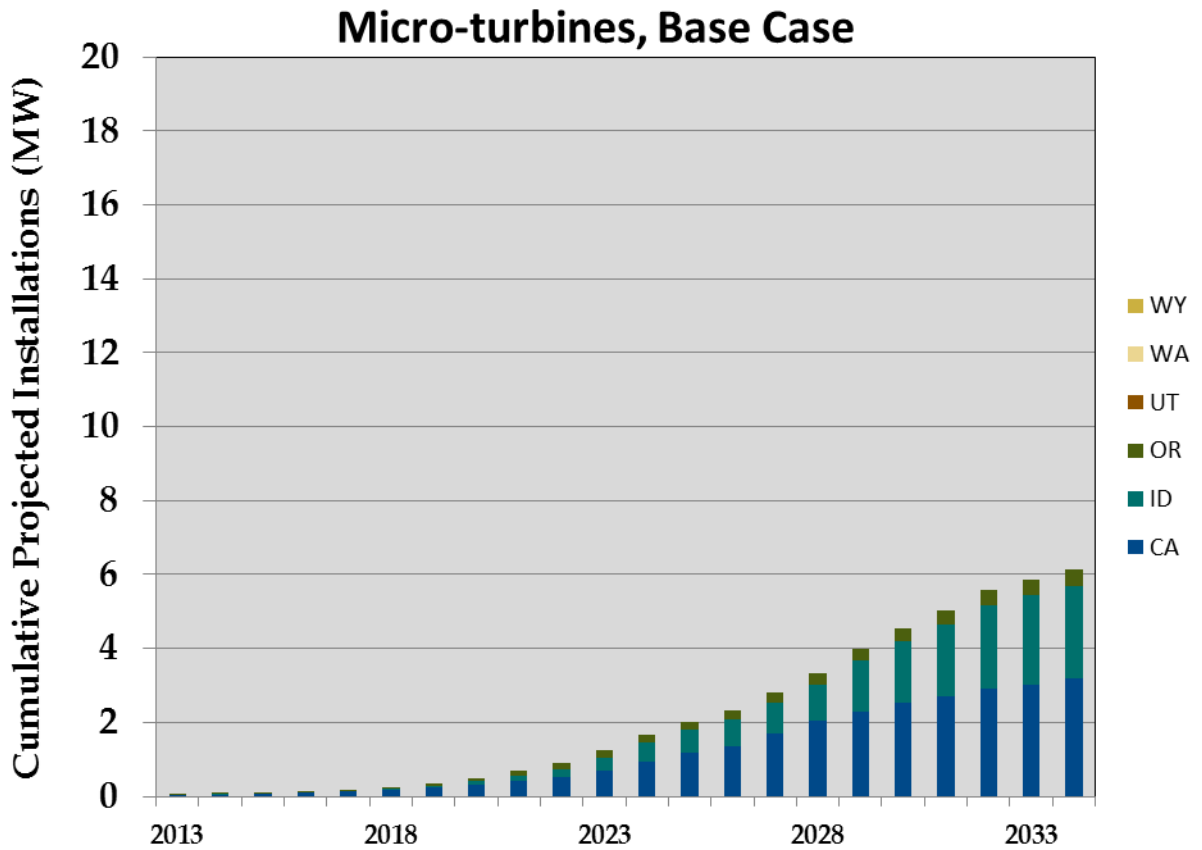

Small levels of small hydro penetration are likely to occur in some states -- WY, WA, UT, and OR. WA, and UT have higher technical potential, leading to slightly more penetration; Oregon, with the highest technical potential, achieves ~5 MW of penetration when current incentives expire in 2017, with little penetration thereafter.

Figure 6-16. Small Hydro Base Case Results

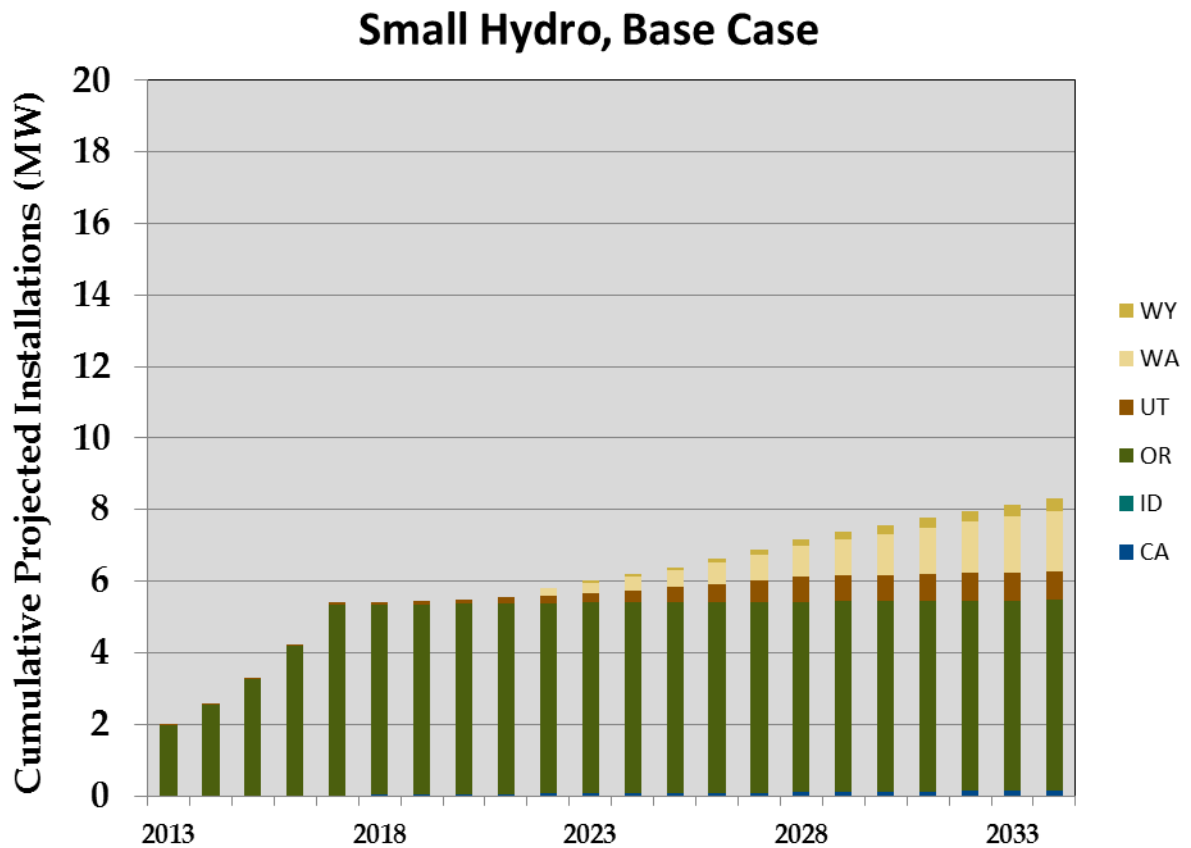

Due to higher residential electricity rates, and therefore lower payback periods, residential installations dominate PV projections, especially after 2022.

Figure 6-17. Photovoltaics Base Case Results

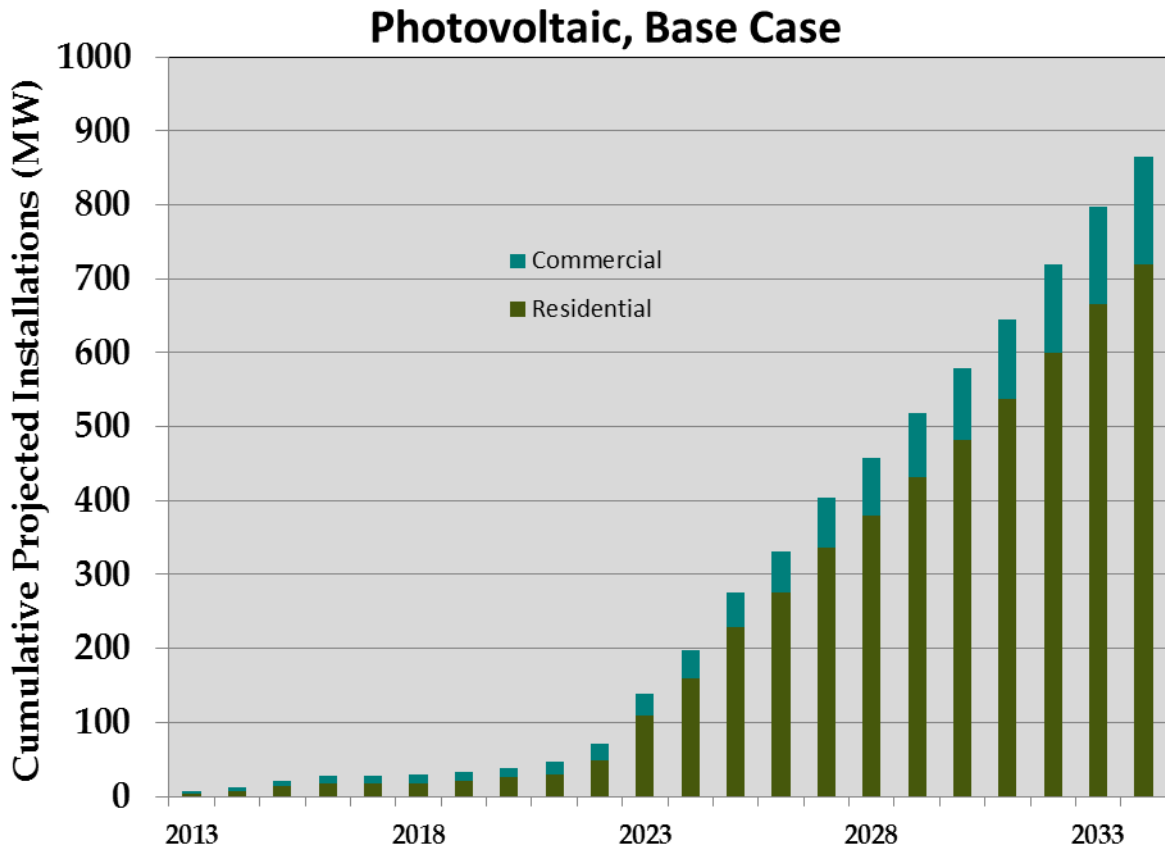

As shown below and in the Utah results above, most of this dramatic residential growth after 2022 is projected to occur in Utah, with continued incentives and continued cost reduction lowering payback residential payback periods.

Figure 6-18. Photovoltaics Residential Base Case Results

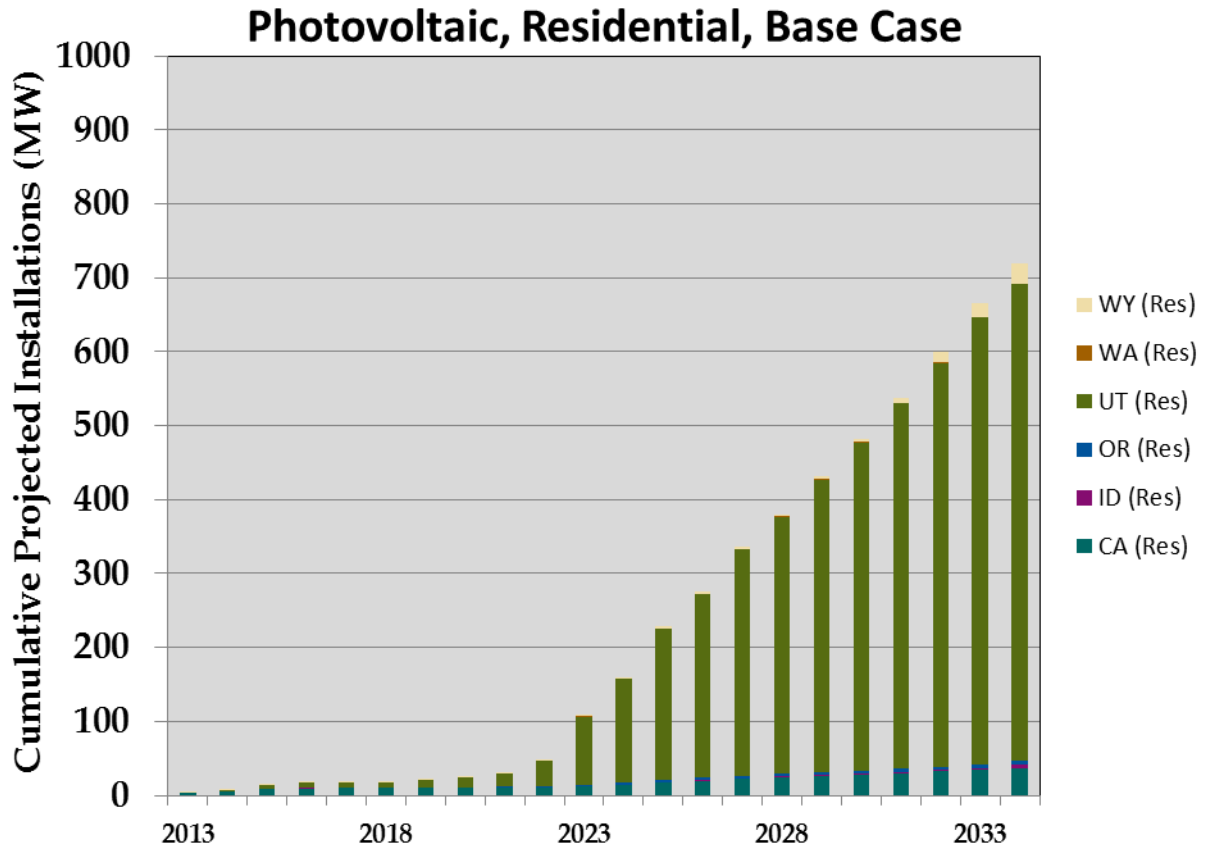

Commercial PV projections are much lower. Utah dominates due to higher incentives and its relatively large proportion of technical potential.

Figure 6-19. Photovoltaic Commercial Base Case Results

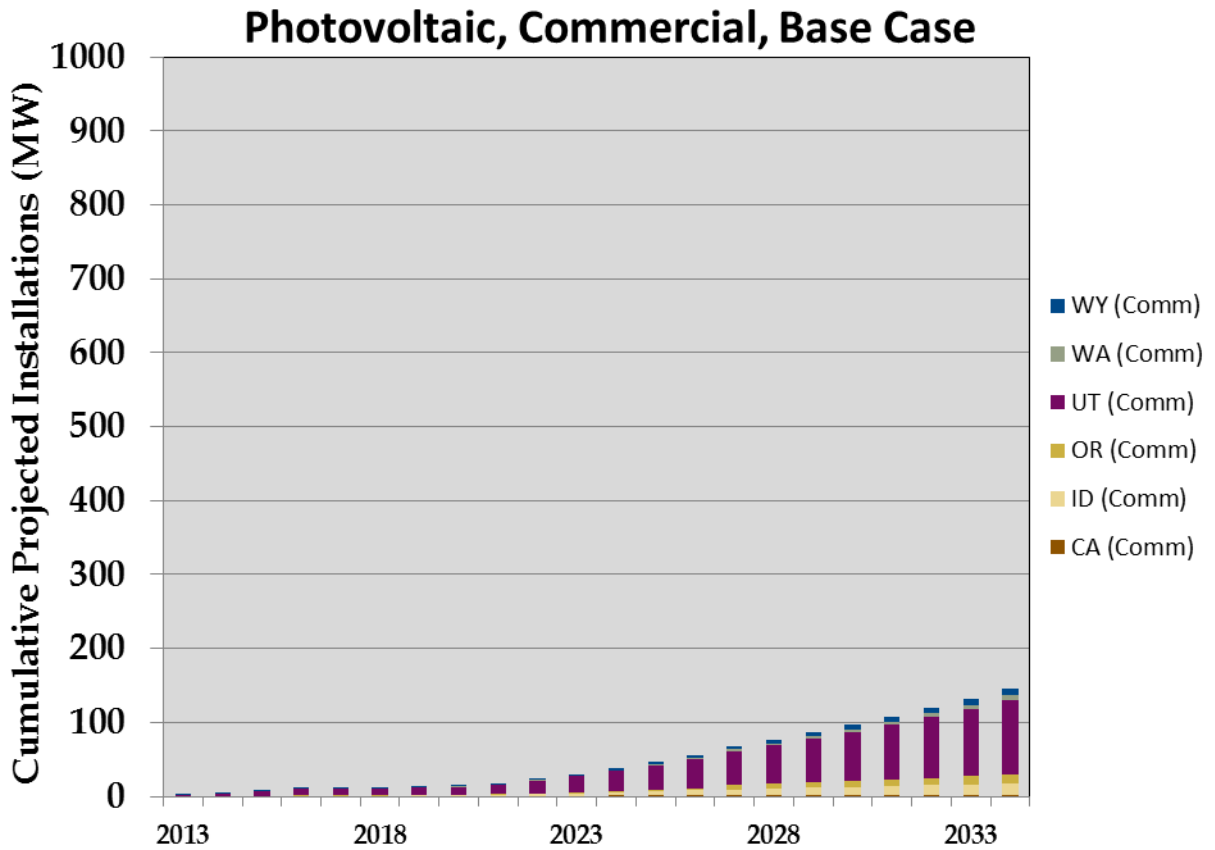

Residential small wind installations are projected to be more economic than commercial:

Figure 6-20. Small Wind Base Case Results

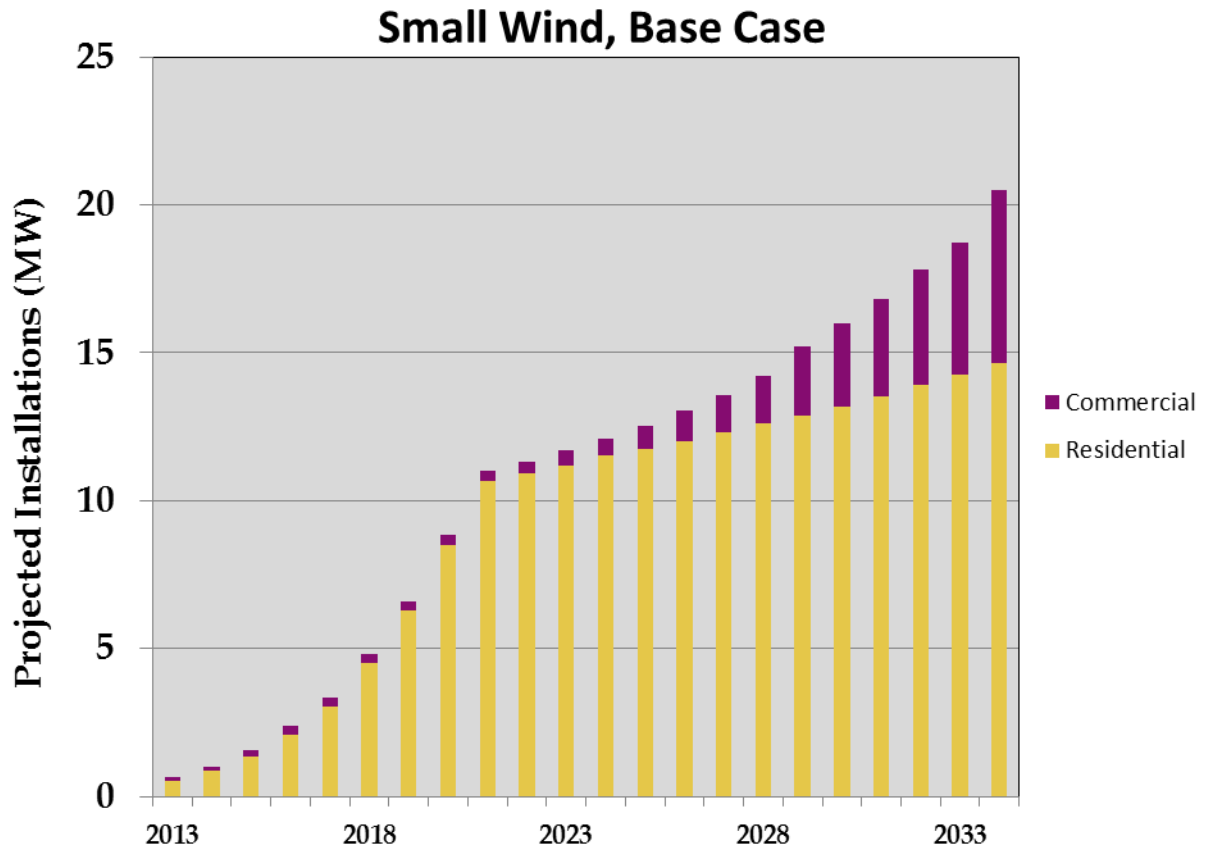

These are dominated by Oregon market penetration, which occurs largely due to an incentive that is projected to phase out by 2021.

Figure 6-21. Small Wind Residential Results

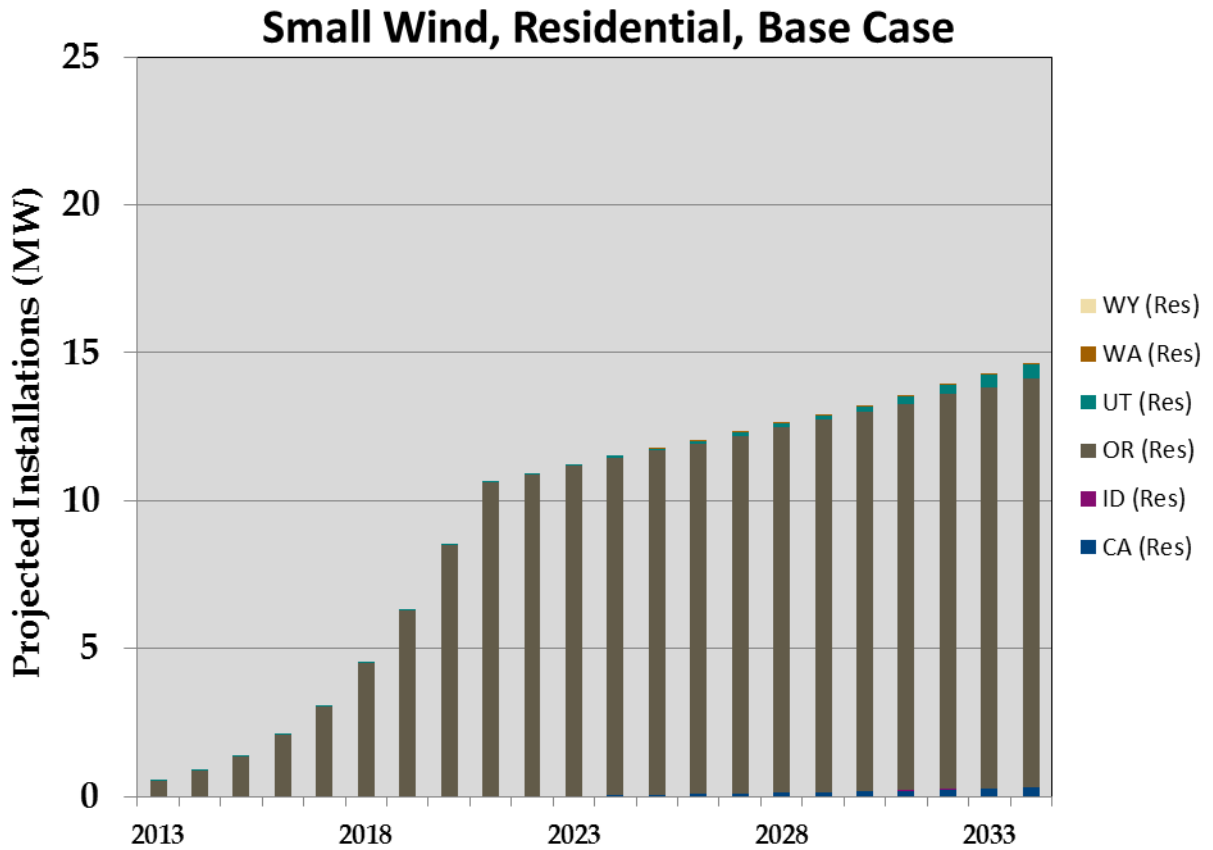

Commercial small scale wind is projected to be much smaller, with long payback periods:

Figure 6-22. Small Wind Commercial Results

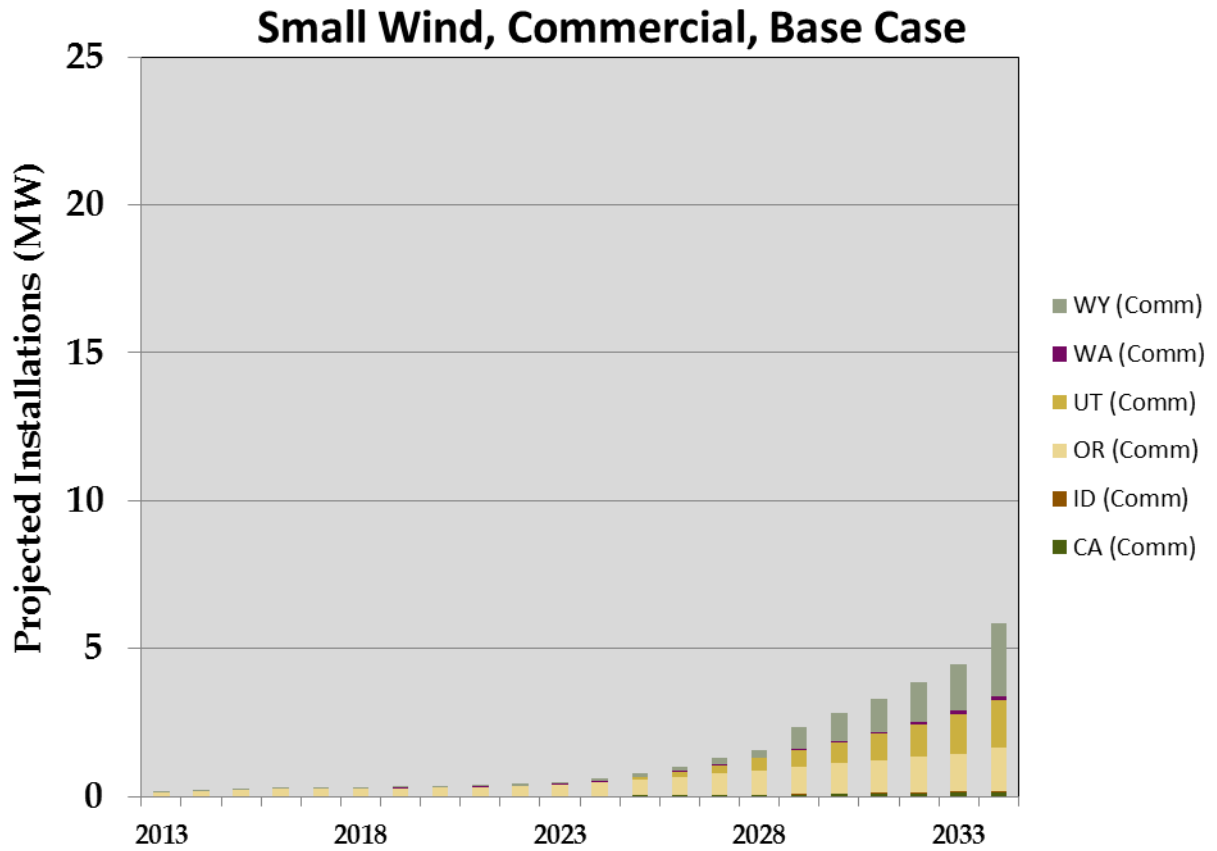

Appendix A. Glossary

\$/WpDC -- \$/ peak watt DC. Solar modules produce DC power which is then converted to AC by an inverter

CHP – Combined Heat and Power

DG - Distributed Generation – electricity sources that are purchased by the consumer

HAWT – Horizontal-axis wind turbine

IRP – Integrated Resource Plan

ITC – Investment Tax Credit

LCOE – Levelized Cost of Energy, a measure of the cost of electricity in \$/kWh

MW – Mega-watt, a measure of power

Net Meter – a regulation which allows the customer to feed excess power generated back into the grid

O&M – Operations and Maintenance costs

PV – Photovoltaic, or Solar, or Solar Electric (used interchangeably). A technology that generates electricity when a module is exposed to sunlight.

PV Array – multiple PV modules grouped together to generate power

PV Module – a 1-2 m² solar component that can be readily handled by 1-2 people which generates DC electricity (like a battery)

SWT – Small Wind Turbine

Solar Electric – Photovoltaic

Solar Thermal – an alternative PV technology which concentrates solar energy to raise the temperature of a heat transfer fluid

VAWT – Vertical-axis wind turbine

Appendix B. Summary Table of Results

Base Case (MW Projected)				
	2015	2020	2025	2030
CA	9.8	11.4	21.5	36.3
ID	0.4	1.8	7.9	16.0
OR	5.3	15.5	24.0	36.7
UT	9.9	24.7	239.3	513.4
WA	0.1	0.4	2.6	6.1
WY	0.2	0.9	5.6	11.1

Low Penetration Case (MW)				
	2015	2020	2025	2030
CA	8.0	8.8	10.1	12.3
ID	0.3	0.9	3.3	6.1
OR	3.9	12.6	17.2	21.2
UT	6.9	14.9	38.1	64.1
WA	0.0	0.2	0.9	1.9
WY	0.1	0.5	1.5	4.8

High Penetration Case (MW)				
	2015	2020	2025	2030
CA	12.2	14.7	45.7	74.8
ID	0.6	3.5	22.8	68.5
OR	6.6	19.9	43.0	99.5
UT	16.0	143.2	729.0	1347.2
WA	0.2	1.3	7.6	28.8
WY	0.3	3.1	42.1	109.4

APPENDIX P – ANAEROBIC DIGESTERS RESOURCE ASSESSMENT STUDY

Introduction

Harris Group Incorporated was engaged by PacifiCorp to assess the magnitude of the potential electrical power generation from dairy waste in the State of Washington. The purpose of the assessment is to evaluate the potential for inclusion of the dairy resource in PacifiCorp's 2015 Integrated Resource Plan.

Anaerobic Digesters Resource Assessment
for
PacifiCorp
Washington Service Territory

Prepared for



HARRIS GROUP INC.

Report 80306

June 26, 2014



**ANAEROBIC DIGESTERS RESOURCE ASSESSMENT
PACIFICORP WASHINGTON SERVICE TERRITORY**

Table of Contents

SECTION 1 – EXECUTIVE SUMMARY.....	1
Introduction.....	1
Resource Assessment Overview	1
PacifiCorp Service Territory.....	2
Washington Dairy Background	3
Observations and Conclusions.....	5
Section 2 – Digester Technology	5
Section 3 – Power Production Estimate.....	5
Section 4 – Environmental and Regulatory	6
Section 5 – Development Cost.....	6
Section 6 – Operating Costs.....	6
SECTION 2 – DIGESTER TECHNOLOGY	7
Dairy Based Digester Design.....	7
Manure Management	9
Biogas Production.....	9
Biogas Conditioning	10
Electrical Power Generation	11
Engines and Prime Movers	11
Heat Recovery Systems	11
Generators	11
Manure Effluent Management	11
Emission Control Systems	12
SECTION 3 – POWER PRODUCTION ESTIMATE.....	13
Quantifying Energy Potential from Dairies in PacifiCorp’s WA State Territory.....	13
Required Parameters for Quantifying Energy Potential	13
Methodology.....	14
Results.....	20
SECTION 4 – ENVIRONMENTAL AND REGULATORY	23
WA Solid Waste Permitting	23
WA Water Permitting	23
WA Air Permitting.....	23
Local Jurisdiction Permitting.....	23
REC Qualification.....	24
Other Investment Incentives	24
Greenhouse Gas Reduction.....	25
SECTION 5 – DEVELOPMENT COST	27

**ANAEROBIC DIGESTERS RESOURCE ASSESSMENT
PACIFICORP WASHINGTON SERVICE TERRITORY**

Table of Contents (continued)

Completed Major Equipment Revisions.....	27
SECTION 6 – OPERATING COSTS	29
Addition of Other Organic Wastes	29
George DeRuyter & Sons Dairy	30
APPENDIX 1.....	31

SECTION 1 – EXECUTIVE SUMMARY

Introduction

Harris Group Incorporated (“HGI”) has been engaged by PacifiCorp to assess the magnitude of the potential electrical power generation from dairy waste in the State of Washington. The purpose of the assessment is to evaluate the potential for inclusion of the dairy resource in PacifiCorp’s 2015 Integrated Resource Plan (“IRP”).

The 2013 IRP Acknowledgment Letter issued by the Washington Public Utilities Commission requested an analysis of the potential within PacifiCorp’s service territory for anaerobic digesters to provide power generation resources to be included in the IRP.

In this study HGI has included a technical analysis of the potential generation capacity based on a thorough review of the available information on the numbers and sizes of dairies within the PacifiCorp service territory. In addition, HGI has provided an analysis of the Renewable Energy Credit (“REC”) registration potential, greenhouse gas reduction potential, environmental permitting summary, capital investment estimate, and operating cost estimate. Other applications of anaerobic digestion that may exist within PacifiCorp’s service territory are beyond the scope of this report. Those other applications are not as readily identifiable or as concentrated as the dairy resources in the Yakima Valley. Other sources of organic feed are also not considered in this assessment due to their diverse nature, additional environmental permitting, and cost associated with the transportation over a large geographic area.

Resource Assessment Overview

Harris Group and professionals within HGI have significant experience in the development of anaerobic digester (“AD”) projects utilizing dairy manure as the primary substrate for biogas production. HGI has developed expertise in the following AD project related activities.

- ❑ Biogas Plant Process Design;
- ❑ Project Permitting;
- ❑ Detailed Plant Design;
- ❑ Power Generation and Interconnection;
- ❑ Power Purchase Agreements;
- ❑ Biogas Conditioning Process Design;
- ❑ Natural Gas Compression and Metering;
- ❑ Natural Gas Purchase Agreements;
- ❑ Resource Evaluation, and
- ❑ Plant Operations.

Harris Group has combined our own experience in the development of biogas projects with a thorough literature search that included collecting available data on farm locations and sizes from the State of Washington Departments of Agriculture and Ecology. Based on the available farm information HGI determined the numbers of farms that are located within PacifiCorp’s

service territory and began the process of evaluation of those resources and the potential to generate electrical power to satisfy power demand requirements in the service territory.

PacifiCorp Service Territory

PacifiCorp has service areas in the State of Washington that encompass a large concentration of dairies in the Yakima River Valley in Yakima County. A few of the dairies are located near the service territory in Benton County. PacifiCorp has additional service territories in the far southeast parts of the state that encompasses parts of Walla Walla, Columbia, and Garfield Counties. The State of Washington does not report any significant dairy operations in those counties. This report focuses on the dairies in Yakima County.

Figure 1-1 shows the locations of dairies in the State of Washington. Figure 1-2 shows the locations of dairies within PacifiCorp's service territories.

Figure 1-1: State of Washington Dairies

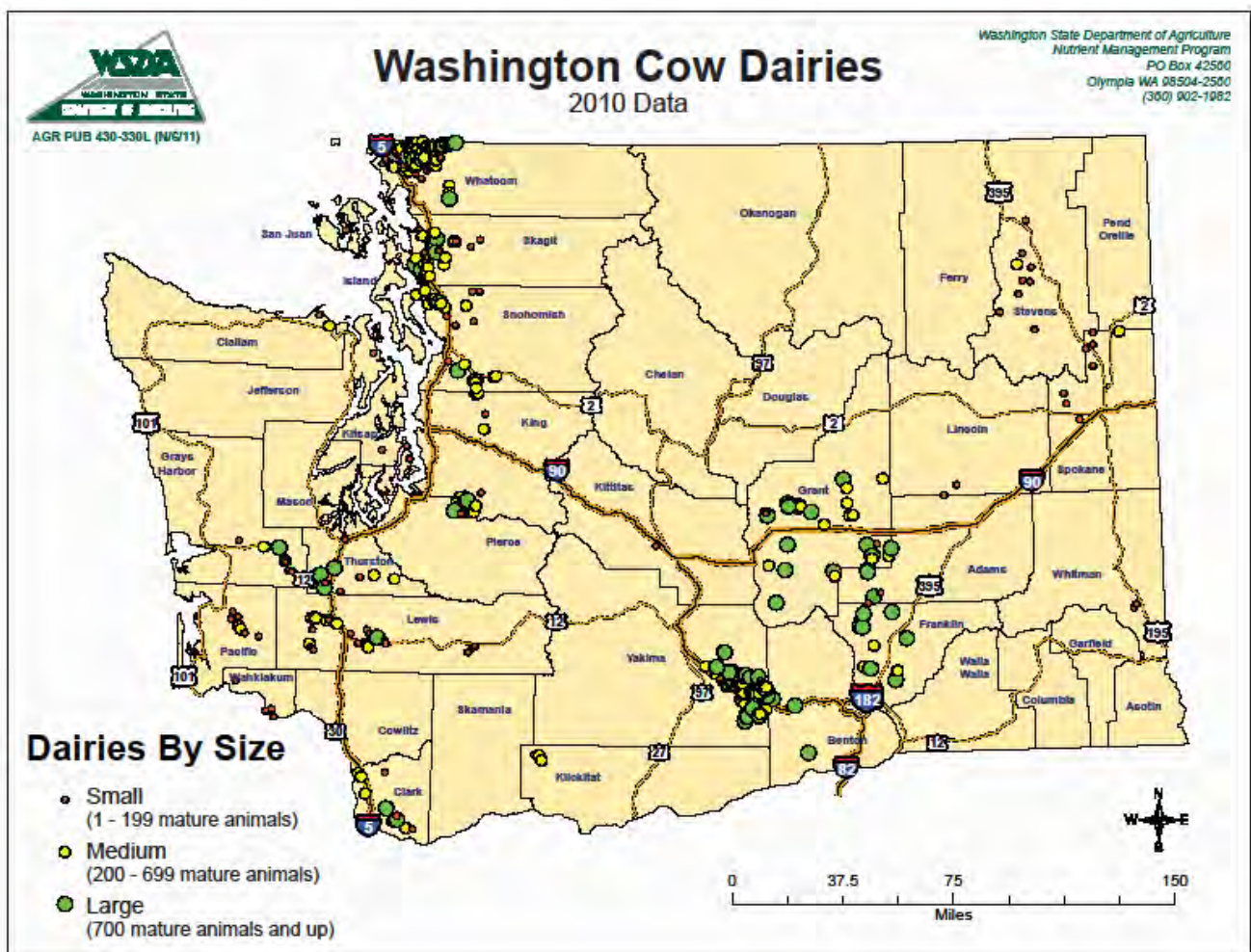
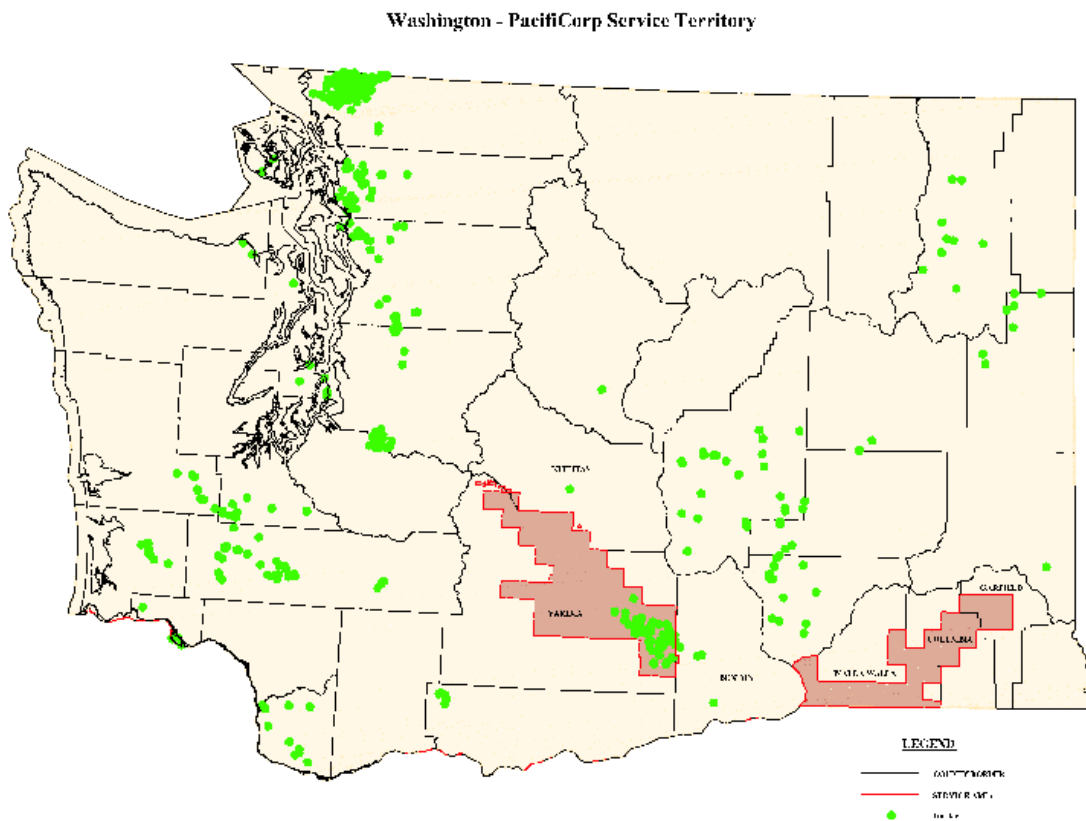

Figure 1-2: Dairies within the PacifiCorp Service Territory

Washington Dairy Background

The Washington State Department of Agriculture (“WSDA”) published a report in October 2011 that described the state of the dairy industry and a summary of dairy based digesters.¹ The report states that based on the 2010 registration data for WSDA Nutrient Management plans there are 443 commercial dairies in the State. Figure 1-3 taken from the report shows the size distribution of dairies based on the US EPA size categories developed under the Concentrated Animal Feeding Operation (“CAFO”) rules.

¹ WSDA Publication AGR PUB 602-343 (N/10/11) “Washington Dairies and Digesters”

Figure 1-3: Dairy Size Distribution in Washington

Source: WSDA, 2010 Registration

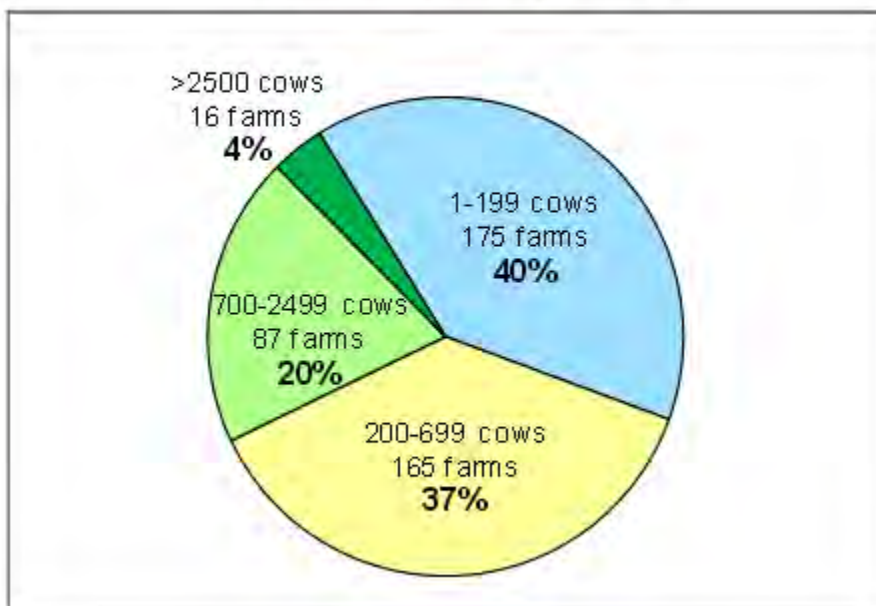

Milk is Washington's second most valuable agricultural commodity behind apples and ranks Washington as the 10th largest dairy producing state in the US. The report states that the trend in the US in all dairy producing states is towards consolidation into larger and larger farms that develop significant economies of scale to better manage production costs but at the same time concentrates animal wastes in smaller areas. Whatcom County is listed as home to the most dairies while Yakima County is home to largest number of dairy cows indicating a smaller number of larger farms.

The primary focus of this report is the two size ranges of farms shown as 700-2499 cows and greater than 2500 cows. These farms represent the portion of the dairy industry in Washington potentially capable of supporting AD development projects. The total represents approximately 24 percent of the dairies in Washington.

There are currently 10 different digesters in commercial operation in Washington all producing power that range in generator capacity from 400 to 1200 kW. The largest digester is operating in Yakima County at the George DeRuyter & Sons Dairy supplying 1200 kW of power to PacifiCorp. It is reported that all of the digesters operating in Washington add varying amounts of other organic material to the digesters to provide additional biogas for fuel. The State of Washington has enacted specific environmental regulations that allow the digesters to receive pre-consumer organic waste-derived materials under certain conditions without the need for obtaining a solid waste permit. The conditions require that no more than 30 percent of the feed material can come from organic wastes and the digester designs and operations must meet federal standards defined in the USDA Natural Resources Conservation Service Practice Standard 366, Anaerobic Digester. The majority of the digesters in Washington utilize digester technology provided by GHD, Inc, now operating as DVO, Inc.

Observations and Conclusions

The principal observations and opinions that we have reached during our assessment of digestion based power resources in Washington are set forth below.

Section 2 – Digester Technology

1. The use of anaerobic digesters as a combination of waste management and a source of renewable energy is a well developed technology. There has been significant growth in the use of digesters that utilize dairy waste as a feed material in the US over the last 20 years.
2. There are numerous federal and state programs that support the assessment and development of the technology. The State of Washington has a well developed regulatory and acceptance program.
3. There are four primary digester technologies in use in agricultural use.
 - Covered anaerobic lagoons
 - Fixed-film digester
 - Complete-mix digester
 - Plug flow digester
4. The plug flow technology is the predominant technology in use around the US and Washington.
5. The production of biogas is straight forward and the use of biogas as a fuel in reciprocating engines for power production does not pose a significant risk to resource development. Interconnection of those resources to the power grid can be completed without significant technical risk. There may be specific project locations or project capacities where system upgrades may be required.

Section 3 – Power Production Estimate

1. Power estimates have been made using accepted protocols that have been applied to an inventory of resources provided by the State of Washington.
2. The only dairy resources in Washington that are in the service territory maintained by PacifiCorp are in Yakima County. There may be a few dairies in Benton County near the service territory that could be considered.
3. If all of the dairies in Yakima County installed anaerobic digesters, the total installed power would range from approximately 16.0 MW to 26.6 MW. The annual energy production would range from approximately 129 GWh/yr to 214 GWh/yr and would avoid 310,000 to 514,000 tonnes of CO₂e emissions per year.
4. If the size of the AD systems was limited to 500 kW and larger, there are 11 potential projects that would total approximately 10.2 MW and produce approximately 82 GWh/yr and would avoid approximately 197,000 tonnes of CO₂e emissions per year.

Section 4 – Environmental and Regulatory

1. The State of Washington has a well developed and straight forward permit program that specifically addresses anaerobic digester development.
2. With the passage of Initiative 937 in 2006 the State of Washington passed a renewable energy standard that applies to PacifiCorp. The Renewable Portfolio Standard calls for electric utilities that serve more than 25,000 customers to obtain 15 percent of their power from renewable sources by the year 2020. Between January 1, 2012 through December 31, 2015 at least 3 percent of PacifiCorp's load must be supplied by renewable sources. For the period January 1, 2016 through December 31, 2019 the percentage increases to 9 percent. The increase to 15 percent must be met by January 1, 2020.
3. All of the generation that could be produced from AD projects with dairies in the Yakima County service territory would generate REC's that could be registered and traded.
4. REC's can be registered with WREGIS and traded within the WECC states. It is beyond the scope of this assessment to establish the market value of REC's traded within the region.

Section 5 – Development Cost

1. Development or capital costs for development of the resources are based on data provided by the US EPA AgStar Program.
2. The total capital investment estimate that would be required to develop 100 percent of the resources would be approximately \$91MM. It is not practical to assume that all projects rise to the level of investment quality. May of the smaller farms would not be practical.
3. Another way to consider the investment is to assume a unit cost per kilowatt of installed capacity to be \$3000 to \$3500. This figure would be applicable to systems from 500 kW to the maximum size project available in the county. This figure is consistent with Harris Group's experience with similar projects.

Section 6 – Operating Costs

1. Based on the data from the Natural Resources Conservation Service analysis and assuming a plug flow digester design it is estimated that the total operating costs for electrical production are \$0.09/kWh. The cost analysis is based on the operating results of nine different projects.
2. The development of AD projects on farms that depend solely on electrical revenue for profitability is not currently economically attractive in an area like Yakima County where wholesale rates for power are relatively low compared to other parts of the country. Projects that meet the requirements of a Qualifying Facility in accordance with the Washington Schedule 37 rates would also not be currently economically attractive based on the value of the power production alone. Projects must include the production and sale of other marketable by products such as compost to reduce the reliance on electrical revenues alone to develop successful projects. Projects must also monetize the value of REC's and Carbon Credits.

SECTION 2 – DIGESTER TECHNOLOGY

Dairy Based Digester Design

Large-scale anaerobic digesters in use on dairy farms in the USA fall into four classifications or types of digesters:

- ❑ Covered anaerobic lagoons with a hydraulic retention time (HRT) of 35 to 60 days. Ponds operate at ambient conditions, so gas yield is reduced in cool seasons (methane production is severely limited in cold climates). Variations incorporating sludge recycling or distributed inflow are referred to as enhanced covered anaerobic ponds.
- ❑ Fixed-film digester, usually heated, containing media that increase the surface area available for bacteria to adhere to, thus preventing washout. As more than 90 percent of the bacteria are attached to the media, an HRT of days, rather than weeks, is possible. Separation of fixed solids by settling and screening is necessary to prevent fouling.
- ❑ Complete-mix digester sometimes referred to as a continuously stirred tank reactor; usually a circular tank with mixing to prevent solids settling and to maintain contact between bacteria and organic matter. Mixing also maintains a uniform distribution of supplied heat.
- ❑ Plug flow digester, usually a long concrete tank where manure with as-excreted consistency is loaded at one end and flows in a plug to the other end. The digester is heated. Although it can have locally mixed zones, it is not mixed longitudinally.

The determination of which digestion technologies are appropriate for a given project depend on the project specific conditions. The majority of the digesters in use in Washington are of the modified plug flow type which includes mixing zones and the introduction of other organic wastes.

Figure 2-1 shows typical process flow diagram provided by the US EPA AgStar Program. The flow diagram is a good representation of the digestion process and includes other uses for energy and byproducts from the AD process.

Figure 2-1: Process Flow Diagram

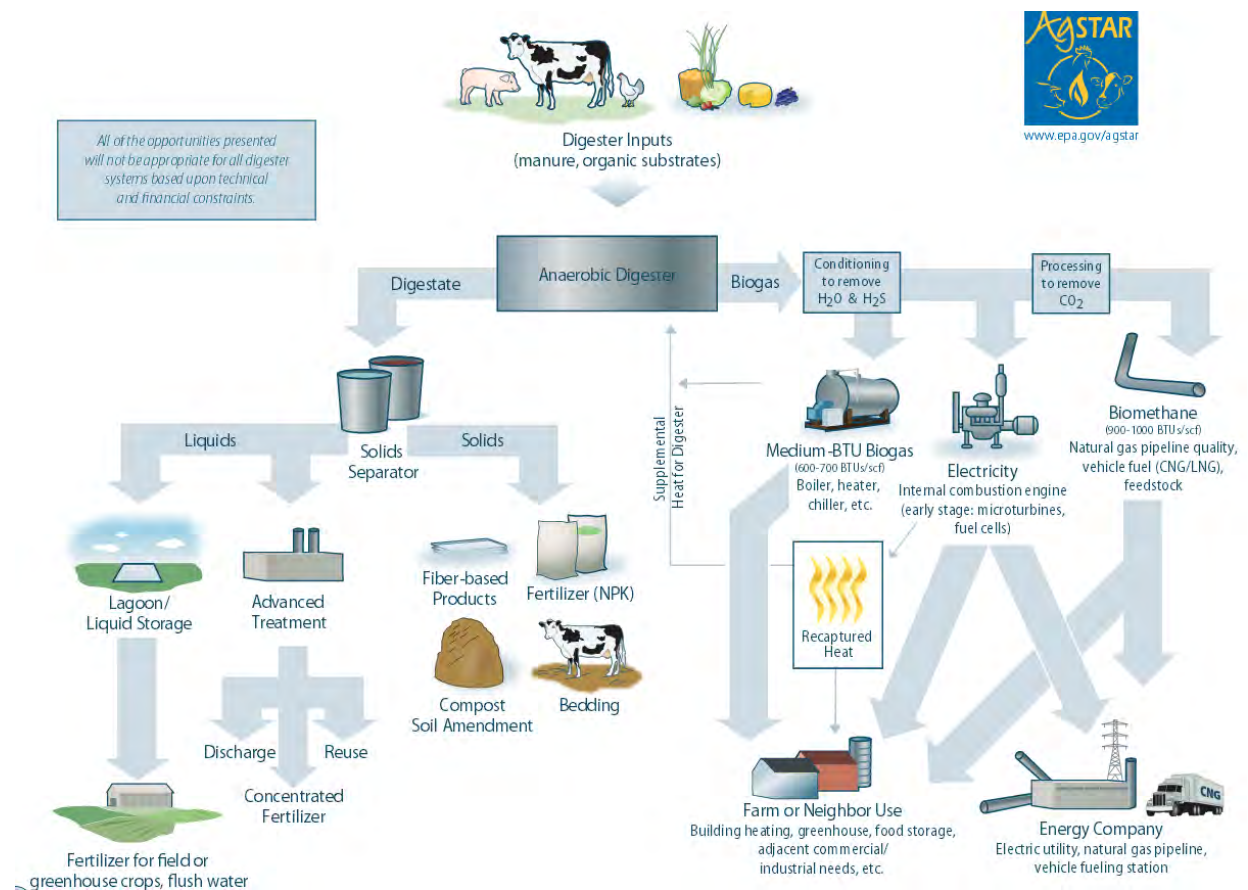
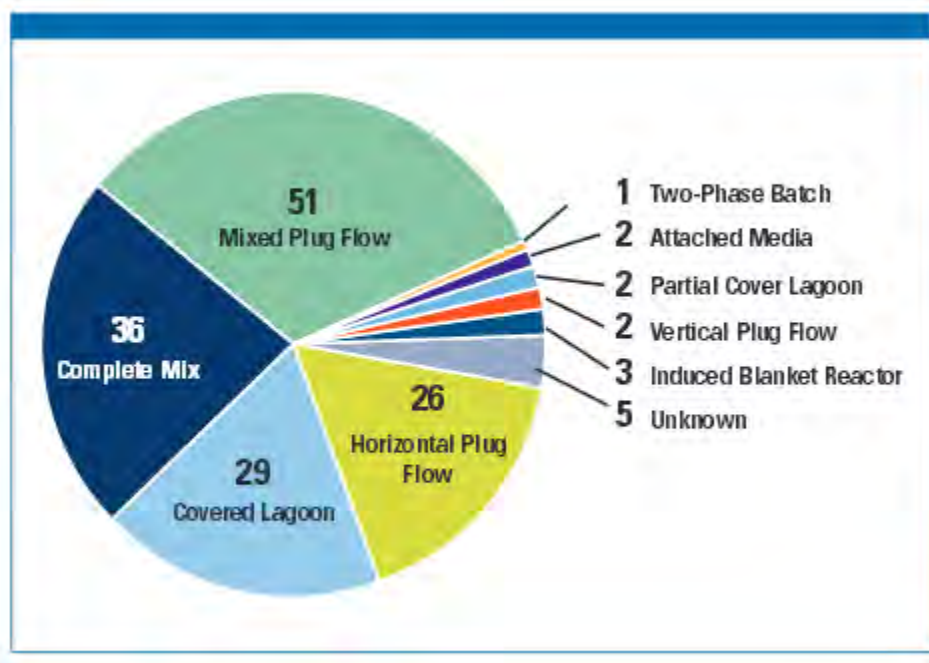

Figure 2-2 shows the relative distribution of digester types in use in the US. The mixed plug flow digester is the predominant technology. The two primary reasons for the popularity of the mixed plug flow digesters are lower capital costs and relative ease of operation. All of the digester technologies would produce a comparable quantity and quality of biogas fuel for generation.

Figure 2-2: Distribution of AD Technology in the US

Manure Management

Manure management practices have an impact on the cost of AD. Dairies use a variety of manure collection and storage methods. The herd management practices also have an impact on the quality and quantity of manure collected and processed. Lactating dairy herd management practices can be classified by two different housing methods.

- ❑ Dry Lot – Animals are allowed to loaf in large pens where manure is dropped over a large area and mixed with significant quantities of inert material.
- ❑ Free Stall – Animals are confined in free stall barns where manure drops in concrete lanes and is scraped or flushed to collection with small amounts of additional inert material.

Larger dairies also manage replacement herds and depending on the dairy the manure may be collected and included with the lactating herd waste or managed separately through composting. Flush dairies flush the feeding lanes with large quantities of water which dilutes the manure and adds significant volumes of water to the waste necessitating the use of larger digester systems. In all cases the amount and quality of manure collected will vary from dairy to dairy dictating the choice of digestion technology, digester capacity, pre treatment and concentration of manure streams, and sand and grit removal.

Biogas Production

Typical manure digester projects utilize a digester residence time of 20 to 30 days. Each day the manure output from the dairy is fed to the digester and an equal volume of digested manure is discharged for storage and eventual disposal. Many projects also separate the cellulosic fiber and compost that material for sale as a soil amendment or utilize the digested solids as bedding

in the barns. In any case the liquid fraction that contains the majority of the nutrients must be discharged. The predominant disposal practice in the US and other parts of the world is land application as fertilizer to cropland.

The biogas production is a biological process whereby complex organic compounds are degraded in two steps by two classes of microorganisms in the digester. In the first step, acidifying bacteria hydrolyze the organic compound into organic acids. In the second step, methanogenic bacteria convert the organic acids into methane and carbon dioxide. A typical composition of biogas from all sources is shown below.

Compound	Formula	%
Methane	CH ₄	50–75
Carbon dioxide	CO ₂	25–50
Nitrogen	N ₂	0–10
Hydrogen	H ₂	0–1
Hydrogen sulfide	H ₂ S	0–3
Oxygen	O ₂	0–0

The range of methane content for biogas derived from manure is typically 60 to 65 percent with the carbon dioxide at 35 to 40 percent.

The biogas production is not technology driven. The same total amount of biogas can be produced from any of the digester technologies. There are differences in the rate at which the gas is produced which drives some of the technology decisions. For purposes of this report we assume that regardless of the technology utilized, all of the farms in the Yakima River Valley would produce gas at the maximum potential based solely on the number of animals. This is an appropriate way to consider the maximum electrical potential in the PacifiCorp service territory. The limiting factor would be the actual size of the dairy. Smaller dairies may not have the capital resources to support the high costs to install the gas production and power generation equipment.

Biogas Conditioning

Based on the composition above the biogas should be conditioned prior to use as a combustion fuel to remove the hydrogen sulfide (H₂S). There are a number of cost effective technologies available to remove the H₂S.

- ❑ Iron Sponge
- ❑ Chemical/Biological External Scrubbers
- ❑ Internal Biological Removal in the Digester

In all cases it is desirable to remove the H₂S prior to combustion to reduce the sulfur dioxide emissions in the exhaust and to reduce corrosion in the exhaust components of the engine.

Electrical Power Generation

Systems that generate electricity from biogas consist of:

- ❑ an internal combustion engine (compression or spark ignition) or a micro-turbine,
- ❑ an optional heat recovery system,
- ❑ generator, and
- ❑ control system.

Engines and Prime Movers

In Europe it is a popular option to utilize compression ignition (converted diesel) internal combustion engines. Compression engines are also known as dual-fuel engines. A small amount of diesel (10%–20% of the amount needed for diesel operation alone) is mixed with the biogas before combustion. Dual-fuel engines offer an advantage during start-up and downtime as they can run on anywhere from 0 percent to 85 percent biogas.

The majority of the projects in the US utilize spark-ignition internal combustion engines. All of the major gas engine manufacturers supply standard engines rated for use with biogas as the fuel. Typical heat rates for these types of reciprocating engines range from 9,000 to 10,000 Btu/kWh. The online capacity factor for these engines can average 95 percent due to their inherent reliability provided adequate service and maintenance procedures are implemented.

Microturbines are not favored for use with raw biogas due to the dirty composition of the fuel which leads to reliability problems. Larger gas turbines are typically much larger than needed for biogas projects except for those projects that would produce in excess of 5 MW per project. One of the advantages that gas turbines have is a lower NO_x emission profile. For engines that utilize lean burn control technology the NO_x emission rate would range from 0.6 to 1.1 g/bhp-hr.

Heat Recovery Systems

Commercially available heat exchangers can recover heat from the engine water cooling system and exhaust. Typically, heat exchangers will recover around 0.8 kWh of heat per kWh of electrical output from the engine jacket and 0.75 kWh from the exhaust, increasing total (electrical plus thermal) energy efficiency to 65 to 80 percent. The heat is generally used for maintaining the digester temperatures, building heat, and in some cases providing refrigeration for milk cooling.

Generators

Generators typically run in parallel with the utility interconnection and export power in synchronization with the grid. The engine/generator sets are supplied by competent well known manufacturers that package complete systems with reliable controls to manage the power export to the interconnection and grid.

Manure Effluent Management

Digested manure can be further processed to separate fibrous solids for compost or animal bedding. Separation also impacts the distribution of nutrients that must be managed under

Nutrient Management Plans (“NMP”). Phosphorus will be largely distributed in the separated solids while nitrogen will be largely distributed in the liquid. The NMP is a management system that limits the amount of nutrient that can be applied to crop land to that fraction that can be utilized by growing crops. The limits are established to control excess nutrients that migrate to surface water and ground water systems. Digested manure reduces the organic fraction of those nutrients that are not in a form that can be utilized by crops in the current application year. The inorganic forms of nutrients in digested manure is more likely to be utilized by growing crops at the time of application and not accumulate and contaminate water sources. Ultimately manure whether it’s digested or not is land applied for disposal.

Emission Control Systems

Typical air emission controls include flares for excess biogas and engines that utilize lean burn carburetion for NO_x and CO control. Permitting for these emissions is a relatively straight forward process with low risk for negative outcomes.

SECTION 3 – POWER PRODUCTION ESTIMATE

Quantifying Energy Potential from Dairies in PacifiCorp’s WA State Territory

There are numerous anaerobic digestion (“AD”) technologies available, and each technology provider has its own proprietary calculation to determine the potential energy production from a given mass of manure. In order to avoid publishing proprietary data, a method to calculate energy potential was chosen that is based on an industry accepted methodology for calculating the biomethane production from dairy cow manure. It is based on the *U.S. Livestock Project Protocol, Version 4.0* (the “Protocol”) published by the Climate Action Reserve and relies heavily on years of research and other calculation protocols, most notably the Intergovernmental Panel on Climate Change Protocol for calculating Greenhouse Gas Emissions from Livestock Waste. The calculations provided in this protocol are derived from internationally accepted methodologies.²

Required Parameters for Quantifying Energy Potential

The following parameters are necessary to quantify the energy potential:

Population – P_L

The Protocol differentiates between livestock categories (L) (e.g. lactating dairy cows, dry cows, heifers, etc.). This accounts for differences in methane generation across livestock categories.

Volatile solids – VS_L

The Volatile Solids (“VS”) represents the daily organic material in the manure for each livestock category and consists of both biodegradable and non-biodegradable fractions. The VS content of manure is a combination of excreted fecal material and urinary excretions, expressed in a dry matter weight basis (kg/animal).³

Mass $_L$

This value is the annual average live weight of the animals, per livestock category. This data is necessary because default VS values are supplied in units of kg/day/1,000 kg mass. Therefore, the average mass of the corresponding livestock category is required in order to convert the units of VS into kg/day/animal. Site specific livestock mass is preferred for all livestock categories. Since site-specific data is unavailable, Typical Animal Mass (“TAM”) values were used.

Maximum methane production – $B_{0,L}$

This value represents the maximum methane-producing capacity of the manure, differentiated by livestock category (L) and diet. Again, because site specific data is not available, this calculation uses the default B_0 factors supplied as part of the Protocol.

² The Reserve’s GHG reduction calculation method is derived from the Kyoto Protocol’s Clean Development Mechanism (ACM0010 V.5), the EPA’s Climate Leaders Program (Manure Offset Protocol, August 2008), and the RGGI Model Rule (January 5, 2007).

³ IPCC 2006 Guidelines volume 4, chapter 10, p. 10.42.

MS

The MS value estimates the fraction of total manure produced from each livestock category that is collected and delivered to the anaerobic digestion system. It is expressed as a percent (%), relative to the total amount of VS produced by the livestock category. Different manure management systems have different MS values. For example, a freestall barn system has an MS value of 0.95, whereas a drylot system has an MS value of 0.60.

Methane conversion factor – MCF

Each anaerobic digestion technology has a volatile solids-to-methane conversion efficiency that represents the degree to which maximum methane production (B₀) is achieved and is a function of the temperature and retention time of organic material in the system.⁴ This method to calculate methane conversion from VS reflects the performance of the anaerobic digestion system using the van't Hoff-Arrhenius equation, farm-level data on temperature, VS loading rate, and VS retention time.⁵

Methodology

The following summarizes the steps to calculate the potential energy production:

1. Determine total manure produced from the dairies
2. Calculate the volatile solids available in for anaerobic digestion
3. Calculate the conversion of volatile solids to biomethane
4. Calculate the conversion of biomethane to electricity

Step 1: Determine Total Manure Production

Data on cow numbers for specific dairies is not publicly available. However, the Washington Department of Agriculture maintains a database of dairies in the state that have nutrient management plans. This database is publicly available and, while it does not contain specific data on the number of cows at each dairy, it provides a range for the numbers of mature dairy cows and heifers at each dairy. This data was overlaid on the map of PacifiCorp's service territory in Washington State. This results in 60 dairies that are consolidated into eight different size categories based on the number of mature cows on site (see Table 3-1).

⁴ IPCC 2006 Guidelines volume 4, chapter 10, p. 10.43.

⁵ The method is derived from Mangino et al., "Development of a Methane Conversion Factor to Estimate Emissions from Animal Waste Lagoons" (2001).

<u>Mature Cows</u>	<u>Number of Dairies</u>
38 to 199	2
200 to 699	15
700 to 1699	22
1700 to 2699	11
2700 to 3699	2
3700 to 4699	4
5700 to 6839	2
6840 and above	2
Total:	60

For each dairy, there is a range of the number of mature cows and heifers. This data was used to derive a range of the daily amount of manure for each dairy. Depending on their size, feed, and lactation status, different types of cows produce varying amounts of manure. The Protocol uses industry accepted values of TAM to estimate the daily manure produce for each livestock category (L) (see Table 3-2).

Table 3-2: Typical Animal Mass for each Livestock Category

<u>Livestock Category (L)</u>	Livestock Typical Animal Mass (TAM) in kg	
	<u>2006-2008</u>	<u>2009-2010</u>
Dairy cows (on feed)	604 ^b	680 ^c
Non-milking dairy cows (on feed)	684 ^a	684 ^a
Heifers (on feed)	476 ^b	407 ^c
Bulls (grazing)	750 ^b	750 ^c
Calves (grazing)	118 ^b	118 ^c
Heifers (grazing)	420 ^b	351 ^c
Cows (grazing)	533 ^b	582.5 ^c
Nursery swine	12.5 ^a	12.5 ^a
Grow/finish swine	70 ^a	70 ^a
Breeding swine	198 ^b	198 ^c

Sources for TAM:

^a American Society of Agricultural Engineers (ASAE) Standards 2005, ASAE D384.2.

^b Environmental Protection Agency (EPA), Inventory of US GHG Emissions and Sinks 1990-2006 (2007), Annex 3, Table A-161, pg. A-195.

^c Environmental Protection Agency (EPA), Inventory of US GHG Emissions and Sinks 1990-2010 (2012), Annex 3, Table A-191, pg. A-246.

Step 2: Calculate the Volatile Solids Available for Digestion

Consistent with the Protocol, appropriate VS_L values for dairy livestock categories were obtained from the state-specific lookup tables available through the Climate Action Reserve. The VS_L values for lactating cows, mature dry cows, and heifers are shown in Table 3-3.

Table 3-3: Daily Volatile Solids Production for each Livestock Category	
<u>Livestock Category (L)</u>	<u>VS_L</u> <u>(kg/day/1000 kg mass)</u>
Dairy cows	11.50 ^a
Non-milking dairy cows	11.50 ^a
Heifers	8.43 ^a
Bulls (grazing)	6.04 ^b
Calves (grazing)	6.41 ^b
Heifers (grazing)	8.25 ^a
Cows (grazing)	7.82 ^a
Nursery swine	8.89 ^b
Grow/finish swine	5.36 ^b
Breeding swine	2.71 ^b
^a Environmental Protection Agency (EPA) - U.S Inventory of Greenhouse Gas Sources and Sinks, 1990-2012 (2013), Annex 3, Table A-204. ^b Environmental Protection Agency (EPA) – Climate Leaders Draft Manure Offset Protocol, October 2006, Table IIa: Animal Waste Characteristics , p. 18.	

In order to arrive at VS_L in the appropriate units (kg/animal/day), Equation 3.1 is used:

$$VS_L = VS_{Table} \times Mass_L / 1,000 \quad (Equation\ 3.1)$$

Where:

- VS_L = Volatile solid excretion on a dry matter weight basis,
kg/animal/day
- VS_{Table} = Volatile solid excretion from Climate Action Reserve lookup table,
from Table 3, kg/day/1000kg
- Mass_L = Average live weight for livestock category L from Table 2 , kg

The VS_L is then converted into the monthly amount of VS available from each dairy by applying the population and manure management factors arrived at previously, using Equation 3.2. Because the dairies in the study area predominately utilize drylot manure management systems, the MS_L for all livestock categories is 0.60, meaning that 60 percent of the total manure produced is collected and could be delivered to an AD system.

$$VS_{avail, L} = (VS_L \times P_L \times MS_L \times days_{mo}) \quad (\text{Equation 3.2})$$

Where:

$VS_{avail, L}$	=	Monthly volatile solids available for the anaerobic digestion system by livestock category L , <i>kg dry matter</i>
VS_L	=	Volatile solids produced by livestock category L on a dry matter basis, <i>kg/animal/day</i>
P_L	=	Average population of livestock category L
MS_L	=	Percent of manure produced by each livestock category L , that is collected in the manure management system and delivered to the AD system, %
$days_{mo}$	=	Calendar days per month, <i>days</i>

Step 3: Calculate the Conversion of Volatile Solids to Biomethane

Now that the VS that are delivered to the AD system are known, the amount of methane that can be generated from those VS via anaerobic processes must be calculated. This is accomplished by multiplying the $B_{0,L}$, the maximum methane capacity for each livestock category, by VS_{deg} , the amount of the VS delivered to the AD system (calculated in Equation 3.2) that is degraded and converted to methane (see Equation 3.3). The $B_{0,L}$ for each livestock category is derived from empirical data (see Table 3-4). The VS_{deg} is a function of the total VS_{avail} and the ' f ' factor, which incorporates the van't Hoff-Arrhenius equation described previously.

$$BE_{CH_4, L} = (VS_{deg, L} \times B_{0,L} \times days_{mo}) \quad (\text{Equation 3.3})$$

Where:

$BE_{CH_4, L}$	=	Total monthly baseline methane emissions from anaerobic manure storage/treatment system AS from livestock category L , $m^3 CH_4/mo$
$VS_{deg, L}$	=	Monthly volatile solids degraded in AD system for livestock category L , <i>kg dry matter</i>
$B_{0,L}$	=	Maximum methane producing capacity of manure for livestock category L – see Table 4 for default values, $m^3 CH_4/kg$ of VS
$days_{mo}$	=	Calendar days per month, <i>days</i>

Table 3-4: Maximum Methane Production for each Livestock Category	
<u>Livestock Category (L)</u>	<u>B_{0,L}^a</u> <u>(m³ CH₄/kg VS added)</u>
Dairy cows	0.24
Non-milking dairy cows	0.24
Heifers	0.17
Bulls (grazing)	0.17
Calves (grazing)	0.17
Heifers (grazing)	0.17
Cows (grazing)	0.17
Nursery swine	0.48
Grow/finish swine	0.48
Breeding swine	0.35

^a Environmental Protection Agency (EPA) – Climate Leaders Draft Manure Offset Protocol, October 2006, Table IIa: Animal Waste Characteristics , p. 18.

$$VS_{deg, L} = \sum_L (VS_{avail, L} \times f) \quad (\text{Equation 3.4})$$

Where:

- $VS_{deg, L}$ = Monthly volatile solids degraded by AD system by livestock category L , *kg dry matter*
- $VS_{avail, L}$ = Monthly volatile solids available for degradation AD system by livestock category L , *kg dry matter*
- f = The van't Hoff-Arrhenius factor = “the proportion of volatile solids that are biologically available for conversion to methane based on the monthly temperature of the system”⁶

The ' f ' factor (see Equation 3.5) converts total available volatile solids in the AD system to methane-convertible volatile solids, based on the monthly temperature of the AD system. For heated AD systems that operate at either mesophilic (35–40°C) or thermophilic (50–60°C) temperatures, the ' f ' factor is at the maximum value of 0.95. The ' f ' factor comes into play only for AD systems that are significantly influenced by ambient temperatures (e.g. covered lagoons). It is assumed that the AD systems that are being contemplated in the study area are either mesophilic or thermophilic. Thus, the ' f ' factor is 0.95.

⁶ Mangino, et al.

$$f = \exp[E(T_{mo} - T_{ref})/(R \times T_{ref} \times T_{mo})] \quad (\text{Equation 3.5})$$

Where:

f	=	The van't Hoff-Arrhenius factor
E	=	Activation energy constant (15,175), <i>cal/mol</i>
T_{mo}	=	Monthly average AD system temperature (K = °C + 273). If $T_{mo} < 5^{\circ}\text{C}$ then $f = 0.104$. If $T_{mo} > 29.5^{\circ}\text{C}$ then $f = 0.95$, <i>Kelvin</i>
T_{ref}	=	303.16; Reference temperature for calculation, <i>Kelvin</i>
R	=	Ideal gas constant (1.987), <i>cal/Kmol</i>

The result of Equation 3.3 is the volume (in m^3) of biomethane per month from each dairy that results in the collection delivery and anaerobic digestion of the manure-derived volatile solids.

Step 4: Calculate the Conversion of Biomethane to Electricity

For the volumes of biomethane that can be generated via the AD systems that are being considered for the dairies in the study area, the most appropriate biomethane-to-electricity conversion technology is a reciprocating engine-generator. While the electrical conversion efficiencies of reciprocating engine-generators generally increase in size, they vary by manufacturer. Therefore, rather than attempting to predict a conversion efficiency for each size of dairy, a first approximation of 37.5 percent was used as an electrical conversion efficiency for each size of AD system. This was used to calculate the electrical power production for each dairy, based on its calculated volume of biomethane.

In addition, to arrive at the annual electrical energy production, it was assumed that each engine-generator was operating at the equivalent of full capacity for 90 percent of the hours each year.

Results

Based on the dairy data provided by the Washington Department of Agriculture and the methodology described above, Table 3-5 summarizes the potential electrical power production from the dairies. If all of the dairies installed anaerobic digesters, the total installed power would range from approximately 16.0 MW to 26.6 MW. The annual energy production would range from approximately 129 GWh/yr to 214 GWh/yr. These ranges are based on the range of dairy sizes.

Table 3-5: Electrical Power Production Ranges by Dairy Size

<u>Mature Cows</u>	<u>Number of Dairies</u>	<u>Minimum Power (kW)</u>	<u>Maximum Power (kW)</u>	<u>Average Power (kW)</u>
38 to 199	2	8	38	23
200 to 699	15	47	151	99
700 to 1699	22	143	248	246
1700 to 2699	11	322	520	421
2700 to 3699	2	576	779	677
3700 to 4699	4	679	894	787
5700 to 6839	2	1,102	1,345	1,221
6840 and above	2	1,242	1,509	1,375
Total:	60	15,971	26,576	21,273

Because the economics of installing digesters on smaller dairies may not be favorable, another useful way to view the potential is by grouping the engine-gensets by size. Figure 3-1 summarizes this information, based on the average number of mature dairy cows within each of the dairy size categories. If the size of the AD systems were limited to 500 kW and larger, there are 11 potential projects that would total approximately 10.2 MW and produce approximately 82 GWh/yr.

Figure 3-1: Potential Annual Electricity Production from Dairy AD Systems

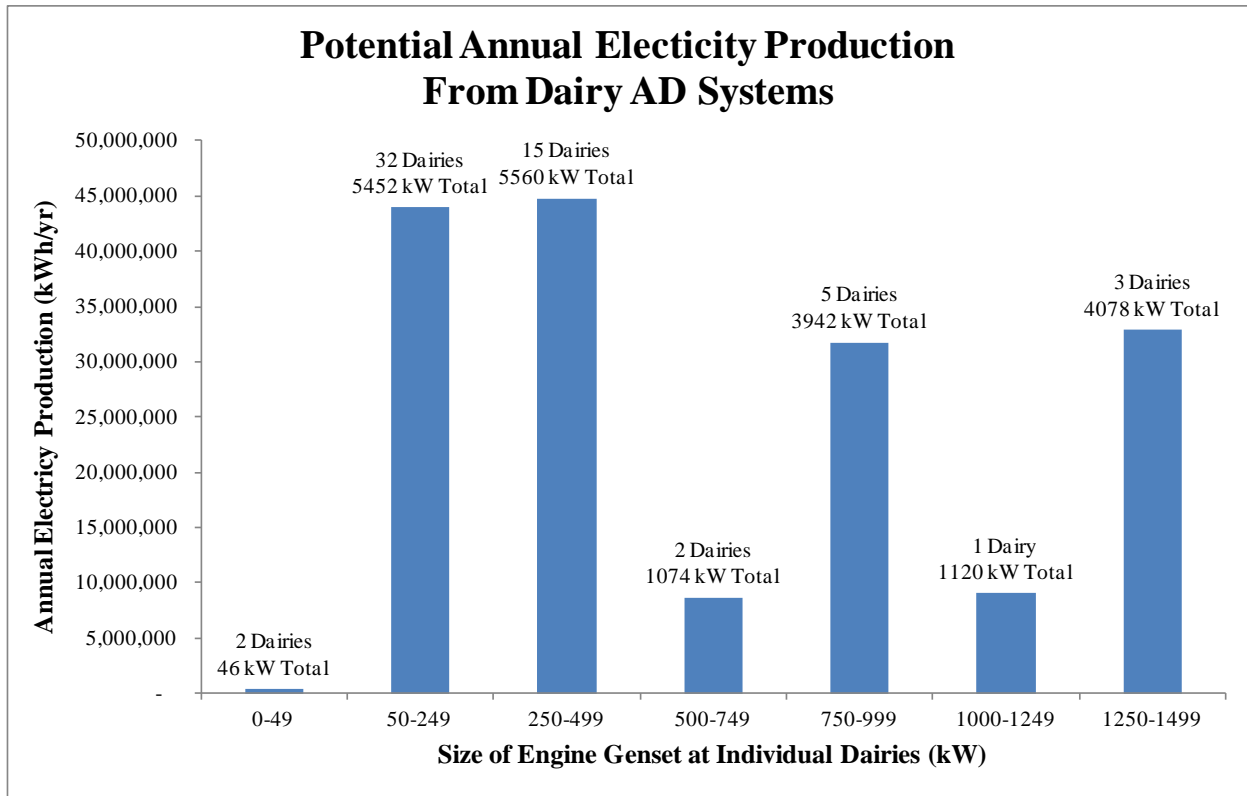

SECTION 4 – ENVIRONMENTAL AND REGULATORY

The State of Washington has a well developed and straight forward permit program that specifically addresses anaerobic digester development. The following paragraphs briefly describe the various permit programs.⁷

WA Solid Waste Permitting

AD systems that contain at least 50 percent manure and no more than 30 percent other organic waste may operate under an exemption from solid waste handling permits. Systems not subject to the exemptions must obtain a solid waste handling permit.

WA Water Permitting

AD systems operating at permitted CAFOs do not need an additional permit if the system is digesting only manure.

Water quality permits are required for discharges to surface and ground water (RCW 90.48.160). Operators, including digesters and participating dairies, must manage their operations to ensure that they do not discharge to surface or ground water. When discharge is unavoidable, water quality permits are required prior to any discharge.

Anaerobic digesters located on licensed dairies need to be covered under the dairy's nutrient management plan (Chapter 90.64 RCW). The Dairy Nutrient Management Act ("NMA") requires all licensed dairies to develop, update, and implement NMP's, register with WSDA, allow regular inspections, and keep records verifying that the NMP is being followed. These records can also show that discharges are not occurring, thus avoiding the need for water quality permits.

WA Air Permitting

New or modified sources of air pollution in the state of Washington require an air permit prior to beginning construction and operation (Clean Air Act, Chapter 70.94 RCW; New Source Review WAC 173-400-110). Air permits (Notice of Construction or Orders of Approval) regulate criteria pollutants such as particulate matter, sulfur dioxide, and nitrogen oxides, and also toxic air pollutants such as ammonia and hydrogen sulfide

Local Jurisdiction Permitting

Local or county planning agency requirements for the planned anaerobic digesters must be satisfied. Requirements may include permit approvals for building, grading, water systems, shorelines, right-of-way, utilities, site plans, septic systems, floodplains, zoning, and others.

The State Environmental Policy Act (SEPA) may require review of the environmental impacts of the planned digester by a local or state agency (Chapter 43.21C RCW). State policy requires state and local agencies to consider the likely environmental consequences of the decisions they make, including decisions to approve or deny license applications or permit proposals.

⁷ Washington State University Fact Sheet FS040E

REC Qualification

With the passage of Initiative 937 in 2006 the State of Washington passed a renewable energy standard that applies to PacifiCorp. The Renewable Portfolio Standard calls for electric utilities that serve more than 25,000 customers to obtain 15 percent of their power from renewable sources by the year 2020. Between January 1, 2012 through December 31, 2015 at least 3 percent of PacifiCorp's load must be supplied by renewable sources. For the period January 1, 2016 through December 31, 2019 the percentage increases to 9 percent. The increase to 15 percent must be met by January 1, 2020. For purposes of the standard anaerobic digesters qualify as renewable sources. Energy from renewable sources is eligible for compliance if the facility began operations after March 31, 1999. The facility must be located in the Pacific Northwest as defined by the Bonneville Power Administration.

All of the generation that could be produced from AD projects with dairies in the Yakima County service territory would generate REC's that could be registered and traded. The Western Renewable Energy Generation Information System ("WREGIS") is an independent renewable energy tracking system for the region covered by the Western Electricity Coordinating Council ("WECC"). REC's can be registered with WREGIS and traded within the WECC states. It is beyond the scope of this assessment to establish the market value of REC's traded within the region.

Other Investment Incentives***Investment Tax Credit***

The federal business energy investment tax credit is available for CHP projects. The credit is equal to 10 percent of expenditures, with no maximum limit stated. Eligible CHP property generally includes systems up to 50 MW in capacity that exceeds 60 percent energy efficiency, subject to certain limitations and reductions for large systems. The efficiency requirement does not apply to CHP systems that use biomass for at least 90 percent of the system's energy source, but the credit may be reduced for less-efficient systems. This credit applies to eligible property placed in service after October 3, 2008.

Production Tax Credit

The federal electricity production tax credit has expired and is no longer available.

Washington Renewable Energy Cost Recovery Incentive Payment Program

In May 2005, Washington enacted Senate Bill 5101, establishing production incentives for individuals, businesses, and local governments that generate electricity from solar power, wind power or anaerobic digesters. The incentive amount paid to the producer starts at a base rate of \$0.15 per kilowatt-hour ("kWh") and is adjusted by multiplying the incentive by the following factors:

- For electricity produced using solar modules manufactured in Washington State: 2.4.
- For electricity produced using a solar or wind generator equipped with an inverter manufactured in Washington State: 1.2.
- For electricity produced using an anaerobic digester, by other solar equipment, or using a wind generator equipped with blades manufactured in Washington State: 1.0.

- For all other electricity produced by wind: 0.8.

These multipliers result in production incentives ranging from \$0.12 to \$0.54/kWh, capped at \$5,000 per year. Ownership of the renewable-energy credits (“RECs”) associated with generation remains with the customer-generator and does not transfer to the state or utility.

Washington Energy Sales and Use Tax Exemption

In Washington State, there is a 75 percent exemption from tax for the sales of equipment used to generate electricity using fuel cells, wind, sun, biomass energy, tidal or wave energy, geothermal, anaerobic digestion or landfill gas. The tax exemption applies to labor and services related to the installation of the equipment, as well as to the sale of equipment and machinery. Eligible systems are those with a generating capacity of at least 1 kilowatt (kW). Purchasers of the systems listed above may claim an exemption in the form of a remittance. Originally scheduled to expire on June 30, 2013, the exemption has been extended through January 1, 2020.

Greenhouse Gas Reduction

According to the USEPA, methane is a greenhouse gas that is approximately 21 times more effective in trapping heat in the atmosphere than carbon dioxide over a 100-year period. Anthropogenic sources of methane include landfills, natural gas and petroleum systems, agricultural activities, coal mining, stationary and mobile combustion, wastewater treatment, and certain industrial processes. Methane emissions generated by the manure management practices of large dairy operations have been identified as a significant source of GHGs. The US EPA is required to regulate GHG emissions under the broad provisions and authorities of the Clean Air Act. Therefore, reducing GHG emissions has become important and a potential source of revenue on some dairies. Anaerobic digesters can provide a means for dairy farms to participate in markets for GHG avoidance and sequestration.

Anaerobic digestion is a waste stabilization process. Stabilization occurs by the microbially mediated decomposition of the carbon in complex organic compounds to methane and carbon dioxide. This natural process takes place in the manure storage lagoons that exist at most large dairies and results in the generation of biogas, which is made up of approximately 2/3 methane and 1/3 carbon dioxide. Because this process takes place in controlled conditions in an engineered AD system, such a system provides the opportunity to capture and combust the biogas it produces. It is the capture and combustion of this biogas, along with the ability to maximize the degree of waste stabilization that differentiates anaerobic digestion in an AD system from anaerobic decomposition, which occurs naturally in lagoons and other livestock manure storage structures.

The total amount of GHG credits produced from an AD system can be calculated using a protocol published by the Climate Action Reserve and accepted by programs that value and trade the credits. The protocol calculates the net GHG emissions reductions from digestion, subtracting post-digester installation GHG emissions to those that would be emitted without digestion. In order to sell credits, a project must have these reductions certified by a third party registry. According to the Climate Trust, a third party that certifies such credits, a typical project in the Pacific Northwest that incorporates an on-farm AD system will generate 2.5 to 3.5 credits

per mature cow equivalent each year.⁸ Using the average of the two values and the range of animals described in Section 3, if all of the dairies that could produce more than 500 kW developed AD systems, they would avoid 164,000 to 230,000 tonnes of CO₂e emissions per year.

⁸ Weisberg, Peter. Environmental Market Revenue Opportunities for Biogas Projects. NEBC NW Biogas Workshop, Portland, OR, April 27, 2012.

SECTION 5 – DEVELOPMENT COST

Completed Major Equipment Revisions

The capital requirements to install a digester will vary widely depending on digester design chosen, size, and choice of equipment for utilization of the biogas. In 2009 the US EPA AgSTAR program analyzed the investment at 19 dairy projects that installed plug flow digester similar the digesters in use in Washington. The analysis of investments made versus herd size at 19 dairy farm plug-flow digesters yielded an estimate of \$566,006 + \$617 per cow in 2009 dollars. The estimates provided in this assessment have been normalized to 2014 dollars using an inflation rate of 1.5 percent per year. Ancillary items that may be incurred are charges for connecting to the utility grid and equipment to remove hydrogen sulfide, which could add up to 20 percent to the base amount. There is considerable interest in digester designs that are economically feasible for smaller farms, but some digester components are difficult to scale down. A complete mix digester with separator installed on a 160-cow Minnesota dairy farm in 2008 cost \$460,000, or \$2,875/cow. Another way to consider the investment is to assume a unit cost per kilowatt of installed capacity to be \$3000 to \$3500. Smaller farms would not likely invest the capital to install digesters for power production. Figure 5-1 below shows the total value of the potential capital investment if all of the farms in a given generation capacity were developed based on the AgStar estimated cost. Figure 5-2 shows the individual farm investment based on the generation capacity. The total capital investment estimate that would be required to develop 100 percent of the resources would be approximately \$91MM. It is not practical to assume that all projects rise to the level of investment quality. May of the smaller farms would not be practical. We have included the capital investment shown for each generator capacity in Figure 5-2.

Figure 5-1: Total Capital Investment

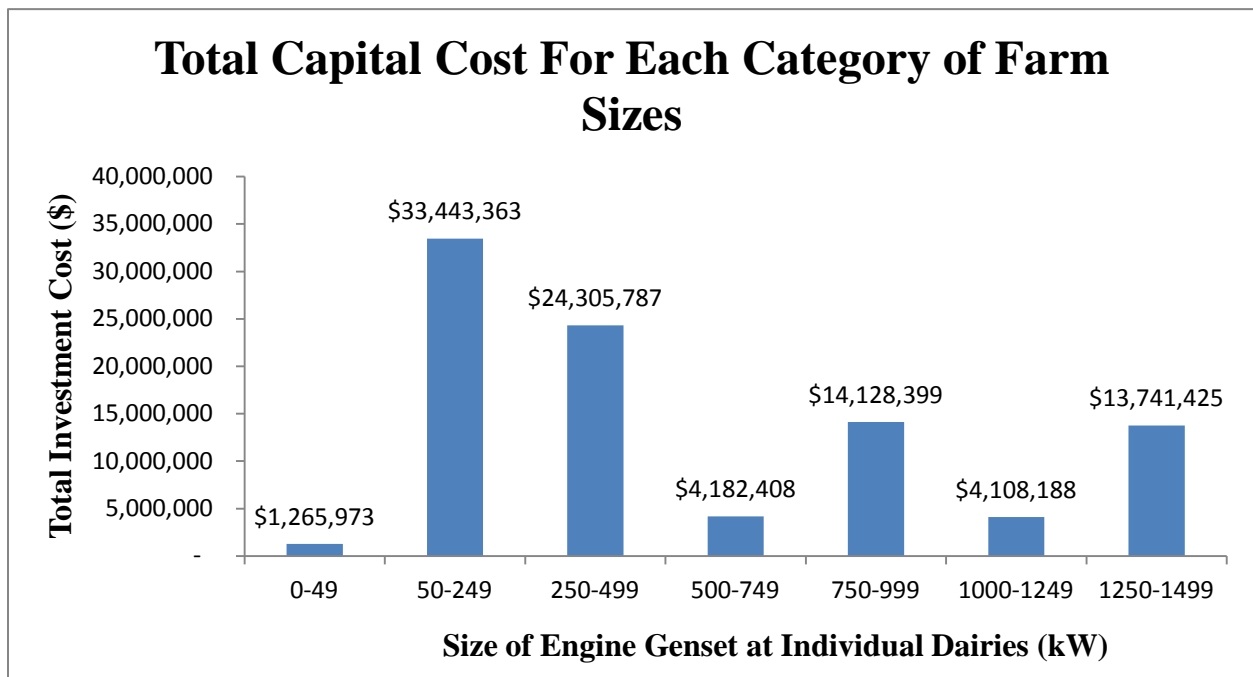
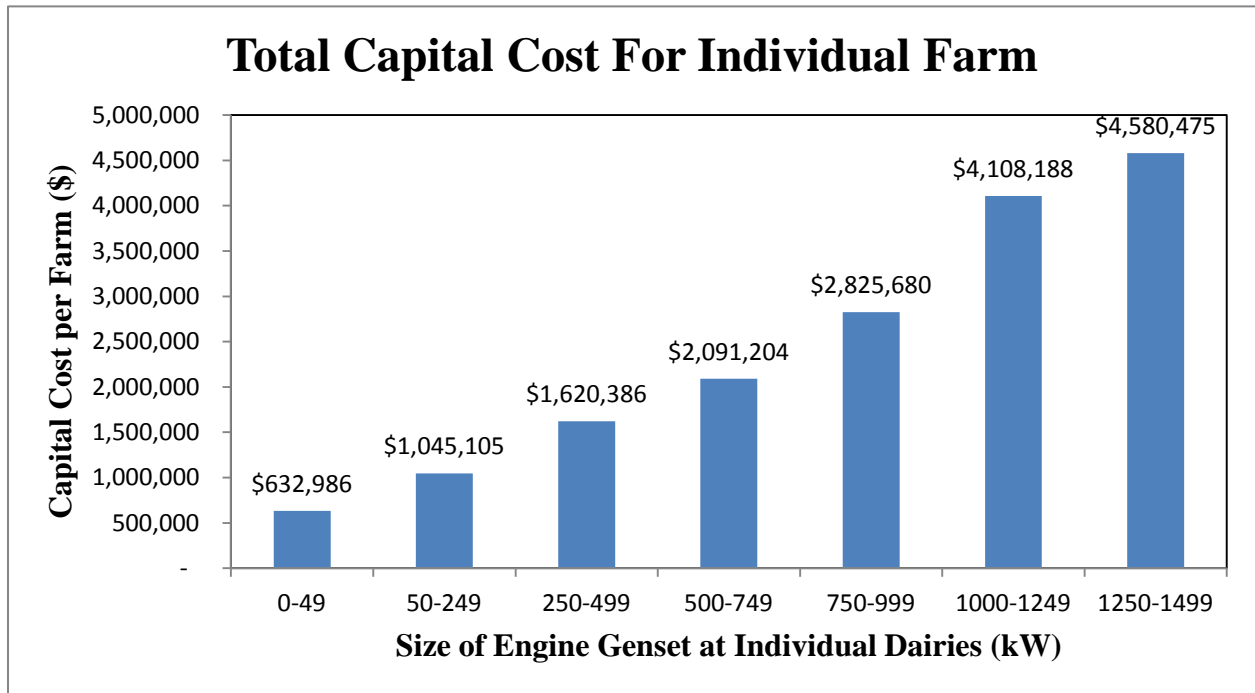

Figure 5-2: Total Investment on an Individual Farm at Various Generation Capacities

SECTION 6 – OPERATING COSTS

The USDA Natural Resources Conservation Service has been heavily involved in developing the federal design and operation standards for the design and installation of farm based digesters. Much of the work and information published by the AgStar program referenced NRCS Practice Standards. The following operating cost information is based on an analysis done by the NRCS.⁹

Table 6-1: USDA NRCS Operating Cost Analysis

Electricity production costs for AD case studies with reported biogas production					
Manure AD system type by species	\$/GJ	\$ per kWh	No. of systems	\$/GJ O&M	\$ per 1000 kWh O&M
Mixed—Swine	20.11	0.07	2	0.80	2.90
AD covered anaerobic lagoon—Swine	25.62	0.09	5	2.09	7.57
Plug flow—Dairy	25.78	0.09	9	2.69	9.74
Electricity	25.88			–	–
AD—Other swine	27.16	0.10	1	1.61	5.82
Mixed—Dairy	52.39	0.19	4	3.54	12.79
AD—Other dairy	79.33	0.29	1	12.07	43.64

* Average U.S. retail costs taken from DOE

* A thermal efficiency of 30 percent was assumed for biogas to electrical energy conversion.

Based on the data from the NRCS analysis and keeping with the plug flow digester design it is shown that the operating costs with electrical production are \$0.09/kWh. The cost analysis is based on the operating results of nine different projects. It is not reported in the discussion how large the systems are or what the basis of the fixed and variable expenses are. It should be expected that fixed operating costs would be lower based on economies of scale for larger digester projects.

Addition of Other Organic Wastes

It has been accepted in the dairy based digester industry that using the electrical power internally and offsetting retail electricity rates with the generator output can yield better economic performance than the sale of power at wholesale rates. Including the various incentives does not normally lead to profitable commercial operations generally. The use of additional organic can boost the gas production by as much as 300 percent with very minimal increases in capital and operating costs. This would have a direct impact on the performance of the system and lower the O&M costs accordingly. Unfortunately the proximity to significant quantities of those additives is limited due to the location in Yakima County.

⁹ “An Analysis of Energy Production Costs from Anaerobic Digestion systems on US Livestock Production Facilities” USDA NRCS, October 2007

George DeRuyter & Sons Dairy

The George DeRuyter Dairy is located within the Yakima County service territory. It is the only dairy in the service territory to have installed a commercial digester and an excellent example of the implementation of the technology and profitability challenges associated with electrical sales as the only source of cash flow. Appendix 1 to this report includes a feasibility report prepared for the Washington State Department of Commerce outlining the economic and environmental challenges facing the development of AD projects in the state.¹⁰

The report provides an analysis of the development challenges and profitability of a dairy based digester in the Yakima Valley. The report is significant due to the fact that it is based on one of the largest dairies in the State of Washington where economies of scale can have a positive impact on the development cost and output. The report also has analysis of the cash flow impacts of utilizing electrical sales based on the Washington State Schedule 37 avoided cost rates for Qualifying Facilities as the only source of income. The lack of success in developing projects in the service territory is characterized as follows.

- ❑ Projects based entirely on revenue streams from Power Purchase Agreements at the Qualifying Facility rate structure are not likely to have commercial success. This is a situation that is a factor elsewhere throughout the U.S with Pacific Northwest electrical prices only exacerbating the problem for the region, especially in the Yakima River Basin, which has some of the lowest rates in the nation.
- ❑ Presence of the dairies in an area away from urban centers which negatively impacts a project's ability to secure off-farm co-digestion substrates with or without tipping fees. In the northwest area of the state projects are more likely able to source additional substrates and organic wastes that contribute to gas production and revenue from both energy sales and tipping fees
- ❑ Declining Renewable Energy Credits (RECs) for electrical power production has reduced the value of these credits, especially in the Pacific Northwest, where a multitude of wind projects and reduced demand have flooded the renewable power market.
- ❑ Success rates for development projects could be improved with a move toward Renewable Natural Gas sales rather than dependence on revenue from electricity sales.

¹⁰ "An Anaerobic Digester Case Study Alternative Offtake Markets and Remediation of Nutrient Loading Concerns Within the Region" Washington State Department of Commerce

APPENDIX Q – ENERGY STORAGE SCREENING STUDY

HDR Engineering (HDR) was retained by PacifiCorp Energy (PacifiCorp) to perform an Energy Storage Study to support PacifiCorp’s 2013 Integrated Resource Plan (IRP) intended to evaluate a portfolio of generating resources and energy storage options. This report has been updated for the 2015 IRP. The scope of this Energy Storage Study is to develop a current catalog of commercially available utility-scale and distributed scale energy storage technologies, and to define their applications, performance characteristics, and estimated capital and operating costs. The information presented in this report has been gathered from public and private documentation, studies, reports, and project data of energy storage systems and technologies.

Update to
Energy Storage Screening Study
For Integrating Variable Energy
Resources within the PacifiCorp System

July 9, 2014

Prepared for:
PacifiCorp Energy
Salt Lake City, Utah

Prepared by:
HDR Engineering, Inc.

Table of Contents

1	Executive Summary	5
2	Introduction	9
2.1	Integrating Variable Energy Resources	9
3	Energy Storage Systems and Technology	11
3.1	Pumped Storage	11
3.1.1	<i>Single-Speed versus Variable-Speed Technology</i>	13
3.1.2	<i>Open-Loop and Closed-Loop Systems</i>	14
3.1.3	<i>Potential Projects in PacifiCorp Service Area</i>	15
3.1.4	<i>Operating Characteristics</i>	26
3.1.5	<i>Regulatory Overview</i>	26
3.1.6	<i>Capital, Operating, and Maintenance Cost Data</i>	27
3.2	Batteries	30
3.2.1	<i>Battery Energy Storage Technology Description</i>	30
3.2.2	<i>Manufacturers and Commercial Maturity of Technology</i>	30
3.2.3	<i>Summary of Project Data</i>	39
3.2.4	<i>Performance Characteristics</i>	40
3.2.5	<i>System Details and Requirements</i>	43
3.2.6	<i>Technology Risks</i>	44
3.2.7	<i>Capital, Operating and Maintenance Cost Data</i>	44
3.3	Compressed Air Energy Storage	45
3.3.1	<i>CAES Technology Description</i>	45
3.3.2	<i>Performance Characteristics</i>	48
3.3.3	<i>Geological Considerations</i>	49
3.3.4	<i>Capital, Operating, and Maintenance Cost Data</i>	50
3.4	Flywheels	52
3.4.1	<i>Flywheel Technology Description</i>	52
3.4.2	<i>Manufacturers</i>	52
3.4.3	<i>Performance Characteristics</i>	53
3.4.4	<i>Manufacturer Pros and Cons</i>	54
3.4.5	<i>Capital, Operating and Maintenance Cost Data</i>	54
3.5	Liquid Air Energy Storage (LAES)	54
3.5.1	<i>LAES Technology Description</i>	54
3.5.2	<i>LAES Performance</i>	54

3.6	Supercapacitors	55
3.6.1	Supercapacitor Technology Description.....	55
3.6.2	Supercapacitor Performance	55
3.7	Superconducting Magnet Energy Storage (SMES).....	55
3.7.1	SMES Technology Description	55
3.7.2	SMES Performance	56
4	Comparison of Storage Technologies	57
4.1	Technology Development	57
4.2	Applications	58
4.3	Space Requirements	58
4.4	Performance Characteristics	59
4.5	Project Timeline.....	61
4.6	Cost	61
5	Conclusions.....	63

Appendices

APPENDIX A – ENERGY STORAGE MATRIX

APPENDIX B – PUMPED STORAGE DATA

B.1 – Klickitat Response – JD Pool

B.2 – EDF Response – Swan Lake North

B.3 – Swan Lake North Plan Drawing

B.4 – Swan Lake North Profile Drawing

B.5 – Gridflex Response – Black Canyon

B.6 – Conceptual Pumped Storage Development Schedule

B.7 – AACE Cost Estimating Guidelines

APPENDIX C – BATTERY STORAGE DATA

APPENDIX D – COMPRESSED AIR ENERGY STORAGE DATA

APPENDIX E – OTHER STORAGE TECHNOLOGY DATA

Table of Figures

Figure 1 - Existing Pumped Storage Projects in the United States.....	11
Figure 2 - Typical Pumped Storage Plant/System	12
Figure 3 - Preliminary Proposed Pumped Storage Projects as of April, 2014 (HDR).....	15
Figure 4 - Swan Lake North Site Layout and Profile (Swan Lake North Pre-Application Document).....	20
Figure 5 - JD Pool Project Layout (JD Pool Preliminary License Application).....	22
Figure 6 - Black Canyon Layout (Black Canyon Preliminary Permit Application)	24
Figure 7 - A123 Li-ion Cells.....	31
Figure 8 - Renewable Integration Deployment in West Virginia	32
Figure 9 - NAS Cell Module.....	33
Figure 10 - NGK NAS 8 MW (Japan).....	33
Figure 11 - VRB Cell Stack and Electrolyte Tanks.....	34
Figure 12 - Standard VRB Plant Design 3 MW	34
Figure 13 - PowerCell™ Stacks with PCS	35
Figure 14 - DPR15-100C Container.....	36
Figure 15 - ZnBr Cell Stacks	37
Figure 16 - Premium’s TransFlow2000 Section (ZnBr battery)	37
Figure 17 - 3 MW of frequency regulation at the PJM Interconnection.....	38
Figure 18 - UberBattery Energy Block.....	38
Figure 19 - Rated MW Capacity of US Battery Energy Storage Projects.....	39
Figure 20 - Rated MWh Capacity of US Battery Energy Storage Projects	40
Figure 21 - Typical Battery Life Cycle Curve State of Charge (SOC)	42
Figure 22 - CAES Geological Formations	50
Figure 23 - Potential Geological Formations Favorable for CAES.....	50
Figure 24 - Flywheel Plant Stephentown, New York	53
Figure 25 - Current Worldwide Installed Energy Storage Facility Capacity (Source: CESA).....	58
Figure 26 - Li-ion Battery Field and a Hydroelectric P/S Plant for 20,000 MWh of Storage (Source: HDR).....	59
Figure 27 - Current Energy Storage Technology Capabilities in Real Time (Source: HDR).....	60
Figure 28 - Current Energy Storage Technology Capabilities (Log-Log Scale) (Source: Electricity Storage Association).....	61
Figure 29 - Operation and Maintenance Costs for Energy Storage Technologies.....	63

Table of Tables

Table 1 - Summary of Highlighted Pumped Storage Projects	5
Table 2 - Energy Storage Technology Summary Table	8
Table 3 - Example Comparison of Primary Characteristics.....	14
Table 4 - Summary of Highlighted Pumped Storage Projects as Provided by the Project Developers	16
Table 5 - Comparison of Cost Opinions.....	28
Table 6 - CAES Typical Project Schedule	51
Table 7 - Energy Storage Comparison Summary.....	57
Table 8 - Space Required for 20,000 MWh of Energy Storage.....	59
Table 9 - Summary of Cost and Capacity Data	62

Legal Notice to Third Parties

This report was prepared for PacifiCorp Energy by HDR Engineering Inc. (HDR) and is based on information not within the control of HDR. HDR has assumed that the information provided by others, both verbal and written, is complete and correct. While it is believed that the information, data, and opinions contained herein will be reliable under the conditions and subject to the limitations set forth herein, HDR does not guarantee the accuracy thereof. Use of this report or any information contained therein by any party other than PacifiCorp Energy or its affiliates, shall constitute a waiver and release by such third party of HDR from and against all claims and liability, including, but not limited to, liability for special, incidental, indirect, or consequential damages in connection with such use. In addition, use of this report or any information contained herein by any party other than PacifiCorp Energy or its affiliates, shall constitute agreement by such third party to defend and indemnify HDR from and against any claims and liability, including, but not limited to, liability for special, incidental, indirect, or consequential damages in connection with such use. To the fullest extent permitted by law, such waiver and release and indemnification shall apply notwithstanding the negligence, strict liability, fault, breach of warranty, or breach of contract of HDR. The benefit of such releases, waivers, or limitations of liability shall extend to the related companies and subcontractors of any tier of HDR, and the directors, officers, partners, employees, and agents of all released or indemnified parties.

1 EXECUTIVE SUMMARY

HDR Engineering (HDR) was retained by PacifiCorp Energy (PacifiCorp) to perform an Energy Storage Study to support PacifiCorp's 2013 Integrated Resource Plan (IRP) intended to evaluate a portfolio of generating resources and energy storage options. This report has been updated for the 2015 IRP. The scope of this Energy Storage Study is to develop a current catalog of commercially available utility-scale and distributed scale energy storage technologies, and to define their applications, performance characteristics, and estimated capital and operating costs. The information presented in this report has been gathered from public and private documentation, studies, reports, and project data of energy storage systems and technologies.

HDR has reviewed and investigated the following energy storage technologies for this study:

- Pumped Storage Hydroelectric
- Battery Energy Storage Systems
- Compressed Air Energy Storage

In addition, some less-than-utility-scale or emerging technologies are described without detailed discussion of cost or performance characteristics.

Pumped storage hydroelectric facilities are classified as a mass energy storage technology capable of providing thousands of megawatt hours (MWh) of dispatchable energy. Pumped storage is ideal for large grid applications such as load shifting, peak shaving, spinning reserve, and intra-second grid needs such as frequency regulation, all on a large scale (200 to 1,000+ MW). Due to the grid scale size of the projects interconnection of these facilities typically requires availability of Extra High Voltage (EHV) transmission lines. Furthermore, pumped storage facilities also require site-specific attributes and resources, such as water rights and elevated reservoir.

There are currently forty (40) pumped storage hydroelectric projects operating in the United States. In addition, there are currently over sixty (60) projects being considered for development under the Federal Energy Regulatory Commission (FERC) licensing process. Three projects within PacifiCorp's territory have been reviewed for this IRP update report: the JD Pool Pumped Storage Project, the Swan Lake North Pumped Storage Project, and the Black Canyon Pumped Storage Project. These proposed sites were selected based on existing project features located within the PacifiCorp balancing area, environmental impacts that are fairly well understood, and the current status of project development and licensing. Project parameters are summarized in Table 1 below.

Table 1 - Summary of Highlighted Pumped Storage Projects

Item	Swan Lake North	JD Pool	Black Canyon
Location	Oregon	Washington	Wyoming
Approximate Static Head (ft)	1,300	2,400	1,063
Energy storage (MWh)	5,280	16,500	5,550
Assumed Hours of Storage (hrs)	8.8	11	9.5

Item	Swan Lake North	JD Pool	Black Canyon
Estimated Installed Capacity (MW)	600	1,500	600
Developer Provided Estimated Capital Cost (\$/kW) (See section 3.1.6 for details of HDR's Opinion of Costs)	\$2,300	\$1,700-\$2,500	\$1,500
Estimated Year 1 O&M Cost (estimated as a function of capacity and annual energy. See section 3.1.6 for details)	\$9.4 million	\$19.1 million	\$9.4 million
Water-to-wire efficiency	75-82%	75-82%	75-82%

Battery storage is gaining acceptance in small-scale (~ 20 MW) storage applications, particularly in conjunction with renewable resources. Battery energy storage systems are considered to be a small scale energy storage option focused on applications such as energy regulation, frequency response, load following and ramping support, energy arbitrage, and even distribution system upgrade deferral. In the case of renewable integration, batteries primarily function to dampen the effects of generation and load differences resulting from the variability in renewable energy generation profiles. Battery technologies and their respective manufacturers reviewed for this study, including project characteristics, include the following:

- Lithium ion (Li-ion) – A123 Systems: Since 2009, seven projects have been installed in the US with capacity of 69 MW / 47.5 MWh. Largest projects include 20 MW / 5 MWh in Johnson City, NY and 8 MW / 32 MWh in Tehachapi, CA. Currently under development is a 32 MW / 8MWh system in Oro Mountain, WV.
- Sodium sulfur (NAS) – NGK Insulators, Ltd.: The first project was 0.5 MW for a TEPCO Kawasaki substation in 1995. Installations now include over 120 international projects with capacity of 190 MW and 1,300 MWh. The largest project is 12 MW / 86.4 MWh at a Honda facility Japan, installed in 2008. As of 2010, six projects in the US with 14.75 MW / 73.2 MWh have been installed, with the largest project being 4 MW / 24 MWh in Presidio, TX (2010). Five projects totaling 7.9 MW / 23.2 MWh are planned throughout the US.
- Vanadium Redox (VRB) – Prudent Energy: The first US project was with PacifiCorp in Castle Valley, UT with 0.250 MW / 2 MWh installed in 2004. In 2009, a 0.6 MW / 3.6 MWh system was installed at Gills Onion plant, CA. Two other projects are in development in CA, with combined nameplate capacity of 2.2 MW.
- Dry Cell – Xtreme Power, Inc.: The first installation of 0.5 MW / 0.1 MWh was a test facility in Antarctica for microgrid peak shaving completed in 2006. A 1.5 MW / 1 MWh test facility was installed in Maui, HI for renewable integration in 2009.
- Zinc Bromide (ZnBr) – Premium Power: To date, 6.9 MW / 17.2 MWh has been installed in the US. Five recent projects, two in CA and three in MA, have been installed or are under development, rated at 0.5 MW / 3 MWh each.

- Advanced Lead Acid (Pb-Acid) – Ecoult has installed a 3 MW scale demonstration facility, as well as a 3 MW frequency regulation facility on the PJM grid in Pennsylvania. Also installed has been a 3 MW micro-grid application that allows an island of 1,500 people to utilize 100% renewable energy.

Compressed Air Energy Storage (CAES) is also classified as mass energy storage, although on a capacity scale (~100 MW) between batteries and pumped storage. A typical CAES plant would consist of a series of motor driven compressors capable of filling a storage cavern with air during off-peak, low-load hours. At high-load, on-peak hours, the stored compressed air is delivered to a series of combustion turbines which are fired with natural gas for power generation. Utilizing pre-compressed air removes the need for a compressor on the combustion turbine, allowing the turbine to operate at high output and efficiency during peak load periods. Compressed air energy storage is the least implemented and developed of stored energy technologies evaluated herein. Only two plants are in operation, including Alabama Electric Cooperative's (AEC) McIntosh plant which began operation in 1991. Others projects have been proposed, but have not progressed beyond concept.

Other emerging energy storage technologies have been briefly reviewed for this report, including flywheels, liquid air energy storage, super-capacitors, and superconducting magnets. Although all of these technologies can be connected to the grid, they are still considered developmental and small scale. Generally, these other technologies could only be used for short durations (seconds to minutes), for supplying backup power in an outage event, or to help regulate voltage and frequency.

HDR has performed an initial comparison of the three primary energy storage technologies, including pumped storage, batteries and compressed air. Table 2 summarizes the comparison of key criteria for these technologies including project capital cost as evaluated by HDR in 2014 dollars. More detailed comparisons are included in Appendix A. HDR has also reviewed and commented upon the overall commercial development of these technologies, the applications which each technology is suited to, along with space requirements, performance characteristics, project timelines, and the Developer provided capital, operating and maintenance (O&M) costs.

There are challenges associated with comparing costs for these different types of energy storage technologies. Initial capital cost is one indicator; however long-term annual O&M cost provides another factor for comprehensive economics and determining financial feasibility. Operating and maintenance costs associated with various battery technologies can be high compared to pumped storage, but this cost varies depending upon the technology. As battery technology develops further, and grid scale installations continue, a better understanding of the costs associated with operation and maintenance will be achieved. Conversely, while the capital costs for pumped storage are high when looked at in total, they are competitive with batteries on a dollar/kW installed basis, and have low fixed and variable O&M costs.

Table 2 - Energy Storage Technology Summary Table

	Pumped Storage Hydro (Three sites)	Batteries	Compressed Air Energy Storage
Range of power capacity (MW)	600 – 1,500	1-32	100+
Range of energy capacity (MWh)	5,550 – 16,000	Variable depending on Depth Of Discharge	800+
Range of capital cost (2014\$ per kW)	\$1,700 - \$2,500	\$800 - \$4,000	\$2,000 - \$2,300
Year of first installation	1929	1995 (sodium sulfur)	1978

2 INTRODUCTION

PacifiCorp, as well as other utilities and power authorities throughout the world, face a major challenge in balancing increasing levels of variable energy resources. As generation from variable energy resources and their relative percentage of load grow, there is an increasing need for additional system flexibility to assure grid reliability. Based on both industry and HDR studies, it is evident that expanded transmission interconnections, continued modernization of the existing power plants, market changes that encourage greater operational flexibility of existing generation assets and new energy storage facilities will be required across the United States over the next decade.

The 2015 PacifiCorp Integrated Resource Plan (IRP) is expected to include a portfolio of generating resources and energy storage options for evaluation. These include both fossil fuel options, such as coal and natural gas, as well as renewable options including wind, geothermal, hydro, biomass, and solar. In order to integrate additional renewable generation into their IRP, it is anticipated that energy storage may be required. For that reason, PacifiCorp has engaged HDR to develop a current catalog of commercially available and emerging energy storage technologies with estimates of performance and costs.

Energy storage permeates our society, manifesting itself in products ranging from small button batteries to large-scale pumped storage hydro-electric projects. Energy storage for utility-scale applications has historically relied upon pumped storage hydro facilities and the large reservoirs associated with conventional hydropower stations. In recent years, utilities have also considered and implemented several pilot projects utilizing various battery technologies. To a limited extent, compressed air energy storage and flywheels have also been implemented. When installed over a large service area, the totality of these distributed systems could provide reserves to the regional grid for limited durations. Within the electric utility industry, there is uncertainty regarding which energy storage system can provide the optimal benefit for a given application. The following discussion is intended to catalog the energy storage technologies available to date, to summarize the current state of development of these energy storage technologies, to provide a high level comparison of these technologies, and provide comments and discussion on their implementation in an effort to assist PacifiCorp with the integration of variable energy resources and energy storage into its IRP.

2.1 Integrating Variable Energy Resources

Variable energy resources provide a sustainable source of energy that uses no fossil fuel and produces zero carbon emissions. One of the constraints of variable generation is that the energy available is non-dispatchable; it tends to vary and is somewhat unpredictable. The power-system load is also variable; power-system reserves are required to match changes in generation and demand on a real-time basis. Variable generation cannot be dispatched specifically when energy is needed to meet load demand. Wind and utility industries have been able to address many of the variability issues through improvements in wind forecasting, diversification of wind turbine sites, improvements in wind turbine technology, and the creation of larger power-system control areas. At low wind penetration levels, wind output typically can be managed in the regulation time-frame by calling upon existing system reserves, curtailing output and/or diversifying the locations of wind farms over a broad geographic area.

As more variable energy is added to the power system, additional reserves are required. Flexible and dispatchable generators, such as hydro, CAES, or batteries, are required to provide system capacity and balancing reserves to balance load in the hour-to-hour and sub-hour time-frame. In addition to system

reserves, every balancing authority has the need for energy storage to balance excess generation at night and shift its use to peak demand hours during the day. Conventional hydropower projects do this by shutting down units and storing energy in the form of elevated water, and it is the most common form of energy storage in the world. As variable energy output and the ratio of wind generation to load grows, historical system responses will need to be modified to take advantage of the benefits of variable energy resources to the regional grid and to assure system reliability.

It should be mentioned that variability is not a new phenomenon in power system operation. Demand has fluctuated since the first consumer was connected to the first power plant. The resulting energy imbalances have always had to be managed, mainly by dispatchable power plants. The evolution of variable energy resources in the system is an additional, rather than a new, challenge that presents two elements: variability (now on the supply-side as well), and uncertainty.

The output from variable energy resource plants fluctuates according to the available resource — the wind, the sun or the tides. These fluctuations are likely to mean that, in order to maintain the balance between demand and supply, other parts of the power system will have to change their output or consumption more rapidly and/or more frequently than currently required. At small penetrations — a few percent in most systems — the additional effort is likely to be slight, because variable energy resource fluctuations will be dwarfed by those already seen on the demand side.

Large variable energy penetration, in contrast, will exacerbate the system variability in extent, frequency and rate of change. As is known by system operators, electricity demand follows a regular pattern. Deducting the contribution of variable energy resources to the grid in correlation to demand is often referred to as the net load. In the review of net load tracking in the Bonneville Power Administration balancing area, no regular pattern is evident with the exception of a tendency for wind to pick up at night and drop off in the morning. This is opposite to electric demand, which highlights the greater variability of net load caused by a 30 percent penetration of variable supply.¹

It is the extent of these ramps, the increases or decreases in the net load, as well as the rate and frequency with which they occur that are of principal relevance to the industry. This is where the balancing challenge lies — in the ability of the system to react quickly enough to accommodate such extensive and rapid changes. Net load ramping is more extreme than demand alone. This is not only because variable energy resource output can ramp up and down extensively over just a few hours, but also because it may do so in a way that is inversely proportional to fluctuations in demand. In contrast, VER output may complement demand — when both increase or decrease at the same time.

So, rather than the question of — how can variable renewables be balanced? — the more pertinent may be: how can increasingly variable net load be balanced? The point is that variability in output (supply) should not be viewed in isolation from variability on the demand-side (load); if the variable energy resource side of the balancing equation is considered separately, a system is likely to be under-endowed with balancing resources.²

¹ Hydroelectric Pumped Storage for Enabling Variable Energy Resources within the Federal Columbia River Power System, Bonneville Power Administration, HDR 2010

² *Harnessing Variable Renewables A Guide to the Balancing Challenge*, 2011
International Energy Agency

3 ENERGY STORAGE SYSTEMS AND TECHNOLOGY

A review of available energy storage technologies was performed for comparative purposes in this study. The results are discussed throughout this report and include the following storage systems:

- Pumped Storage Hydroelectric
- Battery Energy Storage Systems
- Compressed Air Energy Storage

Each of these technologies has been employed for grid scale storage or to provide ancillary services. Many other technologies, such as flywheels, superconducting magnets, and supercapacitors, have been deployed at the distributed-energy scale, and there is significant ongoing research to further develop these technologies and scale them up for bulk energy storage applications. This research is expected to continue for the foreseeable future.

3.1 Pumped Storage

Pumped storage hydroelectric projects have been providing storage capacity and transmission grid ancillary benefits in the U.S. and Europe since the 1920s. Today, there are 40 pumped storage projects operating in the U.S. that provide more than 20 GW, or nearly 2 percent, of the capacity for our nation's energy supply system (Energy Information Admin, 2007). Figure 1 below indicates the distribution of existing pumped storage projects in the U.S. Pumped storage and conventional hydroelectric plants combined account for approximately 77 percent of the nation's renewable energy capacity, with pumped storage alone accounting for an estimated 16 percent of U.S. renewable capacity (Energy Information Admin., 2007).

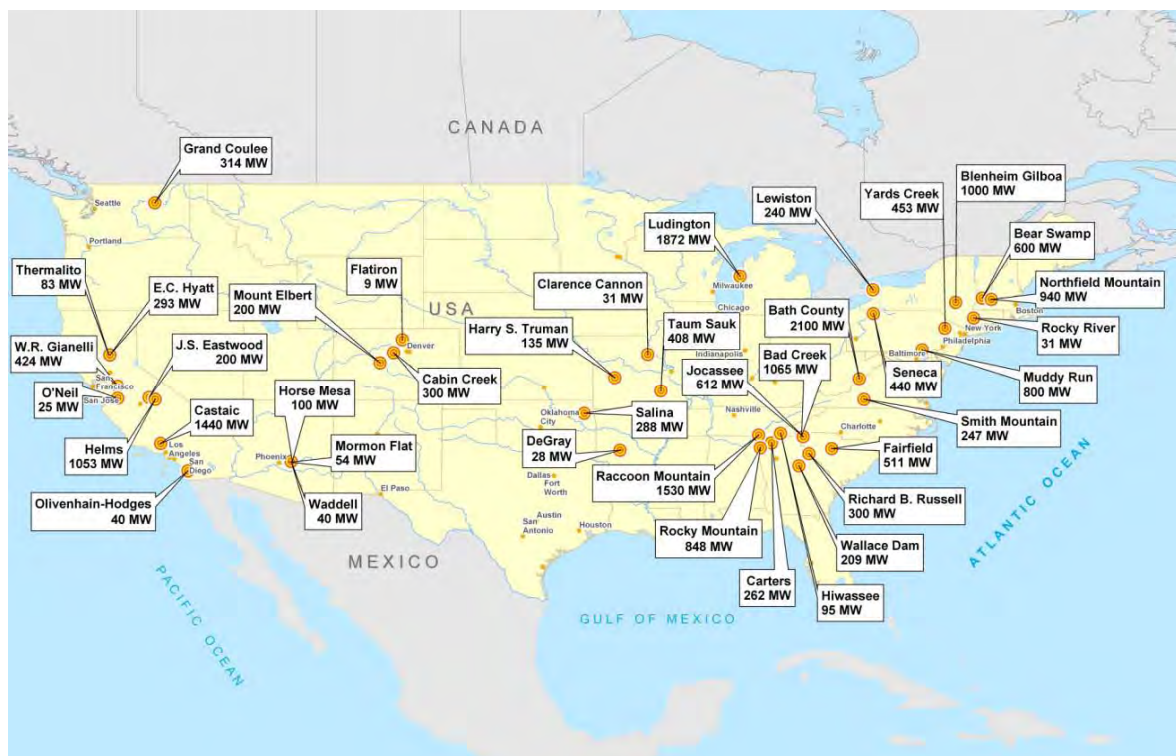

Figure 1 - Existing Pumped Storage Projects in the United States

Pumped storage facilities store potential energy in the form of water in an upper reservoir, pumped from another reservoir at a lower elevation (Figure 2). Historically, pumped storage projects were operated in a manner that, during periods of high electricity demand, electricity is generated by releasing the stored water through pump-turbines in the same manner as a conventional hydro station. In periods of low energy demand or low cost, usually during the night or weekends, energy is used to reverse the flow and pump the water back up hill into the upper reservoir. Reversible pump-turbine/generator-motor assemblies can act as both pumps and turbines. Pumped storage stations are unlike traditional hydro stations in that they are actually a net consumer of electricity, due to hydraulic and electrical losses incurred in the cycle of pumping back from a lower reservoir to the upper reservoir. However, these plants have often proved very beneficial economically due to peak to off-peak energy price differentials, and as well as providing ancillary services to support the overall electric grid.

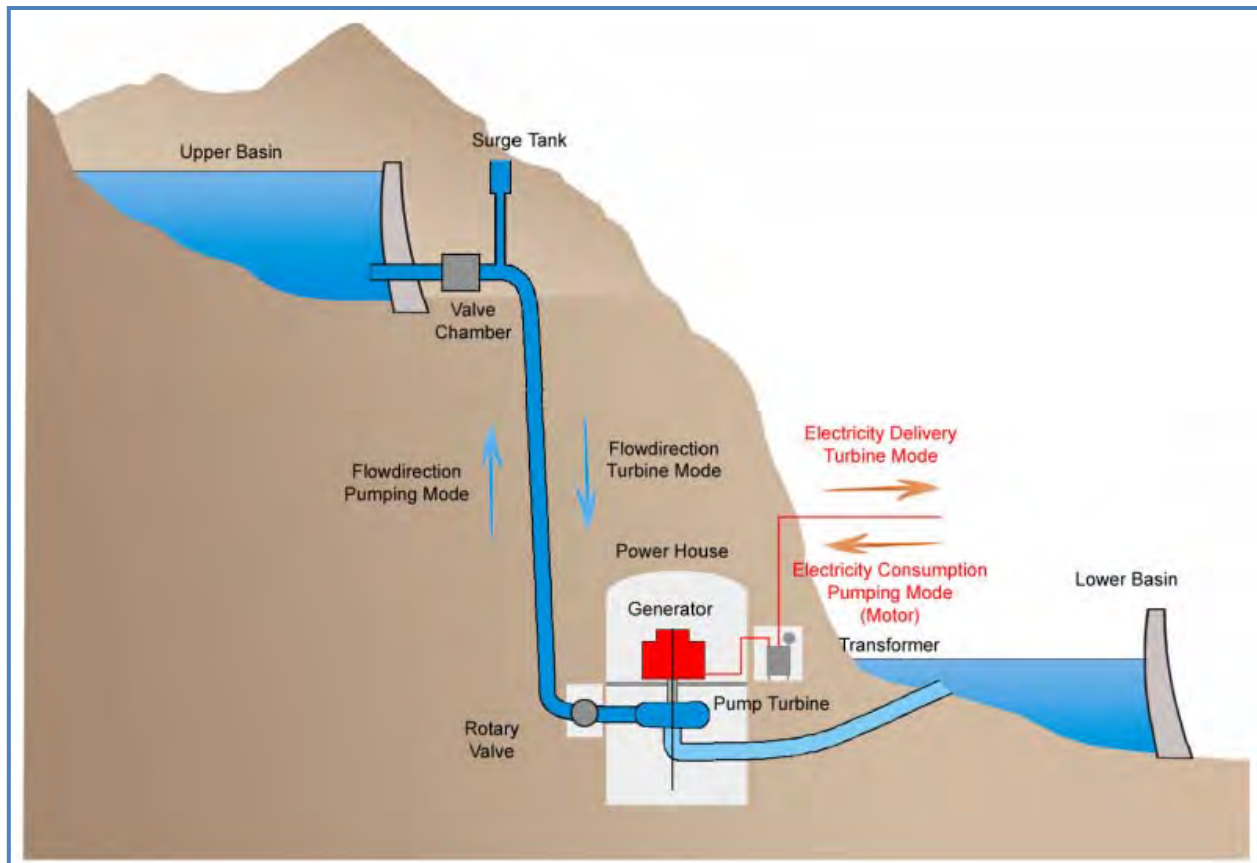

Figure 2 - Typical Pumped Storage Plant/System

The contributions of pumped storage hydro to our nation's transmission grid are considerable, including providing stability services, energy-balancing, and storage capacity. Pumped storage stations also provide ancillary electrical grid services such as network frequency control and reserves. This is due to the ability of pumped storage plants, like other hydroelectric plants, to respond to load changes within seconds. Pumped storage historically has been used to balance load on a system and allow large, thermal generating sources to operate at peak efficiencies. Pumped storage is the largest-capacity and one of the most cost-effective forms of grid-scale energy storage currently available.

3.1.1 Single-Speed versus Variable-Speed Technology

Historically, typical pumped storage plants used electricity to pump water to the upper reservoir during periods of low-cost, off-peak power and generate electricity during periods of high-cost, on-peak power. New pumped storage projects are envisioned to provide significant load following or ramping capability to the grid during periods of rapid changes in net load (load minus wind or solar generation) in addition to energy absorption or pumping capability during periods of excess energy generation.

In the case of conventional synchronous (single, constant speed) pump-turbine units, during generating mode, the individual units are operated to support grid requirements including load following and frequency regulation (Automatic Generation Control or AGC); however, during pumping, the units are operated at best pumping gate (most efficient operation) with no capability for load following or regulation. During pumping mode, the wicket gate positions may need to be decreased as the reservoir water elevation increases in order to keep the units on the best pumping gate curve and to prevent cavitation and vibration (net head control). Deviation from this best pumping gate operation results in low efficiency and rough operation, with minimal change in power input requirements.

Many of the proposed pumped storage projects are considering variable-speed (asynchronous) pump-turbine technology where load following is possible during both the generating and pumping modes, and hence the primary difference between the two technologies. This allows a pumped storage owner to provide grid reliability services in both pump and generate modes of operation. Variable-speed operation in this context normally means that the rotating speed of a unit does not vary by more than +/-10% of its synchronous speed. The varying output frequency of the generator is converted to the grid frequency through a special frequency conversion system. Other advantages of variable-speed units are higher and flatter generator efficiency curves, wider generating and pumping operating ranges, and easier start-up process. The main disadvantage of this technology is the higher capital costs, which are on average about 30% greater than conventional single-speed units.

Table 3 provides a summary comparing the operational characteristics and advantages/disadvantages of single and variable-speed units for an example particular project. Actual benefits will vary depending on specific site characteristics. Because of the multiple advantages, variable-speed units have been discussed in this report.

Table 3 - Example Comparison of Primary Characteristics

Characteristic	Single-speed	Variable-speed
Proven Technology	45+ years - Worldwide	10+ years - Europe and Japan
Equipment Costs	-	Approximately 10% to 30% Greater
Powerhouse Size	-	Approximately 25% to 30% Greater
Powerhouse Civil Costs	-	Approximately 20% Greater
Project Schedule	-	Longer - Site Specific
O&M Costs	-	Greater for the Power Electronics
Operating Head Range	80% to 100% of Max. Head	70% to 100% of Max. Head
Generating Efficiency		Approximately 0.5% to 2% Greater
Power Adjustment Generation Mode*	Approximately 60% to 100%	Approximately 50% to 100%
Power Adjustment Pump Mode*	None	+/- 20%
Operating Characteristics		
Idle to Full Generation	Generally Less than 3 Minutes	Generally Less than 3 Minutes
100 Percent Pumping to 100 Percent Generation	Generally Less than 6 to 10 Minutes	Generally Less than 6 to 10 Minutes
100 Percent Generation to 100 Percent Pumping	Generally Less than 6 to 10 Minutes	Generally Less than 6 to 10 Minutes
Load Following	Seconds (i.e., 10 MW per Second)	Seconds (i.e., 10 MW per Second)
Reactive Power Changes	Instantaneously	Instantaneously
Automatic Frequency Control	Yes in generate mode	Yes in both pump and generate modes
<p>*Power Adjustment: The ability of a pump-turbine generator-motor to operate away from its best operating point based on rated head and flow. Single-speed units can operate over a range of flow in the generating mode which is identical to a conventional hydropower turbine, but not in the pumping mode (in pumping mode a single speed machine cannot vary flow or wicket gate settings at all). Variable-speed units have the ability to operate the turbine's off-peak efficiency point in the pumping mode via the power electronics (no substantive change in flow), and typically have greater flexibility in the generating mode than single-speed units.</p>		

3.1.2 Open-Loop and Closed-Loop Systems

Both open-loop and closed-loop pumped storage projects are currently operating in the U.S. The distinction between closed-loop and open-loop pumped storage projects is often subject to interpretation. The Federal Energy Regulatory Commission (FERC) offers the formal definitions for these projects, and it was FERC's definitions that were followed while categorizing the pumped storage sites discussed in this report: Closed-loop pumped storage are projects that are not continuously connected to a naturally-flowing water feature; and open-loop pumped storage are projects that are continuously connected to a naturally-flowing water feature.

Closed-loop systems are preferred for new developments, or Greenfield projects, as there are often significantly less environmental issues, primarily due to the lack of aquatic resource impacts. Projects that are not strictly closed-loop systems can also be desirable, depending upon the project configuration, and whether the project uses existing reservoirs.

3.1.3 Potential Projects in PacifiCorp Service Area

For PacifiCorp’s 2013 IRP, HDR made an assessment of fifteen potential projects located within the PacifiCorp balancing area. For the 2015 IRP, three projects have been selected in consultation with PacifiCorp for further review. Projects were selected based on the preliminary filings with FERC. Figure 3 below illustrates where proposed projects in the U.S. that have been granted and/or filed for a FERC Preliminary Permit Application.

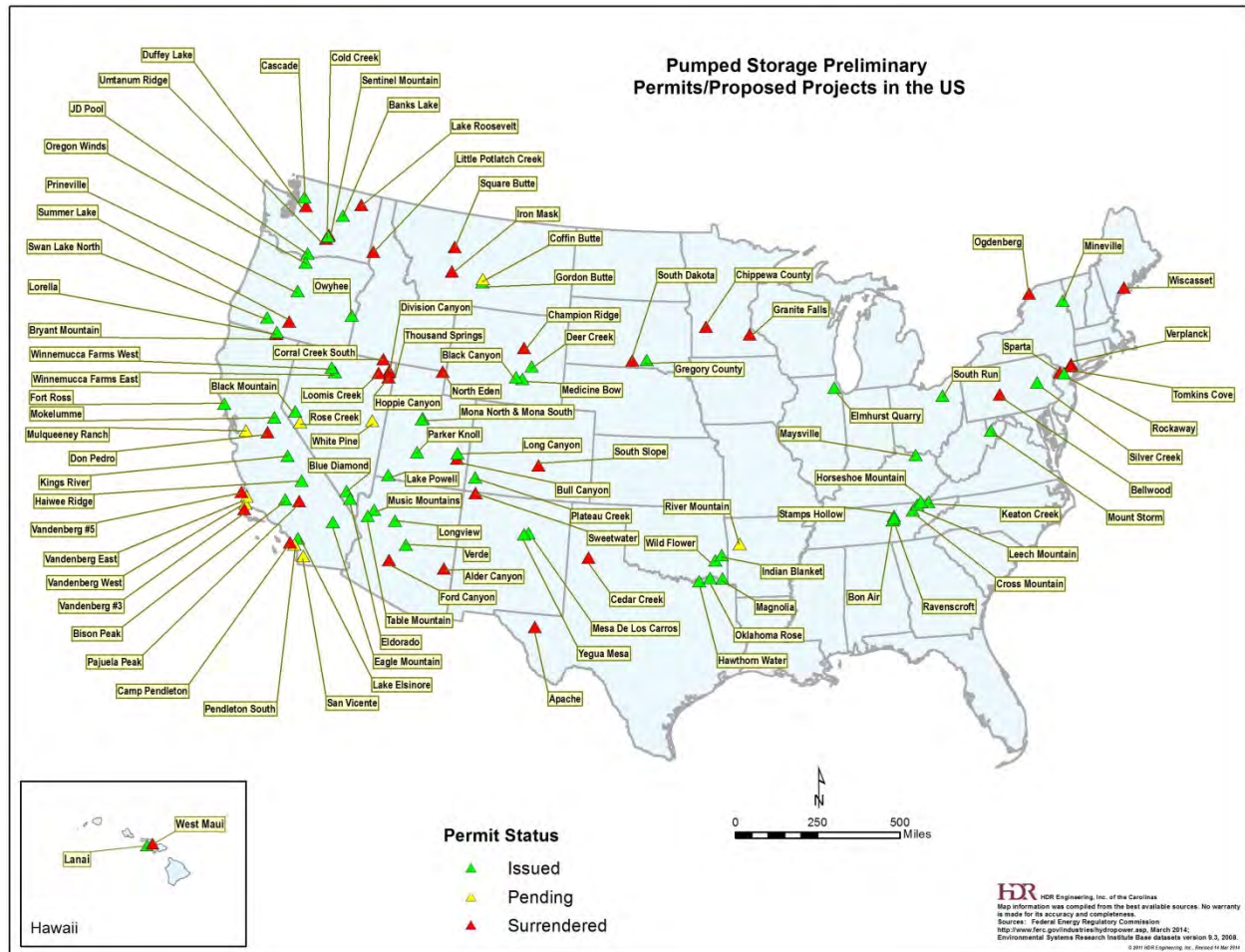

Figure 3 - Preliminary Proposed Pumped Storage Projects as of April, 2014 (HDR)

3.1.3.1 Pumped Storage Evaluation Criteria

The following is a list of pumped storage evaluation criteria utilized for this study:

Water conveyance – The tunnel length to head ratio is the single biggest variable cost component for a pumped storage project. The higher the head, the higher energy density and, as such, longer tunnel lengths are justifiable. Conversely, lower head (less than 300 feet) means that shorter tunnel lengths or a unique site configuration are required to be competitive.

Capacity- The larger the project is in terms of capacity, the lower the installed cost per kilowatt (kW) is for similar civil cost components.

Closed or open-loop- Closed-loop or off-stream embankments/dams generally means fewer regulatory challenges and a less complex FERC licensing process. Specific sites where the lower reservoir already exists may also be advantageous.

Source of water- The source of water can be complicated in extremely dry (e.g. desert southwest) or politically charged (Columbia River Basin) areas of the country.

Potential environmental/regulatory factors- Environmental and regulatory factors vary widely from site to site: these issues can range from minor challenges to a fatal flaws depending upon the project's environmental impacts.

Project location- A strong power market where ISO's are integrating large amounts of variable energy will be seeking a project that can provide grid scale ancillary services.

Transmission access- Energy evacuation and transmission line permitting is site specific and driven by a local project champion.

Geological factors- Geological factors, such as active fault lines near the proposed site, can be a project fatal flaw if known or suspected.

Technical development progress- HDR has evaluated the technical progress thus far of each project. Projects with more than a conceptual layout have been favored.

Commercial development progress- HDR has evaluated the commercial analysis of each project, as initially performed by others, and has investigated whether the developer has explored the revenue streams beyond the traditional energy arbitrage model.

Based on the above criteria, and the location of the projects within PacifiCorp's regional footprint, HDR, in collaboration with PacifiCorp, selected the JD Pool Pumped Storage Project, the Swan Lake North Pumped Storage Project and the Black Canyon Pumped Storage Project for further evaluation. These proposed sites were selected due to existing project features, environmental impacts that are fairly well understood, and the current project development status. HDR reviewed the FERC preliminary filings and subsequent six-month progress reports for each site. In addition, the developers for each project were contacted for additional information. A request for information (RFI) was developed and distributed to Klickitat Public Utility District (Klickitat) for JD Pool, EDF Renewable Energy (EDF) for Swan Lake North, and Gridflex for Black Canyon, respectively. The RFI and each developer's response are attached to this document in Appendix B. Table 4 below discusses a summary of these projects' characteristics.

Table 4 - Summary of Highlighted Pumped Storage Projects as Provided by the Project Developers

Item	Swan Lake North	JD Pool	Black Canyon
Location	Oregon	Washington	Wyoming
Approx. static head (ft)	1,188-1,318	1,900-2,100	1,063
Energy storage (MWh)	5,280	16,500	5,550
Estimated hours of storage (hrs)	8.8	11	9.5
Estimated installed capacity (MW)	600	1,500	600
Developer Provided Estimated Capital Cost (\$/kW) (See section 3.1.6 for details of HDR's Opinion of Costs)	\$2,300	\$1,700-\$2,500	\$1,500
Estimated O&M Costs (estimated as a function of capacity and annual energy. See section 3.1.6 for details)	\$9,400,000	\$19,100,000	\$9,400,000

3.1.3.2 *Swan Lake North*

The current preliminary permit for the Swan Lake North Pumped Storage Project (FERC No. 13318) updates a prior preliminary permit filed by Symbiotics. The original preliminary permit application was filed in June 2010, and was granted on August 6, 2010. The draft license application was filed on December 16, 2011. A successive preliminary permit was filed in April 2012 by Symbiotics for Swan Lake LLC so that the project developer would be able to file a Final License Application before the expiration of the preliminary permit. EDF indicated that the final license application has been drafted, but revisions are pending completion of supplemental geotechnical studies and corresponding engineering revisions in the final license application.

EDF has made a number of changes to the project layout when compared with the configuration in the active preliminary permit. EDF's project is proposed to be 600 MW in capacity, a reduction from the 1000 MW project described in the preliminary permit. The size of the reservoirs was reduced to reflect the change in capacity. EDF has also revised water conveyance arrangement to reduce the overall amount of tunneling and is considering surface penstocks. The site layout as provided by EDF is shown in Figure 4.

According to EDF, the headrace inlet/outlet structure would be located at the western end of the upper reservoir. The structure would consist of two circular bellmouth intakes to control the flow of water into two surface penstocks, approximately 2,320 feet long each. The penstocks would lead to two 572 foot long drop shafts. Horizontal headrace tunnels would connect the drop shaft to the underground powerhouse. A tailrace tunnel would be located on the southeastern end of the lower reservoir to connect the powerhouse to the lower reservoir.

The powerhouse would be located at the foot of an escarpment between two scree fields. The powerhouse would contain four pump-turbine motor-generator turbine assemblies, all associated electrical and mechanical support equipment, personnel sanitary facilities, changing and meeting rooms, a control room, and transformers. This is a shift from the preliminary permit application's design which reflected a powerhouse with separate transformer galleries.

Four reversible units would be installed in the powerhouse. Each unit would have a rated generating capacity 150 MW for a total plant rating of 600 MW. The turbine operating head range is 1,188 to 1,318 feet. EDF reports that this configuration has a storage capacity of 5,280 MWh.

The upper reservoir would be contained by a 111 foot tall, 6,560 foot long compacted rockfill dam with an asphalt concrete face. The upper reservoir would have a usable storage volume of 5,837 acre-ft. This is approximately one half the size of the upper reservoir in the active preliminary permit. The lower reservoir would be impounded by a 100 feet high, 5,245 feet long dam. The resulting reservoir would have a usable storage volume of approximately 6,000 acre-ft, which is smaller than the 11,583 acre-ft reservoir in the preliminary permit.

The project site would be accessed from Highway 140 via a private road, with Swan Lake Road as a secondary access road for vehicles approaching the project area north of Highway 140. A new, permanent 24-foot-wide haul road would be constructed up the slope of Swan Lake Rim between the upper and lower reservoirs. The haul road would be approximately 3.5 miles long.

Interconnection studies have been conducted with the Transmission Agency of Northern California (TANC) under the original 1,000 MW configuration. The study concluded that only 400 MW could be

interconnected without requiring additional transmission circuits, and the interconnection request was withdrawn. Another interconnection study was performed for PacifiCorp utilizing the 600 MW configuration. The project would connect to the northern segment of the 500 kV #2 Malin-Round Mountain line. It appears that 600 MW could be interconnected without additional circuits. EDF is currently preparing for an Impact Study with PacifiCorp and BPA.

A feasibility-level geotechnical and geophysical investigation of the project site has been performed to assess the soils and facilitate ongoing permitting. The primary objective of the investigation was to evaluate the susceptibility of the soils to liquefaction under seismic loading. Additional ongoing geo-tech testing is needed to validate assumptions and further refine the powerhouse location and conveyance alignments.

EDF documented consultation with affected agencies and stakeholders. Limited resource studies have been conducted and reportedly include:

- Water resources,
- Fish and aquatic resources,
- Botanical resources,
- Wildlife resources,
- Threatened and endangered species,
- Wetlands,
- Recreation,
- Land use,
- Cultural resources, and
- Tribal resources.

In reviewing the draft license exhibits, it appears that the studies have been performed using existing data and consultation. HDR anticipates that field studies would be the next step to further advance the project.

EDF indicated that they have developed a Class 4 cost estimate in accordance with the Association for the Advancement of Cost Engineering (AACE). Refer to Appendix B.7 for the AACE cost estimating guidelines. The estimate for the project including direct costs, engineering, construction management, licensing costs is \$1.4 billion. This is approximately \$2,300 per kW.

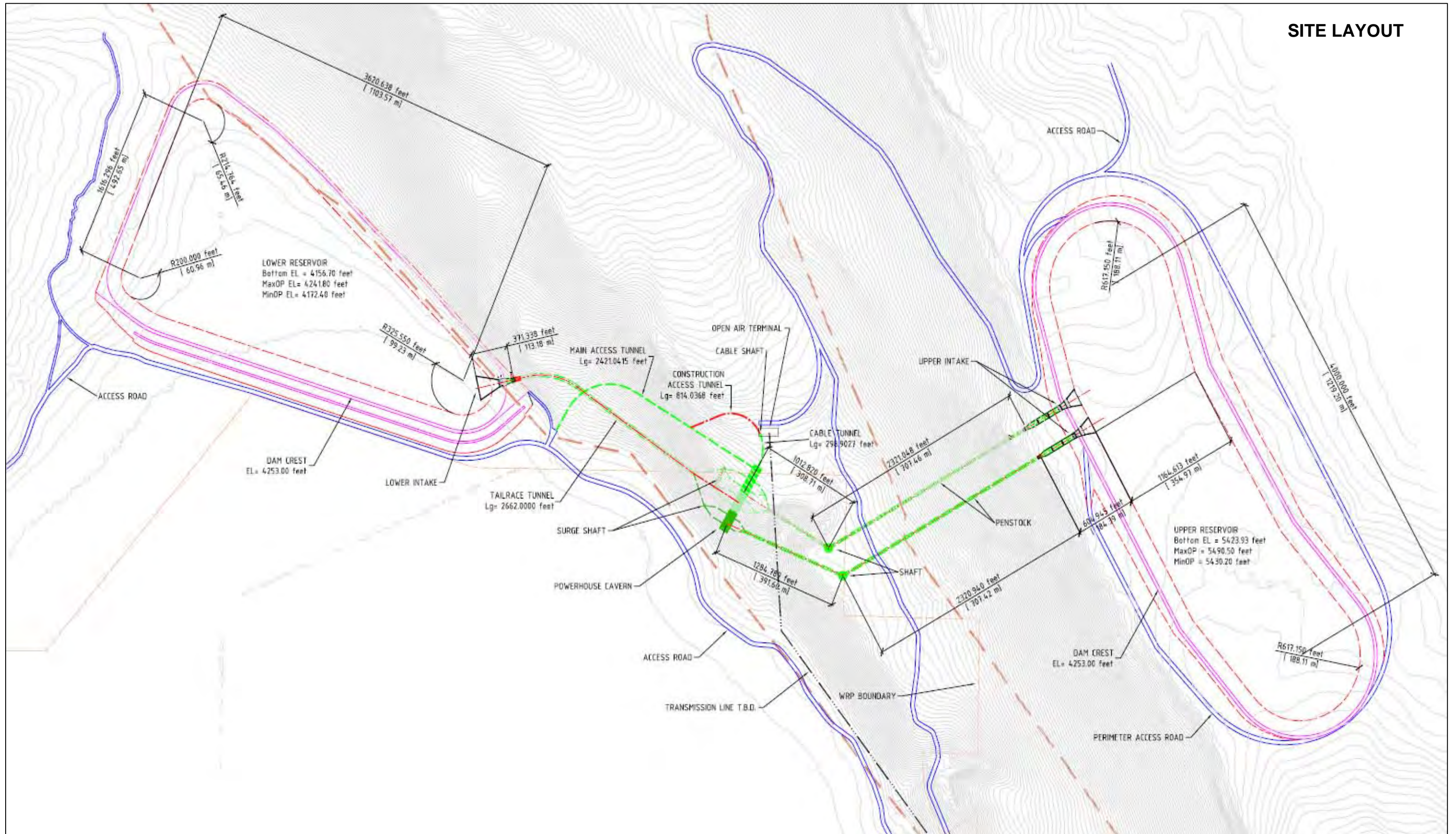

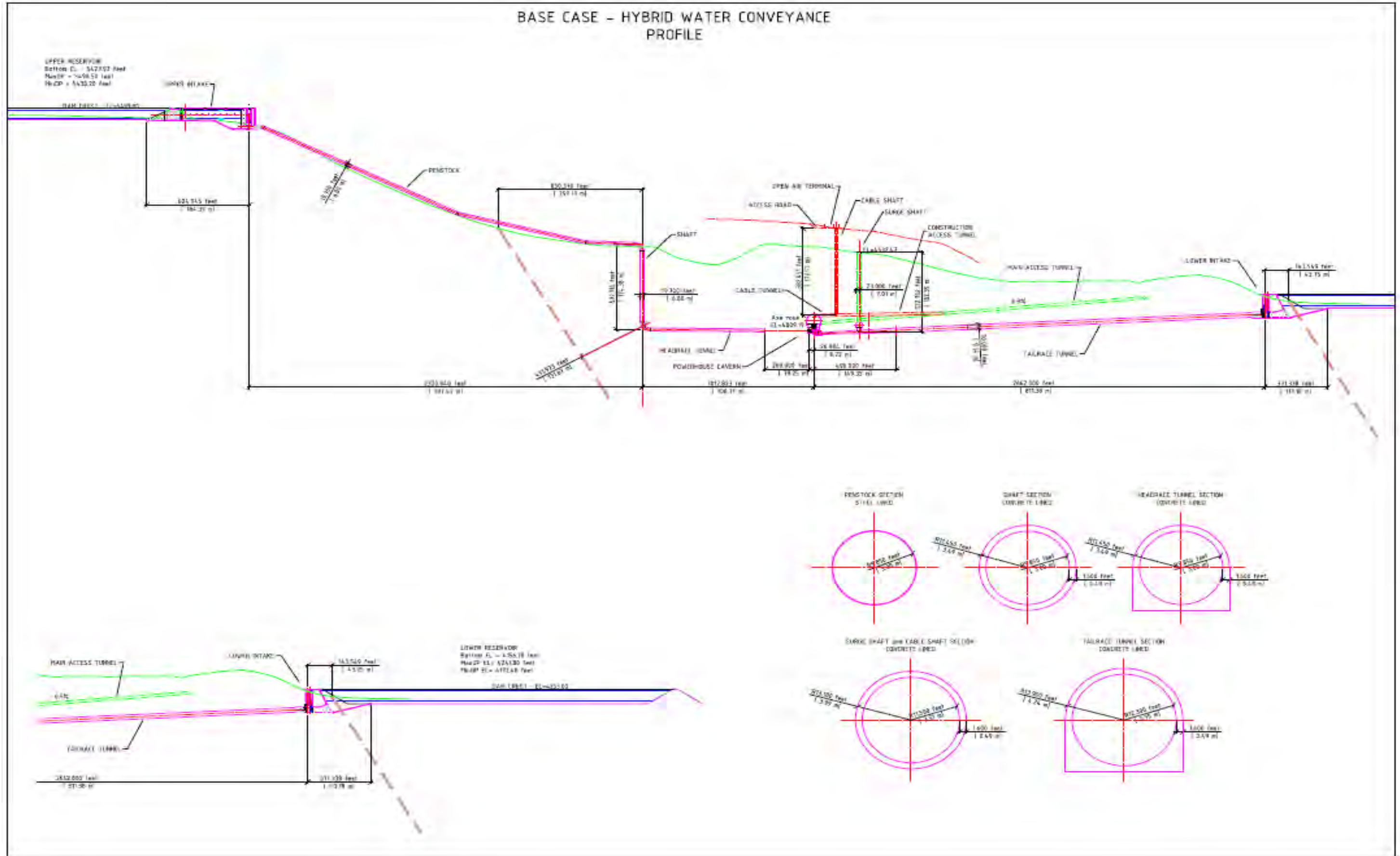

Figure 4 - Swan Lake North Site Layout and Profile (Swan Lake North Pre-Application Document)

HDR OPINION

The Swan Lake North pumped storage project has been advanced by EDF subsequent to acquiring 100 percent ownership of the project LLC. Having the ground water rights issues resolved to support initial fill is significant and the initial geotechnical investigations are a step in the right direction to advance the engineering elements.

The design decision to use surface penstocks should be carefully considered. While limiting tunnel lengths may potentially reduce tunneling capital costs, it is HDR's experience that surface penstocks are typically more costly to construct where construction access is difficult or foundation conditions may be unstable.

It should be noted that EDF France's involvement is a major factor in the potential successful execution of the project given their extensive pumped storage design and execution resume around the globe. However in the absence of any substantive off-taker agreements, the Swan Lake North project has not progressed beyond the conceptual engineering stage; and firm estimates of cost, or project fatal flaws, have not been completed.

3.1.3.3 JD Pool

The original preliminary permit application for the JD Pool Pumped Storage Project (FERC No. 13333) in the Columbia Gorge in southern Washington was filed by the Klickitat Public Utility District and Symbiotics LLC on November 20, 2008, and formed the basis of HDR's 2011 energy storage technology assessment report. A successive application was filed by Klickitat on April 30, 2012, and the information included in the revised application forms the basis of HDR's review of the project presented below.

Klickitat provided a response to the RFI that generally replicates the information in the active preliminary permit application. The JD Pool project layout appears to have been modified such that both the upper and lower reservoirs have been shifted slightly to the west. This results in a potential increase of approximately 200 to 400 feet in total head to a maximum head of approximately 2000 feet. This new upper and lower reservoir alignment is achieved via the construction of much larger reservoir embankments in terms of volume of fill material; however, engineering studies documenting the technical feasibility of the change in reservoir location do not appear to have been conducted. According to Klickitat's response to the RFI, the dam configuration, water conveyance layout, and equipment configuration have not been further developed. The project configuration below was extracted from the active preliminary permit application.

All project features associated with JD Pool would be new with the exception of the existing pumping station, associated conveyance piping and equipment from the closed aluminum smelter, which is partially located on Federal lands near the John Day Pool. A new 24 foot diameter, 9,188 foot long steel penstock is proposed, connecting the upper reservoir to the underground powerhouse. The powerhouse would consist of 5 units, 300 MW each for a proposed capacity of 1,500 MW. The turbines would be rated at 2,100 CFS and would have an operating range between 1,900 feet and 2,100 feet of head. There are two reservoirs associated with the project. The upper reservoir would require a new earth embankment with a clay core. The dam would be 270 feet high and 8,610 feet long. The upper reservoir would have a storage capacity of 14,010 acre-ft, a surface area of 114 acres, and a normal surface, elevation of 2,710 MSL. The new lower reservoir would also require an earth embankment with a clay core. The dam would be 295 feet high and 5,870 feet long. The lower reservoir reportedly would have a

storage capacity of 21,440 ac-ft (approximately 50% greater than the upper reservoir), a surface area of 110 acres, and a normal surface elevation of 705 MSL.

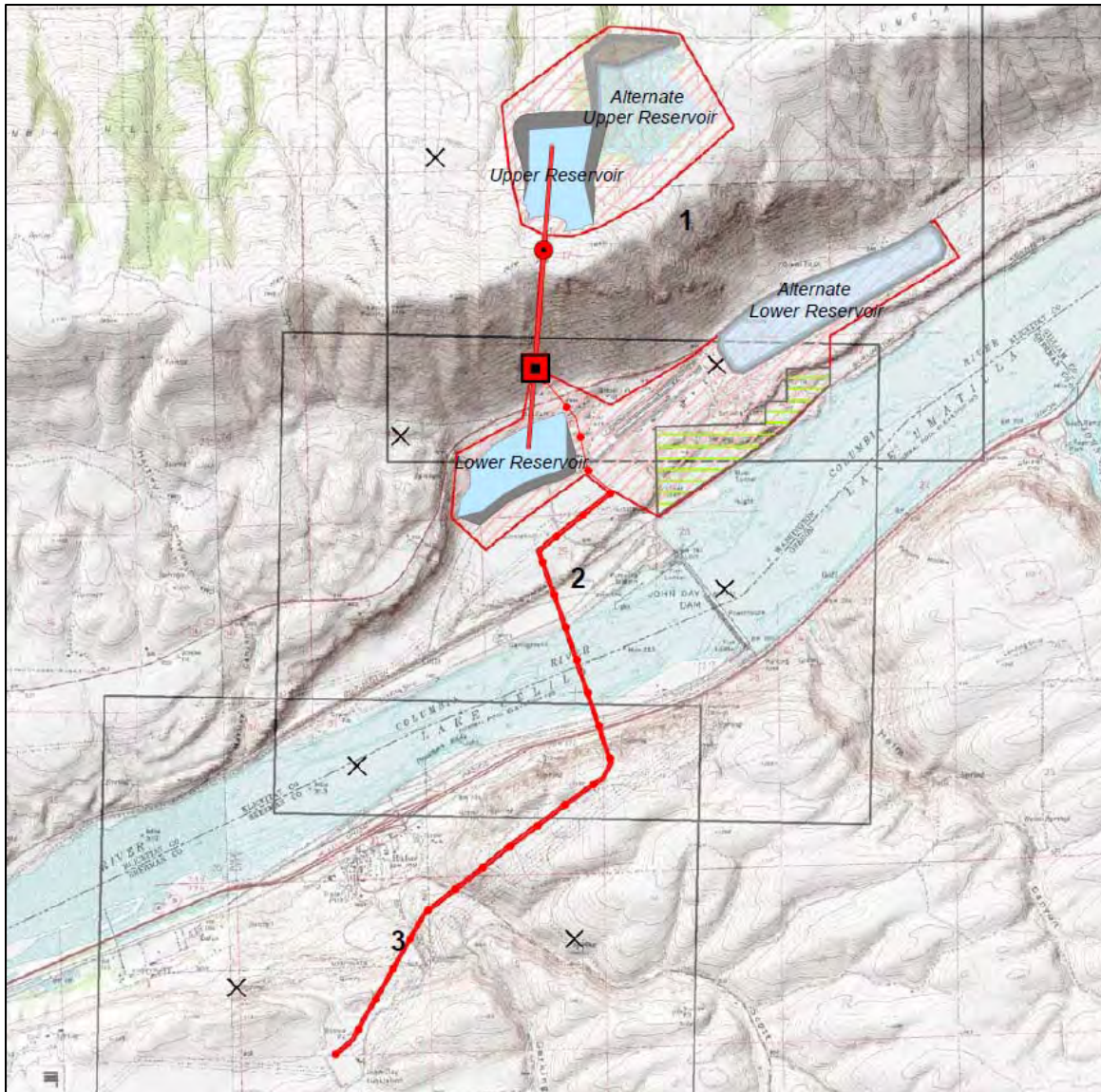

Figure 5 - JD Pool Project Layout (JD Pool Preliminary License Application)

According to the preliminary permit application, the project would interconnect with BPA's 500kV John Day substation, approximately 5 miles away from the project site via a new 500 kV line. According to Klickitat's RFI response, the project is also 8 miles from an alternate DC intertie. This project would be part of the Western Electricity Coordination Council market.

According to Klickitat, this project is still in the early stages of development, and no detailed engineering or environmental studies have taken place. Klickitat indicated that they own the water to serve the project through the Washington State Department of Ecology, and the water withdrawal facilities are part of the existing infrastructure from the former aluminum smelter located at the site. Klickitat did not provide a cost estimate at this stage of development. In 2005, HDR was involved in a reconnaissance level study and AACE Class 5 cost opinion for the Goldendale Pumped Storage Project, an early version of JD Pool.

At that time, HDR developed a cost opinion of approximately \$2.8 billion. Assuming a 3% escalation per year, cost is approximately \$3.7 billion 2014 USD, or approximately \$ 2,500 USD per kW.

HDR OPINION

HDR believes that the JD Pool pumped storage site is one of the premier sites in the Pacific Northwest for development. It is in the middle of BPA's robust high voltage transmission corridor, it can be developed in an environmentally benign manner, and the associated topography supports a high energy density design.

The project status at this time, however, is still at the conceptual stage with no advancements in engineering trade-off studies or environmental and resource assessments. An example of a project disconnect is the disparity between the storage volumes of the upper and lower reservoir as indicated in the active preliminary permit; ideally they would be equal in a closed loop system. There have not been any field studies to date, and Klickitat indicated they are actively searching for a development partner. The lack of progress on the regulatory requirements does put the project developer at risk for being able to maintain the active preliminary permit.

3.1.3.4 Black Canyon

The preliminary permit application for the Black Canyon Pumped Storage Project (FERC No. P-14087) was prepared by Gridflex Energy, LLC and was filed by Black Canyon Hydro, LLC on January 25, 2011. The application currently shows four alternatives for development. See Figure 4 for the project layout. Two new upper reservoirs, the East Reservoir and the North Reservoir, could be connected to one of two existing lower reservoirs, the Seminoe Reservoir and the Kortes Reservoir. The developer may select one or a combination of the alternatives.

In their response to the RFI, Gridflex indicated that their preferred alternative at this time connects the East Reservoir and the existing Seminoe Reservoir. The other three configurations, however, are still under consideration. The project description below was extracted from the active preliminary permit application. Based upon the RFI response, it appears that Gridflex revised the project sizing for Black Canyon from the preliminary permit application. In the FERC filing, the project is described as a 400 MW plant with reportedly an additional 100 MW of pumping capacity. In the RFI submittal, Gridflex presents a 600 MW project for the same preferred alternative with no additional pumping capacity. The change appears to be in the unit sizing and not the configuration of the dams and reservoirs.

The East Reservoir would be connected to the Seminoe Reservoir by approximately 6,800 feet of conduit. Maximum hydraulic head for the project would be 1,063 feet. A 20.4 ft diameter low pressure tunnel would extend for 800 ft and connect to a 5,800 ft long pressure shaft to the powerhouse. A 200 ft long section of tailrace tunnel would connect the powerhouse to the lower reservoir. The penstock configuration was not addressed in Gridflex's response to the RFI.

The powerhouse would be located approximately 200 feet east of the Seminoe Reservoir. Gridflex indicated that an underground powerhouse is preferred in the RFI submittal. HDR concurs with this underground cavern concept where the project is planning to utilize an existing lower reservoir due to constructability. However, in HDR's opinion, the powerhouse is proposed to be located very close to the existing lower reservoir and appears to be a shoreline powerhouse configuration, and the constructability of the powerhouse should be carefully evaluated.

Also the sizing of the pump-turbine generator-motor units differs between the RFI and the preliminary permit application. According to the preliminary application, three 133 MW adjustable-speed reversible pump-turbines would be utilized for 400 MW of generating capacity. The units would be capable of an additional 100 MW of additional pumping capacity. In Gridflex's RFI response, a 600 MW project is described for the same East Reservoir-Seminole alternative without any additional capacity during pumping operation. In their submittal, the developer reported that the units would provide 100-200 MW each in the pump mode and 50-200 MW in the generating mode, but HDR's experience with pump-turbines indicates that this operating range is not realistic, including the most advanced variable speed technology.

The proposed East upper reservoir would consist of a new 50 ft ring dam and would be 8,724 ft long and impound a 9,700 acre-ft reservoir. The lower reservoir for this project would be the existing Seminole Reservoir. The reservoir is 1,016,717 acre-ft and is impounded by Seminole dam, an existing 295 ft high concrete arch dam.

The project would interconnect with the Western Area Power Administration (WAPA) Miracle Mile-Cheyenne line near the Seminole Dam. This line runs through the Medicine Bow area, where energy from the project would be transferred to one of several planned terminals for new transmission facilities. These include the Gateway West line (PacifiCorp) via the Aeolus substation, the Zephyr line, the TransWest Express, and the Overland. The interconnection point would be adjacent to the project powerhouse.

The project would utilize the water resources of the North Platte River as stored and transferred through the Seminole and Kortes Reservoirs.

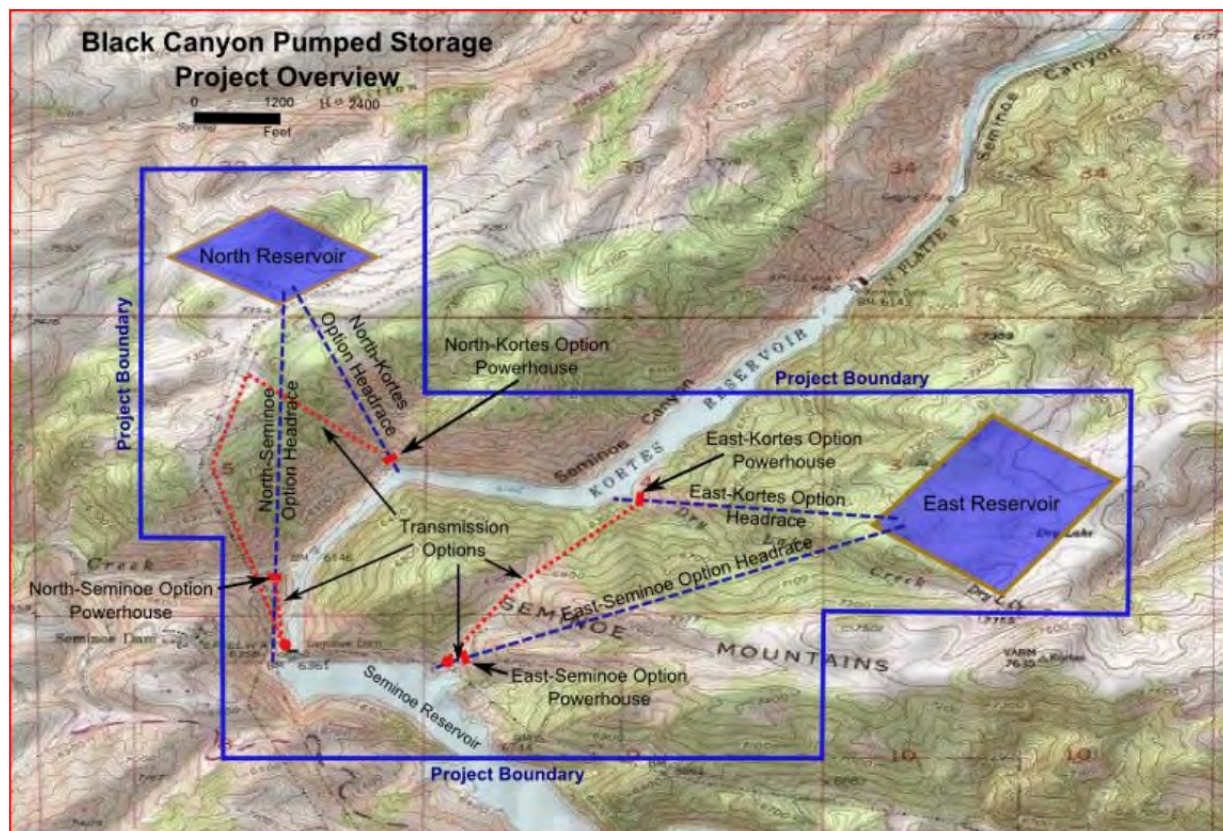

Figure 6 - Black Canyon Layout (Black Canyon Preliminary Permit Application)

The developer has indicated that they intend to purchase water rights from adjacent land owners who are existing water rights holders. In HDR's experience, the acquisition of water rights can be a lengthy and difficult process depending upon the geographic region and stakeholder interests. Both upper reservoirs would be located on land managed by the Bureau of Land Management (BLM), as would a part of the conduit path. The existing Kortez and Seminoe Reservoirs and dams are owned and operated by Reclamation. Study plans have not been developed yet, but Gridflex reported that they have consulted with both the BLM and Reclamation.

Gridflex indicated that their project an AACE Class 4 or 5 cost estimate of approximately \$883 million dollars, which is about \$1,500 per kW. This appears to be low given the stage of development of the project. In HDR's opinion, the level of engineering demonstrated by Gridflex's response to the RFI does not fully reflect the potential construction costs of a new upper reservoir, powerhouse, prime mover elements and other extensive balance of plant systems, plus the water conveyance system. The engineering and licensing also appears to be low, at only 7% of the project construction cost. Gridflex included construction management in the direct project cost, but in HDR's experience this typically represents an additional cost and should be listed separately. For this level of project development, HDR would expect project contingency to be in excess of 30% for a Class 4 or 5 cost estimate rather than the 20% reflected in Gridflex's response. Gridflex indicated that a renewable integration study has been conducted with Wyoming wind data, but the report was not attached to the RFI response. The developer indicated that the project could be operational as early as 2020, but from the level of engineering development and licensing progress, this date does not appear to be achievable to HDR.

HDR OPINION

The Black Canyon project is the least advanced of the three pumped storage projects investigated for this report, and significant additional feasibility work needs to be done to determine if the project is viable. It does not appear that any engineering alternatives analyses or preliminary desktop geological assessments have been completed to further refine the site or to identify potential geological fatal flaws. The concept of a shoreline powerhouse next to an existing lower reservoir should be refined to demonstrate that required unit submergence can be achieved. The reported unit operating parameters also require further clarification.

The constructability of a shoreline powerhouse near an existing reservoir should be carefully considered. Pump-turbines typically require submergence, or setting of the centerline of the pump-turbine approximately 10% of the gross head below the minimum tailwater elevation. This equates to approximately 100 feet for Black Canyon just for unit submergence alone. The resulting very deep excavation required near an existing body of water would potentially create significant water management issues during construction.

The reported costs appear to be low based upon HDR's industry experience and the current market prices for the prime movers and the extensive balance of plant systems. The project timeline for construction and commissioning is also unrealistic based upon HDR's industry experience, and do not appear to be based on advanced engineering or environmental studies. These studies would include analysis of existing infrastructure, site specific geology, transmission interconnect studies, resource (e.g. botanical, aquatic, land use, cultural) studies, and other factors critical for determining the technical and economic feasibility of a new pumped storage project.

3.1.4 Operating Characteristics

The pumped storage projects in development are driven by the opportunity to capitalize on the anticipated markets for energy arbitrage and ancillary services. Energy arbitrage refers to the practice of utilizing electric energy during the lower priced hours of excess energy to pump water from a lower reservoir into the upper reservoir. The water is then stored in the upper reservoir for potential use. When energy prices are higher, water is released from the upper reservoir through the turbines, and electricity is generated and sold at these higher prices. Energy arbitrage results in higher net income when the difference between on-peak and off-peak prices is greatest.

The projects would also provide ancillary services in both operating modes. FERC has defined ancillary services as, “those services necessary to support the transmission of electric power from seller to the purchaser given the obligations of control areas and transmitting utilities within those control areas to maintain reliable operations of the interconnected transmission system” (FERC 1995). As described above, variable-speed units are more suitable for providing ancillary services than single-speed units, particularly frequency regulation. The projects could provide the following services:

- **Spinning Reserves** - Reserve capacity provided by generating resources that are running (i.e., “spinning”) with additional capacity that is capable of ramping over a specified range within 10 minutes and running for at least two hours. Spinning Reserves are needed to maintain system frequency stability during periods of energy imbalance resulting from unanticipated variations in load, or variable energy supply. Reserves are also required to respond to emergency operating conditions created by forced outages of scheduled units.
- **Non-Spinning Reserves** - Generally, reserve capacity provided by generating resources that are available but not rotating. These generating resources must be capable of being synchronized to the grid and ramping to a specified level within 10 minutes, and then be able to run for at least two hours. Non-Spinning Reserves are needed to maintain system frequency stability during emergency conditions.
- **Regulation** - Reserve capacity provided by generating resources that are running and synchronized with the grid, so that the operating levels can be increased (incremented) or decreased (decremented) instantly through Automatic Generation Control to allow continuous balance between generating resources and demand.

3.1.5 Regulatory Overview

Some of the most important aspects in the evaluation of siting and development of a potential pumped storage project are the environmental and regulatory factors. All pumped storage project development by non-federal entities requires the project developer to go through the FERC licensing process, which is expected to take approximately three to five years. For some projects, the potential issues associated with project development may be fatal flaws, for others the mitigation measures are minimal and manageable. Many of the most promising new pumped-storage sites identified by the hydropower industry are closed-loop pumped-storage. It is generally accepted within the industry that a Greenfield closed loop pumped storage project could be licensed in less than five years as many of the environmental and resource issues can be relatively easily mitigated.

Environmental and resource concerns may include fisheries issues (e.g. entrainment or, impingement), site clearing and construction impacts, impacts to recreation, and land use concerns. For closed-loop systems, there is no water discharged from the station into the main-stem river as a result of routine unit operations and the historical concerns regarding fish entrainment and impingement at conventional hydropower stations is thereby avoided. With respect to site clearing and other land use concerns new large pumped-storage plants typically consist of an underground powerhouse and, thus, mitigate to a large degree the overall footprint of the station. But these hydroelectric projects generally require construction of roads, main or saddle dams, spillways, transmission lines, and other aspects that may alter the existing landscape.

3.1.6 Capital, Operating, and Maintenance Cost Data

3.1.6.1 Capital Cost

The following discussion is applicable to pumped storage projects with which HDR is familiar, and does not necessarily reflect the three projects discussed above. Nonetheless, the three projects appear to fall in the range of reasonable cost for similar pumped storage projects. The direct cost to construct a pumped storage facility is highly dependent on a number of physical site factors, including but not limited to topography, geology, regulatory constraints, environmental resources, project size, existing infrastructure, technology and equipment selection, capacity, active storage, operational objectives, etc. According to the HDR database, one could expect the direct cost of a pumped storage facility utilizing single speed unit technology to be in the order of \$1,700 to \$2,500 per kW. The direct cost for a facility utilizing variable speed unit technology is expected to be approximately 10 to 20 percent greater than that of a facility utilizing single speed technology. Direct costs include:

- Cost of materials
- Construction of project features (tunnels, caverns, dams, roads, etc.)
- Equipment
- Labor for construction of structures
- Supply and installation of permanent equipment
- Procurement of water rights for reservoir spill and make up water

Indirect costs generally run between 15 and 30 percent of direct costs and are largely dependent on configuration, environmental/regulatory, and ownership complexities and include cost such as:

- Preliminary engineering and studies (planning studies, environmental impact studies, investigations),
- License and permit applications and processing,
- Detailed engineering and studies,
- Construction management, quality assurance, and administration,
- Bonds, insurances, taxes, and corporate overheads.

HDR has summarized the cost opinions for the three selected pumped storage projects.

For Swan Lake North, EDF provided a cost estimate of \$2,300 per kW. In 2012, HDR prepared a Class 4 cost opinion at the request Symbiotics for Swan Lake North. HDR's cost opinion at the time was

between \$2 billion and \$2.3 billion. When HDR's cost opinion is escalated using a rate of 3% per year, it appears to be consistent with EDF's response to the RFI.

HDR conducted a reconnaissance level study and a Class 5 cost opinion for the Goldendale Pumped Storage Project, which was an early version of the current JD Pool Pumped Storage Project. HDR's cost opinion was on the order of \$2.8 billion in 2005. The cost estimate was escalated at a rate of 3% per year, which yields \$3.7 billion in 2014 USD. Klickitat PUD did not provide a cost estimate in their response to the RFI. In the Preliminary Permit Application, however, a cost opinion of \$2 billion to \$2.5 billion was provided. The cost opinion was for a 1,000 to 1,200 MW project, which equates to \$1,700 to \$2,500 per kW. It appears that Klickitat PUD's cost opinion is budgetary in nature, and HDR could not verify that the cost opinion conformed to the AACE guidelines as there was no breakdown provided. HDR expects that the total project cost for JD Pool could be on the order of \$2,000 to \$2,500 per kW.

Based on cost opinions developed for similar pumped storage projects, HDR expects that the construction cost for Black Canyon could be on the order of \$2,000 per kW. The \$1,500 per kW reported by Gridflex appears to low to cover both direct and indirect costs. It is also low when compared to cost opinions for other pumped storage projects.

For Swan Lake North and JD Pool, the developer's cost estimate seems reasonable given the early stage of development for each project. The cost estimate provided by Gridflex for Black Canyon appears low. This comparison is summarized in Table 5 below.

Table 5 - Comparison of Cost Opinions

Item	Swan Lake North	JD Pool	Black Canyon
HDR Cost Opinion (\$/kW)	\$2,100 - \$2,400	\$2,500	\$2,000 - \$2,300
Developer Estimated Capital Cost (\$/kW)	\$2,300	\$1,700 - \$2,500	\$1,500

3.1.6.2 Annual Operation and Maintenance (O&M) Costs

Operation, maintenance, and outage costs vary from site to site dependent on specific site conditions, the number of units, and overall operation of the project. For the purposes of this evaluation, a generic four unit, 1,000 MW underground powerhouse has been assumed. As seen from the project examples above, this is a common arrangement selected for a pumped storage project.

Previous Electric Power Research Institute (EPRI) studies provide the following equation for estimating the annual operations and maintenance (O&M) costs for a pumped storage project in 1987 dollars:

$$\text{O\&M Costs (\$/yr)} = 34,730 \times C^{0.32} \times E^{0.33}$$

Where: C = Plant Capacity, MW

E = Annual Energy, GWh

This methodology is considered valid and an escalation multiplier of 2.06 is recommended to escalate 1987 costs to 2014. In addition, the following additional annual costs are recommended:

- Annual general and administration expenses in the order of 35% of site specific annual O&M costs, and
- Annual insurance expenses equal to approximately 0.1% of the plant investment costs, or capital cost.

For a 1,000 MW pumped storage project costing \$2,500 per kW, generating 6 hours per day 365 days per year, and annual energy production of 2,190 GWh. The calculated annual O&M, administrative, and insurance costs are approximately \$13.6 million in 2014 USD.

3.1.6.3 Bi-Annual Outage Costs

In addition to annual O&M costs, it is recommended within the industry that bi-annual outages be conducted. Again, the frequency of the inspections and the subsequent repairs following inspections can vary depending upon how the units are operated, how many hours per year the units will be on-line, how much time has elapsed since the last inspection/repair cycle, the technical correctness of the hydraulic design for site specific parameters, and water quality issues.

Conservatively, in a four unit, 1,000 MW powerhouse, two units would be taken out of service for approximately a three week outage every two years. For units of this size, \$262,000 for two units should be budgeted.

3.1.6.4 Major Maintenance Costs

It is recommended within the industry that a pump-turbine overhaul accompanied by a generator rewind be scheduled at year 20. The typical outage duration is approximately six to eight months. Pumped storage units are typically operated twice as many hours or more per year than conventional generating units if utilized to full potential. This increased cycling duty also dramatically increases the degradation of the generator components. This increased duty results in the requirement to perform major maintenance on a more frequent basis.

The work included and the frequency of this outage can vary based on project head, project operation, and regular maintenance cycles. Overhauls typically include restorations of all bushings and bearings in the wicket gate operating mechanism, replacement of wicket gate end seals, rehabilitation of the wicket gates including non destructive examination (NDE) of high-stress areas, rehabilitation of the servomotors, replacement of the runner seals, NDE of the head cover, restoration of the shaft sleeves and seals, and rehabilitation of the pump-turbine bearing. The end result is restoring the pump-turbine to like-new running condition. Pump-turbine inlet isolation valves will likely require refurbishment of the valve seats and seals. The service life of a generator-motor is generally dependent upon the condition of the insulation in the stator and rotor. The need for re-insulation of the stator and rotor, typical of a salient pole design, can vary from 20 to 40 years depending upon the duty cycle and insulating materials utilized.

The costs for these modifications depend on many factors. Due to the complexity of the scope, an estimate must be developed for each installation. For the purposes of this study, approximately \$6.28 million was estimated for reversible Francis units at year 20.

3.2 Batteries

3.2.1 Battery Energy Storage Technology Description

Battery energy storage systems are functionally electrochemical energy storage devices that convert energy between electrical and chemical states. Electrode plates consisting of chemically-reactive materials are situated in an electrolyte which allows the directional movement of ions within the battery. Negative electrodes (cathodes) give up electrons (through electrochemical oxidation) that flow through the electric load connected to the battery, and finally return to the positive electrodes (anodes) for electrochemical reduction. This basic direct current (DC) can be inverted into the desired alternating current (AC) frequency and voltage.

Certain battery technologies have significant exposure in various markets including telecom, end-user appliance, automotive, and on a larger scale, utility applications. Batteries are becoming one of the faster-growing areas among utility energy storage technologies in frequency regulation applications, renewable energy systems integration, and in remote areas and confined grid systems where geographical constraints do not fit well with the application of hydroelectric storage or CAES. Batteries have surpassed CAES in stored energy capacity to total an estimated 556 MW, or 0.36% of global storage capacity in 2012.

Electric utility companies as well as large commercial and industrial facilities typically utilize battery systems to provide an uninterrupted supply of electricity to power a load (e.g. substation, data center) and to start backup power systems. In the residential and small commercial sector, conventional use for battery systems includes serving as backup power during power outages.

Common types of commercialized rechargeable and stationary battery technologies include, but are not limited to, the following:

- Sodium sulfur (NAS)
- Dry Cell
- Advanced lead acid (Pb-acid)
- Family of lithium ion chemistries (Li-ion)
- Flow - Vanadium redox (VRB)
- Flow - Zinc bromide (ZnBr)

In physical form, these battery types are modular and enclosed in a sealed container, with the exception of flow batteries. Flow batteries' distinguishing characteristic is their independent and isolated power and energy components, comprised of cell "stacks" and tanks to hold the electrolyte. They operate by flowing the electrolyte through cell stacks to generate electrical current.

3.2.2 Manufacturers and Commercial Maturity of Technology

All of these batteries types have the technical potential for penetration into specific utility markets and applications. The remainder of this section discusses battery technologies that are considered suitable for specific utility applications. Due to the limited scope of this study, only information collected from manufacturers representing select battery technology is presented. The six manufacturers included in this study, based on their deployment on utility systems, are:

- Lithium ion (Li-ion) - A123 Systems, Inc. (A123)

- Sodium sulfur (NAS) – NGK Insulators, Ltd. (NGK)
- Vanadium redox battery (VRB) – Prudent Energy Corporation (Prudent)
- PowerCells™ – Xtreme Power, Inc. (Xtreme)
- Zinc bromine (ZnBr) – Premium Power Corporation (Premium)
- Advanced Lead Acid (Pb-Acid) – Ecoult Energy Storage Solutions (Ecoult)

3.2.2.1 Lithium Ion (Li-ion) – A123 Systems, Inc. (A123)

Li-ion and lithium polymer-type batteries have been widely used in end-user appliances (e.g. consumer electronics) and have become the de facto energy storage system in the electric vehicle industry (e.g. hybrids and electric vehicles). Within the battery itself, lithiated metal oxides make up the cathode and carbon (graphite) make up the anode. Lithium salts work as the electrolyte. In a charged battery, lithium atoms in the cathode become ions and deposits in the anode. An example chemical balance can be characterized as:



Li-ion batteries are known for having high energy density and low internal resistance, making efficiencies (defined as round trip AC out to AC in) upwards of 90% possible. This technology is very attractive for mobile applications and potentially utility power quality applications. An external heating or cooling source may be required depending on ambient conditions and system operation to maintain their operating temperature range of 20 to 30 °C. A123 projects are focused on renewables firming and ramp management, frequency regulation, and T&D and substation support. Projects in their portfolio have less than 1 hour of energy storage with the exception of a 4-hr wind integration plant. Since 2009, seven projects have been installed in the US with capacity of 69 MW / 47.5 MWh. The largest projects include 20 MW / 5 MWh in Johnson City, NY and 8 MW / 32 MWh in Tehachapi, CA. Currently under development (Figure 8) is a 32 MW / 8MWh system in Oro Mountain, WV. This technology is classified as commercial because it has been implemented in the utility markets.



Figure 7 - A123 Li-ion Cells



Figure 8 - Renewable Integration Deployment in West Virginia

3.2.2.2 Sodium Sulfur (NaS) – NGK Insulators, Ltd. (NGK)

In its simplest form, a NaS battery consists of molten sulfur positive electrode and molten sodium negative electrode, separated by a solid beta-alumina ceramic electrolyte (Figure 9). In the discharge cycle, the positive sodium ions pass through the electrolyte and combine with sulfur to form sodium polysulfides. During the charge cycle, the sodium polysulfides in the anode start to ionize to allow sodium formation in electrolyte according to:

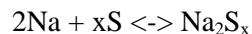

Among the prevalent technologies, NaS batteries have high energy densities that are only lower than that of Li-ion. The efficiency of NaS varies somewhat dependent on duty cycle due to the parasitic load of maintaining the batteries at the higher operating temperature of 330degrees Celsius. However, the battery modules are packaged with sufficient insulation to maintain the battery in its hot operating state for periods of several days in a “standby” mode. NGK projects are focused on island / peak shaving applications, and solar integration. Projects in their portfolio are multiple-hour systems. The first project was 0.5 MW for a TEPCO Kawasaki substation in 1995. Installations now include over 120 international projects with capacity of 190 MW and 1,300 MWh. The largest project is 12 MW / 86.4 MWh at a Honda facility Japan, installed in 2008 (Figure 10). As of 2010, six projects in the US with 14.75 MW / 73.2 MWh have been installed, with the largest project being 4 MW / 24 MWh in Presidio, TX (2010). Five projects totaling 7.9 MW / 23.2 MWh are planned throughout the US. This technology is mature, given its large number of installations, especially in Japan, and the many years of research and development targeted for utility energy storage applications.

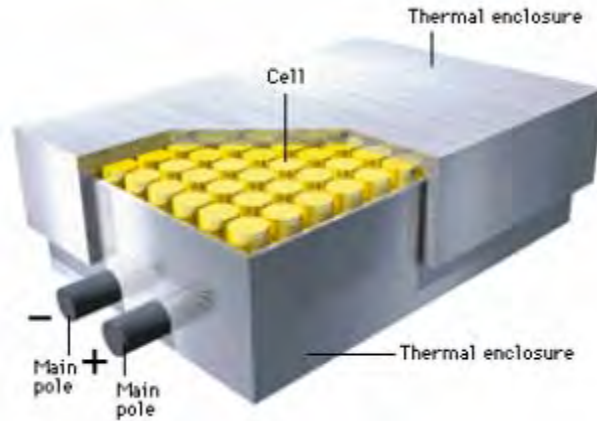

Figure 9 - NAS Cell Module



Figure 10 - NGK NAS 8 MW (Japan)

3.2.2.3 Vanadium Redox Battery (VRB) – Prudent Energy Corporation (Prudent)

VRB systems use electrodes to generate currents through flowing electrolytes. The size and shape of the electrodes govern power density, whereas the amount of electrolyte governs the energy capacity of the system. The cell stacks comprise of two compartments separated by an ion exchange membrane. Two separate streams of electrolyte flow in and out of each cell with ion or proton exchange through the membrane and electron exchange through the external circuit. Ionic equations at the electrodes can be characterized as follows:

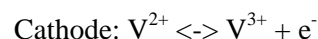
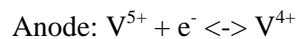

VRB systems are recognized for their long service life as well as their ability to provide system sizing flexibility in terms of power and energy. Representative images of VRB technology is shown in Figure 11 and Figure 12. VRB efficiency tends to be in the range of 70-75%. The separation membrane prevents the mix of electrolyte flow, making recycling possible. Prudent projects are focused on solar and wind

integration, and island / peak shaving. Projects in their portfolio are multiple-hour systems. The first US project utilizing VRBs was Rattlesnake #22 with PacifiCorp in Castle Valley, UT with 0.250 MW / 2 MWh installed in 2004. The VRBs were installed in order to increase capacity and reliability of a 25kV feeder without any major environmental impacts. Additional information is available in Appendix C. In 2009, a 0.6 MW / 3.6 MWh system was installed at Gills Onion plant, CA. Two other projects are in development in CA, with combined nameplate capacity of 2.2 MW. This battery technology is classified to be in its nascent commercialization stage as there has been only a handful of utility-scale implementations, although the technology itself has been in development for 20 years.

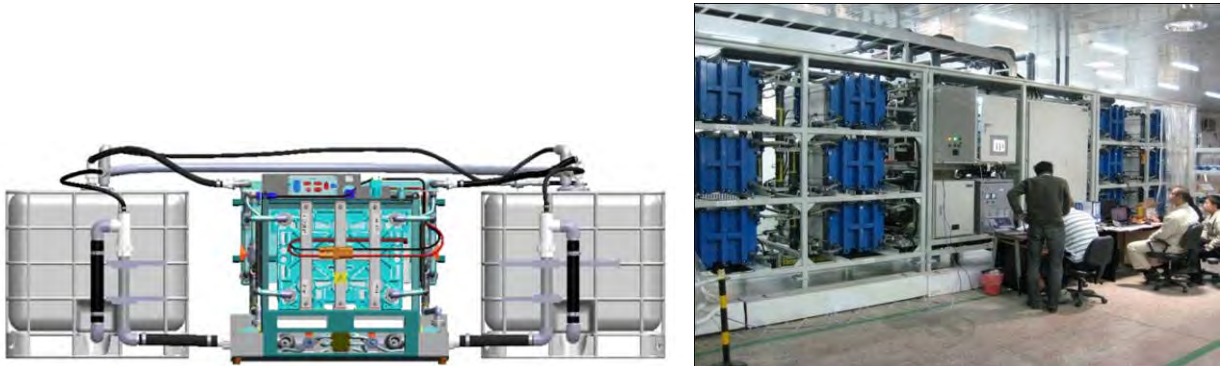

Figure 11 - VRB Cell Stack and Electrolyte Tanks

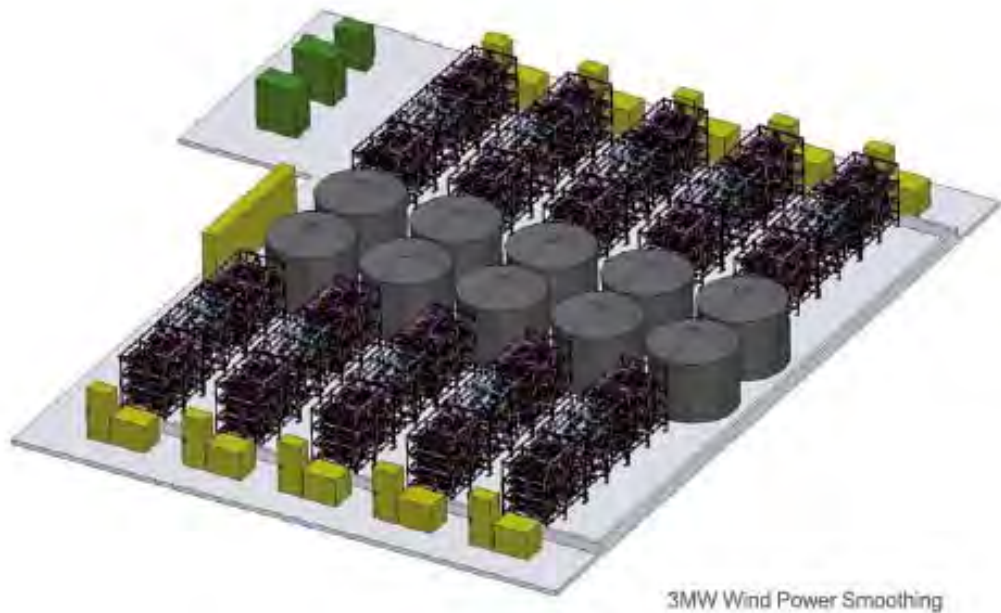

Figure 12 - Standard VRB Plant Design 3 MW

3.2.2.4 Dry Cell – Xtreme Power, Inc. (Xtreme)

Xtreme Power's PowerCells™ were first developed over two decades ago and bears the signature characteristic of having one cell store 1 kWh worth of energy at ultra-low internal impedance. The cells were developed to maximize nano-scale chemical reactions by providing electrode plates with large surface areas. Representative images of Dry Cell technology is shown in Figure 13 and Figure 14.

These cells are solid state batteries developed from dry cell technology. Dry cells have been recognized in the industry for its high energy density and capacity as well as quick recharge times. Similar to the li-ion technology, dry cells have found success in the hybrid vehicle market and are considered to be a commercial technology in the utility industry.

Xtreme works with wind and solar integration and offers peak shaving / load leveling. Projects in their portfolio range from sub-hourly to multiple-hour systems. The first installation of 0.5 MW / 0.1 MWh was a test facility in Antarctica for microgrid peak shaving completed in 2006. A 1.5 MW / 1 MWh test facility was installed in Maui, HI for renewable integration in 2009. Today, Xtreme has over 78 MW of capacity installed, over 25,000 MWh charged and discharged, and has completed renewable integration projects for Kaheawa Wind Power (Hawaii) on the scale of 10 MW with a 45 minute duration.



Figure 13 - PowerCell™ Stacks with PCS



Figure 14 - DPR15-100C Container

3.2.2.5 Zinc Bromine (ZnBr) – Premium Power Corporation (Premium)

The fundamental of energy conversion for ZnBr batteries is the same as that of VRBs. Two separate streams of electrolyte flow in and out of each cell compartment separated by an ion exchange membrane. Ionic equations at the electrodes can be characterized as follows:

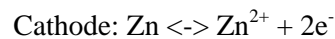
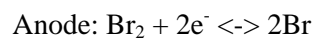

Like VRBs, ZnBr batteries are also recognized for their long service life and flexible system sizing based on power and energy needs. The separation membrane prevents the mix of electrolyte flow, making recycling possible. ZnBr efficiency is in the 60% range. Premium is focused on power quality, island / UPS applications, and on peak shaving / load leveling projects. Projects in their portfolio are multiple-hour systems. To date, 6.9 MW / 17.2 MWh has been installed in the US. Five recent projects, two in CA and three in MA, have been installed or are under development, rated at 0.5 MW / 3 MWh each. Like the VRB systems, ZnBr battery technology is considered in its early stages of commercialization. At the time of writing, there was no publicly available information on any of its electricity storage plants; the number and size of projects installed to date were provided by Premium. Figure 15 illustrates Premium's standard cell stack. Figure 16 shows Premium's TransFlow2000, a complete ZnBr battery system, complete with cell stacks, electrolyte circulation pumps, inverters and thermal management system configured into a standard trailer.



Figure 15 - ZnBr Cell Stacks

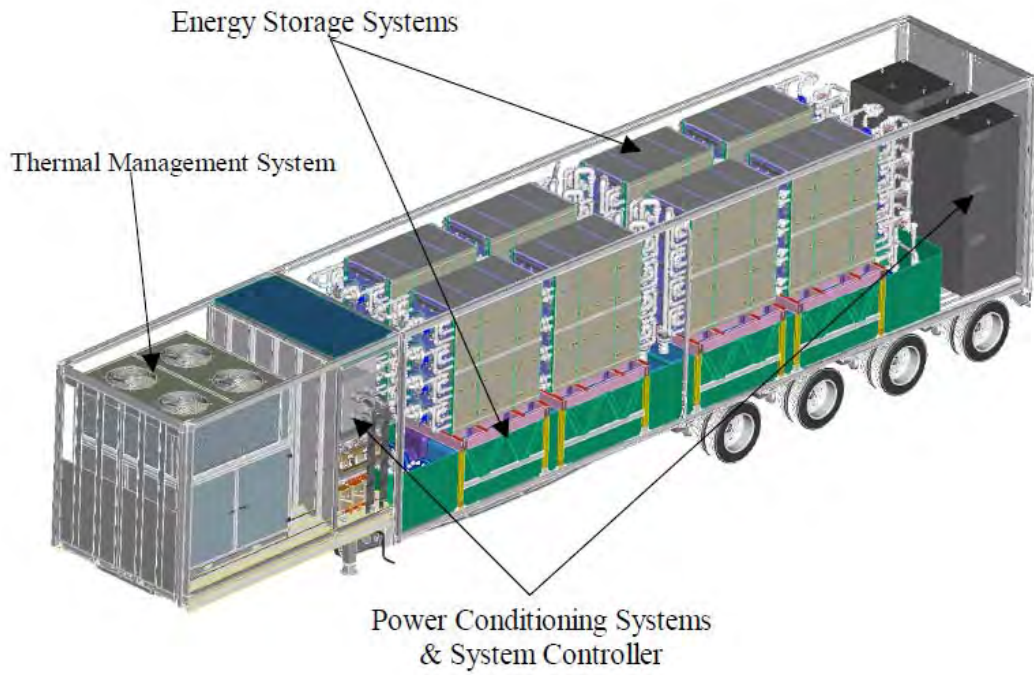

Figure 16 - Premium's TransFlow2000 Section (ZnBr battery)

3.2.2.6 Advanced Lead Acid (Pb-Acid) – Ecoult Energy Storage Solutions (Ecoult)

Lead acid battery technology is tried and proven, and Ecoult, with East Penn, have commercialized UltraBattery, an advanced lead acid battery without the traditional need to maintain a 100% charge. UltraBattery utilizes traditional lead acid reactions with an ultracapacitor.

Ecoult focuses on high power-to-energy applications, primarily involving frequency regulation and power smoothing. However, they have at least one completed and tested project in peak shaving for multiple hours. Ecoult has installed a 3 MW scale demonstration facility, as well as a 3 MW frequency regulation facility on the PJM grid in Pennsylvania. A 3 MW micro-grid application has also been installed that allows an island of 1,500 people to utilize 100% renewable energy. UltraBattery fits best in high power-to-energy ratio applications, such as frequency regulation and renewable energy smoothing. It can achieve efficiencies higher than 90%, and is promoted to be 100% environmentally safe and recyclable. Figure 17 details a 3 MW frequency regulation installation, and Figure 18 shows a typical UberBattery rack.



Figure 17 - 3 MW of frequency regulation at the PJM Interconnection



Figure 18 - UberBattery Energy Block

3.2.3 Summary of Project Data

The following charts summarize the rated capacities of battery storage systems that have been operating or have been contracted to complete installation in the US as provided by the DoE’s Energy Storage Database (see Appendix C for a complete list). Data sets do not include any sales projections or forecasts, and only include data points of projects implemented, or projects breaking ground.

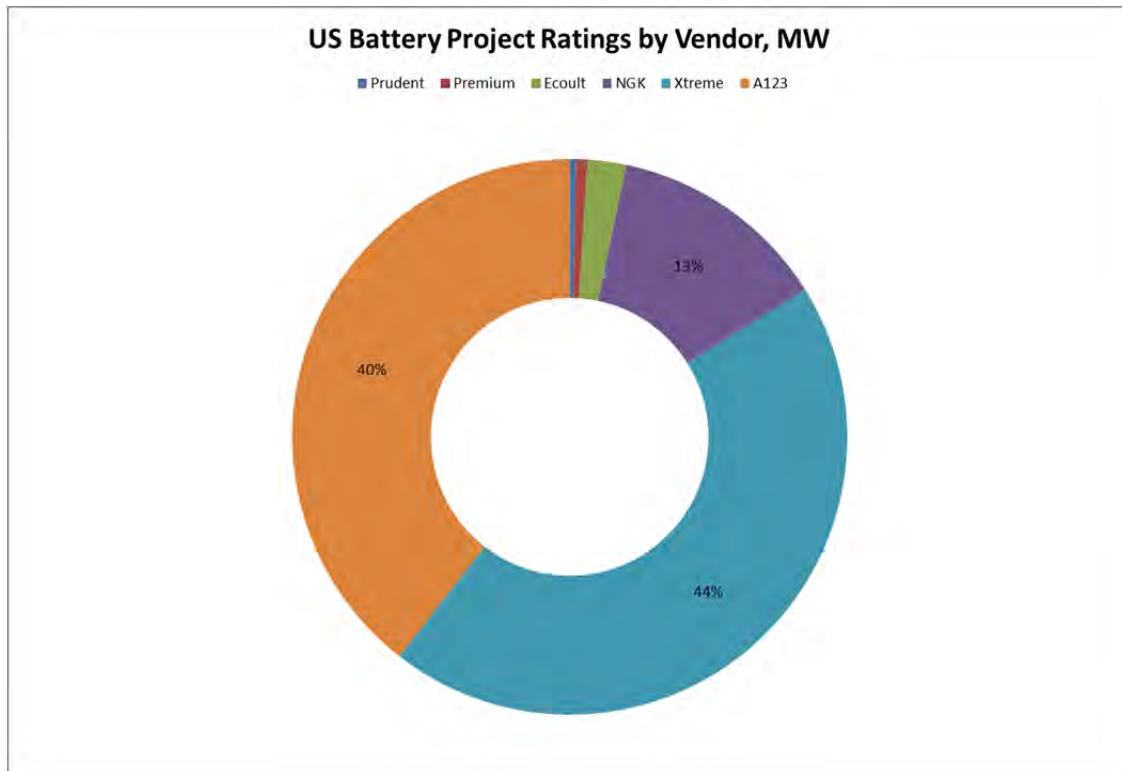

Figure 19 - Rated MW Capacity of US Battery Energy Storage Projects

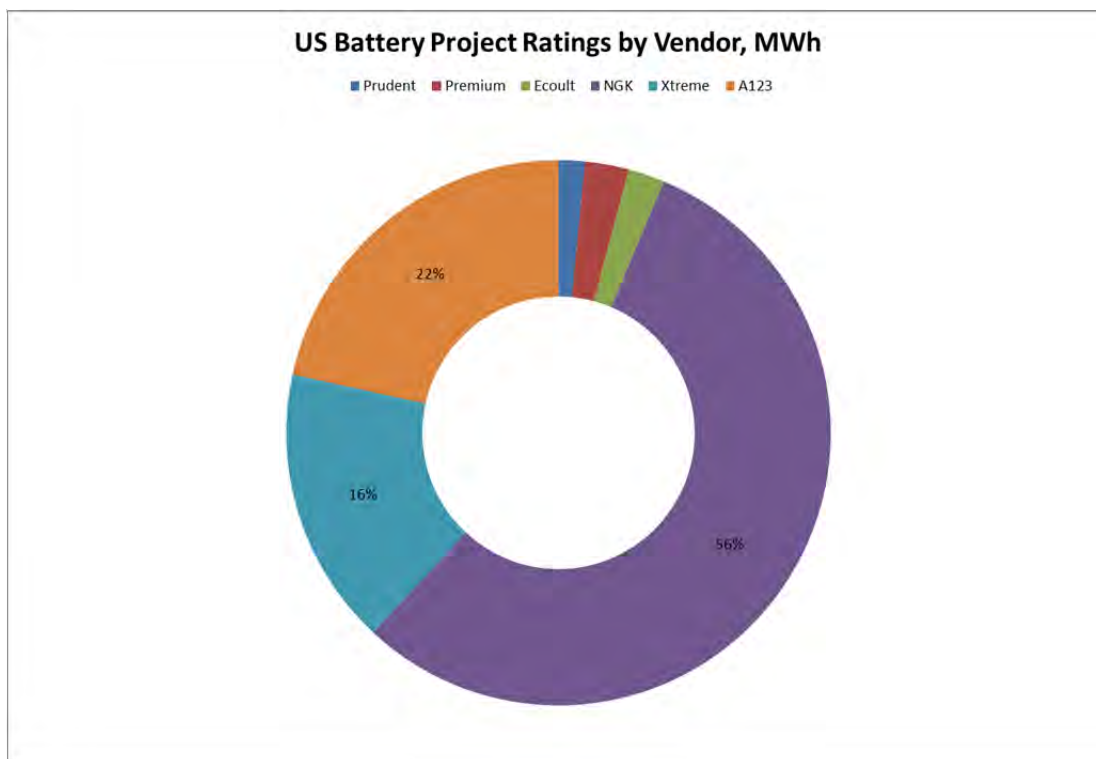

Figure 20 - Rated MWh Capacity of US Battery Energy Storage Projects

Data from the Energy Storage Database provides an approximate indication of the battery industry and should not be construed as an accurate predictor of industry / market behavior. The data collected is not all inclusive of all commercialized manufacturers, does not include all of the projects a given manufacturer has completed, and does not include any emerging technologies that are under final stages of research and development (e.g. American Recovery and Reinvestment Act (ARRA), Advanced Research Projects Agency-Energy (ARPA-E) funding or stealth companies backed by venture capital (VC)s³.

3.2.4 Performance Characteristics

Key performance metrics for battery systems include:

- Roundtrip efficiency – alternating current (AC-to-AC) efficiency of complete battery system, including auxiliary loads
- Energy footprint – amount of physical real estate needed to supply certain amounts of energy in kWh per square feet
- Cycle life – estimated effective useful life of operation the battery in operation
- Storage capacity – sub-hourly or multiple hours of discharge times for systems
- Discharge times – time response of battery system

³ Acronyms:

ARRA = American Reinvestment and Recovery Act of 2009, ARPA-E = Advanced Research Projects Agency – Energy, VC = Venture Capitalists,

- Technology risks – general limitations and concerns of battery systems

Data points collected by manufacturers are summarized in the Technology Matrix in Appendix A.

3.2.4.1 Roundtrip Efficiency

Not all metrics will remain constant throughout a battery system operation and over its life cycle. For almost all technologies, temperature will play a role in performance. Roundtrip efficiencies are also not a constant value and are dependent on the battery State-of-Charge (SOC), temperature and system operations. Losses that are included in roundtrip efficiency estimates include the conversion and storage efficiency of each technology (e.g. voltaic, coulombic, chemical losses), power conversion system losses, transformer losses, and any auxiliary losses due to support equipment (e.g. pumping, cooling, heaters, etc.).

It is also important to distinguish that performance characteristics are generally driven by application requirements – li-ion and dry cell systems have significantly higher roundtrip efficiencies of approximately 90% than does NaS at about 70% or flow batteries at about 60%. In terms of applications, it is the NaS and flow batteries that are generally recognized as providing energy storage in the multiple-hour range (e.g. between 5 to 8 hrs). Roundtrip efficiency is affected by the amount of auxiliary loads needed to support the overall battery system and also by inherent technology inefficiencies. As an example, the flow batteries have chemical inefficiencies because they utilize electrolytes as opposed to solid state cells like li-ion. Flow battery systems also have additional parasitic loads due to the operation of pumps that circulate the electrolyte through the cell stack.

One other contributing factor to roundtrip efficiency includes standby losses that are characterized by self-discharge or by auxiliary loads from support equipment needed to keep battery systems on standby mode. Generally flow batteries (especially during idle time), li-ion and dry cells have the lowest self-discharge rate.

3.2.4.2 Energy Footprint

The energy footprint (square feet per MWh) of battery systems varies considerably, from a few hundred square feet to a few thousand square feet per MWh, depending on technology type and design. Each manufacturer offers standard products, or containerized solutions, as well as custom-designed systems to fit system loads and the physical constraints of the installation (e.g. placing systems in electric utility closet rooms, basements). Solid-state technologies like the li-ion, dry cells, UltraBattery, and NaS will have slightly better energy density than flow battery technology.

HDR advises to use caution when interpreting energy footprint metrics since data points provided by manufacturers range for systems upwards of 1 MW. There will be a fixed amount of real estate needed for every system regardless of MW rating that is dedicated to auxiliary and support equipment (i.e. Power Conversion Systems (PCS), heating, ventilation and air conditioning (HVAC) equipment, transformers), as well as general constraints (i.e. clearances, road access). Premium's TransFlow2000 is currently offered as trailer system and the manufacturer will be offering modular 2.3- and 3-MW plant designs. Depending on the application, footprint may be reduced by constructing a building to house the battery systems rather than the shipping container modules that most manufacturers offer.

It is anticipated that the solid-state battery technology's energy footprint will scale more linearly than that of flow batteries for the reason that energy and power characteristics have been decoupled. Power is a

function of electrode surface area and efficiency whereas energy is a function of usable electrolyte. For a flow battery system, a 1 MW plant operating at 1 hour or at 6 hours will have very different footprints. Differences are due to size of storage tanks, as the following illustrates for Premium's VRB system:

- 1 MW at 1 hour = 3,200 square feet (sq. ft.) at 13 ft. tall (volume = 42,000 cubic ft.)
- 1 MW at 6 hours = 4,800 sq. ft. at 16 ft. tall (volume = 78,000 cubic ft.)

Finally, it is anticipated that flow batteries will offer a greater level of flexibility in system sizing design considering independent characteristics. For example, a 1 MW / 1 MWh system requirement will yield very different energy footprints when comparing a NGK NAS system versus a Prudent VRB system.

3.2.4.3 Plant Life

System plant life is the general expectation of the number of years that the battery plant is expected to function with proper operations and maintenance given throughout its service life. Plant life can be expressed in number of years, or more typical of the battery industry to be expressed and the number of cycles. Generally-speaking, one charge and one discharge make up one cycle. The solid state batteries generally have a life expectancy of 5 to 15 years before replacement, while flow batteries are expected to last 30 years.

System operation, aside from the quality of active maintenance, would also play a significant role in determining plant life – i.e. a battery system operating at reduced Depth-of-Discharge (DOD) will have a longer life. Xtreme PowerCell™ cell curve is used as an example of exponentially-changing number of cycles at various DOD:

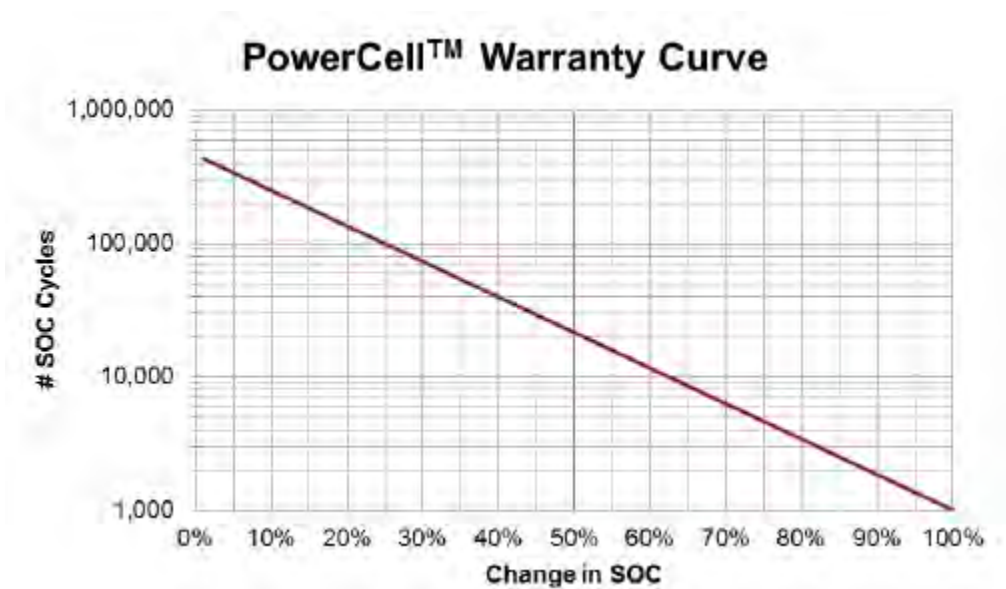

Figure 21 - Typical Battery Life Cycle Curve State of Charge (SOC)

Note that plant life claimed by manufacturers is a compendium of engineering projections, and laboratory testing, while some data points are empirical from field service of battery plants. The flow battery systems claim an indefinite amount of cycles, but have yet to have a battery plant operate for over 20 years – these numbers were instead derived scientifically from tests and research in a laboratory setting. Flow battery

systems do not suffer from solids accumulated from electrochemical reactions as with other battery types thus theoretically having a longer life. UltraBattery's life cycle is highly dependent on application. Their 3 MW frequency regulation project operates 5 to 6 full cycles a day, and is expected to last 5 years before cell replacement is required.

3.2.4.4 Storage Capacity

Storage capacity, rated by the number of hours, varies by technology type and application. Ancillary services focusing on frequency regulation and instantaneous bridging power will have sub-hour requirements whereas bulk energy storage and renewables integration will have multiple-hour requirements. All manufacturers highly recommend that detailed system load modeling and detailed load studies be completed prior to entering design phase to allow each manufacturer to offer the best solutions.

NGK's NAS has a maximum storage capacity of 7.2 hours although standard practice is to limit discharge to 6 hours. Prudent's and Premium's flow battery systems have a maximum capacity of 5 hours for standard product offerings, although it is not uncommon to design systems beyond that storage capacity window. A123's li-ion system is geared for two applications: high power requiring 25 minutes or less storage capacity, or the high energy requiring 4 hours or less storage capacity. Xtreme's dry cell systems are focused on applications with 40 minutes or less storage capacity as well as multiple-hour systems up to 3 hours. Ecoult's UltraBattery systems exhibited case studies with as little as a few seconds of discharge time up to 2-3 hours of peak shaving.

3.2.4.5 Discharge Time

Discharge time is a standard measure for a battery energy storage system to reach full output from a state of zero output. This may be a critical consideration for time-sensitive, quick-acting, applications like frequency regulation. The fastest discharge time presented is 7 milliseconds for the ZnBr system followed by 20 milliseconds for the li-ion system, and finally 40 milliseconds for the VRB and UltraBattery systems. Li-ion systems are generally not suited for quick discharges because it results in generation of immense amount of heat, greatly reducing their efficiency through parasitic loads.

3.2.5 System Details and Requirements

All battery systems use inverters to convert between DC and AC currents. Power electronics (e.g. chargers, transducers) are used to monitor battery cell performance and control overall system performance in real-time. All of these components, and other ancillary control or electronic systems, make up the Power Conversion System (PCS). All manufacturers currently offer PCS design services in-house, and source manufacturing to other reputed components manufacturers like Dynapower, Parker Hannifin, ABB, S&C, GE, Satcon etc.

All battery systems require auxiliary ventilation, road access and some form of telecommunication infrastructure (e.g. radio, telephone line or Local Area Network (LAN) infrastructure). Prudent's VRB will require a building structure to house the battery system and associated support equipment. Premium's ZnBr system is currently marketed as a self-contained trailer system, but it is anticipated that their modular MW-block solutions will also require housing structures. Many manufacturers offer either modular container housing or the ability to be built into an existing or planned structure.

NGK's NAS battery system will require an auxiliary heating source to maintain operating temperatures at 300 degrees Celsius, or 572 degrees Fahrenheit, when the system has idled for a given period of time. The temperature tolerance could not be ascertained. Auxiliary heating is required to keep the battery chemical in a molten state to avoid the phase change of NaS from liquid to solid. Generally, a 7.2-kW electric resistance heater is used to keep cells within required temperature limits only when the battery system is idle. At a system level, parasitic loads can be characterized as 50 kW per 1 MW capacity for its Storage Management System (SMS) and 144 kW (heating) or 56 kW (temperature maintenance mode) per 1 MW capacity for its block heater.

Conversely, A123's li-ion system will require auxiliary cooling for its system, but only during operation, as long as the ambient conditions are between 20 and 30 °C. Auxiliary cooling is needed because of inherent energy extraction inefficiencies of an electrochemical cell. A battery plant is typically accompanied by a chiller plant. Flow battery systems will generally require some form of cooling for its system. Premium's TransFlow2000 trailer system comes equipped with an integrated chiller. Depending on climate zones, Prudent's VRB plants may require an accompanying chiller plant under warm conditions.

In addition, flow battery systems will have pumps to move electrolytes into each compartment. Prudent's electrolyte supply pumps are controlled by a Variable Frequency Drive (VFD) and power draw cycles between 2.5 kW (standby) and 5 kW (full load operation).

All data points presented by manufacturers on system requirements are summarized in the Technology Matrix in Appendix A.

3.2.6 Technology Risks

Each battery technology shares a certain amount of risk associated with installation and operation. NGK's NAS systems require a heating source when running idle, and a recent fire incident prompted NGK to upgrade battery internals and fire suppression systems accordingly. Its ceramic-aluminum bonds within the beta alumina cell are susceptible to corrosion gradually over a period of 15 years. Leakage of molten sulfur is unlikely, but has happened, and fires are now prevented by additional fuses, insulation boards within the units, and anti-fire boards between stacked modules. Xtreme's battery system is generally limited to 50% depth of discharge, meaning that the battery's charge may not drop below 50%. Prudent's VRB system has a relatively larger footprint than other systems and may require additional space to accommodate a chiller plant depending on site climate. Both flow battery systems share the same life-limiting component in the form of a plastic substrate that lies between the anode and cathode, effectively creating two compartments. Premium's plastic substrate is made out of a high porosity polyethylene that can degrade over time. Power electronics failure was a common concern among the manufacturers.

3.2.7 Capital, Operating and Maintenance Cost Data

Capital costs were collected at the system level to better reflect actual costs associated with each battery system. Based on vendor information, all-in costs for a typical 10 MWh installation at a 6:1 MWh to MW ratio are estimated to be between \$17 and \$20 million. Subsequent cost numbers do not reflect any site civil development costs and do not include any permitting or planning study costs. Because flow batteries have greater design flexibility in terms of power and energy, cost data is presented on a per kWh basis. System costs, common units either in \$ per kW or \$ per kWh, should only be compared when examining

battery systems for a particular application. For example, A123's li-ion battery systems are quoted for High Power (15 minutes) and High Energy (up to 4 hours).

Throughout its service life, it is anticipated that every battery plant will undergo standard and routine maintenance including general housekeeping, active and preventive maintenance on predominantly electrical equipment (e.g. infrared scanning, visual inspection, replacing capacitors, fans, thermistors). Systems with mechanical equipment such as auxiliary HVAC equipment may require more maintenance (e.g. replacing air filters, pressure transducers, valves).

Battery cells/stacks will need replacement throughout the effective useful life of the battery plant. All manufacturers currently offer standard product warranties spanning no more than 2 years with an option for extension for a certain period of time, or on an annual basis. Xtreme's dry cells have longer standard warranty than the rest at 5 years, although balance of plant is warranted for 2 years.

Component change-out or system repair under warranty is generally carried out by the manufacturer or in some cases, a qualified field service representative. The forced outage rate of all battery systems generally ranges from 0.3% to 3%. Although Prudent and Xtreme currently do not have in-house, contracted, maintenance service capabilities, they do offer comprehensive training services to ensure system owners and operations teams gains an thorough of system performance.

Operating costs can be further defined as follows:

Fixed O&M: Fixed operations and maintenance costs take into account plant operating and maintenance staff as well as costs associated with facility operations such as building and site maintenance, insurances, and property taxes. Also included are general housekeeping, routine inspections of equipment performance and general maintenance of systems. For battery systems with auxiliary cooling equipment (i.e. chiller plants), additional maintenance costs over other battery types will be incurred. General O&M costs will also include spare parts, and component or equipment change-out (i.e. inverter fan filters once they get dusty). For all battery systems, fixed O&M cost will also include the cost of remote monitoring (i.e. cost of telecommunications carrier, secured web hosting / monitoring).

Variable O&M: Variable cost includes the cost of corrective maintenance and other costs that are proportional to unit output. This will likely be, but not limited to, the diagnosing, investigation and testing of components, and the subsequent costs for corrective action.

All cost and maintenance data available from the manufacturers are summarized in the Technology Matrix in Appendix A.

3.3 Compressed Air Energy Storage

3.3.1 CAES Technology Description

Compressed Air Energy Storage consists of a series of motor driven compressors capable of filling a storage cavern with air during off peak, low load hours. At high load, on peak hours the stored compressed air is delivered to a series of combustion turbines which are fired with natural gas for power generation. Utilizing pre-compressed air removes the need for a compressor on the combustion turbine, allowing the turbine to operate at high efficiency during peak load periods.

Compressed air energy storage is the least implemented and developed of the stored energy technologies. Only two plants are currently in operation, including Alabama Electric Cooperative's (AEC) McIntosh

plant (rated at 110 MW) which began operation in 1991. The McIntosh plant was mostly funded by AEC, but the project was partially subsidized by EPRI and other organizations. Dresser Rand supplied the compressors and recuperators and is the only known supplier to offer a compressor for the application with a reliable track record. The other plant in operation, the Huntorf facility, is located in Huntorf, Germany which utilizes an Alstom turbine. The equipment utilized in CAES plants, which includes compressors and gas turbines, is well proven technology used in other mature systems and applications. Thus, the technology is considered commercially available, but the complete CAES system lacks the maturity of some of the other energy storage options as a result of the very limited number of installations in operation.

Two primary types of CAES plants have been implemented or are being reviewed for commercial operation: (a) diabatic and (b) adiabatic. In diabatic CAES, the heat resulting from compressing the air is wasted in the process. The air must be reheated prior to expansion. Adiabatic CAES stores the heat of compressions in a solid (concrete, stone) or a liquid (oil, molten salt) form that is reused when the air is expanded. Due to the conservation of heat, adiabatic storage is expected to achieve efficiencies of 70%. Both the McIntosh and Huntorf are diabatic CAES plants. One adiabatic plant is currently under development in Germany.

Other CAES plants have been proposed but, as of yet, have not moved forward beyond conceptual design. These proposed projects include the Western Energy Hub Project, the Norton Energy Storage (NES) project, the PG&E Kern County CAES plant, and the ADELE CAES plant in Stassfurt, Germany.

The Western Energy Hub project, promoted by Magnum Energy, LLC (Magnum), is probably the most advanced CAES project under development in the U.S. The salt dome geology has been well characterized, as well as land acquisition and local and state permitting underway.

The first phase of the Magnum project is for natural gas liquids (propane and butane) storage which broke ground in April 2013. This initial phase is expected in service in 2014, and will involve leaching out two caverns for propane and butane storage.

The second phase of the project under development is construction of four additional solution-mined underground storage caverns capable of storing 54 billion cubic feet of natural gas. On March 17, 2011, the Federal Energy Regulatory Commission (FERC) issued an order granting Magnum a certificate of public convenience and necessity under section 7(c) of the Natural Gas Act (NGA) to construct and operate a natural gas storage facility and header pipeline. On February 22, 2011 the Bureau of Land Management (BLM) issued a Decision Record granting Magnum a Right of Way Grant for the header pipeline. Magnum will construct and operate a 61.5 mile header pipeline from its storage facility near Delta to Goshen, Utah. Magnum has also been granted all the necessary permits for construction and operation of the gas storage facility from the State of Utah.

The final phase of the Western Energy Hub project is CAES, in conjunction with a combined-cycle power generation project. The CAES will utilize additional solution-mined caverns to store compressed air. Off-peak renewable generation will be used to inject air into the caverns which will be released during periods of peak power demand. The compressed air will be delivered to a combustion turbine, eliminating the need for a compressor on the combustion turbine, allowing the turbine to operate at high output and efficiency during peak load periods. Magnum plans a total of 1,200 MW of capacity spread across four 300 MW modules, with two days of compressed air at full load. Magnum anticipates an in-service date of around 2017-2018.

The NES Project has been purchased by First Energy. The proposed project was to have an initial capacity of 270 MW, with a potential expanded capacity of 2700 MW project. The project site is located above a 600-acre underground cavern that was formerly operated as a limestone mine in Norton, Ohio. The geological conditions of the site have been assessed by Hydrodynamics Group and Sandia National Laboratories, and the integrity of the mine has been confirmed as a stable vessel for compressed air storage. In December 2012, First Energy suspended construction on the project due to unfavorable economic conditions including low cost of power prices and insufficient demand. As of September 2013, the Ohio Power Siting Board invalidated the certificate at this site.

PG&E has been awarded a \$25M grant from the Department of Energy (DOE) to research and develop a CAES plant. The California Public Utility Commission (CPUC) has matched the grant and supplied an additional \$25M; the California Energy Commission has supplied an additional \$1M of support. The proposed project is a 300 MW plant in Kern County, CA. The first phase is reservoir feasibility study that is scheduled to be completed in Q4 2015. If the project proceeds, the plant is estimated to be operational in 2020. It has not been stated whether the proposed plant will be diabatic or adiabatic and is likely subject to the outcome of the feasibility study.

The ADELE project is an adiabatic CAES plant in Stassfurt, Germany. The project is planned to have a storage capacity of 360 MWh, with a total output of 90 MW and projected efficiency of 70%. The project is part of the Federal Government's Energy Storage Initiative and is funded by the German Federal Ministry of Economics and Technology. The initial development phase is funded with \$17M (12M Euro) and was expected to be completed by 2013. The total project was expected to have duration of 3.5 years and a cost of \$56M (40M Euro). The initial project development is now slated for completion in 2016; the reason for the delay has not been disclosed and the project is still progressing.

3.3.1.1 Technology Risks

CAES has performed very well at the AEC McIntosh plant and therefore little risk is perceived from a technical standpoint provided the proper equipment suppliers are utilized and design factors are considered. Dresser Rand provided the majority of the equipment for the AEC McIntosh plant. The construction of the Huntorf facility in Germany began construction in 1976, a time when gas turbines were not commercially implemented so the Huntorf turbine is a modified steam turbine. Alstom does currently offer a gas turbine for compressed air applications, but none are currently in operation. As such, there is limited potential to competitively bid the major equipment without exposing risk for utilizing first-of-a-kind equipment from an unproven supplier. Another significant risk involves the ability to identify an energy storage geological formation with integrity and accessibility.

Adiabatic designs are under development and introduce new risks into the design of a CAES plant. There are additional heat-storage devices and components in the system that will increase the design complexity of the system. The compressed air is expected to have temperatures in excess of 1,100F, which will require alloyed and/or ceramic materials. There is still uncertainty regarding materials of construction for the compressors and heat storage that would optimize the design. GE Oil & Gas is currently developing an air compressor and air-turbine for use in the ADELE project. A partnership between German companies Zublin and Ooms-Ittner-Hof are developing the heat storage capabilities.

3.3.2 Performance Characteristics

During discharge of the compressed air, the AEC McIntosh plant achieves a fuel heat rate of roughly 4,550 Btu/kWh (HHV). Dresser Rand has made improvements to their CAES equipment offering since the commissioning of the McIntosh plant. These improvements could result in a heat rate of 4,300 Btu/kWh (HHV) but have not been proven on a commercial scale application that is in operation. The primary function of the McIntosh plant is for peak shaving.

The ADELE plant will have similar operating characteristics to McIntosh and Huntorf. The compressors are being designed for compression of up to 1,450 psia; however, the planned storage pressure is 1,015 psia. The total storage capacity is expected to be 360 MWh with an electrical output of 90MW; equivalent to 4 hours of energy storage at full utilization. The big improvement in the adiabatic plant is the round-trip efficiency. The ADELE plant is projected to have a total efficiency in excess of 70%; compared to AEC McIntosh (54%) and Huntorf (42%). The efficiency gains are a result of capturing the heat in the adiabatic process.

3.3.2.1 Site Elevation

Site elevation does impact the performance characteristics of a diabatic CAES plant. In simple cycle combustion turbine plants, the turbine output decreases with increased elevation as a result of the lower air density. Since gas turbines are standardized designs, the compressor and turbine sections are not modified or designed for specific site applications. The compressor size and compression ratio is therefore fixed and the flow rate of air through the compressor decreases as ambient air pressure decreases (i.e. elevation increases). The Compression ratio is the ratio between the discharged air pressure and the inlet air pressure to the compressor. At higher elevations, the compressed air on the turbine side enters the inlet of the gas turbine at a lower inlet pressure as a result of the fixed compression ratio. In turn, less fuel is combusted due to lower air flow rates. Thus, power generation decreases by as much as 20 percent when comparing a combustion turbine at sea level and one at 6,000 feet in elevation.

The same fundamentals apply to CAES technology, except that there is more flexibility in the compressor design which can be decoupled from the gas turbine if desired. This allows a compressor to be designed to achieve a higher compression ratio for higher elevation applications, although the power required to drive the compressor will also increase. On the gas turbine side, the power output can actually increase slightly at higher elevations as a result of a lower turbine exhaust pressure, assuming the inlet pressure is the same as at lower elevations.

The CAES performance is identified in the Technology Summary Matrix at 6,000 feet elevation assuming a plant located in the PacifiCorp service area.

3.3.2.2 Reliability/Availability

Varying sources over varying time periods report that the AEC McIntosh plant offers availability from 86 to 95 percent. At this facility, every air compressor is mounted to a single shaft that is coupled to a combined motor/generator unit via a clutch. Likewise, every turbine is also mounted to a single shaft that is coupled to a combined motor/generator unit via a clutch. Depending on the operational mode, compression or power generation, the motor/generator unit is either coupled to the air compressors or turbines but not both. AEC not only recommends separating the motor for compression and generator for

electrical production, but also recommends separating each air compressor and turbine to alleviate maintenance complexities and to increase reliability.

During the design of a CAES plant, careful consideration regarding materials of construction must be undertaken such that materials do not fail or need replacement in an unexpected time frame due to corrosion and abrasive erosion. For example, if a salt cavern is utilized, the turbine manufacturers' specifications regarding the quantity of salts in the incoming air must be considered. Additionally, the Huntorf design offers dual storage caverns which have enabled the plant to achieve approximately 90 percent plant availability. The Huntorf plant experienced corrosion problems with the storage cavern wells; thus, having two storage caverns enabled operation of the plant while one storage cavern was inoperable due to a well head repair.

Due to the high temperatures (>1,100F) of adiabatic plant designs, specialized materials of construction could result in extended lead times for the fabrication of equipment. This would also result in increased cost of the plant to keep critical spares on-site.

3.3.2.3 Start Times

Compressed air energy storage requires initial electrical energy input for air compression and utilizes natural gas for combustion in the turbine. The McIntosh plant offers fast startup times of approximately 9 minutes for an emergency startup and 12 minutes under normal conditions. As a comparison, simple cycle peaking plants consisting of gas turbines also typically require 10 minutes for normal startup.

The Huntorf CAES plant has been designed as a fast-start and stand-by plant; it can be started and run at full-load in 6 minutes.

3.3.2.4 Emission Profiles/Rates

It is expected that CAES will have emissions similar to that of a simple cycle combustion turbine, except reduced by approximately 60 to 70 percent due to reduced natural gas consumption on a per kWh basis.

The diabatic plants, such as AEC McIntosh and Huntorf, require additional natural gas firing for the combustion turbine and for reheating the compressed air. Adiabatic plants, such as ADELE, will not require supplemental firing of natural gas for heating the air, and will have an overall lower plant emissions.

3.3.2.5 Air Quality Control System Design

Dry low mono-nitrogen oxides (NO_x) combustion technology can be utilized for control of NO_x emissions on the combustion turbine for CAES. If NO_x emissions are pushed lower such that dry low NO_x combustion technology is insufficient, CAES technology permits use of a selective catalytic reduction (SCR) module, but in this case it would likely be integrated into the recuperator design, permitting close control of the catalyst temperature.

3.3.3 Geological Considerations

There are three types of geological formations generally considered for storing compressed air: salt domes, aquifers, and rock caverns. These formations can then be classified as either constant volume or constant pressure caverns. Constant pressure caverns utilize surface water reservoirs to maintain a constant cavern pressure as the compressed air displaces the water when it is injected into the cavern.

Constant volume caverns have a fixed volume and therefore the air pressure in the cavern decreases as compressed air is released from the cavern. Figure 22 depicts the aforementioned geological formations generally considered for compressed air energy storage.

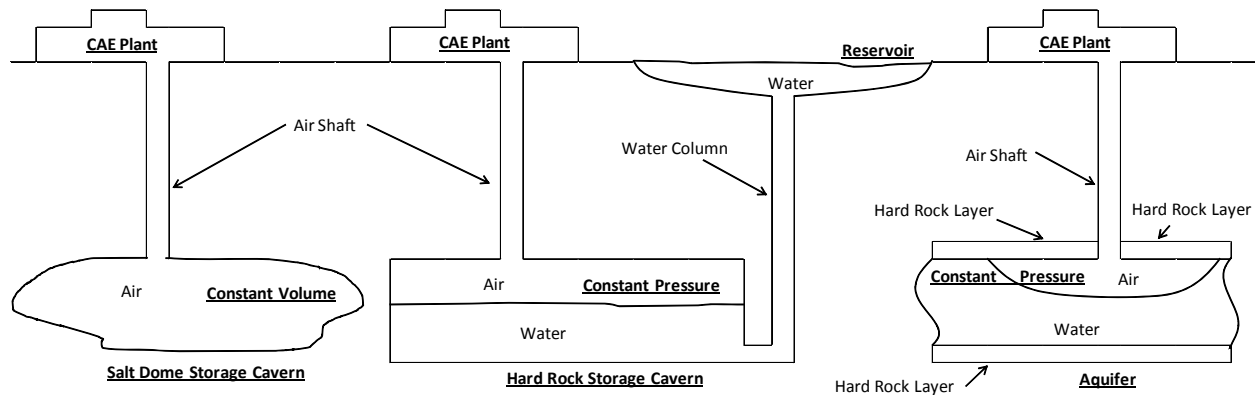

Figure 22 - CAES Geological Formations

Figure 23 depicts an overall map of the continental United States with areas that contain potential geological formations favorable for CAES.

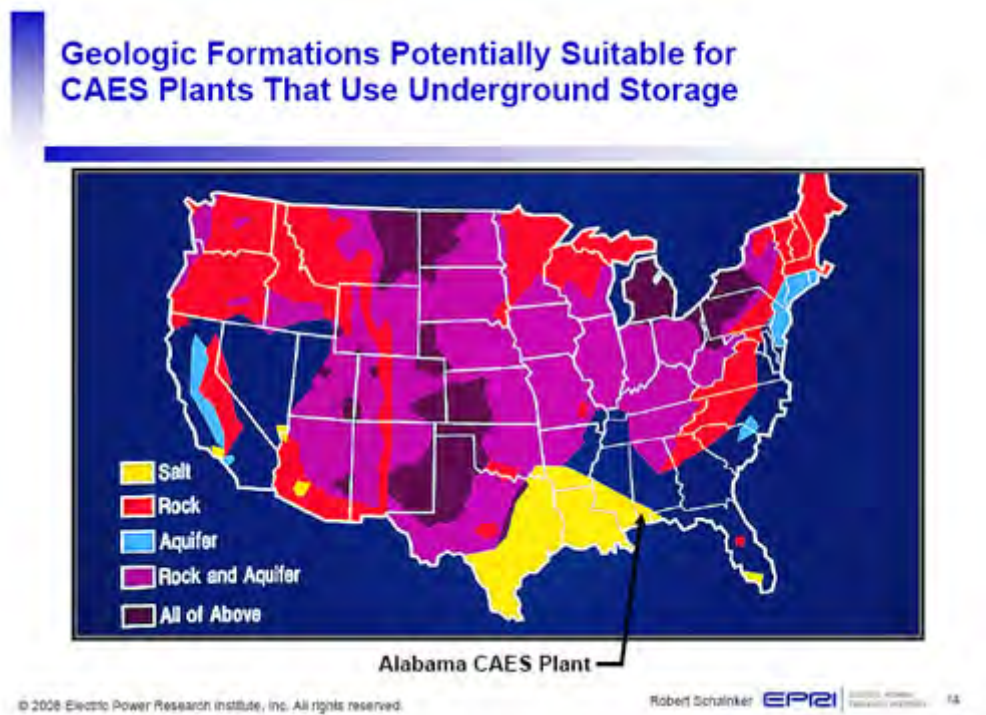

Figure 23 - Potential Geological Formations Favorable for CAES

3.3.4 Capital, Operating, and Maintenance Cost Data

The project schedule for a CAES plant is highly dependent on the manufacturer’s lead times for equipment. For the most part, a project should be able to be implemented in a time frame similar to that of a combined cycle combustion turbine plant, if a recuperator is to be implemented, provided the

compressed air storage geological formation is available. If a project forgoes a recuperator, the project schedule can be reduced by four to six months. If a salt cavern must be drilled and solution mined before implementation, this time frame becomes dependent upon the process used to permit and prepare the cavern. Solution mining the cavern may take up to 18 to 24 months, but can be done in conjunction with construction of the CAES plant.

Based on information gathered from similar projects in development, expected project duration is summarized in Table 6.

Table 6 - CAES Typical Project Schedule

Task	Duration
Test well	10 mo.
Preliminary design	3 mo.
Permitting	12 mo.
Final design	6 mo.
Construction	24 mo.
Sum of Tasks	55 mo.

CAES options can vary considerably depending upon the specific project. The power island for a CAES option is typically small and similar in size to that of a combined cycle plant. Construction of the underground storage reservoir is a significant contributor to the cost of CAES. Aquifers and depleted gas reservoirs are the least expensive storage formations since mining is not necessary. Salt caverns are the most expensive storage formations since solution mining is necessary before storage. Storage formations vary in depth but most formations that can currently be utilized range between 2,500 ft to 6,000 ft below the earth's surface. Storage formations vary naturally in size but storage caverns can be appropriately mined to achieve a specific storage capacity.

3.3.4.1 Capital Costs

The McIntosh project was commissioned in 1991 and at that time cost \$65 million. Since the McIntosh plant offers 110 MW of net power, the plant cost was \$590/kW.

The Iowa Stored Energy Park (ISEP) was originally estimated at approximately \$400 million for a plant size of 270 MW. A detailed Sandia report on the lessons learned from the ISEP CAES plant is available in Appendix D.

Projected cost information has not been made available for the PG&E Kern County and ADELE CAES plants.

Due to the limited number of CAES projects completed and vague task descriptions often associated with project costs as well as external funding that was provided for McIntosh, HDR estimates that CAES project capital costs would be in the range of \$1,600/kW to \$2,200/kW for a 300 to 500 MW diabatic CAES plant, including ten hours of solution-mined storage capacity. The technology for an adiabatic plant has not been made public and a capital cost cannot be accurately projected at this time; the total capital cost will be greater than a diabatic plant. HDR assumes project capital costs to include project direct costs associated with equipment procurement, installation labor, and commodity procurement as

well as construction management, project management, engineering, and other project and owner indirect costs. This estimate does not include storage cavern cost. Values are presented in 2014 dollars.

3.3.4.2 Operating Costs

Fixed O&M: Fixed operations and maintenance costs take into account plant operating and maintenance staff as well as costs associated with facility operations such as building and site maintenance, insurances, and property taxes. Also included are the fixed portion of major parts and maintenance costs, spare parts and outsourced labor to perform major maintenance on the installed equipment. The estimated fixed O&M costs for the ISEP CAES plant would be \$18.78/kW in 2014 USD. Fixed O&M costs are expected to be similar for a diabatic CAES facility. An adiabatic plant would have greater fixed O&M costs due to increased complexity in the system design.

Variable O&M: The non-fuel related variable O&M costs for the ISEP CAES plant is estimated to be \$2.28/MWh in 2014 USD. Variable O&M costs are expected to be similar for a diabatic CAES facility. Additional variable O&M for fuel and electric costs should be considered when evaluating a diabatic plant. Fuel and electric costs should be considered based on existing gas and power purchase agreements or local market pricing.

3.4 Flywheels

3.4.1 Flywheel Technology Description

Flywheels are electromechanical energy storage devices that operate on the principle of converting energy between kinetic and electrical states. A massive rotating cylinder, usually spinning at very high speeds, connected to a motor stores usable energy in the form of kinetic energy. The energy conversion from kinetic to electric and vice versa is achieved through a variable frequency motor or drive. The motor accelerates the flywheel to higher velocities to store energy, and subsequently slows the flywheel down while drawing electrical energy. Flywheels also typically operate in a low vacuum environment to reduce inefficiencies. Superconductive magnetic bearings may also be used to further reduce inefficiencies.

Generally, flywheels are used for short durations to supply backup power in a power outage event, or for regulating voltage and frequency.

3.4.2 Manufacturers

A quick market survey of the energy storage industry reveals that there is only one flywheel technology manufacturer that has achieved utility market commercialization: Beacon Power Corporation with their Generation 4 Flywheels.

Newer technology flywheel systems utilize a carbon fiber, composite flywheel that spins between 8,000 and 16,000 revolutions per minute (RPM) in an extremely low friction environment, near vacuum, using hybrid magnetic bearings. Flywheels store energy through its mass and velocity.

Flywheels are recognized for potentially long service life, fast power response and short recharge times. They also tend to have relatively high turnaround efficiency on the order of 85%. This energy storage technology is classified as commercial in regards to utility applications.

Beacon offers its flywheel technology and balance of system plants as the Smart Energy 25 product. In 2011, the company entered bankruptcy protection. In 2012, Beacon's assets, including the 20 MW

Stephentown NY storage plant (Figure 24), were bought by a private equity firm, Rockland Capital. Beacon offers turn-key solutions in the US and Europe, and also provides in-house operating and maintenance services.



Figure 24 - Flywheel Plant Stephentown, New York

3.4.3 Performance Characteristics

A few performance characteristics of flywheels include: low lifetime maintenance, operation can typically be of high number of cycles, 20-year effective useful life and since kinetic energy is used as the storage medium, there are no exotic or hazardous chemicals present.

Roundtrip AC-to-AC efficiency of the system is in the order of 85% with primary parasitic loads being the Power Conversion System (PCS) and internal cooling system, among the mechanical and friction losses of the system. Beacon estimates the energy losses through a flywheel plant to be in the order of 7% or less of energy throughput of the plant. Primary losses are intrinsic, and include friction (between rotor and environment) and energy conversion losses (generator losses including windings, copper, induction).

Energy footprint for flywheels is generally large and comparable to that of pumped hydropower. Plant life is expected to be 125,000 cycles (at 100% DOD) over a period of 25 years with no change in energy storage capacity resulting in a high amount of energy throughput throughout its effective useful life.

Flywheel's largest limitations are its large energy footprint and its relatively short energy storage duration of 15 minutes or less per system. System response times are less than 4 seconds and ramp up/down rates can be 5 MW per second. This makes it an ideal candidate to serve in the frequency regulation services to the grid operator while maintaining reliability. According to Beacon, one technology risk associated with flywheel systems lie in its power electronics modules which have statistically failed once every 150,000

hours of operations. There is also risk associated with catastrophic flywheel failure. Two flywheels failed at Stephentown soon after installation.

3.4.4 Manufacturer Pros and Cons

Beacon is considered in the industry as a pioneer in developing utility scale flywheel energy storage systems. To date, the company has five projects in the U.S. with a nameplate capacity of 26 MW. A significant portion of Beacon's services are focused on regulation services. Another Beacon flywheel energy storage project (20 MW) is currently under construction in Hazle Township, PA. Additionally, Beacon is studying the implication of integrating a 200-MW flywheel energy storage system at a wind farm in Ireland.

3.4.5 Capital, Operating and Maintenance Cost Data

Capital and operating cost data points from Beacon Power Corporation remains proprietary and cannot be disclosed unless a Non-Disclosure Agreement (NDA) has been signed and executed. However, data points from publicly-available documents suggest that the 20 MW Beacon flywheel plant is estimated to cost \$50 million. This yields \$2,400 per installed kW.

Throughout its service life, it is anticipated that the flywheel system will require standard and routine maintenance including general housekeeping and preventive maintenance on its electrical equipment. The flywheel plant will require telecommunications infrastructure (e.g. radio, telephone or local area network (LAN)) to allow for remote monitoring.

3.5 Liquid Air Energy Storage (LAES)

3.5.1 LAES Technology Description

LAES uses off-peak electricity to cool air from the atmosphere to minus 195 °C, the point at which air liquefies. The liquid air, which takes up one-thousandth of the volume of the gas, can be kept for a long time in a large vacuum flask at atmospheric pressure. At times of high demand for electricity, the liquid air is pumped at high pressure into a heat exchanger, which acts as a boiler. Either ambient air or low grade waste heat is used to heat the liquid and turn it back into a gas. The massive increase in volume and pressure from this is used to drive a turbine to generate electricity.

3.5.2 LAES Performance

In isolation the process is only 25% efficient, but this can be increased (to around 50%) when used with a low-grade cold store, such as a large gravel bed, to capture the cold generated by evaporating the cryogen. The cold is re-used during the next refrigeration cycle. Efficiency is further increased when used in conjunction with a power plant or other source of low-grade heat that would otherwise be lost to the atmosphere.

A 300 kW, 2.5MWh storage capacity pilot cryogenic energy system developed by researchers at the University of Leeds and Highview Power Storage, that uses liquid air (with the CO₂ and water removed as they would turn solid at the storage temperature) as the energy store, and low-grade waste heat to boost the thermal re-expansion of the air, has been operating at a biomass power station in Slough, UK, since 2010. The efficiency is less than 15% for this pilot plant.

3.6 Supercapacitors

3.6.1 Supercapacitor Technology Description

Supercapacitors bridge the gap between conventional capacitors and rechargeable batteries. They have energy densities that are approximately 10% of conventional batteries, while their power density is generally 10 to 100 times greater. This results in much shorter charge/discharge cycles than batteries. Additionally, they will tolerate many more charge and discharge cycles than batteries.

Supercapacitors have advantages in applications where a large amount of power is needed for a relatively short time, where a very high number of charge/discharge cycles or a longer lifetime is required. Typical applications range from milliamp currents or milliwatts of power for up to a few minutes to several amps current or several hundred kilowatts power for much shorter periods. Supercapacitors do not support AC applications.

3.6.2 Supercapacitor Performance

Supercapacitors support a broad spectrum of applications, including:

- Stabilizing power supply in hand-held devices with fluctuating loads.
- Providing backup or emergency shutdown power to low-power equipment such as RAM, SRAM, micro-controllers and PC Cards.
- Power for cars, buses, trains, cranes and elevators, including energy recovery from braking, short-term energy storage and burst-mode power delivery.
- Providing uninterruptible power supplies where supercapacitors have replaced much larger banks of electrolytic capacitors.
- Providing backup power for actuators in wind turbine pitch systems, so that blade pitch can be adjusted even if the main supply fails.
- Stabilizing within milliseconds grid voltage and frequency, balancing supply and demand of power and managing real or reactive power.

3.7 Superconducting Magnet Energy Storage (SMES)

3.7.1 SMES Technology Description

Superconducting Magnetic Energy Storage (SMES) systems store energy in the magnetic field created by the flow of direct current in a superconducting coil which has been cryogenically cooled to a temperature below its superconducting critical temperature.

A typical SMES system includes three parts: superconducting coil, power conditioning system and cryogenically cooled refrigerator. Once the superconducting coil is charged, the current will not decay and the magnetic energy can be stored indefinitely.

The stored energy can be released back to the network by discharging the coil. The power conditioning system uses an inverter/rectifier to transform alternating current (AC) power to direct current or convert DC back to AC power. The inverter/rectifier accounts for about 2–3% energy loss in each direction.

3.7.2 SMES Performance

SMES loses the least amount of electricity in the energy storage process compared to other methods of storing energy. SMES systems are highly efficient; the round-trip efficiency is greater than 95%.

Due to the energy requirements of refrigeration and the high cost of superconducting wire, SMES is currently used for short duration energy storage. Therefore, SMES is most commonly devoted to improving power quality. The most important advantage of SMES is that the time delay during charge and discharge is quite short. Power is available almost instantaneously and very high power output can be provided for a brief period of time.

There are several small SMES units available for commercial use and several larger test bed projects. Several 1 MWh units are used for power quality control in installations around the world, especially to provide power quality at manufacturing plants requiring ultra-clean power, such as microchip fabrication facilities.

These facilities have also been used to provide grid stability in distribution systems. In northern Wisconsin, a string of distributed SMES units were deployed to enhance stability of a transmission loop. The transmission line is subject to large, sudden load changes due to the operation of a paper mill, with the potential for uncontrolled fluctuations and voltage collapse.

4 COMPARISON OF STORAGE TECHNOLOGIES

HDR has performed an initial comparison of the energy storage technologies discussed in this document. The full comparison can be seen in the energy storage matrix in Appendix A. Table 7 below lists some of the key criteria that were compared when considering these technologies.

Table 7 - Energy Storage Comparison Summary

	Pumped Storage Hydro (Three sites)	Batteries	Compressed Air Energy Storage
Range of power capacity (MW) for a specific site	600 – 1,500	1-32	100+
Range of energy capacity (MWh)	5,280 – 16,500	Variable depending on DOD	800+
Range of capital cost (\$ per kW)	\$1,700-\$2,500	\$800-\$4,000	\$2,000-\$2,300
Year of first installation	1929	1995 (sodium sulfur)	1978

The following sections provide comments on the overall commercial development of the technology, the applications suited to each technology, space requirements for each technology, performance characteristics, project timelines, and capital, operating and maintenance costs.

4.1 Technology Development

Figure 25 below by the California Energy Storage Association (CESA) illustrates the installed capacity of various energy storage technologies worldwide. Pumped storage is by far the most mature and widely used energy storage technology used not only in the US, but worldwide. In the U.S., pumped storage accounts for over 20,000 MW of capacity. By comparison, there is only one existing CAES facility in the U.S., with a capacity of 110 MW. Sodium-sulfur (Na-S) batteries have been used in Japan with the largest installation supplying approximately 34 MW of capacity for 6-7 hours of storage; this technology is gaining popularity in the U.S. Sixteen MW of lithium-ion (Li-ion) batteries have also recently been installed in Chile, and a 2-MW pilot project has been executed in the U.S. CAES systems, batteries, super capacitors, flywheels, and pumped storage were compared in a number of reports by Sandia National Laboratories (Sandia), Pacific Northwest National Laboratories (PNNL), and by the California Energy Storage Association (CESA).

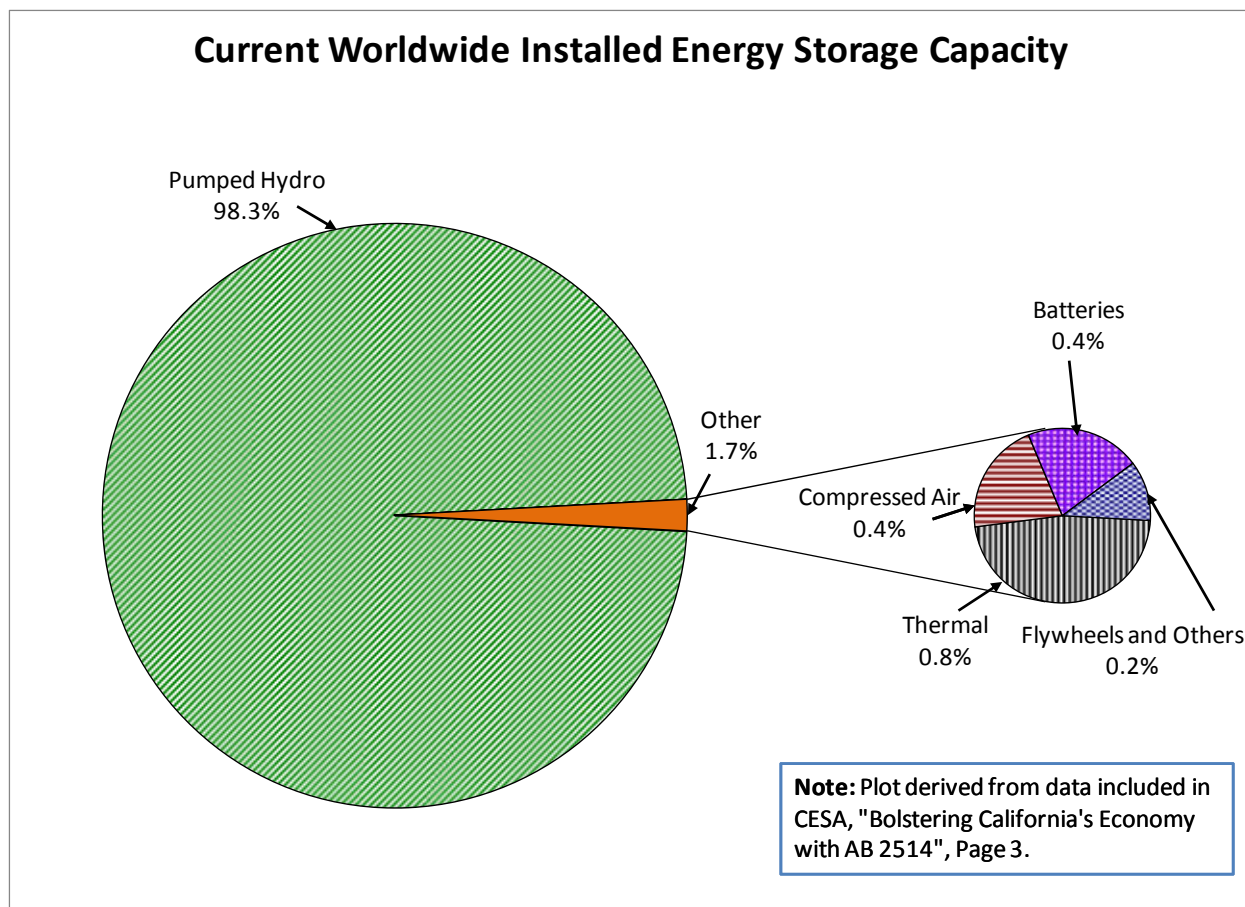

Figure 25 - Current Worldwide Installed Energy Storage Facility Capacity (Source: CESA)

4.2 Applications

Pumped storage and CAES are considered to be the only functional technologies suitable for bulk energy storage as stand-alone applications. Bulk energy storage can be considered multi-hour, multi-day or multi-week storage events. Batteries and flywheels are most functional as a paired system with variable generation resources or for distributed energy storage on a smaller kW and kWh basis. Each of the technologies is capable of providing ancillary services such as frequency regulation and other power quality applications with bulk storage technologies also able to provide system load following and ramping capabilities.

4.3 Space Requirements

Space requirements for energy storage systems vary depending upon capacity and power, and it is often difficult to perform an apples-to-apples comparison of the space requirements for the four technologies discussed above. Pumped storage and CAES are capable of much higher capacities and total energy storage and therefore their project footprint is substantially higher. For example, Table 8 below indicates the surface space requirements for comparable 20,000 MWh facilities: a 1,000-MW, 20-hour pumped storage plant (including upper and lower reservoirs), a Li-ion battery field, and a Na-S battery field. The space required for a pumped storage facility, including reservoirs, is somewhat less in acreage than a Na-S battery field, and far less than that of a Li-ion installation. The artist's rendering in Figure 26 illustrates

the number and size of the Li-ion batteries necessary to store 20,000 MWh of energy. The resulting 1,100 acres would be equivalent to approximately 833 football fields. For scale, a typical pumped storage powerhouse is indicated in the foreground.

Table 8 - Space Required for 20,000 MWh of Energy Storage

Project Type	Approximate Footprint (Acres)
Sodium Sulfur Batteries	270
Li-ion Battery Field	1,100
Pumped Storage Reservoirs	220

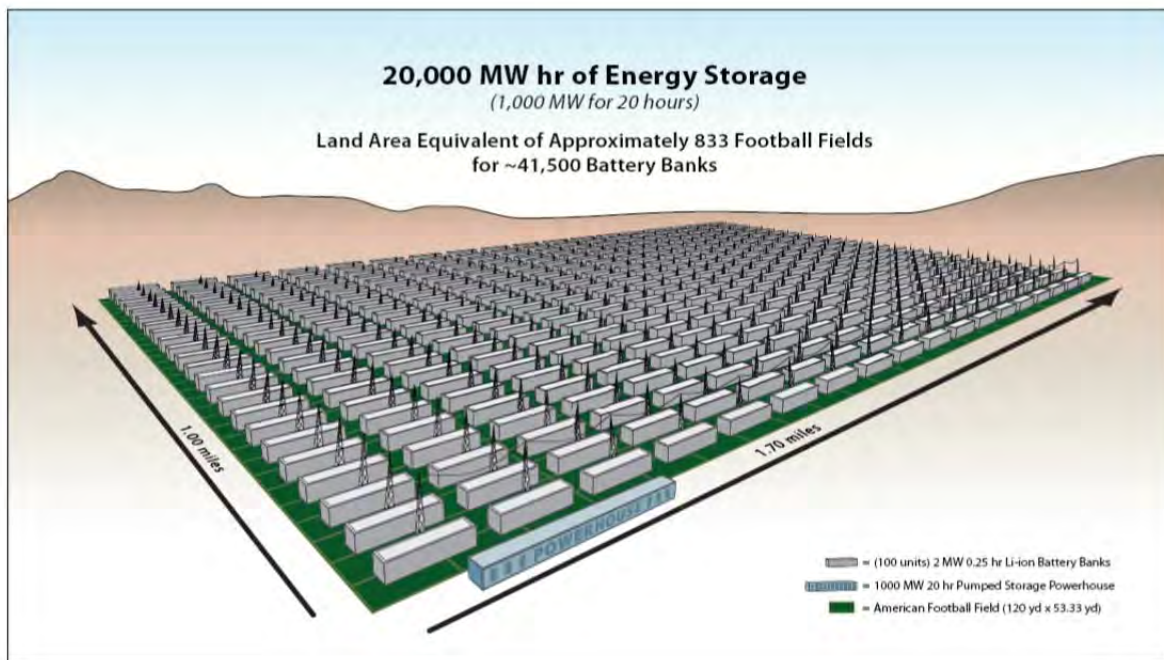

Figure 26 - Li-ion Battery Field and a Hydroelectric P/S Plant for 20,000 MWh of Storage (Source: HDR)

4.4 Performance Characteristics

Project capacity and duration are the most important characteristics for bulk energy storage. For reference, Figures 27 and 28 illustrate the current capability of energy storage technologies. Included in these figures are pumped storage, CAES, various battery technologies flywheels as well as capacitors. Figure 27 is derived from Figure 28 and utilizes the same data, though plotted on a linear scale versus a log-log scale to better reflect the real-time MW and MWh capability of the different technologies. Figure 27 allows for a truer comparison of technologies with smaller capacities and discharge times to larger, longer duration energy storage systems. Figure 28 allows for a closer view of the smaller energy storage technologies.

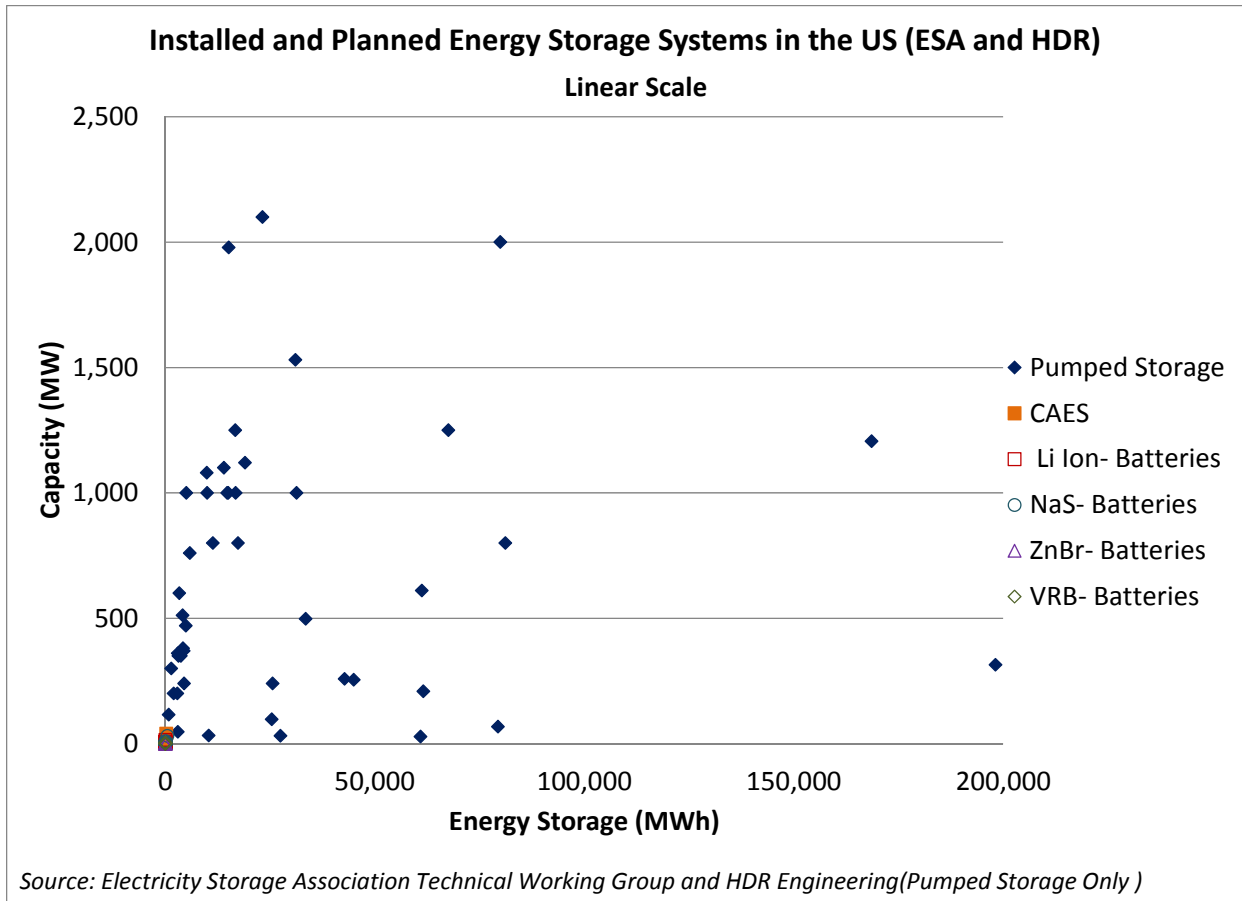

Figure 27 - Current Energy Storage Technology Capabilities in Real Time (Source: HDR)

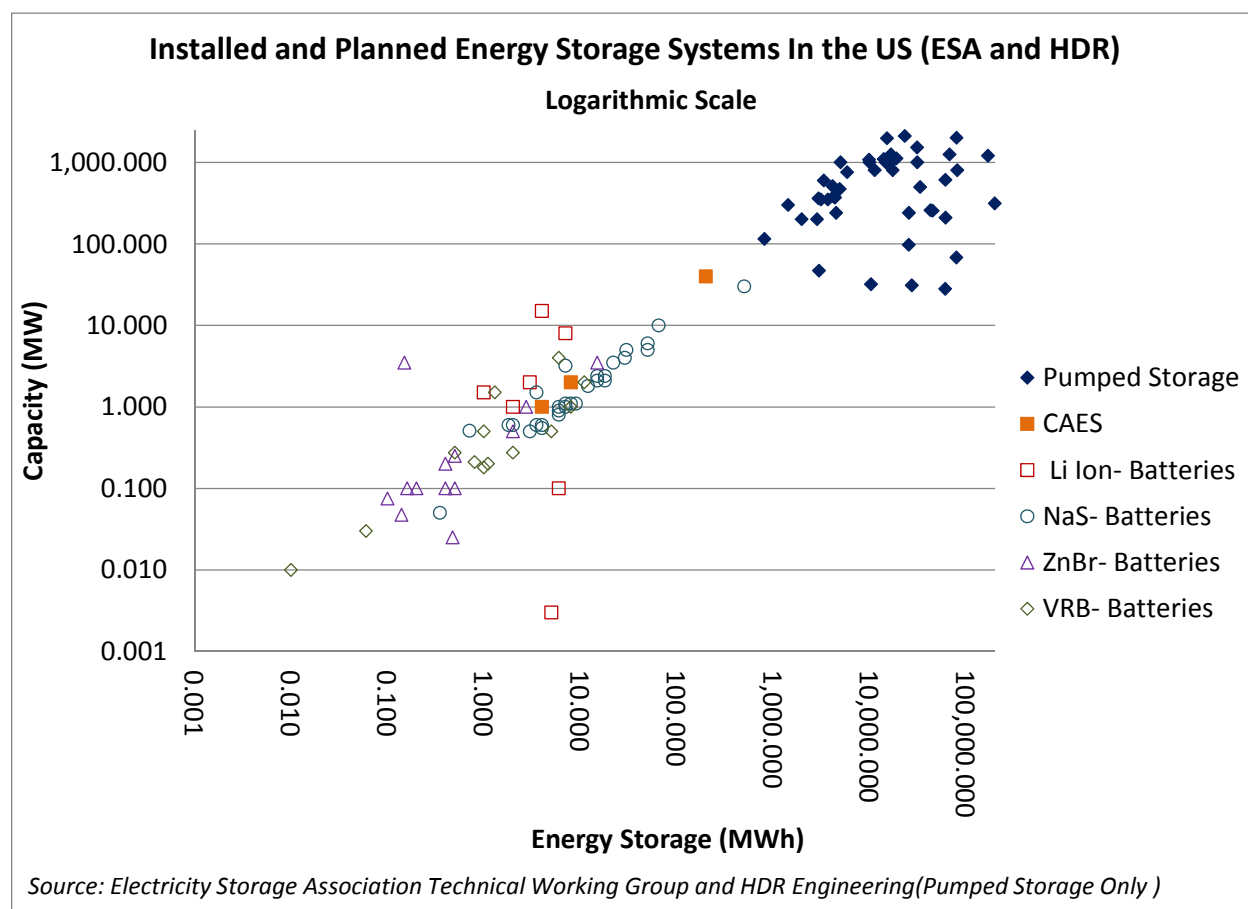

Figure 28 - Current Energy Storage Technology Capabilities (Log-Log Scale)
(Source: Electricity Storage Association)

4.5 Project Timeline

Project timelines vary widely for the various options. Pumped storage lead times require a FERC licensing process which takes on average 5 years. An additional five years is typically required for construction. Greenfield closed loop systems are expected to be shorter to license. There are also efforts within the industry to reduce licensing times and develop more streamlined processes. An example pumped storage development schedule is attached to this document in Appendix B. The timelines for CAES are on the order of 2 years. For both pumped storage and CAES it is assumed that a project location has been identified, and for CAES, the geology of the cavern has been verified. Batteries and flywheels have no licensing requirements and fewer restrictions on land use, so their development times are significantly shorter, on the order of 1 year.

4.6 Cost

There are a number of challenges associated with comparing the different types of energy storage technology. While a conscientious effort was made to discuss the technologies in terms of similarly sized capacities and durations, this comparison is somewhat difficult as the maximum hours of available storage and maximum capacity vary widely from 1 or 2 MW for a lithium-ion battery to over 1,000 MW

for a pumped storage project. As noted earlier, many of these storage systems are still undergoing significant product development, and the maximum storage, capacity, lifetime, capital costs, and lifecycle costs of these technologies have yet to be determined. Also for pumped storage and CAES, site specific conditions can significantly impact the cost and spatial needs for any given project. These challenges emphasize the idea that a portfolio of many different storage technologies may be needed. Table 9 and Figure 29 were developed by HDR based on the information presented in the matrix in Attachment A. While this information is helpful in understanding the capital and O&M costs on a \$ per kW basis, for some technologies, especially batteries, capital costs are better represented with both capacity (kW) and storage (kWh) elements. The capital cost per kW is shown in Table 9 below.

Table 9 - Summary of Cost and Capacity Data (2014 \$US)

	Pumped Storage	A123 Li-Ion	NGK NAS	Prudent VRB	Xtreme Dry Cell	Premium ZnBr	Ecourt Adv. Pb-Acid	CAES
System Cost (\$/kW and/or \$/kWh)	\$1,700-\$2,500 per kW	\$800 - \$1,000 per kW (High Power) \$800 - \$1,200 (High Energy) per kWh	\$4,000 per kW	\$675 per kWh	\$1,900 - 2,100 per kW	\$1,500 - \$2,200 per kWh	~\$1,700 per kW, highly dependent on application	\$2,000-\$2,300 per kW
Rated System (MW)	1000	1 (High Power) 89 (High Energy)	1	1	1	0.5	1	100+
Rated Capacity (hrs)	8 - 10	0.25 (High Power) 4 (High Energy)	7.2 max (standard discharge is 6)	1	0.67 to 2	1	40 ms to 3 hours	8

Capital cost is one initial indicator of project economics, but long-term annual O&M costs may provide a more comprehensive representation of financial feasibility. Figure 29 compares annual costs per kW of various technologies. This figure was updated from the 2011 IRP to escalate costs to 2014 USD by a factor of 6%. Because of the significant difference in capacity of the technologies, the figure is shown in a logarithmic scale. A linear version of the plot is shown in the upper left corner of the figure. Pumped storage O&M costs vary from site to site as discussed above, but economy of scale keeps the O&M cost per kW low. The pumped storage costs represented in Figure 29 are for a 1,000 MW project. CAES's O&M costs are estimated at 4% of the overall installed cost. The operating and maintenance costs associated with batteries are high, but vary depending upon the technologies. As battery technology develops further, and grid scale installations continue, a better understanding of the costs associated with operation and maintenance will be achieved.

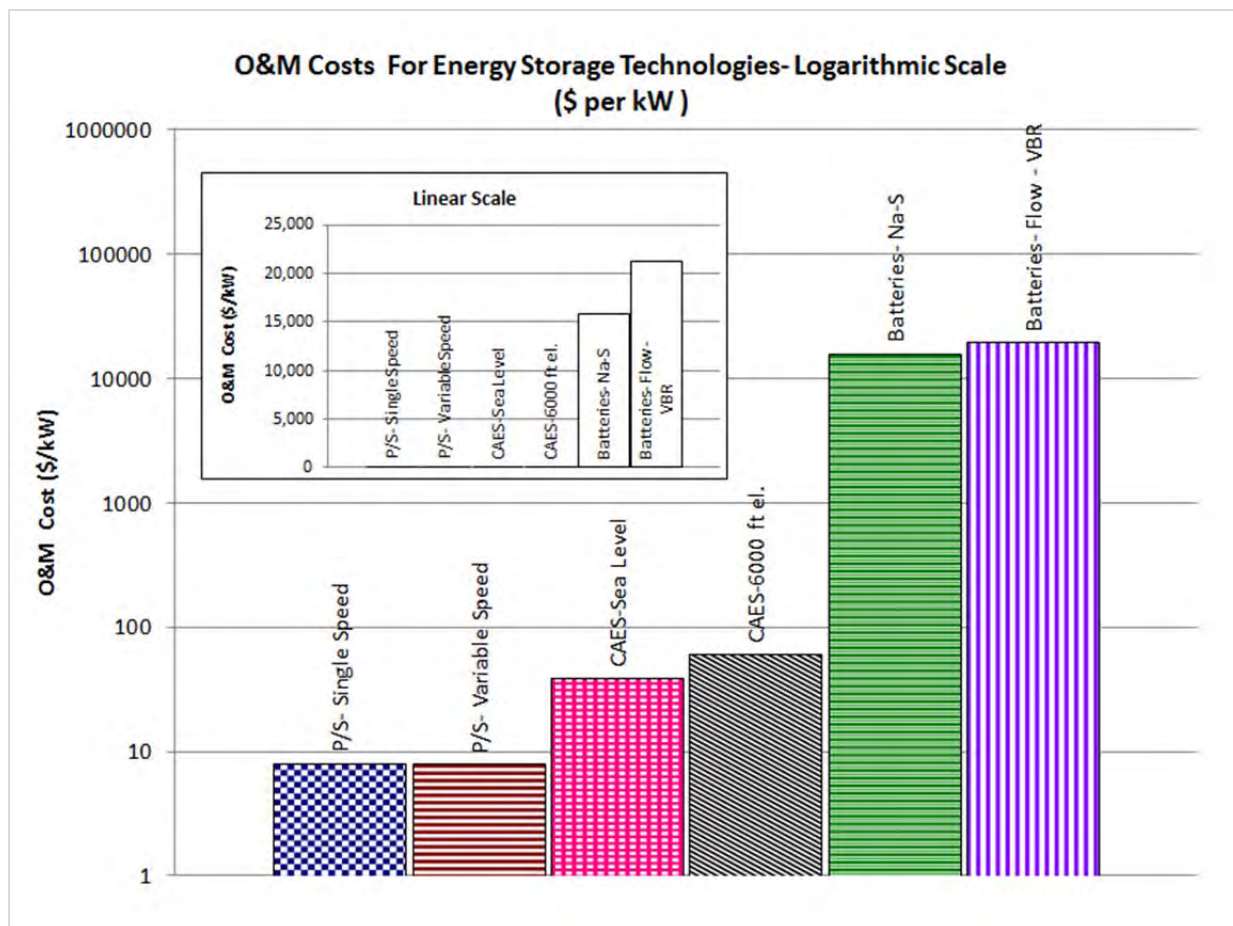

Figure 29 - Operation and Maintenance Costs for Energy Storage Technologies

5 CONCLUSIONS

A number of technologies would be required to smooth variable energy resources, including bulk storage, distributed storage, and transmission system improvements. While there is much debate about the application of new energy storage technologies, for high capacity applications greater than 50 MW, pumped storage represents the least-cost grid-scale storage technology. Pumped Storage is a proven and attractive option in terms of space required, total life cycle costs, and proven MW and MWh capacity. Although CAES has the potential to provide relatively similar bulk storage capabilities, its limited heritage, low efficiency and requirement for geologic-specific siting makes it difficult to implement. For applications less than 50 MW with the goal towards improving the performance of individual, variable energy sources, or a group of such sources, battery and flywheel systems become a feasible alternative. Additionally, battery and flywheel systems have been successfully employed with lower capacities and shorter durations, which make them well suited to short-term storage for general grid stabilization and power quality needs on the order of minutes to a few hours. A variety of complementing technologies will be required to fully address the effects of variable renewable energy, including bulk storage, distributed storage, consolidated balancing areas, and improvements to the interconnecting transmission system.

References

1. Black and Veach, Yale Hydroelectric Plant: Plant Upgrade and Expansion: Preliminary Engineering. 1992.
2. Anthony Charlton, Thomas Haag P.E., Urban Pumped Storage: The Elmhurst Quarry Pumped Storage Project, HydroVision 2011
3. Peter A. Dickson, Kathleen M. King, Storage Options for Hydroelectric Pumped Storage Projects, HydroVision 2011
4. Task Committee on Pumped Storage of the Hydropower Committee of the Energy Division of the American Society of Civil Engineers. "Compendium of Pumped Storage Plants in the United States," (1993).
5. Electrical Power and Research Institute: Pumped storage planning and evaluation guide, Electric Power Research Institute (EPRI); Chicago: HARZA Engineering Company, 1990.
6. Symbiotics, Preliminary Permit Application for the Swan Lake North Pumped Storage Hydroelectric Project, April 2012.
7. Public Utility District No. 1 of Klickitat Countym WA, Application for a Preliminary Permit (Successive) for the JD Pool Pumped Storage Hydroelectric Project, April 2012.
8. Black Canyon Hydro LLC, Preliminary Permit Application for the Black Canyon Pumped Storage Project, January 2011
9. Hydroelectric Pumped Storage for Enabling Variable Energy Resources within the Federal Columbia River Power System, Bonneville Power Administration, HDR 2010
10. Harnessing Variable Renewables *A Guide to the Balancing Challenge*, 2011 International Energy Agency
11. Magnum Energy Investment Profile; Haddington Ventures;
<http://www.opsb.ohio.gov/opsb/index.cfm/cases/99-1626-el-bgn-norton-energy-storage-compressed-air-energy-storage/>
12. First Energy Postpones Project to Generate Electricity with Compressed Air; Cleveland.com News; December 2012;
http://www.cleveland.com/business/index.ssf/2013/07/firstenergy_postpones_project.html
13. Ohio Power Siting Board; September 2013;
<http://www.opsb.ohio.gov/opsb/index.cfm/cases/99-1626-el-bgn-norton-energy-storage-compressed-air-energy-storage/>
14. Compressed Air Energy Storage, PG&E;
<http://www.pge.com/en/about/environment/pge/cleanenergy/caes/index.page>
15. Huntorf Profile, E.ON; <http://www.eon.com/en/about-us/structure/asset-finder/huntorf.html>
16. RWE Energy ADELE; <http://www.rwe.com/web/cms/en/365478/rwe/innovation/projects-technologies/energy-storage/project-adele-adele-ing/>
17. Lessons Learned from Iowa: Development of a 270 MW CAES Storage Project in MISO; Sandia National Laboratories; June 2012; <http://www.sandia.gov/ess/publications/120388.pdf>
18. "Process". *company website*. Highview Power Storage. Retrieved 2012-10-07.
19. Roger Harrabin, BBC Environment analyst (2012-10-01). "Liquid air 'offers energy storage hope'". *BBC News, Science and Environment*. **BBC**. Retrieved 2012-10-02.

20. Cheung K.Y.C, Cheung S.T.H, Navin De Silvia R.G, Juvonen M.P.T, Singh R, Woo J.J. *Large-Scale Energy Storage Systems*. Imperial College London: ISE2, 2002/2003.
21. "Maxwell Technologies Ultracapacitors (ups power supply) Uninterruptible Power Supply Solutions". Maxwell.com. Retrieved 2013-05-29.
22. International Energy Agency, Photovoltaic Power Systems Program, The role of energy storage for mini-grid stabilization, IEA PVPS Task 11, Report IEA-PVPS T11-02:2011, July 2011
23. J. R. Miller, JME, Inc. and Case Western Reserve University, Capacitors for Power Grid Storage, (Multi-Hour Bulk Energy Storage using Capacitors)
24. Wolsky, A., M. (2002). The status and prospects for flywheels and SMES that incorporate HTS. *Physica C* 372–376, pp. 1,495–1,499.
25. "ADELE – Adiabatic compressed-air energy storage (CAES) for electricity supply". Retrieved December 31, 2011.
26. CAES:McIntosh Power Plant, PowerSouth Energy Cooperative, 2010, retrieved April 15, 2012

APPENDIX R – UNCERTAINTY PARAMETERS STUDY

In its 2013 IRP, the Company indicated its intent to re-estimate key stochastic parameters for purposes of ABB’s Planning and Risk (PaR) model runs used in the 2015 IRP. As such, PacifiCorp hired Erin O’Neill, an independent consultant, to re-estimate short-term stochastic parameters (volatilities, mean reversions, and correlations) for load, natural gas prices, electricity prices, and hydro generation.

PaR, as used by PacifiCorp, develops portfolio cost scenarios via computational finance in concert with production simulation. The model stochastically shocks the case-specific underlying electricity price forecast as well as the corresponding case-specific key drivers (e.g., natural gas, loads, and hydro) and dispatches accordingly. Using exogenously calculated parameters (i.e., volatilities, mean reversions, and correlations), PaR develops scenarios that bracket the uncertainty surrounding a driver; statistical sampling techniques are then employed to limit the number of representative scenarios to 50. The stochastic model used in PaR is a two-factor short run mean reverting model.

For this IRP, PacifiCorp used short-run stochastic parameters; long-run parameters were set to zero since PaR cannot re-optimize its capacity expansion plan. This inability to re-optimize or add capacity can create a problem when dispatching to meet extreme load and/or fuel price excursions, as often seen in long-term stochastic modeling. Such extreme out-year price and load excursions can influence portfolio costs disproportionately while not reflecting plausible outcome. Thus, since long-term volatility is the year-on-year growth rate, only the expected yearly price and/or load growth is simulated over the forecast horizon⁵³.

Key drivers that significantly affect the determination of prices tend to fall into two categories: loads and fuels. Targeting only key variables from each category simplifies the analysis while effectively capturing sensitivities on a larger number of individual variables. For instance, load uncertainty can encompass the sensitivities of weather and evolving end-uses. Depending on the region, fuel price uncertainty (especially that of natural gas) can encompass the sensitivities of weather, load growth, emissions, and hydro availability. The following paper, *Uncertainty Representation for PacifiCorp's Long Range Plan*, summarizes the development of stochastic process parameters to describe how these uncertain variables evolve over time.

Ms. O’Neill’s previous works include:

Grossman, Britt, Nicholas Muller, and Erin O’Neill. “The Ancillary Benefits from Climate Policy in the United States.” *Environmental Resource Economics* (2011) 50:585-60.

O’Neill, Erin, and T. Parkinson. “Uncertainly Representation: Estimating Process Parameters for Forward Price Forecasting.” EPRI, Palo Alto, CA, and The NorthBridge Group, Lincoln, MA: 1999. TR-114201.

O’Neill, Erin. “Guide to Process Parameter Estimation Tool Kit.” EPRI, Palo Alto, CA, and The NorthBridge Group, Lincoln, MA: 2000. EPRI 1001172.

O’Neill, Erin. “Cost-Effective Strategies for Nitrogen Oxide Reduction: Ozone Attainment Policy for New England.” M.S. thesis, Massachusetts Institute of Technology, Cambridge, 1996.

⁵³Mean reversion is assumed to be zero in the long run.

Uncertainty Representation for PacifiCorp's Long Range Plan

July 2014

Prepared for
PacifiCorp
825 NE Multnomah Street
Portland, OR 97232

Prepared by
Erin O'Neill
Independent Consultant
1542 Valley View Court
Golden, CO 80403

INTRODUCTION

Long-term planning demands specification of how important variables behave over time. For the case of PacifiCorp's long-term planning, important variables include natural gas and electricity prices, regional loads, and regional hydro generation. Modeling these variables involves not only a description of their expected value over time as with a traditional forecast, but also a description of the spread of possible future values. The following paper summarizes the development of stochastic process parameters to describe how these uncertain variables evolve over time⁵⁴.

VOLATILITY

The standard measure of uncertainty for a stochastic variable is volatility:

$$\text{Volatility} = \frac{\text{Standard Deviation}}{\sqrt{\text{Time}}}$$

The standard deviation⁵⁵ is a measure of how widely values are dispersed from the average value:

$$\text{Standard Deviation} = \sqrt{\frac{\sum_{i=1}^n (x_i - \text{average})^2}{(n - 1)}}$$

Volatility incorporates a time component so a variable with constant volatility has a larger spread of possible outcomes two years in the future than one year in the future. Volatilities are typically quoted on an annual basis but can be specified for any desired time period. Suppose the annual volatility of load in Idaho is 2 percent. This implies that the standard deviation of the range of possible loads in Idaho a year from now is 2 percent, while the standard deviation four years from now is 4 percent.

MEAN REVERSION

If volatility were constant over the forecast period, then the standard deviation would increase linearly with the square root of time. This is described as a "Random Walk" process and often provides a reasonable assumption for long-term uncertainty. However, for energy commodities as well as many other variables in the short-term, this is not typically the case. Excepting seasonal effects, the standard deviation increases less quickly with longer forecast time. This is called a mean reverting process - variable outcomes tend to revert back towards a long-term mean after experiencing a shock:

⁵⁴ A stochastic process, or random process, is the counterpart to a deterministic process. Instead of dealing with only one possible reality of how the variables might evolve over time, there is some indeterminacy in its future evolution described by probability distributions.

⁵⁵ "Standard Deviation" and "Variance" are standard statistical terms describing the spread of possible outcomes. The Variance equals the Standard Deviation squared.

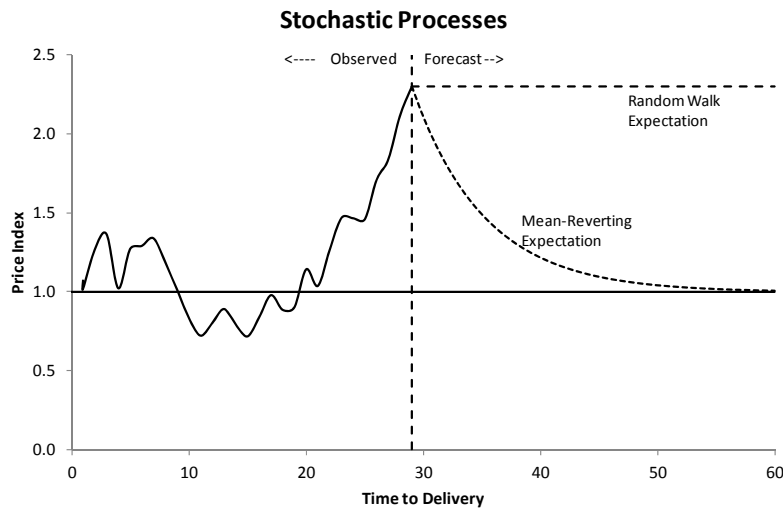

Figure 1

For a random walk process, the distribution of possible future outcomes continues to increase indefinitely. While for a mean reverting process, the distribution of possible outcomes reaches a steady-state. Actual observed outcomes will continue to vary within the distribution, but the distribution across all possible outcomes does not increase:

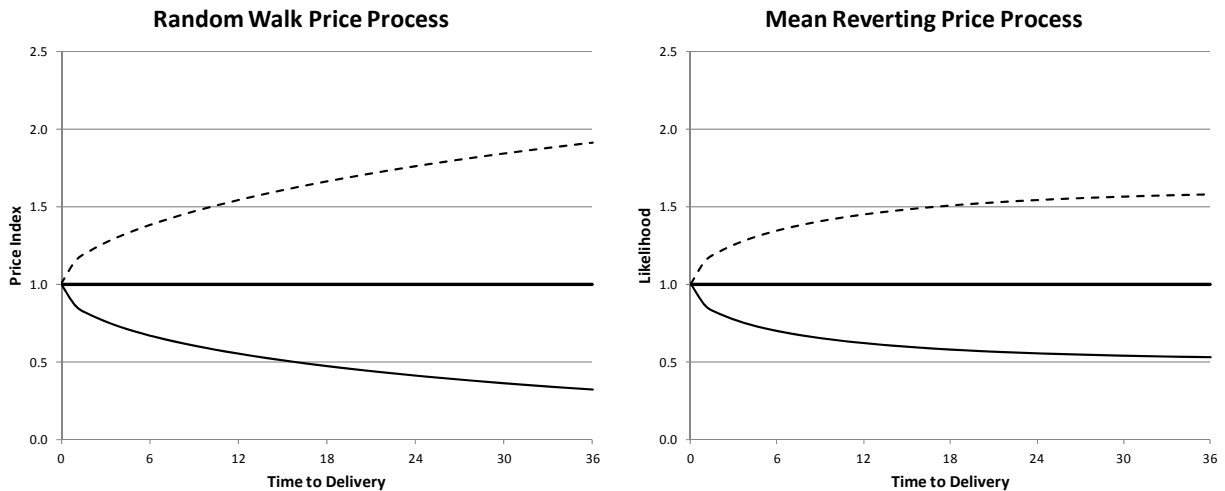

Figure 2

The volatility and mean reversion rate parameters combine to provide a compact description of the distribution of possible variable outcomes over time. The volatility describes the size of a typical shock or deviation for a particular variable and the mean reversion rate describes how quickly the variable moves back towards the long-run mean after experiencing a shock.

ESTIMATING SHORT-TERM PROCESS PARAMETERS

Short-term uncertainty can best be described as a mean reverting process. The factors that drive uncertainty in the short-term are generally short-lived, decaying back to long-run average levels. Short-term uncertainty is mainly driven by weather (temperature, windiness, rainfall) but can also be driven by short-term economic factors, congestion, outages, etc.

The process for estimating short-term uncertainty parameters is similar for most variables of interest. However, each of PacifiCorp's variables have characteristics that make their processes slightly different. The process for estimating short-term uncertainty parameters is described in detail below for the most straightforward variable -- natural gas prices. Each of the other variables is then discussed in terms of how they differ from the standard natural gas price parameter estimation process.

STOCHASTIC PROCESS DESCRIPTION

The first step in developing process parameter estimates for any uncertain variable is to determine the form of the distribution and time step for uncertainty. In the case of natural gas, and prices in general, the lognormal distribution is a good representation of possible future outcomes. A lognormal distribution is a continuous probability distribution of a random variable whose logarithm is normally distributed⁵⁶. The lognormal distribution is often used to describe prices because it is bounded on the bottom by zero and has a long, asymmetric "tail" reflecting the possibility that prices could be significantly higher than the average:

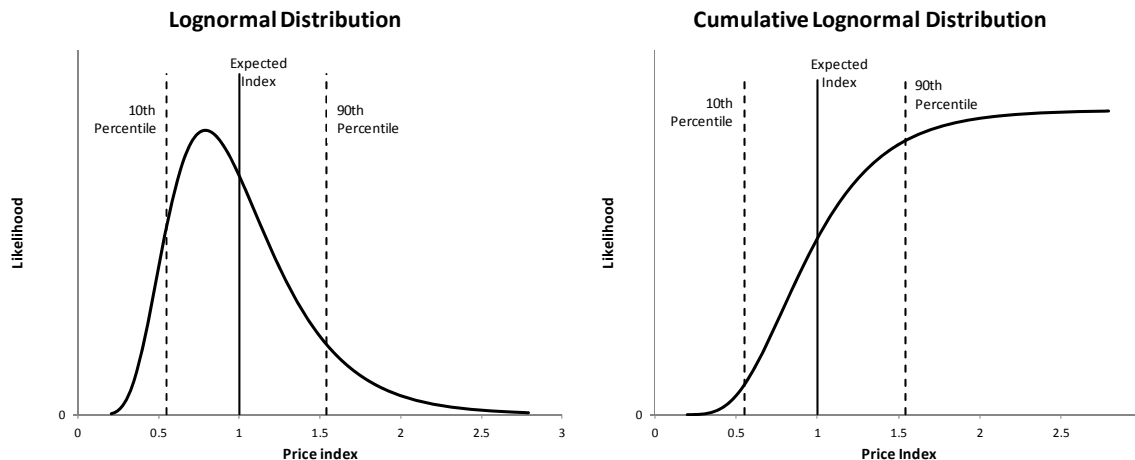

Figure 3

The time step for calculating uncertainty parameters depends on how quickly a variable can experience a significant change. Natural gas prices can change substantially from day to day and are reported on a daily basis, so the time step for analysis will be one day.

All short-term parameters were calculated on a seasonal basis to reflect the different dynamics present during different seasons of the year. For instance, the volatility of gas prices is higher in the winter and lower in the spring and summer. Seasons were defined as follows:

Table 1 - Seasonal Definition

Winter	December, January, and February
Spring	March, April, and May
Summer	June, July, and August
Fall	September, October, and November

⁵⁶ A normal distribution is the most common continuous distribution represented by a bell-shaped curve that is symmetrical about the mean, or average, value.

DATA DEVELOPMENT

Basic Data Set:

The natural gas price data were organized into a consistent dataset with one natural gas price for each gas delivery point reported for each delivery day. The data were checked to make sure that there were no missing or duplicate dates. If no price is reported for a particular date, the date is included but left blank to maintain a consistent 24 hour time step between all observed prices. Four years of daily data from 2010 to 2013 was used for this short-term parameter analysis. The following chart shows the resulting data set for the Sumas gas basin:

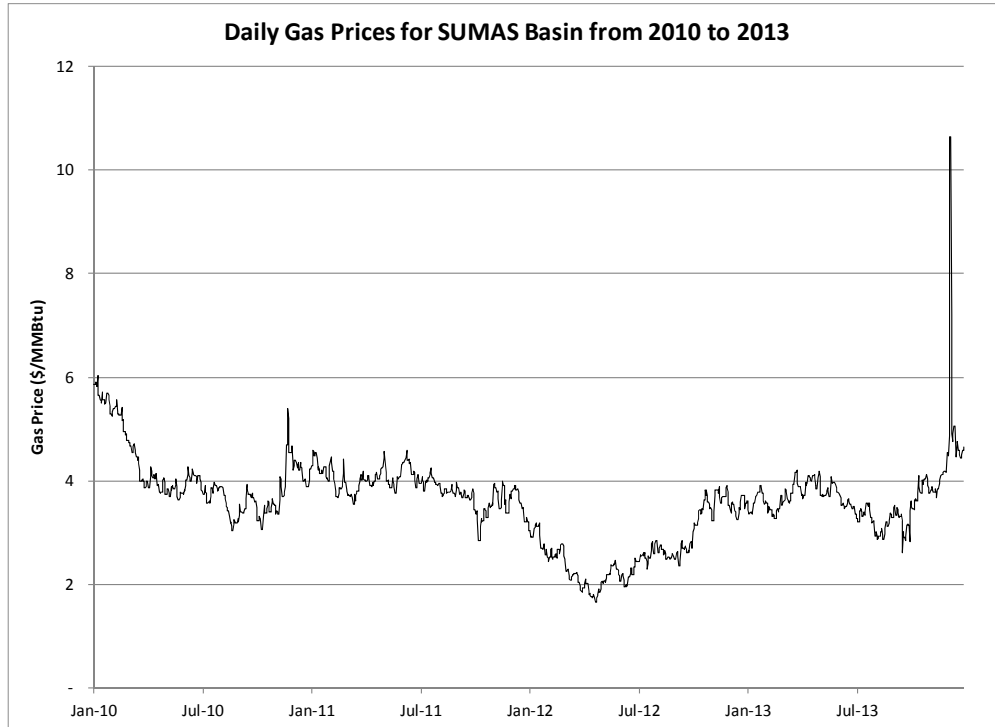

Figure 4

Development of Price Index:

Uncertainty parameters are estimated by looking at the movement, or deviation, in prices from one day to the next. However, some of this movement is due to expected factors, not uncertainty. For instance, gas prices are expected to be higher during winter or as we move towards winter. This expectation is already included in the gas price forecast and should not be considered a shock, or random event. In order to capture only the random or uncertain portion of price movements, a price index is developed that takes into account the expected portion of price movements. There are three categories of price expectations that are calculated:

Seasonal Average: The level of gas prices may be different from one year to the next. While this can be attributed to random movements or shocks in the gas markets, it is not a short-term event and should not be included in the short-term uncertainty process. In order to account for this possible difference in the level of gas prices, the average gas price for each season and year is calculated. For example, Sumas prices in the winter of 2010 average \$4.99/MMBtu.

Monthly Average: Within a season, there are different expected prices by month. For instance, within the fall season, November gas prices are expected to be much higher than September and October prices as winter is just around the corner. A monthly factor representing the ratio of monthly prices to the seasonal average price is calculated. For example, January prices in Sumas are 102% of the winter average price.

Weekly Shape: Many variables exhibit a distinct shape across the week. For instance, loads and electricity prices are higher during the middle of the week and lower on the weekends. The expected shape of gas prices across the week was calculated but found to be insignificant (expected variation by weekday did not exceed 2% of the weekly average).

These three components: seasonal average, monthly shape, and weekly shape, combine to form an expected price for each day. For example, the expected price of gas in Sumas in January of 2010 was \$5.10/MMBtu, the product of the seasonal average and the monthly shape factor

$$\text{Expected Gas Price} = \text{Seasonal Avg. Price} * \text{Monthly Shape within the Season}$$

The chart below shows the comparison of the actual Sumas prices with the "expected" prices:

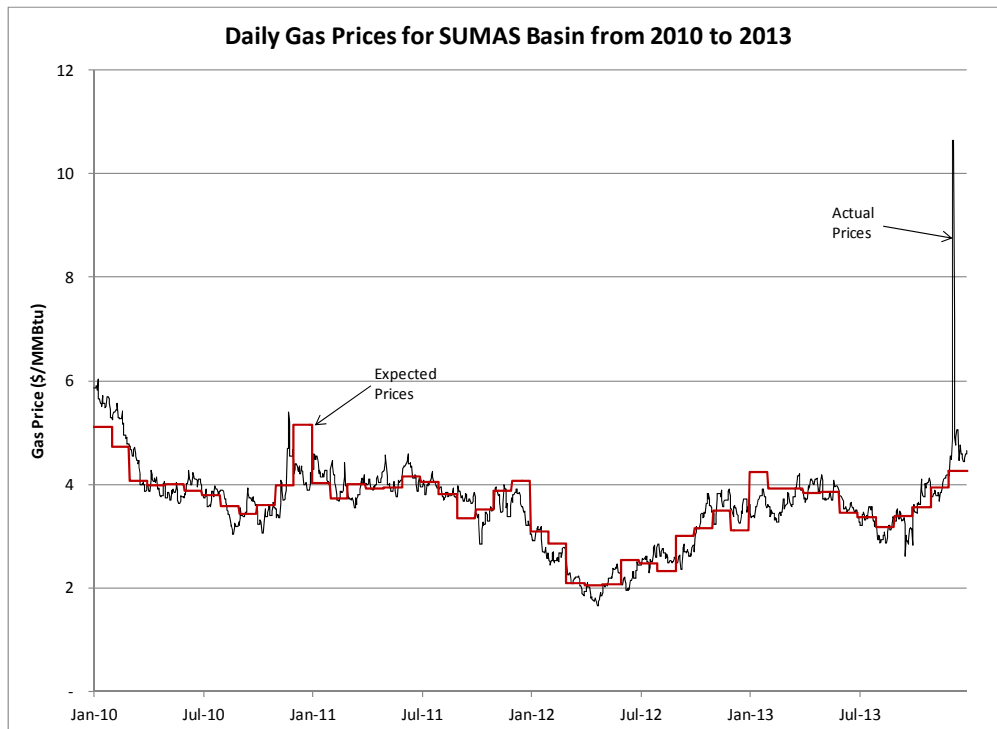

Figure 5

Dividing the actual gas prices by the expected prices forms a price index that averages one. This index captures only the random component of price movements -- the portion not explained by expected seasonal, monthly, and weekly shape.

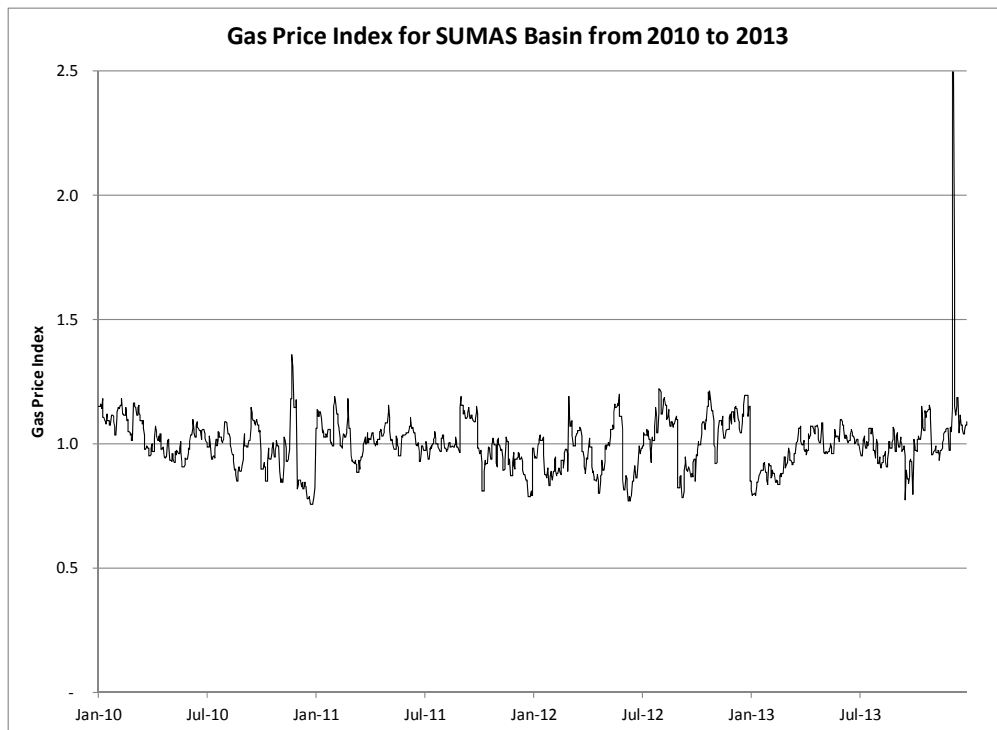

Figure 6

PARAMETER ESTIMATION -- AUTOREGRESSIVE MODEL

Uncertainty parameters are calculated for each variable by regressing the movement of each regions price index compared to the previous day's index.

Step 1 - Calculate Log Deviation of Price Index

Since gas prices are log normally distributed, the regression analysis is performed on the natural log of prices and their log deviations. The log deviations are simply the differences between the natural log of one day's price index and the natural log of the previous day's price index.

Step 2 - Perform Regression

The log deviation of prices are regressed against the previous day's log price for each season as well as for the entire data set. The following chart shows the log of the price index versus the log deviations for Sumas gas for all seasons and the resulting regression equation:

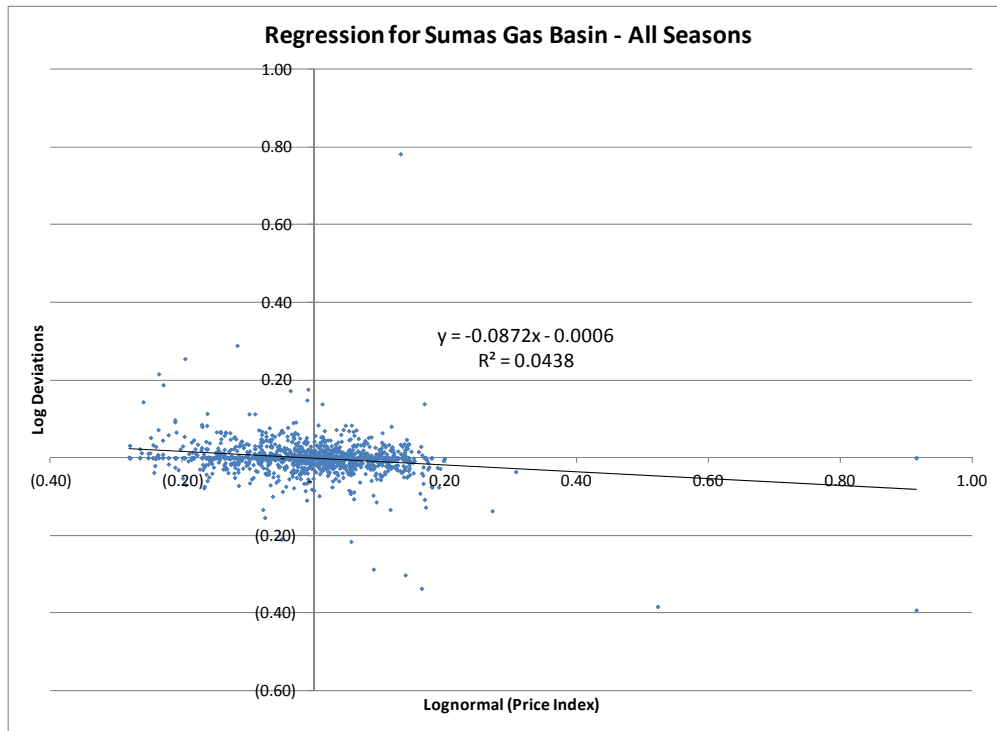

Figure 7

Step 3 - Interpret the Results

The *INTERCEPT* of the regression represents the log of the long-run mean. So in this case, the intercept is approximately zero, implying that the long-run mean is equal to 1. This is consistent with the way in which the price index is formulated.

The *SLOPE* of the regression is related to the auto correlation and mean reversion rate:

$$\begin{aligned} \text{auto correlation} &= \emptyset = 1 + \text{slope} \\ \text{Mean Reversion Rate } \alpha &= -\ln(\emptyset) \end{aligned}$$

The autocorrelation measures how much of the price shock from the previous time period remains in the next time period. For instance, if the autocorrelation is 0.4 and gas prices yesterday experienced a 10% jump over the norm, today's expected price would be 4% higher than normal. In addition, today's gas price will experience a shock today that may result in prices higher or lower than this expectation. The mean reversion rate expresses the same thing in a different manner. The higher the mean reversion rate, the faster prices revert to the long-run mean.

The last component of the regression analysis is the *STANDARD ERROR* or *STEYX*. This measures the portion of the price movements not explained by mean reversion and is the estimate of the variable's volatility.

Both the mean reversion rate and volatility calculated with this process are daily parameters and can be applied directly to daily movements in gas prices.

Step 4 - Results

The natural gas price parameters derived through this process are reported in the table below.

Table 2 - Uncertainty Parameters for Natural Gas

	Winter	Spring	Summer	Fall
KERN OPAL				
Daily Volatility	4.8%	2.9%	2.9%	3.6%
Daily Mean Reversion Rate	0.058	0.110	0.060	0.110
SUMAS				
Daily Volatility	6.3%	2.6%	2.9%	4.3%
Daily Mean Reversion Rate	0.091	0.083	0.070	0.109

ELECTRICITY PRICE PROCESS

For the most part, electricity prices behave very similar to natural gas prices. The lognormal distribution is generally a good assumption for electricity. While electricity prices do occasionally go below zero, this is not common enough to be worth using the Normal distribution assumption. And the distribution of electricity prices is often very skewed upwards. In fact, even the lognormal assumption is sometimes inadequate for capturing the tail of the electricity price distribution. Similar to gas prices, electricity price can experience substantial change from one day to the next so a daily time step should be used.

Basic Data Set:

The electricity price data were organized into a consistent dataset with one price for each region reported for each delivery day similar to gas prices. Data covers the 2010 through 2013 time period. However, electricity prices are reported for "High Load Level" periods (16 hours for 6 days a week) and "Low Load Level" periods (8 hours for 6 days a week and 24 hours on Sunday & NERC holidays). In order to have a consistent price definition, a composite price calculated based on 16 hours of peak and 8 hours of off-peak prices is used for Monday through Saturday. The Low Load Level price was used for Sundays since that already reflects the 24 hour price. Missing and duplicate data is handled in a fashion similar to gas prices.

Development of Price Index:

As with gas prices, an electricity price index was developed which accounts for the expected components of price movements. The "expected" electricity price incorporates all three possible adjustments: seasonal average, monthly shape and weekly shape. For instance, the expected price for January 2nd, 2010 in the Four Corners region was \$38.42/MWh. This price incorporates the 2010 winter average price of \$39.00/MWh times the monthly shape factor for January of 99% and the weekday index for Saturday of 99%. The following chart shows the Four Corners actual and expected electricity prices over the analysis time period.

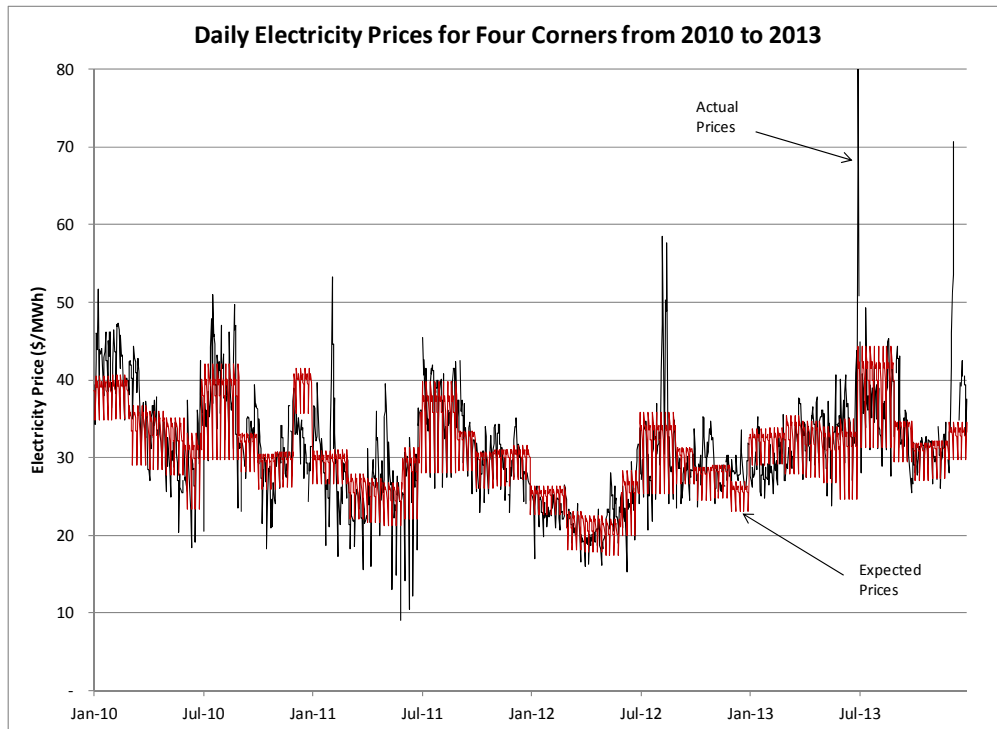

Figure 8

Electricity Price Uncertainty Parameters

Uncertainty parameters are calculated for each electric region similar to the process for gas prices. The electricity price parameters derived through this process are reported in the table below.

Table 3 - Uncertainty Parameters for Electricity Regions

	Winter	Spring	Summer	Fall
Four Corners				
Daily Volatility	7.6%	9.2%	11.1%	6.0%
Daily Mean Reversion Rate	0.095	0.277	0.380	0.240
CA-OR Border				
Daily Volatility	11.8%	31.8%	25.7%	6.3%
Daily Mean Reversion Rate	0.193	0.682	0.534	0.168
Mid-Columbia				
Daily Volatility	17.8%	31.7%	47.7%	6.9%
Daily Mean Reversion Rate	0.282	0.488	0.943	0.152
Palo Verde				
Daily Volatility	6.2%	7.2%	9.1%	4.7%
Daily Mean Reversion Rate	0.093	0.198	0.289	0.217

REGIONAL LOAD PROCESS

There are only two significant differences between the uncertainty analysis for regional loads and natural gas prices. The distribution of daily loads is somewhat better represented by a normal distribution rather than a lognormal distribution. And, similar to electricity prices, loads have a significant expected shape across the week. The chart below shows the distribution of historical load outcomes for the Portland area as well as normal and lognormal distribution functions representing load possibilities. Both distributions do a reasonable job of representing the spread

of possible load outcomes but the tail of the lognormal distribution implies the possibility of higher loads than is supported by the historical data.

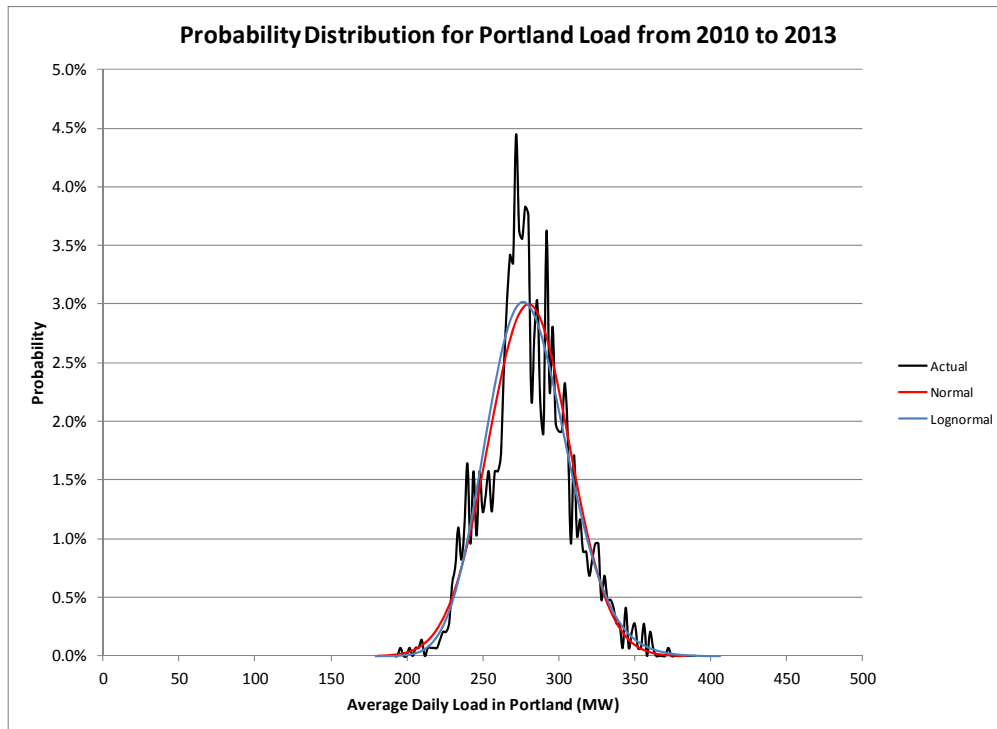

Figure 9

Development of Load Index:

As with electricity prices, a load index was developed which accounts for the expected components of load movements incorporating all three possible adjustments. For instance, the expected load for January 2nd, 2010 in Portland was 311MW. This load incorporates the 2010 winter average load of 304MW times the monthly shape factor for January of 100% and the weekday index for Saturday of 95%. The following chart shows the Portland actual and expected loads over the analysis time period.

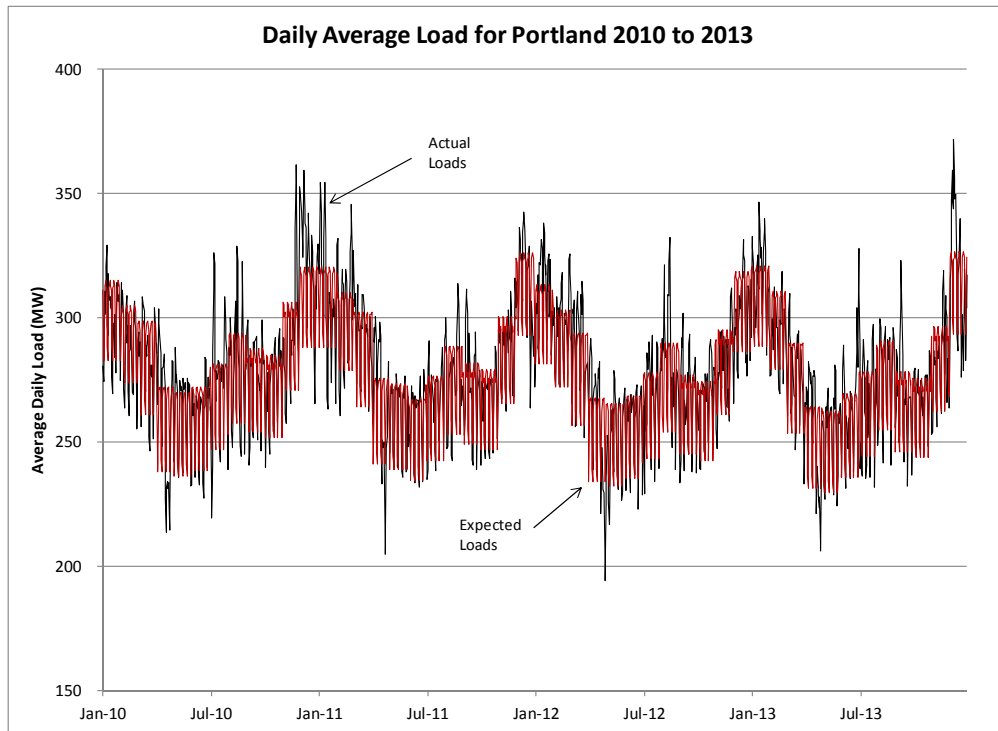

Figure 10

Load Uncertainty Parameters

Uncertainty parameters are calculated for each load region similar to the process for gas and electricity prices. Since loads are modeled as normally, rather than lognormally distributed, deviations are simply calculated as the difference between the load index and the previous day's index.

The uncertainty parameters for regional loads derived through this process are reported in the table below.

Table 4 - Uncertainty Parameters for Load Regions

	Winter	Spring	Summer	Fall
California				
Daily Volatility	4.3%	4.0%	3.4%	4.6%
Daily Mean Reversion Rate	0.227	0.251	0.193	0.206
Idaho				
Daily Volatility	2.9%	4.5%	5.1%	4.8%
Daily Mean Reversion Rate	0.268	0.093	0.102	0.176
Portland				
Daily Volatility	3.0%	2.9%	3.5%	3.1%
Daily Mean Reversion Rate	0.224	0.164	0.336	0.324
Oregon Other				
Daily Volatility	4.5%	3.6%	3.6%	3.9%
Daily Mean Reversion Rate	0.226	0.280	0.242	0.207
Utah				
Daily Volatility	2.0%	2.5%	4.5%	2.9%
Daily Mean Reversion Rate	0.333	0.295	0.260	0.339
Washington				
Daily Volatility	4.3%	3.6%	4.6%	4.2%
Daily Mean Reversion Rate	0.215	0.220	0.243	0.182
Wyoming				
Daily Volatility	1.6%	1.6%	1.5%	1.8%
Daily Mean Reversion Rate	0.279	0.318	0.179	0.230

HYDRO GENERATION PROCESS

There are two differences between the uncertainty analysis for hydro generation and natural gas prices. Hydro generation varies on a slower time frame than other variables analyzed. As such, average hydro generation is calculated and analyzed on a weekly, rather than daily, basis. Generation is calculated as the average hourly generation across the 168 hour in a week. In addition, an extra year of data was analyzed for hydro generation. The hydro analysis covers the 2009 through 2013 time period.

Development of Hydro Index:

A hydro generation index was developed which accounts for the expected components of hydro movements incorporating seasonal and monthly adjustments. For instance, the expected hydro generation for the week of January 1st through 7th, 2009 in the Western Region was 548MW. This generation incorporates the 2009 winter average generation of 471MW times the monthly shape factor for January of 116%. The following chart shows the western hydro actual and expected generation over the analysis time period.

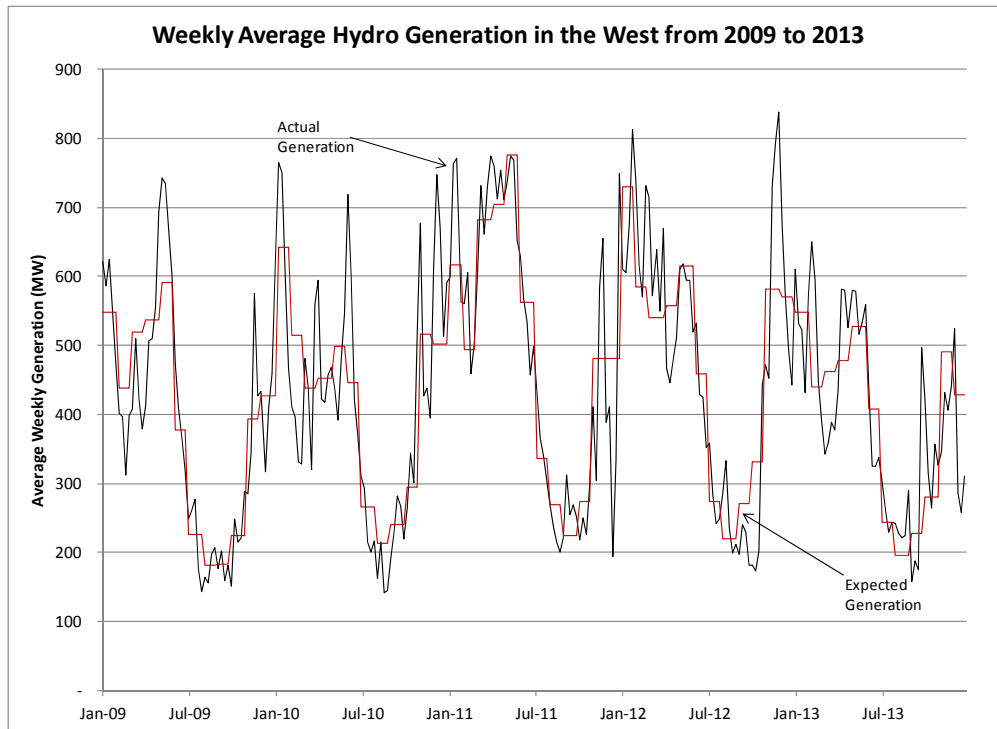

Figure 11

Hydro Generation Uncertainty Parameters

Uncertainty parameters are calculated for each hydro region similar to the process for gas and electricity prices. The uncertainty parameters for hydro generation derived through this process are reported in the table below.

Table 5 - Uncertainty Parameters for Hydro Generation

	Winter	Spring	Summer	Fall
Daily Volatility	23%	19%	17%	31%
Daily Mean Reversion Rate	0.52	0.25	0.39	0.60

SHORT TERM CORRELATION ESTIMATION

Correlation is a measure of how much the random component of variables tend to move together. After the uncertainty analysis has been performed, the process for estimating correlations is relatively straight-forward.

Step 1 - Calculate Residual Errors

Calculate the residual errors of the regression analysis for all of the variables. The residual error represents the random portion of the deviation not explained by mean reversion. It is calculated for each time period as the difference between the actual value and the value predicted by the linear regression equation:

$$Error = Actual\ Deviation - (Slope * Previous\ Deviation + Intercept)$$

All of the residual errors are compiled by delivery date.

Step 2 - Calculate Correlations

Correlate the residual errors of each pair of variables:

$$Correlation(X, Y) = \frac{\sum_i^n [(x_i - x_{avg.}) * (y_i - y_{avg.})]}{\sqrt{\sum_i^n (x_i - x_{avg.})^2 * \sum_i^n (y_i - y_{avg.})^2}}$$

There are a few things to note about the correlation calculations. First, correlation data must always be organized so that the same time period is being compared for both variables. So for instance, weekly hydro deviations cannot be compared to daily gas price deviations. Thus, a daily regression analysis was performed for the hydro variables.

Also note that what is being correlated is the residual errors of the regression -- only the uncertain portion of the variable movements. Variables may exhibit similar expected shapes - both loads and electricity prices are higher during the week than on the weekend. This coincidence is captured in the expected weekly shapes input into the planning model. The correlation calculated here captures the extent to which the shocks experienced by two different variables tend to have similar direction and magnitude:

The resulting short-term correlations by season are reported below:

Table 6 - Short-term Correlations by Season

SHORT-TERM WINTER CORRELATIONS

	K-O	SUMAS	4C	COB	Mid-C	PV	CA	ID	Portland	OR Other	UT	WA	WY	Hydro
K-O	100%	71%	31%	18%	13%	32%	13%	16%	19%	14%	20%	14%	15%	4%
SUMAS	71%	100%	21%	18%	15%	14%	10%	11%	23%	18%	19%	21%	15%	2%
4C	31%	21%	100%	63%	57%	80%	13%	15%	13%	16%	22%	20%	9%	2%
COB	18%	18%	63%	100%	95%	62%	13%	8%	17%	27%	15%	28%	10%	3%
Mid-C	13%	15%	57%	95%	100%	52%	10%	9%	14%	24%	15%	24%	12%	3%
PV	32%	14%	80%	62%	52%	100%	9%	15%	5%	8%	17%	13%	5%	3%
CA	13%	10%	13%	13%	10%	9%	100%	17%	47%	75%	29%	45%	18%	-2%
ID	16%	11%	15%	8%	9%	15%	17%	100%	24%	26%	41%	30%	26%	-2%
Portland	19%	23%	13%	17%	14%	5%	47%	24%	100%	74%	47%	66%	29%	0%
OR Other	14%	18%	16%	27%	24%	8%	75%	26%	74%	100%	42%	71%	30%	2%
UT	20%	19%	22%	15%	15%	17%	29%	41%	47%	42%	100%	40%	40%	3%
WA	14%	21%	20%	28%	24%	13%	45%	30%	66%	71%	40%	100%	29%	0%
WY	15%	15%	9%	10%	12%	5%	18%	26%	29%	30%	40%	29%	100%	-1%
Hydro	4%	2%	2%	3%	3%	3%	-2%	-2%	0%	2%	3%	0%	-1%	100%

SHORT-TERM SPRING CORRELATIONS

	K-O	SUMAS	4C	COB	Mid-C	PV	CA	ID	Portland	OR Other	UT	WA	WY	Hydro
K-O	100%	76%	10%	7%	12%	11%	13%	4%	1%	-2%	-3%	-3%	1%	-1%
SUMAS	76%	100%	11%	7%	11%	12%	12%	3%	12%	13%	0%	7%	2%	-6%
4C	10%	11%	100%	62%	40%	82%	-2%	14%	2%	4%	9%	9%	-4%	-13%
COB	7%	7%	62%	100%	85%	60%	0%	5%	5%	7%	4%	14%	1%	-3%
Mid-C	12%	11%	40%	85%	100%	29%	-2%	10%	9%	6%	9%	17%	-1%	1%
PV	11%	12%	82%	60%	29%	100%	-4%	9%	2%	3%	6%	4%	-3%	-9%
CA	13%	12%	-2%	0%	-2%	-4%	100%	28%	33%	54%	23%	31%	3%	7%
ID	4%	3%	14%	5%	10%	9%	28%	100%	15%	13%	44%	13%	8%	-4%
Portland	1%	12%	2%	5%	9%	2%	33%	15%	100%	71%	28%	58%	16%	5%
OR Other	-2%	13%	4%	7%	6%	3%	54%	13%	71%	100%	28%	64%	15%	8%
UT	-3%	0%	9%	4%	9%	6%	23%	44%	28%	28%	100%	24%	31%	-1%
WA	-3%	7%	9%	14%	17%	4%	31%	13%	58%	64%	24%	100%	15%	0%
WY	1%	2%	-4%	1%	-1%	-3%	3%	8%	16%	15%	31%	15%	100%	-2%
Hydro	-1%	-6%	-13%	-3%	1%	-9%	7%	-4%	5%	8%	-1%	0%	-2%	100%

SHORT-TERM SUMMER CORRELATIONS

	K-O	SUMAS	4C	COB	Mid-C	PV	CA	ID	Portland	OR Other	UT	WA	WY	Hydro
K-O	100%	89%	7%	5%	2%	8%	-3%	9%	5%	6%	2%	2%	1%	-5%
SUMAS	89%	100%	8%	8%	0%	10%	-6%	4%	9%	6%	-3%	2%	-5%	-1%
4C	7%	8%	100%	49%	44%	86%	20%	17%	16%	21%	28%	19%	4%	-2%
COB	5%	8%	49%	100%	74%	52%	11%	18%	27%	27%	19%	25%	-2%	-9%
Mid-C	2%	0%	44%	74%	100%	44%	17%	22%	25%	26%	24%	27%	8%	-9%
PV	8%	10%	86%	52%	44%	100%	19%	17%	17%	23%	25%	18%	4%	-7%
CA	-3%	-6%	20%	11%	17%	19%	100%	34%	35%	56%	29%	42%	8%	-7%
ID	9%	4%	17%	18%	22%	17%	34%	100%	13%	22%	39%	24%	27%	-10%
Portland	5%	9%	16%	27%	25%	17%	35%	13%	100%	76%	28%	61%	9%	-11%
OR Other	6%	6%	21%	27%	26%	23%	56%	22%	76%	100%	33%	78%	10%	-13%
UT	2%	-3%	28%	19%	24%	25%	29%	39%	28%	33%	100%	35%	32%	-13%
WA	2%	2%	19%	25%	27%	18%	42%	24%	61%	78%	35%	100%	11%	-15%
WY	1%	-5%	4%	-2%	8%	4%	8%	27%	9%	10%	32%	11%	100%	2%
Hydro	-5%	-1%	-2%	-9%	-9%	-7%	-7%	-10%	-11%	-13%	-13%	-15%	2%	100%

SHORT-TERM FALL CORRELATIONS

	K-O	SUMAS	4C	COB	Mid-C	PV	CA	ID	Portland	OR Other	UT	WA	WY	Hydro
K-O	100%	63%	22%	24%	22%	29%	9%	15%	10%	14%	15%	10%	9%	1%
SUMAS	63%	100%	13%	25%	26%	18%	20%	12%	21%	32%	11%	22%	24%	8%
4C	22%	13%	100%	33%	33%	77%	11%	16%	4%	10%	19%	11%	-7%	8%
COB	24%	25%	33%	100%	90%	38%	26%	12%	33%	37%	10%	31%	-2%	3%
Mid-C	22%	26%	33%	90%	100%	35%	26%	15%	35%	42%	8%	36%	0%	2%
PV	29%	18%	77%	38%	35%	100%	13%	16%	12%	16%	22%	20%	-2%	2%
CA	9%	20%	11%	26%	26%	13%	100%	26%	44%	69%	29%	55%	12%	5%
ID	15%	12%	16%	12%	15%	16%	26%	100%	17%	23%	30%	18%	1%	2%
Portland	10%	21%	4%	33%	35%	12%	44%	17%	100%	71%	47%	67%	27%	1%
OR Other	14%	32%	10%	37%	42%	16%	69%	23%	71%	100%	35%	75%	23%	5%
UT	15%	11%	19%	10%	8%	22%	29%	30%	47%	35%	100%	33%	28%	0%
WA	10%	22%	11%	31%	36%	20%	55%	18%	67%	75%	33%	100%	21%	2%
WY	9%	24%	-7%	-2%	0%	-2%	12%	1%	27%	23%	28%	21%	100%	10%
Hydro	1%	8%	8%	3%	2%	2%	5%	2%	1%	5%	0%	2%	10%	100%

CONCLUSION

For the continuous, stochastic variables that drive PacifiCorp's electricity environment short-term volatility and mean reversion, complete with corresponding correlations, provide a robust picture of the spread of future outcome. The standard parameters developed here can be used within the PaR model to develop PacifiCorp's Integrated Resource Plan.